

Owner's Manual

PowerVerter® PV1000HF, PV1800HF & PV3000HF DC-to-AC Inverters



1111 W. 35th Street, Chicago, IL 60609 USA
Customer Support: (773) 869-1234
www.tripplite.com

Input
12 VDC

Output
120V, 60 Hz. AC

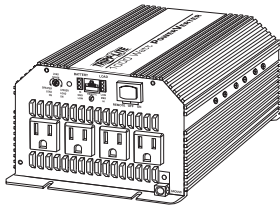

PV1000HF

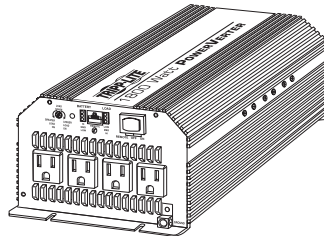

PV1800HF

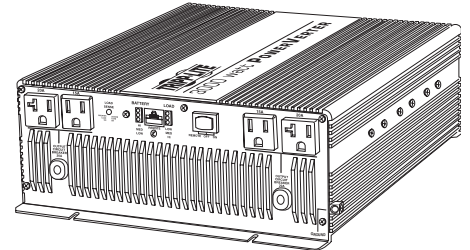

PV3000HF

Reliable AC Power Wherever You Need It!

Congratulations! You've purchased the most advanced, feature-rich Inverter designed as a mobile energy source for your vehicle. PowerVerter Inverters efficiently convert DC (battery) power into 120V AC (household) power, allowing you to use equipment you commonly use at home—appliances, entertainment systems, computers, power tools and more—while cruising the open road or out on the open water. PowerVerter Inverters, through a high-efficiency conversion process and a charge conservation setting, draw the highest level of performance from your batteries without overtaxing them, lengthening their service life. An automatic low battery shutdown feature ensures you'll always have plenty of power for starting purposes.

- **Automatic Overload Protection**
- **Automatic "Battery-Saver" Low Voltage Shutdown**
- **High Efficiency DC-to-AC Inversion**
- **Multi-Function Lights & Switches**
- **Optional Remote Control Capability**
(Module included with PV3000HF)

Register on-line today for a chance to win a FREE Tripp Lite product!
www.tripplite.com/warranty

Contents

Specifications	2	Application Guide	5
Safety	2	Mounting	6
Feature Identification	3	Battery Connection	7
Operation	4	Troubleshooting/Service/ Maintenance/Warranty	8 (back page)

Specifications

MODEL NUMBER:	PV1000HF	PV1800HF	PV3000HF
Continuous Power (@ 20° C):*	1000 Watts	1800 Watts	3000 Watts
Double Boost™ Peak Surge Power:*	2000 Watts	3600 Watts	6000 Watts
DC Input Volts (Nominal):	12 VDC	12 VDC	12 VDC
DC Input Voltage Range:	10 - 15 VDC	10 - 15 VDC	10.5 - 15 VDC
DC Input Connection:	User Supplied Cables	User Supplied Cables	User Supplied Cables
Output Volts (Nominal):	120 VAC	120 VAC	120 VAC
Output Frequency (Nominal):	60 Hz, ± 0.5%	60 Hz, ± 0.5%	60 Hz, ± 0.5%
Efficiency:	Up to 94%	Up to 94%	Up to 94%
Output Waveform:	Modified Sine Wave	Modified Sine Wave	Modified Sine Wave

* DoubleBoost duration (instantaneous). Actual output depends on battery age, battery charge level and ambient temperature. The policy of Tripp Lite is one of continuous improvement. Specifications are subject to change without notice.

Minimum Recommended Cable Sizing Chart†

Always loosely twist each pair of cables (one positive and one negative) together. Use in conjunction with DC wiring connection instructions in the Battery Connection section. Using 4 conductors is recommended (but not required) to obtain maximum output power from PV3000HF models.

Wire Gauge

Watts	2 Conductors (all models)				4 Conductors (PV3000HF only)	
	6	4	2	0	00	Twin 00
500	15 ft	25 ft	39 ft	62 ft	79 ft	158 ft
700	11 ft	18 ft	28 ft	44 ft	56 ft	112 ft
1000	N/R	12 ft	20 ft	31 ft	39 ft	78 ft
2000	N/R	N/R	N/R	16 ft	20 ft	40 ft
2400	N/R	N/R	N/R	13 ft	16 ft	32 ft
3000	N/R	N/R	N/R	10 ft	13 ft	26 ft

† N/R = Not Recommended. NOTE: Acceptable power is directly related to cable length (i.e. - the shorter the cable, the better the performance)

Tripp Lite Inverters include a Battery Charge Conserver (Load Sense) Control which saves battery power by allowing users to set the minimum load level at which the unit's inverter turns on. Users can significantly reduce the No Load DC Input Current to a very low amperage power level with the use of this control.

Important Safety Instructions



SAVE THESE INSTRUCTIONS!

This manual contains important instructions and warnings that should be followed during the installation, operation and storage of all Tripp Lite Inverters.

Location Warnings

- Install your Inverter in a location or compartment in your vehicle that minimizes exposure to heat, dust, direct sunlight and moisture. Flooding the unit with water will cause it to short circuit and could cause personal injury due to electric shock.
- Leave a minimum of 2" clearance at front and back of the Inverter for proper ventilation. To avoid overheating the Inverter, any compartment that contains the Inverter must be properly ventilated with adequate outside air flow. The heavier the load of connected equipment, the more heat will be generated by the unit.
- Do not install the Inverter directly near magnetic storage media, as this may result in data corruption.
- Do not install near flammable materials, fuel or chemicals.

Battery Connection Warnings

- Multiple battery systems must be comprised of batteries of identical voltage, age, amp-hour capacity and type.
- Because explosive hydrogen gas can accumulate near batteries if they are not kept well ventilated, your batteries should not be installed in a "dead air" compartment. Ideally, any compartment would have some ventilation to outside air.
- Sparks may result during final battery connection. Always observe proper polarity as batteries are connected.
- Do not allow objects to contact the DC input terminals. Do not short or bridge these terminals together. Serious personal injury or property damage could result.

Equipment Connection Warnings

• Do not use a Tripp Lite Inverter in life support or healthcare applications where a malfunction or failure of a Tripp Lite Inverter could cause failure of, or significantly alter the performance of, a life support device or medical equipment.

- You may experience uneven performance results if you connect a surge suppressor, line conditioner or UPS system to the output of the Inverter.

Operation Warnings

- Your Inverter does not require routine maintenance.
- Potentially lethal voltages exist within the Inverter as long as the battery supply is connected. During any service work, the battery supply should therefore be disconnected.
- Do not connect or disconnect batteries while the Inverter is operating from the battery supply. Dangerous arcing may result.

Feature Identification

Identify the premium features on your specific model and quickly locate instructions on how to maximize their use.

- 1 Operating Mode Switch:** controls Inverter operation. Set this 3-position rocker switch to “ON” to have your Inverter provide connected equipment with AC power by converting DC power from an attached battery. Set switch to “OFF” when not using connected equipment to prevent battery drain. Set switch to “REMOTE” to remotely monitor and control the Inverter with the use of an optional remote module.
 - 2 “LOAD” Indicator Lights:** intuitive “traffic light” signals show approximate equipment load level. See page 4 for instructions on reading indicator lights.
 - 3 “BATTERY” Indicator Lights:** intuitive “traffic light” signals show approximate charge level of your battery. See page 4 for instructions on reading indicator lights.
 - 4 DC Power Terminals:** connect to your battery terminals. See page 7 for connection instructions.
 - 5 AC Receptacles:** allow you to connect equipment that would normally be plugged into a utility outlet. PV3000HF models include two receptacles that accept either 15- or 20-amp plugs.
 - 6 Resettable Circuit Breaker(s):** protect your Inverter against damage due to overload. PV3000HF models include two separate 20-amp circuits. See page 4 for resetting instructions.
 - 7 Remote Control Module Connector:** allows remote monitoring and control with an optional module (Tripp Lite model APSRM2 or APSRM3, sold separately or included with PV3000HF models). See remote module owner’s manual for connection instructions.
 - 8 Battery Charge Conserver (Load Sense) Dial:** conserves battery power by setting the low-load level at which the Inverter automatically shuts off. See page 4 for setting instructions.
 - 9 Multi-Speed Cooling Fan(s):** quiet, efficient fans prolong equipment service life.
 - 10 Main Ground Lug:** properly grounds the Inverter to vehicle grounding system or earth ground. See page 7 for connection instructions.
- Low Battery Alarm/Shutdown (internal, not shown):** automatically detects low voltage and shuts down Inverter to preserve vehicle battery.
- Overload Alarm/Shutdown (internal, not shown):** automatically detects wattage overload on Inverter outlets and shuts down Inverter as a protective measure.

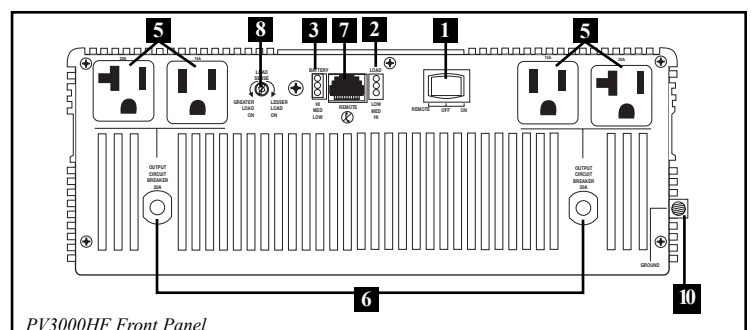
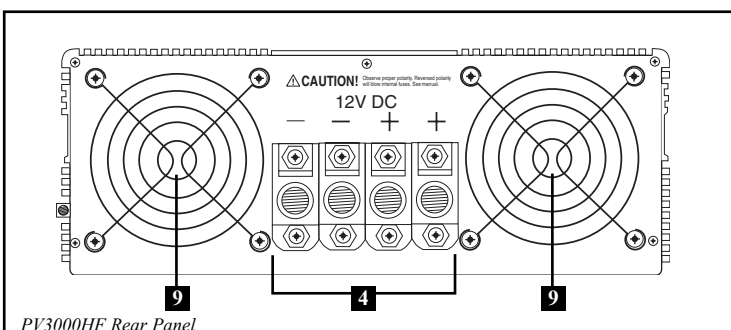
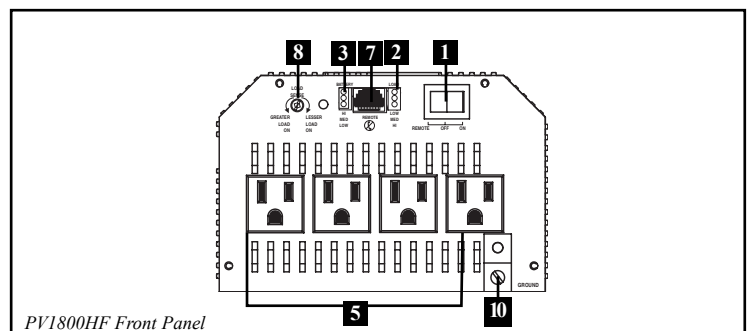
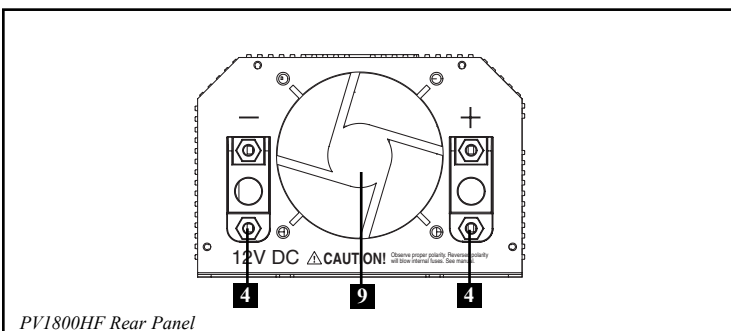
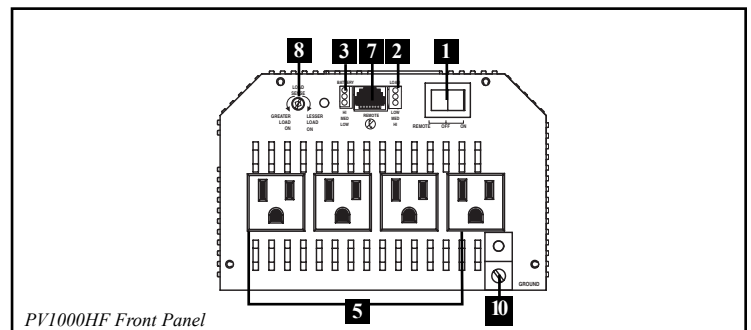
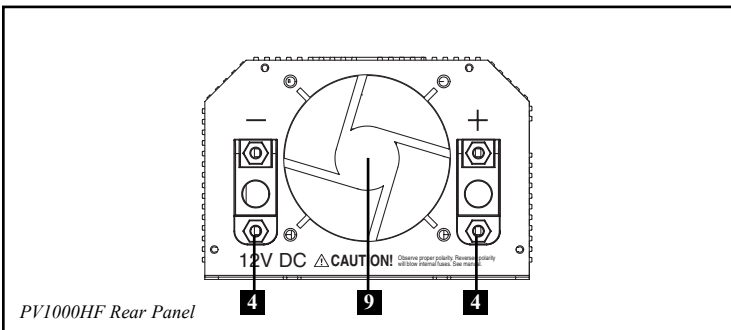

Operation

Switch Modes

Switch between the following operating modes as appropriate to your situation:

“ON”: Switch to this setting to provide connected equipment with AC power.

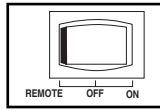

“OFF”: Switch to this setting to shut down the Inverter completely, preventing it from drawing power from the batteries. Use this switch to automatically reset the unit if it shuts down due to low battery or overload.

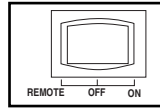

Use an optional remote control module (Tripp Lite model APSRM2 or APSRM3, sold separately or included with PV3000HF models) to reset unit due to overload only.

“REMOTE”: Switch to this setting to remotely monitor and control the Inverter with the use of an optional remote module. See remote module’s owner’s manual for operating instructions.

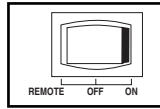

Indicator Lights

Your Inverter is equipped with a simple, intuitive, user-friendly set of indicator lights. These easily-remembered “traffic light” signals will allow you, shortly after first use, to tell at a glance the charge condition of your batteries, as well as ascertain approximate equipment load level.

“BATTERY” Indicator Lights: These three lights will illuminate in several sequences to show the approximate charge level of your connected battery:

Approximate Battery Charge Level†

Indicator Illuminated	Battery Capacity
1 Green	91%–Full
2 Green & Yellow	81%–90%
3 Yellow	61%–80%
4 Yellow & Red	41%–60%
5 Red	21%–40%
6 Flashing Red (slowly)*	1%–20%
7 Flashing Red (quickly)**	0% (Inverter has shutdown)

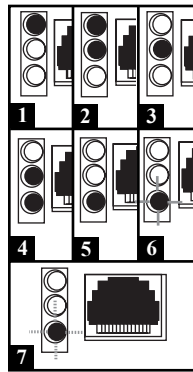

“LOAD” Indicator Lights: These three lights will illuminate in several sequences to show the approximate equipment load level on the Inverter’s AC receptacles.

Approximate Equipment Load Level

Indicator Illuminated	Load Level
1 Green	0%–50%
2 Green & Yellow	51%–75%
3 Yellow	76%–90%
4 Red	≥ 90%
5 Flashing Red (quickly)**	OVERLOAD (Inverter has shutdown)

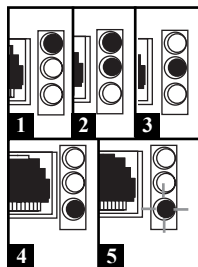

† Charge levels listed are approximate. Actual conditions vary depending on battery condition and load. * Approximately ½ second on, ½ second off. ** Approximately ¼ second on, ¼ second off. See “Resetting Your Inverter to Restore AC Power” to reset after Inverter shut down.

Resetting Your Inverter to Restore AC Power

Your Inverter may cease supplying AC power in order to protect itself from overload or to protect your electrical system. To restore normal functioning:

Low Battery Shutdown Reset: Set operating mode switch to “OFF” and run vehicle engine to recharge battery. When battery is adequately charged, switch operating mode switch back to either “REMOTE” or “ON.”

Overload Shutdown Reset: Set operating mode switch to “OFF” and remove some of the connected electrical load (ie: turn off some of the AC devices drawing power which may have caused the overload of the unit). Wait one minute, then switch operating mode switch back to either “REMOTE” or “ON.”

Output Circuit Breaker Reset (Select Models): Alternatively, check output circuit breaker(s) on the unit's front panel. If tripped, remove some of the electrical load, then wait one minute to allow components to cool before resetting the circuit breaker. See Troubleshooting for other possible reasons AC output may be absent.

Set Battery Charge Conserver (Load Sense) Dial

In order to save battery power, the Inverter automatically shuts off in the absence of any power demand from connected equipment or appliances (the electrical load). When the unit detects a load, it automatically turns on. Users may choose the minimum load the Inverter will detect by adjusting the Battery Charge Conserver Dial (see diagram). Using a small tool, turn the dial clockwise to lower the minimum load that will be detected, causing the Inverter to turn on for smaller loads. When the dial is turned fully clockwise, the Inverter will operate even when there is no load. Turn the dial counterclockwise to set a higher minimum load, causing the Inverter to stay off until the new minimum load is reached. When the dial is turned fully counterclockwise, the Inverter will turn on when it detects any load greater than approximately 150 Watts.

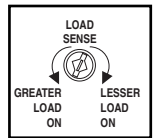

Note: The factory setting for the dial is fully clockwise. However, based on the threshold load to which you'd like the Inverter to respond, you should adjust the dial counterclockwise to reduce its sensitivity until the Inverter is active only when connected equipment or appliances are actually in use.

Connect Remote Control—OPTIONAL (included with PV3000HF)

All models feature an 8-conductor telephone style receptacle on the front panel for use with an optional remote control module (Tripp Lite model APSRM2 or APSRM3, sold separately or included with PV3000HF models). The remote module allows the Inverter to be mounted in a compartment or cabinet out of sight, while operated conveniently from your vehicle’s dashboard. See instructions packed with the remote control module.



Application Guide

Match Battery Amp-Hour Capacity to Your Application



Select a battery or system of batteries that will provide your Inverter with proper DC voltage and an adequate amp-hour capacity to power your application. Even though Tripp Lite Inverters are highly efficient at DC-to-AC inversion, their rated output capacities are limited by the total amp-hour capacity of connected batteries and the support of your vehicle's alternator if the engine is kept running.

Example

Tools

 1/4" Drill	 Orbital Sander	 Cordless Tool Charger	=	540W	
300W	+	220W	+	20W	

Appliances

 Blender	 Color TV	 Laptop Computer	=	540W	
300W	+	140W	+	100W	

- **STEP 1: Determine Total Wattage Required**

Add the wattage ratings of all equipment you will connect to your Inverter. Wattage ratings are usually listed in equipment manuals or on nameplates. If your equipment is rated in amps, multiply that number times AC utility voltage to determine watts. (Example: a 1/4 in. drill requires 2 1/2 amps. 2 1/2 amps × 120 volts = 300 watts.)

Note: Your Inverter will operate at higher efficiencies at about 75% - 80% of nameplate rating.

- **STEP 2: Determine DC Battery Amps Required**

Divide the total wattage required (from step 1, above) by the battery voltage (12) to determine the DC amps required.

$$540 \text{ watts} \div 12V = 45 \text{ DC Amps}$$

- **STEP 3: Estimate Battery Amp-Hours Required** (for operation unsupported by the alternator)

Multiply the DC amps required (from step 2, above) by the number of hours you estimate you will operate your equipment exclusively from battery power before you have to recharge your batteries. Compensate for inefficiency and wiring losses by multiplying this number by 1.2. This will give you a rough estimate of how many amp-hours of battery power (from one or several batteries) you should connect to your Inverter.

NOTE: Battery amp-hour ratings are usually given for a 20-hour discharge rate. Actual amp-hour capacities are less when batteries are discharged at faster rates. For example, batteries discharged in 55 minutes provide only 50% of their listed amp-hour ratings, while batteries discharged in 9 minutes provide as little as 30% of their amp-hour ratings.

$$45 \text{ DC Amps} \times 5 \text{ Hrs. Runtime} \\ \times 1.2 = 270 \text{ Amp-Hours}$$

You must allow your batteries to recharge long enough to replace the charge lost during Inverter operation or else you will eventually run down your batteries.

NOTE: For Tripp Lite Inverters over 1000 watts used in mobile applications, Tripp Lite recommends you use at least two batteries, if possible, fed by a heavy-duty alternator anytime the vehicle is running. Tripp Lite Inverters will provide adequate power for ordinary usage within limited times without the assistance of your vehicle's alternator. However, when operating extremely heavy electrical loads at their peak, you may wish to "assist your batteries" by running your vehicle engine faster than normal idling.

Mounting *optional*



WARNING! If you choose to mount your Inverter, mount it and wire its DC input **BEFORE** DC battery connection. Failure to follow these instructions may lead to personal injury and/or damage to the Inverter and connected systems.

Tripp Lite Inverters are designed for horizontal mounting in a variety of vehicular or non-vehicular applications. User must supply mounting hardware and is responsible for determining if the hardware and mounting surface are suitable to support the weight of the Inverter. Contact Tripp Lite if you require further assistance in mounting your Inverter.

Vehicular and Non-Vehicular Horizontal Mount

Install and tighten four user-supplied fasteners through Inverter mounting slots and into a rigid horizontal surface. Install fasteners as far back in the mounting slots as possible, otherwise the Inverter may slide back and forth if fasteners loosen.

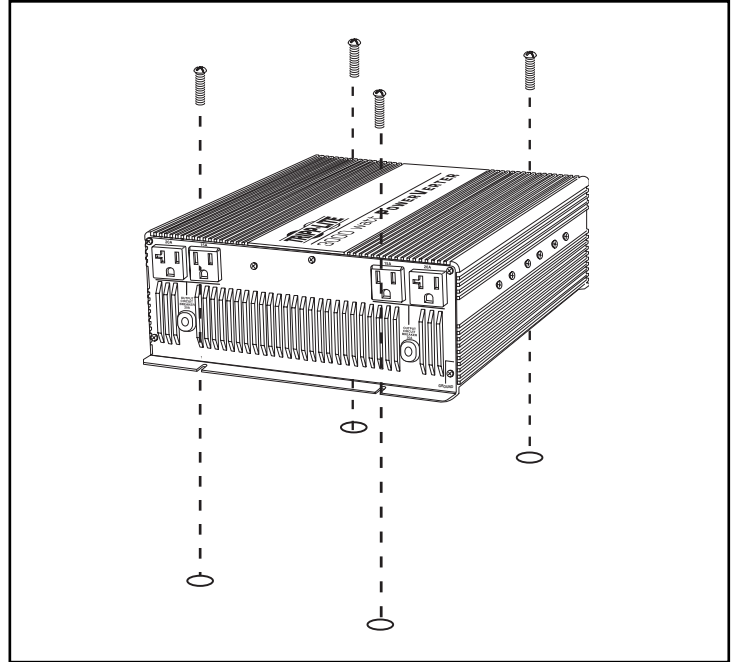

Battery Connection

Connect your Inverter to your batteries using the following procedures—always loosely twist each pair of cables (one positive and one negative) together:

• Connect DC Wiring:

Connection to Two DC Terminals

PV1000HF and PV1800HF models include two DC terminals; PV3000HF models include four DC terminals (two positive and two negative). For PV3000HF models, it is acceptable to use only one set of cables to connect your battery to only one positive and one negative DC terminal, however, your PV3000HF may provide reduced output power. It doesn't make a difference which positive and negative terminal you choose for the connection because both positive terminals are internally bonded and both negative terminals are also internally bonded.

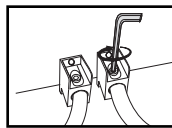

PV1000HF
PV1800HF

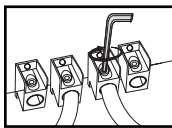

PV3000HF

Regardless of the model, you must run positive cable(s) through user-supplied UL-listed fuse(s) and fuse block(s) of the proper size: PV1000HF—175 amp fuse, PV1800HF—250 amp fuse, PV3000HF—500 amp fuse.

See Specifications page for Minimum Recommended Cable Sizing Chart. An excellent source of cables are battery jumper cables. Output performance will decrease if you use only one jumper cable.

Connection to Four DC Terminals

To obtain maximum output power from PV3000HF models, it is recommended (but not required) that you use four 00 gauge cables to connect your battery to all four DC terminals. In this connection you must run two positive cables of equal length through two user-supplied UL-listed 250-amp fuses and fuse blocks. Use the equivalent of two 00 cables in all other connections within the battery system.

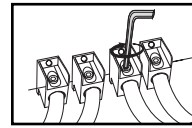

PV3000HF

Length & Gauge of Cables

Although your Inverter is a high-efficiency converter of electricity, its rated output capacity is limited by the length and gauge of the cabling running from the battery to the unit. Use the shortest length and largest diameter cabling (maximum 00 gauge) to fit your Inverter's DC Input terminals. Shorter and heavier gauge cabling reduces DC voltage drop and allows for maximum transfer of current. Your Inverter is capable of delivering peak wattage at up to 200% of its rated continuous wattage output for brief periods of time. See Specifications page for details.

Heavier gauge cabling should be used when continuously operating heavy draw equipment under these conditions. Tighten your Inverter and battery terminals to approximately 3.5 Newton-meters (2.58 foot lbs.) of torque to create an efficient connection and to prevent excessive heating at this connection. Insufficient tightening of the terminals could void your warranty.

• **Connect Ground:** Using a #8 AWG wire or larger, directly connect the Main Ground Lug to the vehicle's chassis ground or earth ground. See Feature Identification section to locate Main Ground Lug. All installations must comply with national and local codes and ordinances.

• **Connect Fuse:** In addition to the protection provided by the Inverter's internal fuses, NEC article 551 requires that you connect your Inverter's positive DC Terminal(s) directly to a UL-listed fuse(s) and fuse block(s) within 18 inches of the battery. See diagrams below for proper fuse placement.



WARNING! Never attempt to operate your Inverter by connecting it directly to output from an alternator rather than a battery or battery bank.

CAUTION! Observe proper polarity with all DC connections. If polarity is reversed, the Inverter's 40-amp internal fuses will blow. To access internal fuses, disconnect all equipment and batteries from the Inverter. Then, unscrew and remove front panel; slide out bottom panel to access fuses. Replace blown fuses with an equal number of new fuses of the same type and amperage. Replace front panel and screws.

Vehicular

Your Inverter's Nominal DC Input Voltage **must match** the voltage of your battery or batteries—12 Volts in most vehicular applications. It is possible to connect your Inverter to the main battery within your vehicle's electrical system. In many vehicular contexts, the Inverter will be connected to one or more dedicated auxiliary (house) batteries which are isolated from the drive system to prevent possible draining of the main battery.

- 1 12 Volt Alternator
- 2 Vehicle Battery Ground
- 3 12 Volt Main Battery
- 4 12 Volt Auxiliary (House) Battery
- 5 UL-Listed Fuses & Fuse Blocks (mounted within 18 inches of the battery)
- 6 Battery Isolator
- 7 Large Diameter Cabling, Maximum 00 Gauge to Fit Terminals
- 8 8 AWG (minimum) Ground Wire

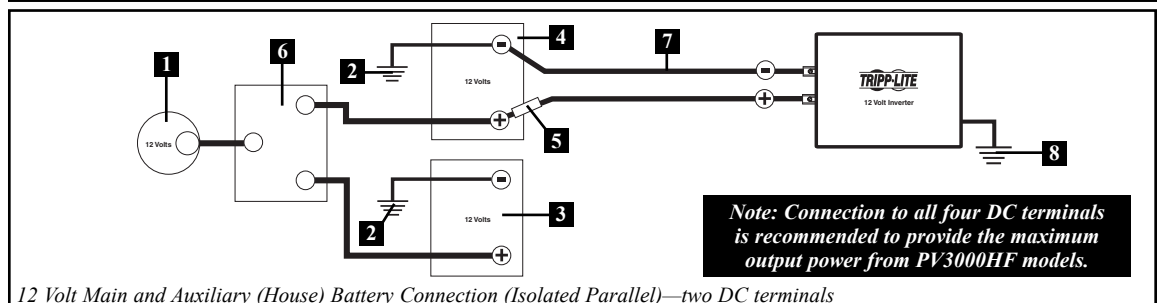
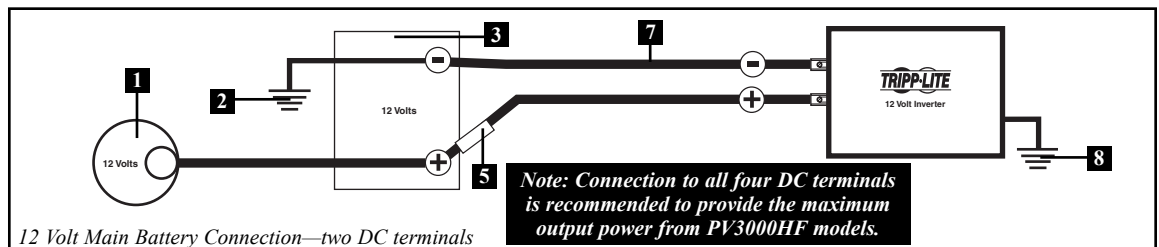

Troubleshooting

Try these remedies for common Inverter problems before calling for assistance. Call Tripp Lite Customer Service at (773) 869-1234 before returning your unit for service.

Operating Mode Switch

Battery Indicator Lights

Load Indicator Lights

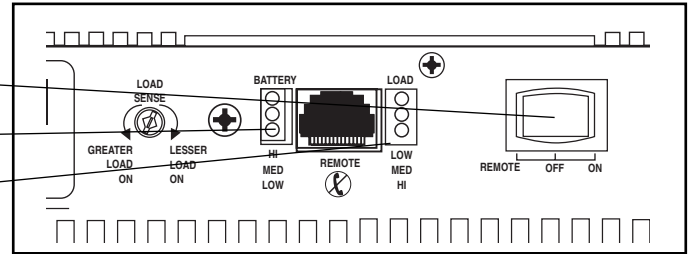

SYMPTOM	PROBLEMS	CORRECTIONS
No AC Output (All Indicator Lights Are OFF)	Operating Mode Switch is set to "OFF."	Set Operating Mode Switch to "REMOTE" or "ON."
	User-supplied UL-listed external DC input fuses have blown.	Replace fuses.
Red Battery Indicator Light Is Rapidly Flashing (¼ Second Flashes)	Unit has shut down due to excessive battery discharge.	Run your engine to raise battery voltage. Check external battery connections and fuse. Reset by moving Operating Mode Switch to "OFF." Wait one minute and switch to "REMOTE" or "ON." If unit remains in shutdown mode after several attempts to reset contact Tripp Lite Customer Service for assistance.
Red Load Indicator Light Is Rapidly Flashing (¼ Second Flashes)	Unit has shut down due to overload.	Reduce load. Reset by moving Operating Mode Switch to "OFF." Wait one minute and switch to "REMOTE" or "ON." If unit remains in shutdown mode after several attempts to reset contact Tripp Lite Customer Service for assistance.
Connected Equipment Experiences Buzzing Sound Or Picture Distortion	Audio/Video interference.	Reposition equipment antennas and Inverter.
Inverter Output Seems Intermittent	Loose cable connections.	Check and secure all connections.

Service

If you are returning your Inverter to Tripp Lite, please pack it carefully, using the ORIGINAL PACKING MATERIAL that came with the unit. Enclose a letter describing the symptoms of the problem. If the Inverter is within the warranty period, enclose a copy of your sales receipt. To obtain service you must obtain a Returned Material Authorization (RMA) number from Tripp Lite or an authorized Tripp Lite service center.

Maintenance

Your Inverter requires no maintenance and contains no user-serviceable or replaceable parts, but should be kept dry at all times. Periodically check, clean and tighten all cable connections, as necessary, both at the unit and at the battery.

Limited Warranty

Tripp Lite warrants its Inverters to be free from defects in materials and workmanship for a period of one year (domestic) or 120 days (export) from the date of retail purchase by end user.

Tripp Lite's obligation under this warranty is limited to repairing or replacing (at its sole option) any such defective products. To obtain service under this warranty you must obtain a Returned Material Authorization (RMA) number from Tripp Lite or an authorized Tripp Lite service center. Products must be returned to Tripp Lite or an authorized Tripp Lite service center with transportation charges prepaid and must be accompanied by a brief description of the problem encountered and proof of date and place of purchase. This warranty does not apply to equipment which has been damaged by accident, negligence or misapplication or has been altered or modified in any way, including opening of the unit's casing for any reason. This warranty applies only to the original purchaser who must have properly registered the product within 10 days of retail purchase.

EXCEPT AS PROVIDED HEREIN, TRIPP LITE MAKES NO WARRANTIES, EXPRESS OR IMPLIED, INCLUDING WARRANTIES OF MERCHANTABILITY AND FITNESS FOR A PARTICULAR PURPOSE. Some states do not permit limitation or exclusion of implied warranties; therefore, the aforesaid limitation(s) or exclusion(s) may not apply to the purchaser.

EXCEPT AS PROVIDED ABOVE, IN NO EVENT WILL TRIPP LITE BE LIABLE FOR DIRECT, INDIRECT, SPECIAL, INCIDENTAL OR CONSEQUENTIAL DAMAGES ARISING OUT OF THE USE OF THIS PRODUCT, EVEN IF ADVISED OF THE POSSIBILITY OF SUCH DAMAGE. Specifically, Tripp Lite is not liable for any costs, such as lost profits or revenue, loss of equipment, loss of use of equipment, loss of software, loss of data, costs of substitutes, claims by third parties, or otherwise.

Tripp Lite has a policy of continuous improvement. Specifications are subject to change without notice.