

4

3

2

1

THIS DRAWING IS UNPUBLISHED. RELEASED FOR PUBLICATION 2008
 © COPYRIGHT 2008 BY TYCO ELECTRONICS CORPORATION. ALL RIGHTS RESERVED.

LOC	DIST	REVISIONS			
P	LTR	DESCRIPTION	DATE	DWN	APVD
E	B	BA	NEW RELEASE	30-Jul-08	SM St.P

- 1 AVAILABLE IN DIFFERENT SHAFT LENGTHS (L) SEE DATA SHEET
- 2 FOR FURTHER INFORMATION SEE DATA SHEET FOR 23 SERIES-SPINDLE OPERATED POTENTIOMETER

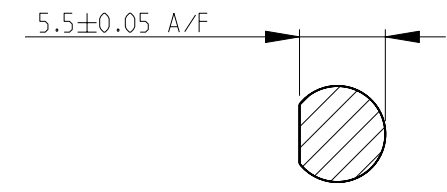
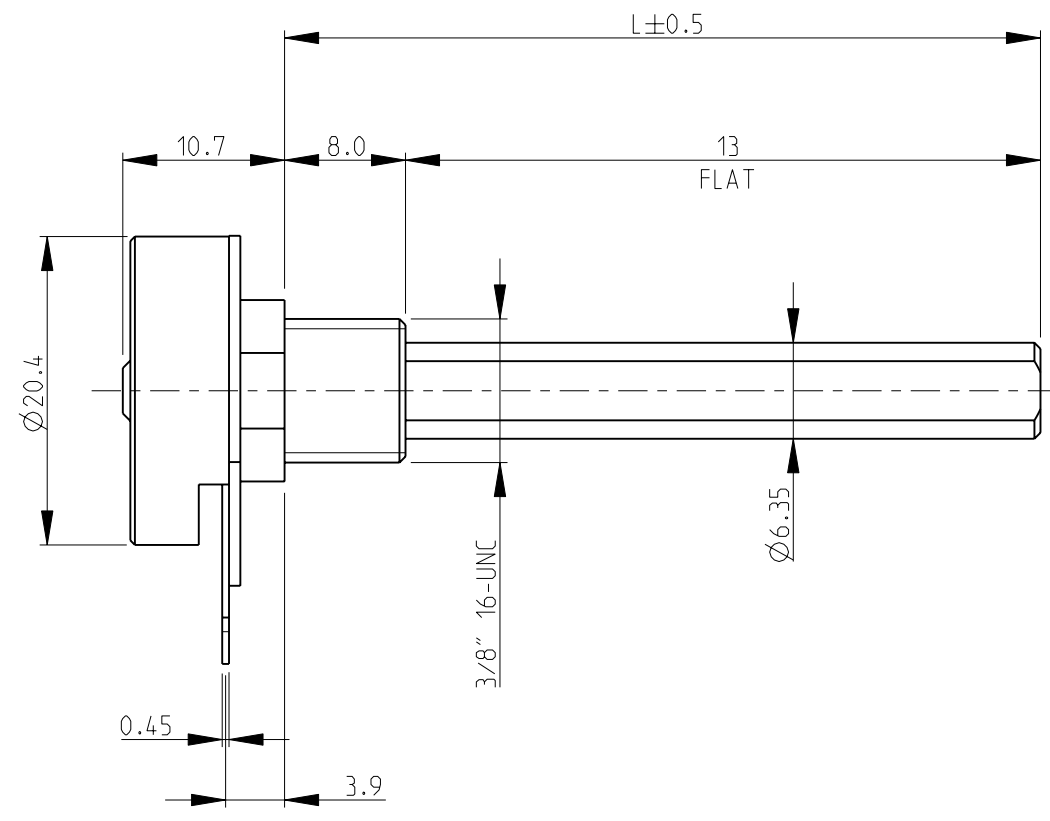
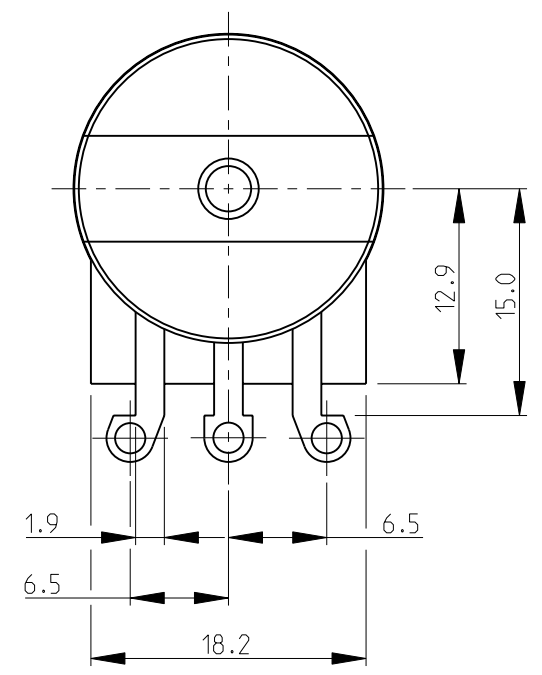

RoHS Compliant

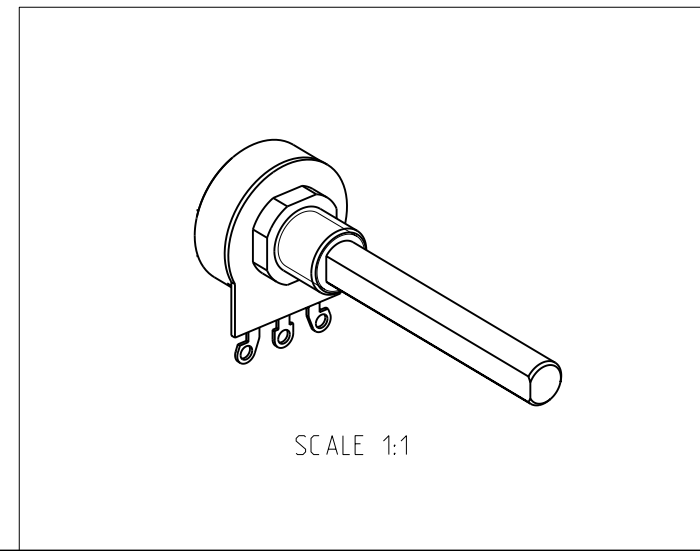

<small>THIS DRAWING IS A CONTROLLED DOCUMENT FOR TYCO ELECTRONICS CORPORATION IT IS SUBJECT TO CHANGE AND THE CONTROLLING ENGINEERING ORGANIZATION SHOULD BE CONTACTED FOR THE LATEST REVISION.</small>		DWN SUBHASH.M 30-Jul-08 CHK PRAKASH.S 30-Jul-08 APVD STEPHEN.P 30-Jul-08	Tyco Electronics Tyco Electronics Corporation Dorcan, Swindon, SN3 5HH		
DIMENSIONS: mm	TOLERANCES UNLESS OTHERWISE SPECIFIED: 0 PLC ±0.5 1 PLC ±0.2 2 PLC ±0.1 3 PLC ±- 4 PLC ±- ANGLES ±5°	PRODUCT SPEC - APPLICATION SPEC - WEIGHT -	NAME SPINDLE OPERATED POTENTIOMETER SERIES 23E		
MATERIAL -	FINISH -	SIZE A3	CAGE CODE 00779	DRAWING NO. 1624163	RESTRICTED TO -
CUSTOMER DRAWING			SCALE 2:1	SHEET 1 OF 1	REV BA