

LSK-120001Ax (x for Actuator Length)

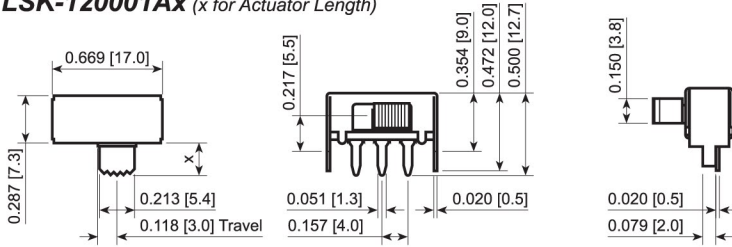

Suggested PCB Layout

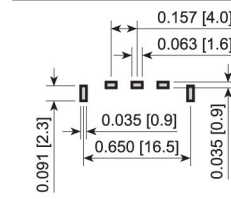

Electrical Schematic

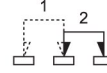

FEATURES:

- Compact Size With Multiple Functions
- RoHS and Lead Free Compliant
- Customizable Actuator Height

SPECIFICATIONS:

RATING: 0.5A 50VDC
TEMPERATURE: -30°C to 105°C
ELECTRICAL LIFE: 10,000 Cycles
CONTACT RESISTANCE: 30mΩ Max.
INSULATION RESISTANCE: 500MΩ Min. at 500VDC
DIELECTRIC STRENGTH: 500VAC for 1 Minute

MATERIALS:

Body: Steel
ACTUATOR: Polyoxymethylene
BASE: Phenolic Board
CONTACTS: Silver Plated Copper
TERMINALS: Silver Plated Brass

LSK-220001Ax (x for Actuator Length)

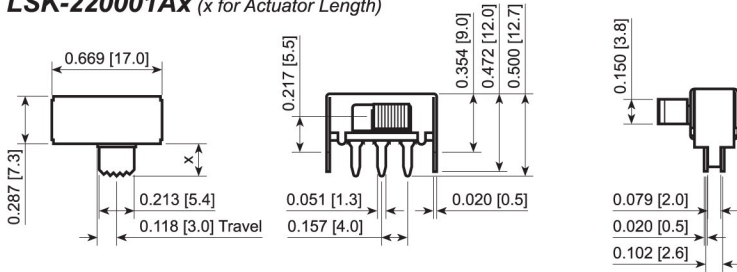

Suggested PCB Layout

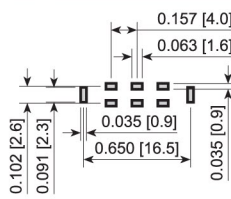

Electrical Schematic

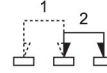

LSK-130101Ax (x for Actuator Length)

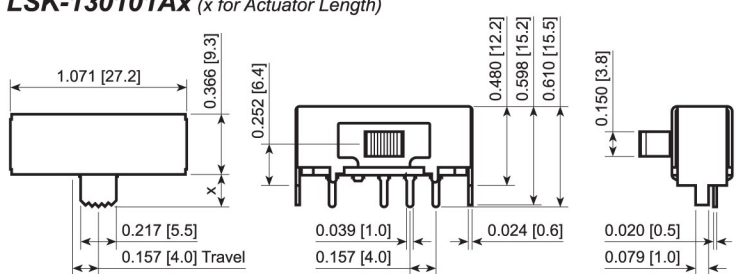

Suggested PCB Layout

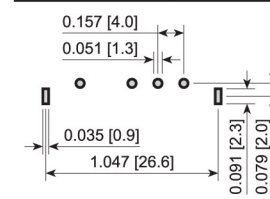

Electrical Schematic

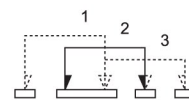

LSK-220001A7

LSK-230101Ax (x for Actuator Length)

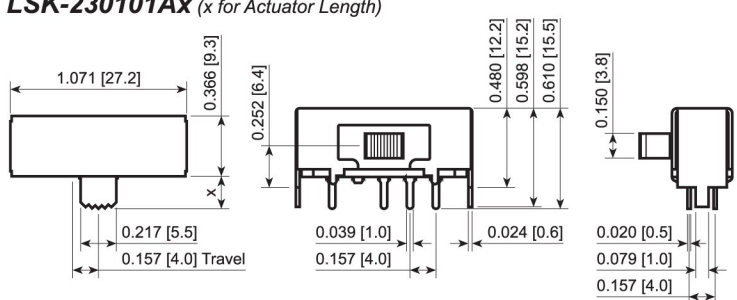

Suggested PCB Layout

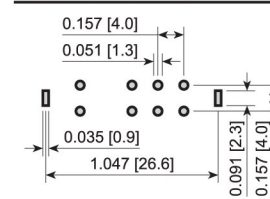

Electrical Schematic

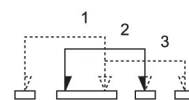

LSK-230101A7

Series	Number of Poles / Positions	Model	Terminal Type	Actuator Type	Actuator Height
LSK - Side Knob	For Model 00: 12 - 1 Pole, On-On 22 - 2 Pole, On-On	000 - 17.0 x 7.3 010 - 27.2 x 9.3	1 - PCB Pin	A - Rounded Ridged	5 - 5mm (Standard) X - Varies From 2 to 20
	For Model 01: 13 - 1 Pole, On-On-On 23 - 2 Pole, On-On-On				

EXAMPLE PART NUMBERS:

- LSK-120001A5 1P2T On-On
Model 000, PCB Pins, 5.0mm Actuator
- LSK-130101A5 1P3T On-On-On
Model 010, PCB Pins, 5.0mm Actuator
- LSK-220001A5 2P2T On-On
Model 000, PCB Pins, 5.0mm Actuator
- LSK-230101A5 2P3T On-On-On
Model 010, PCB Pins, 5.0mm Actuator