

SPECIFICATION

- Part No. : **MA672.A.CGH.003**
- Product Name : Spartan Antenna 3in1 MA672
 Low Profile Screw-Mount (Permanent Mount)
 3 * MIMO 5.0 ~ 5.8GHz antenna
 2 x vertically polarized elements
 1 x horizontally polarized element
- Feature : IP67 Waterproof
 High Efficiency / Peak Gain Outdoor Antenna
 Advanced RF Design and Materials
 Standard 3M CFD-200 RP-SMA(M)
 RoHS Compliant



1. Introduction

The Spartan MA672 5.0~5.8GHz 3*MIMO antenna is a low profile, heavy-duty, fully IP67 waterproof external M2M antenna for use in remote monitoring and telematics applications.

The Spartan is unique in the market because it combines three 5.0~5.8GHz antenna elements, heavy-duty antenna with high efficiency in a low profile compact format. The antenna screws down permanently onto a roof or metal panel and can be pole or wall-mounted. Two of the antenna elements are vertically polarized and one is horizontally polarized to enable diversity gain and improve MIMO throughput.

For industries such as remote monitoring, smart meter systems, construction equipment, public safety at only 40mm high, the Spartan provides an unobtrusive, robust, rugged antenna that is durable even in extreme environments.

2. Specification

ELECTRICAL - V-pol. antenna 1					
Frequency	5.0	5.3	5.6	5.8	GHz
Radiation Efficiency *	39.0	41.7	43.5	40.7	%
Peak Gain *	2.65	3.92	4.71	4.48	dBi
VSWR	2 Max				
Polarization	Linear (Vertical)				
Impedance	50				Ω

ELECTRICAL - V-pol. antenna 2					
Frequency	5.0	5.3	5.6	5.8	GHz
Radiation Efficiency *	44.7	42.8	41.3	35.1	%
Peak Gain *	3.44	3.50	4.01	3.53	dBi
VSWR	2 Max				
Polarization	Linear (Vertical)				
Impedance	50				Ω

ELECTRICAL - H-pol. antenna					
Frequency	5.0	5.3	5.6	5.8	GHz
Radiation Efficiency *	42.4	42.7	36.8	44.2	%
Peak Gain *	4.55	4.33	4.51	4.84	dBi
VSWR	2 Max				
Polarization	Linear (Horizontal)				
Impedance	50				Ω

MECHANICAL	
Antenna Dimensions	Height 35.1mm x Diameter 150mm
Casing	PC
Base and thread	Nickel Plated Zinc
Waterproof	IP67
ENVIRONMENTAL	
Temperature Range	-40°C to 85°C
Humidity	Non-condensing 65°C 95% RH

* all measurements were conducted with 3m CFD200 cable

3. Return Loss

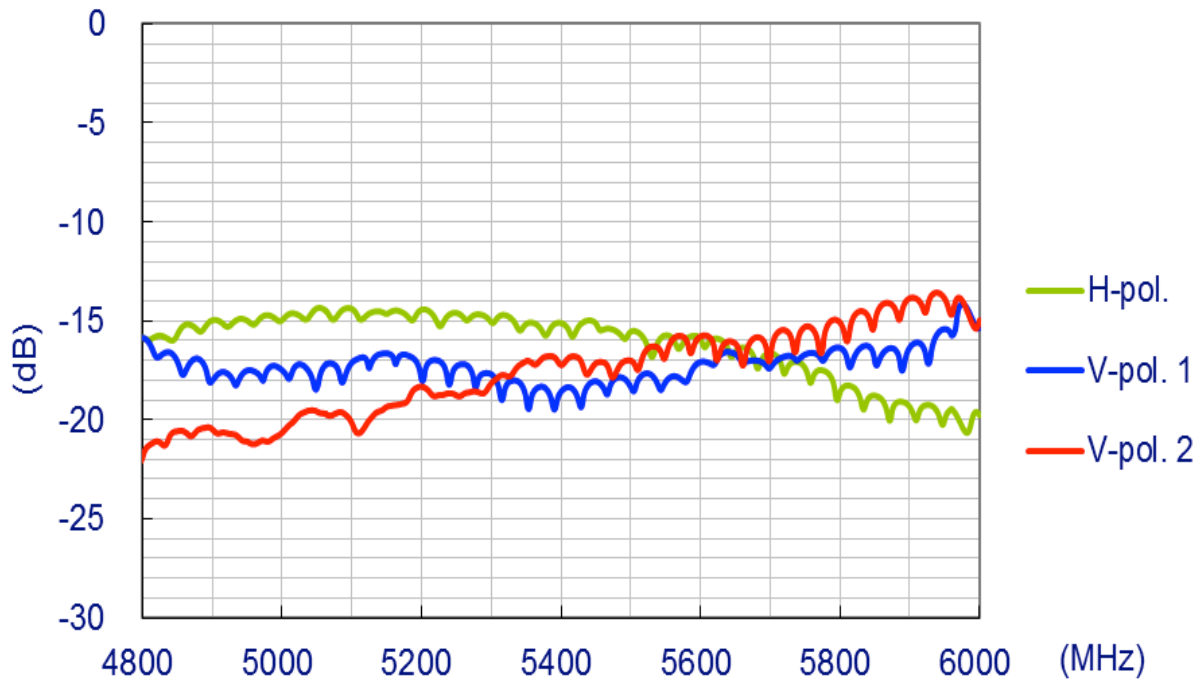

4. Maximum Gain

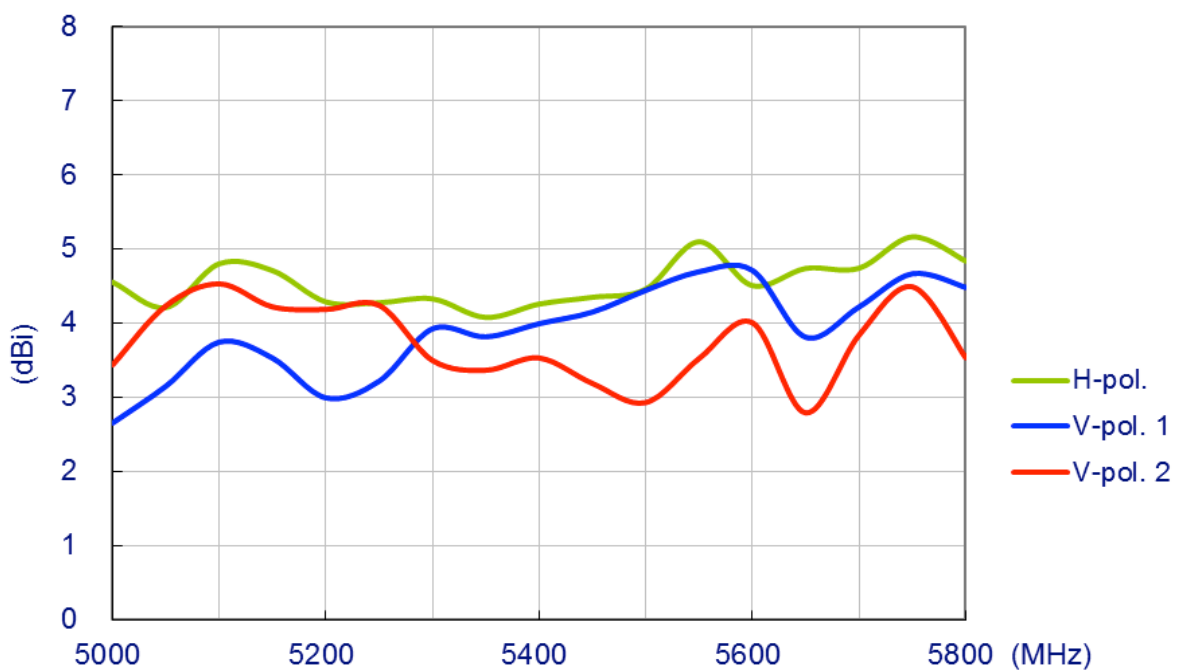

5. Average Gain

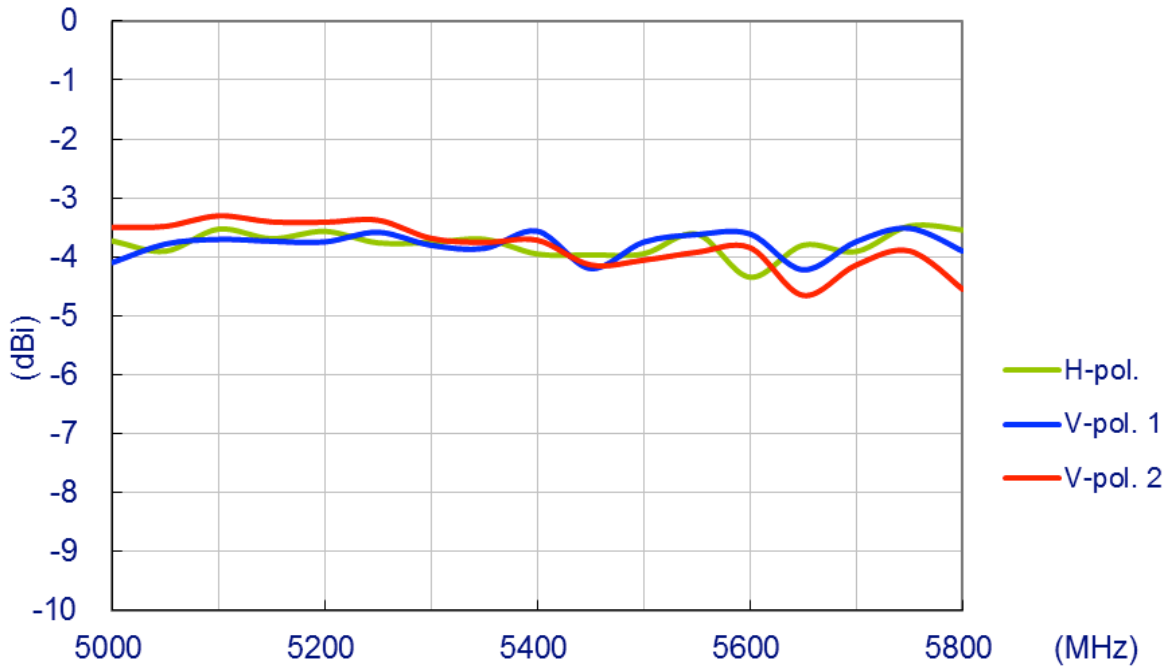

6. Efficiency

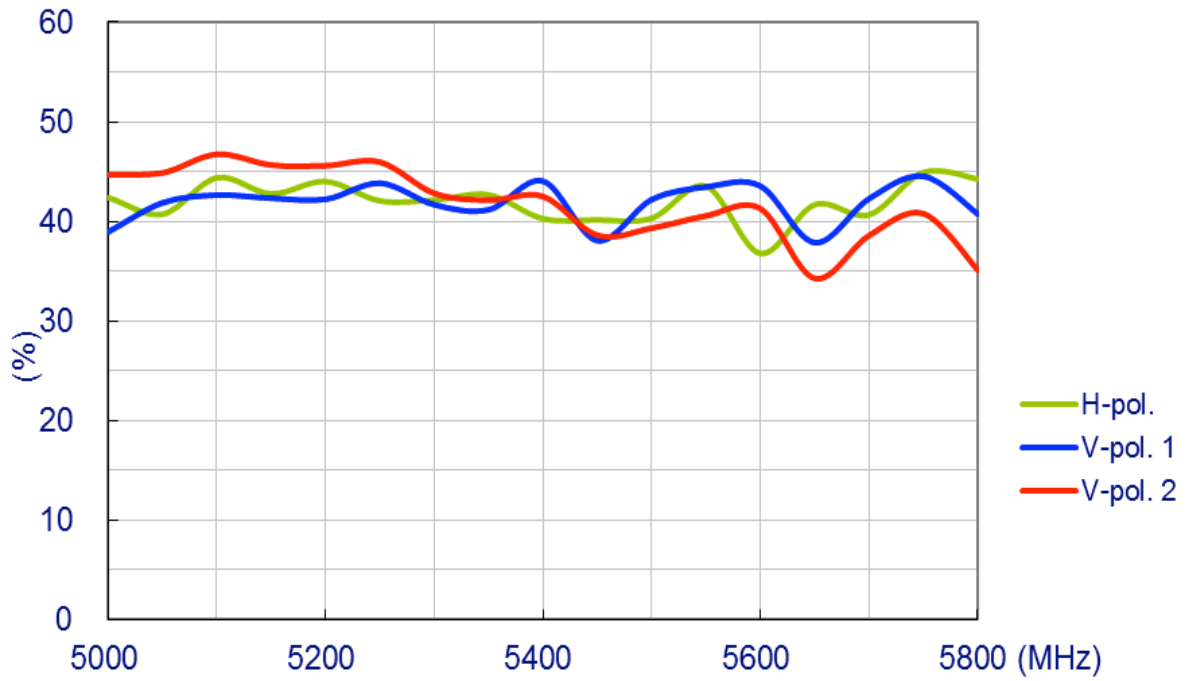

7. Antenna Radiation Patterns

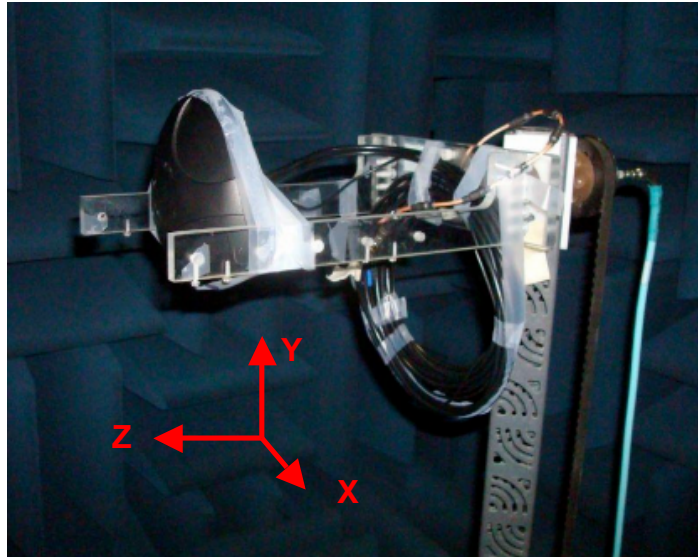

MA. 672 tested in CTIA approved 3D chamber

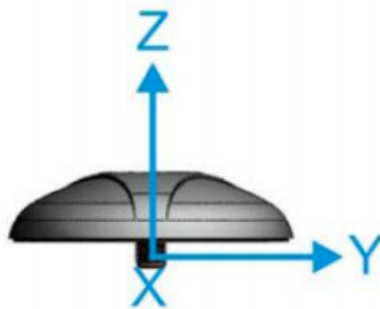

XYZ coordinates for reference

7.1 H-pol. antenna

XY plane

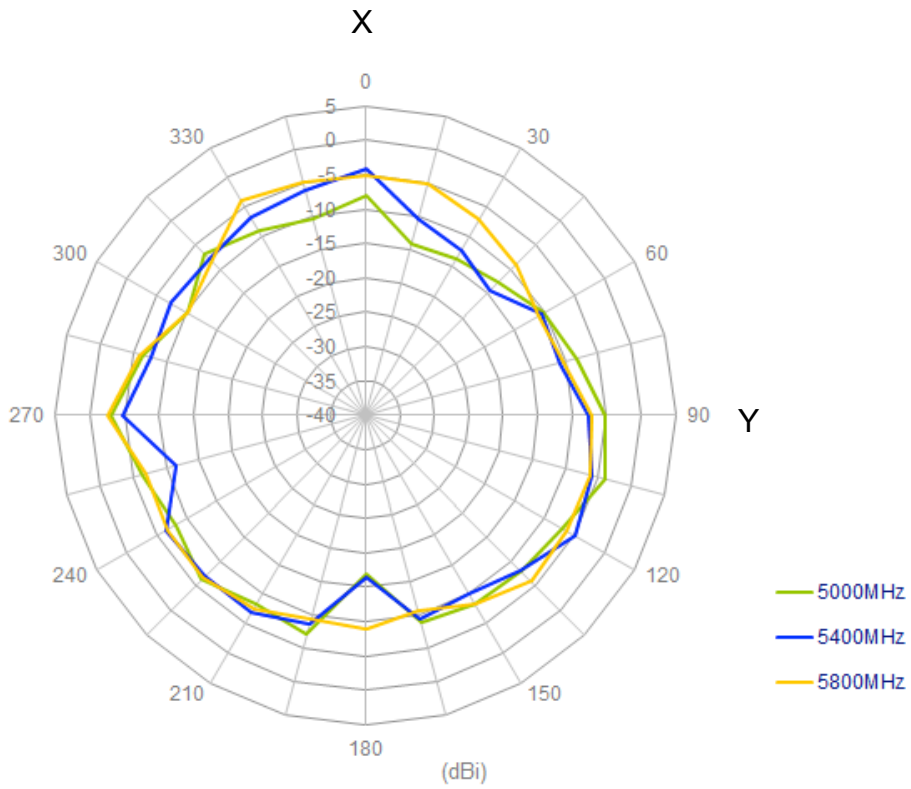

XZ plane

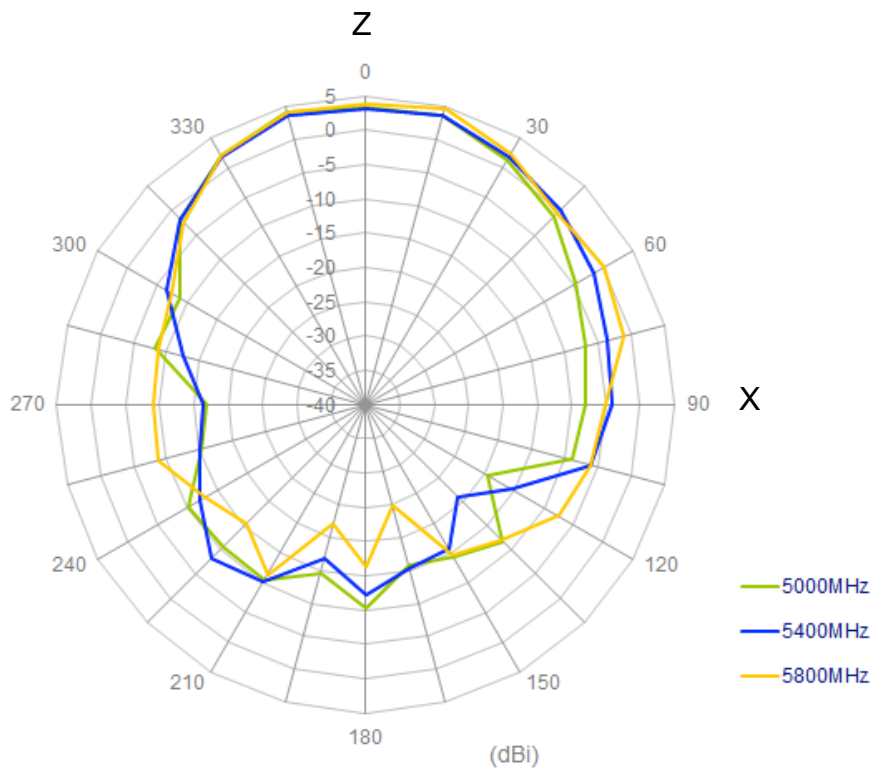

7.2 V-pol. 1 antenna

XY plane

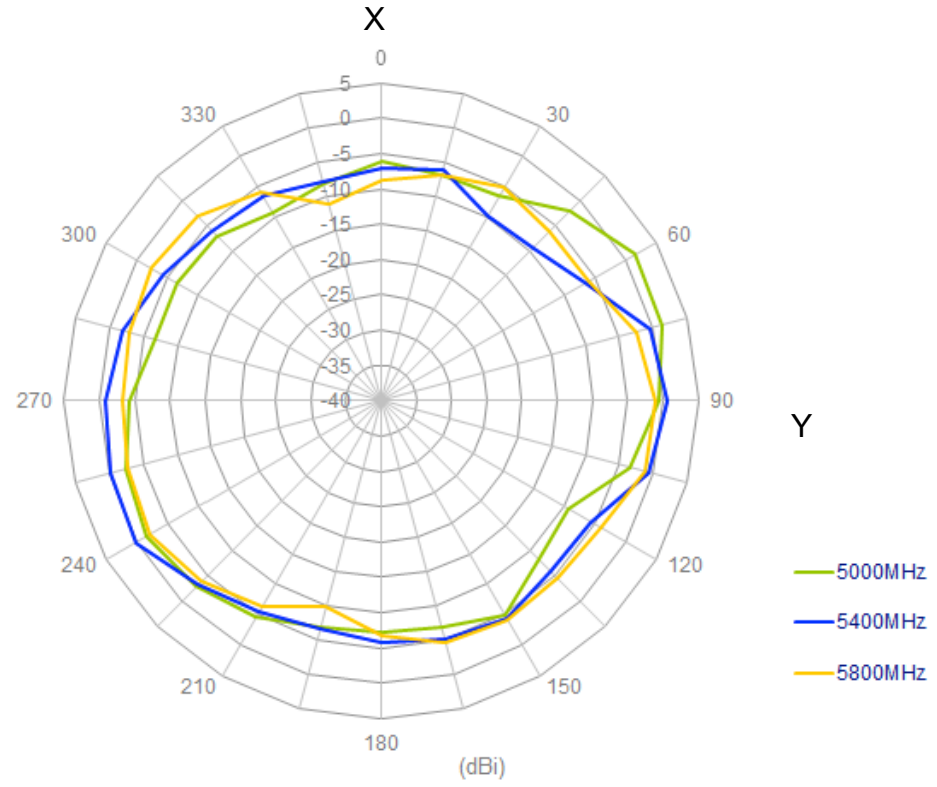

XZ plane

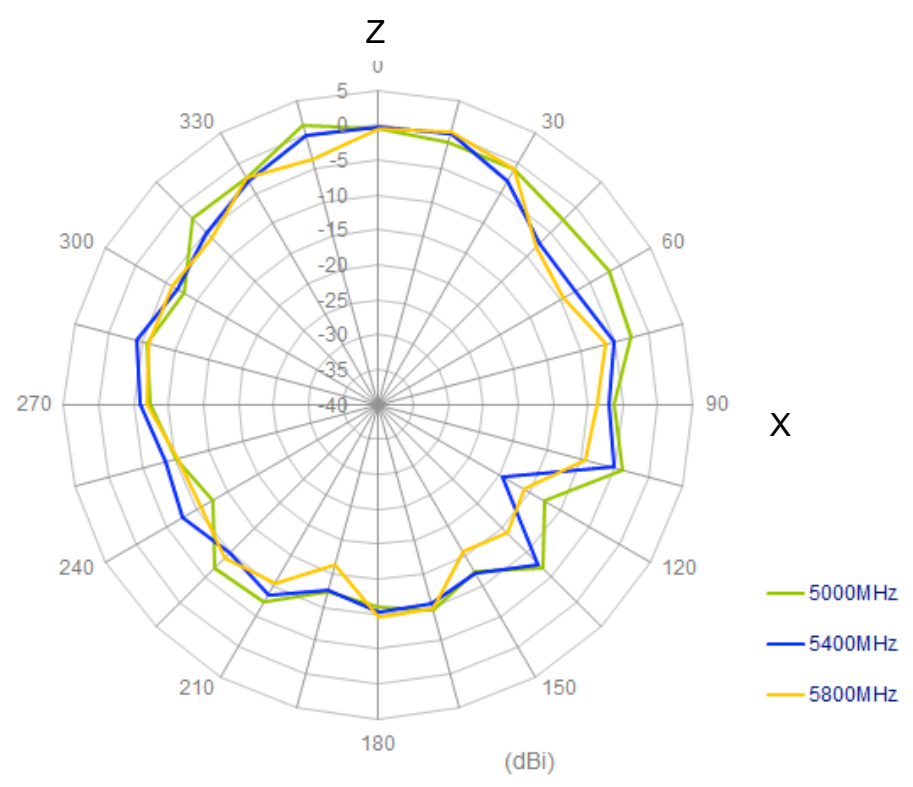

7.3 V-pol. 2 antenna

XY plane

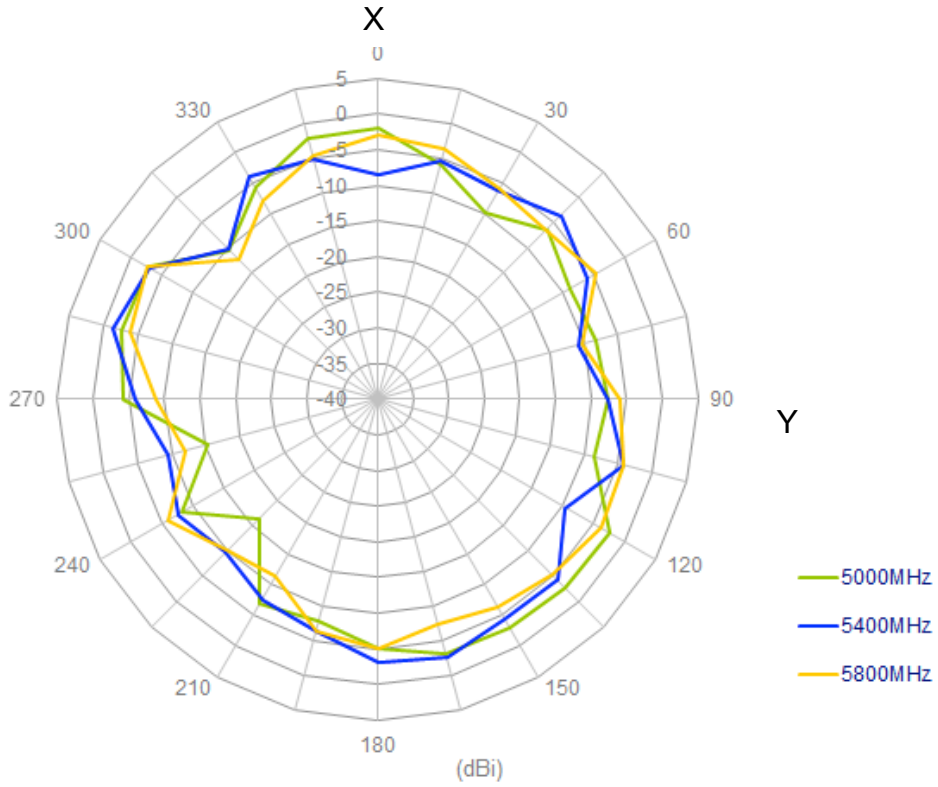

XZ plane

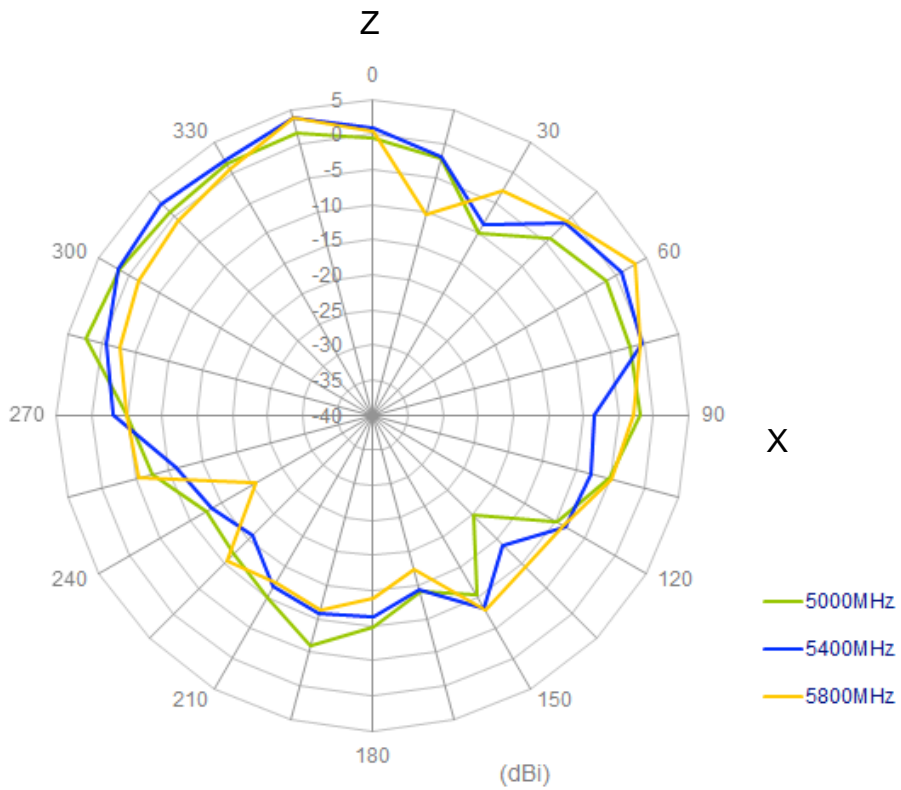

8. Cable attenuation

		Cable attenuation (dB/ 100M)											
GHz	0.5	1	1.5	2	2.5	3	3.5	4	4.5	5	5.5	6	
CFD 200	26	39	49	58	66	73	-	86	-	98	-	109	

9. Mechanical Drawing

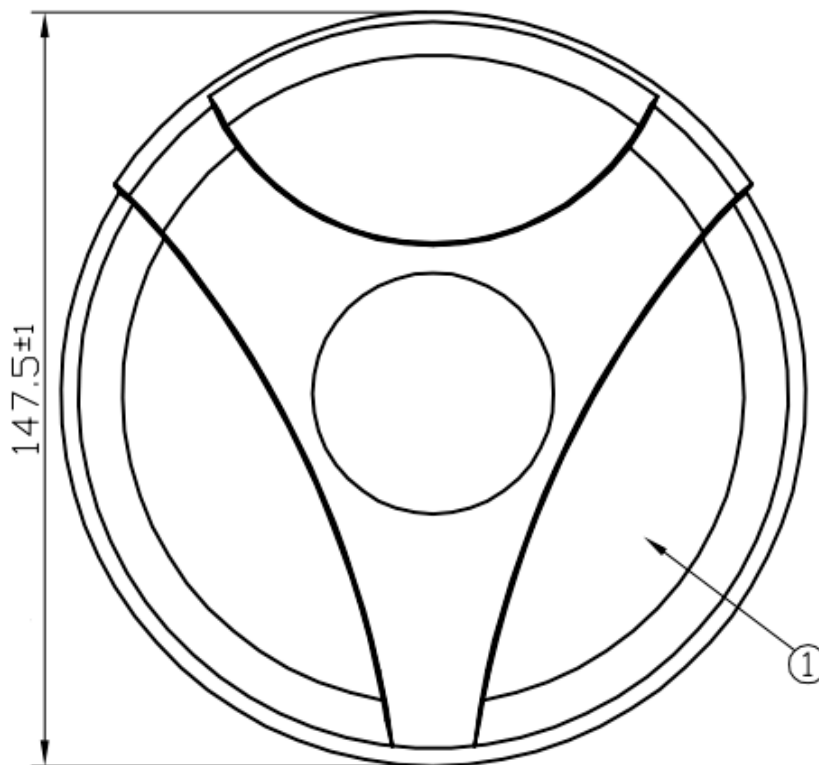

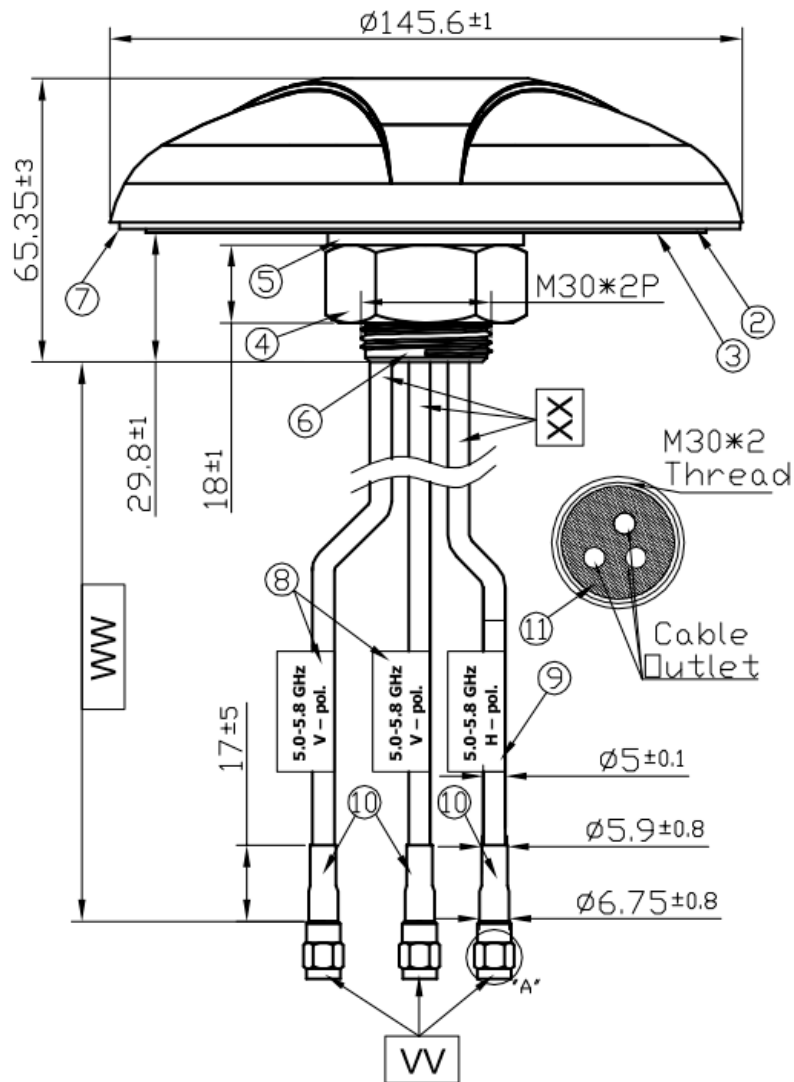

	Name	P/N	Material	Finish	QTY
1	Housing	000111F0000XXA	PC 540	Black	1
2	Closed Cell Foam	001011F0300XXA	CR 4305	Black	1
3	3M Double Adhesive	001011F0300XXA	3M 9448 HK	White Liner	1
4	M30 Nut	000411F0000XXA	Steel AISI 1215	Ni Plated	1
5	Washer	000411F0100XXA	Steel AISI 1215	Ni Plated	1
6	M30x 2 Thread 32L	000311F0000XXA	Zinc Alloy	Ni Plated	1
7	Waterproof Rubber	000711F0000XXA	Silicon	Black	1
8	5.0-5.8GHz V-pol.Label	001012A020015A	Matte Silver PET	Silver	2
9	5.0-5.8GHz H-pol.Label	001012A030015A	Matte Silver PET	Silver	1
10	Heat Shrink Tube	001311F0100XXA	PE	Black	3
11	Rubber Stopper	000711F0000XXA	Silicone Rubber	Black	1
	Name	P/N	Spec	Finish	QTY
VV	Connector Type	SMA,M.RP,ST,PLUG,G,WY	SMA(M)RP ST	Gold	3
WW	Cable Length		3000±30mm		
XX	Cable Type	301412A000015A	CFD 200	Black	3

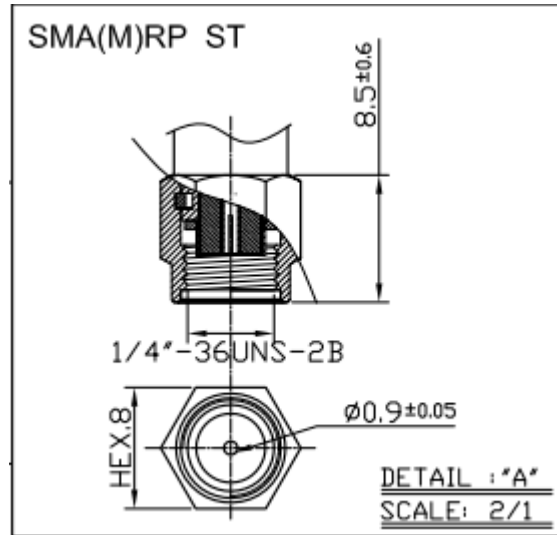

10. Packaging

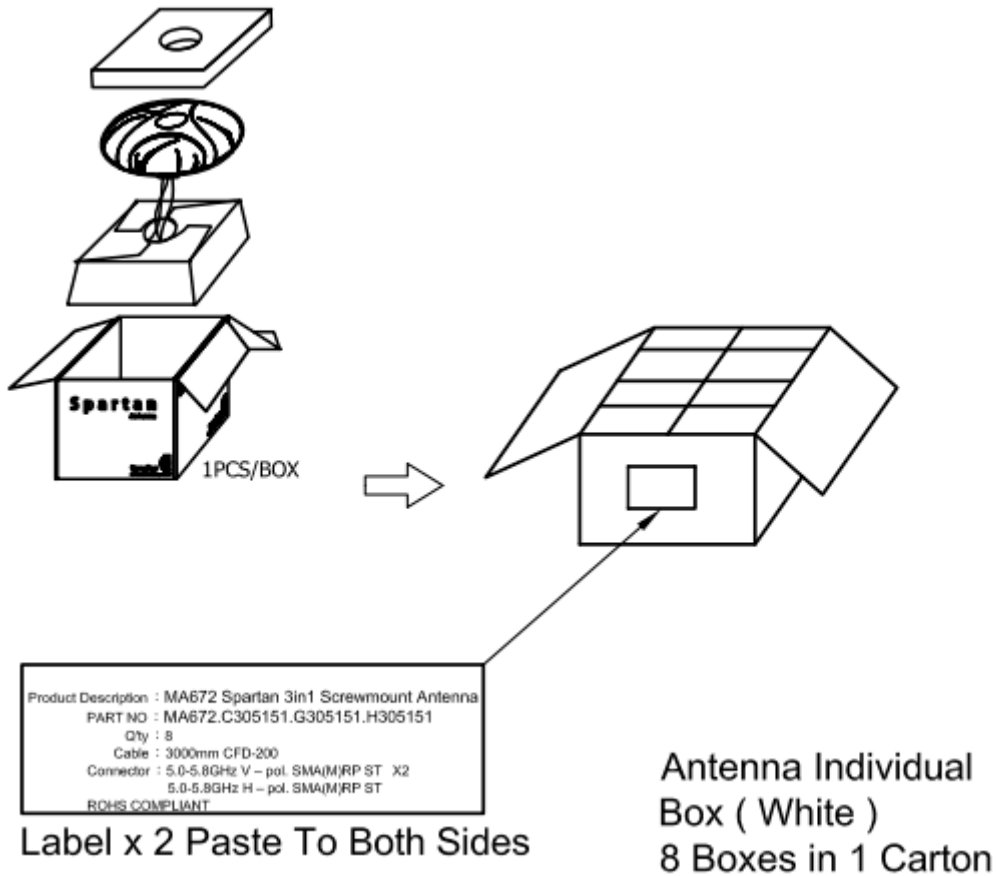

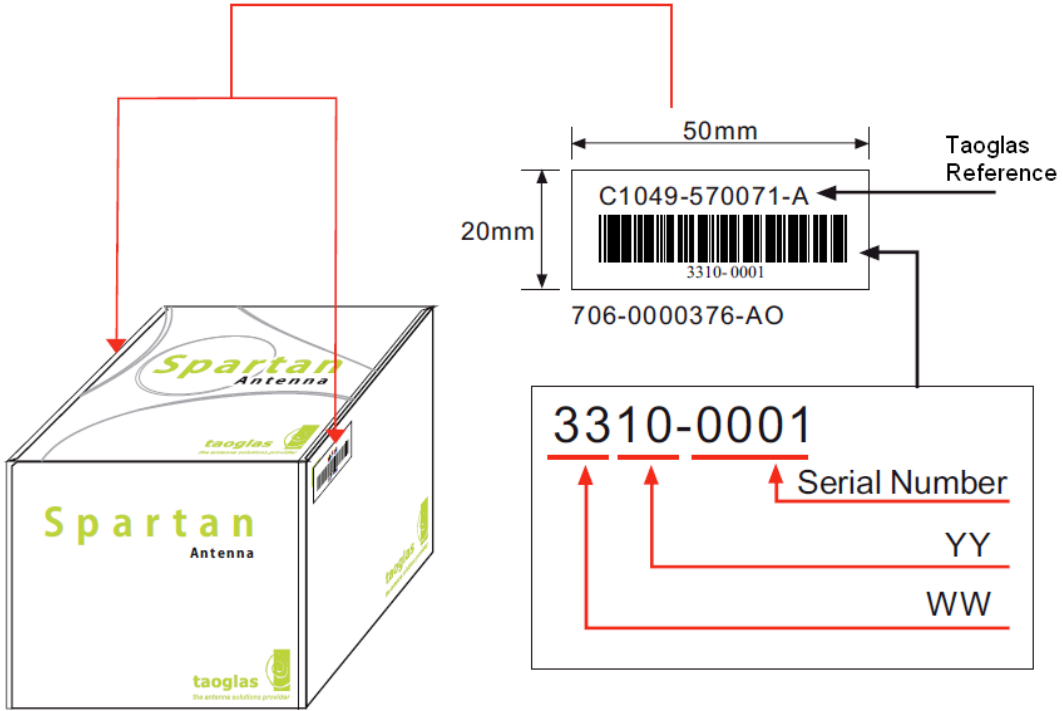

8 boxes per carton

