

CONTACT CONFIGURATION
TIMING (BBM) NON-SHORTING

ISOMETRIC

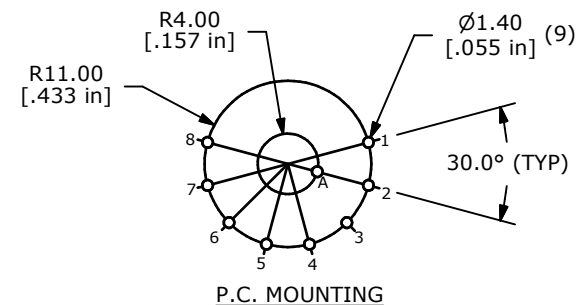
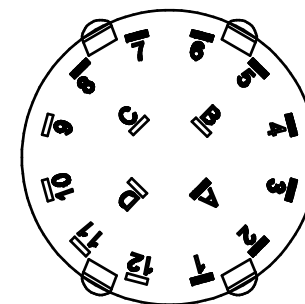
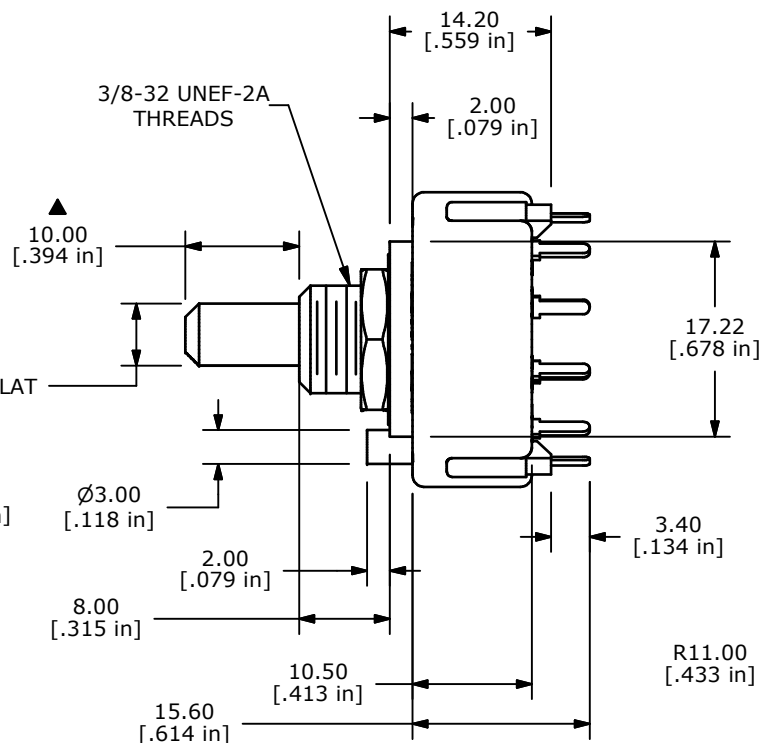
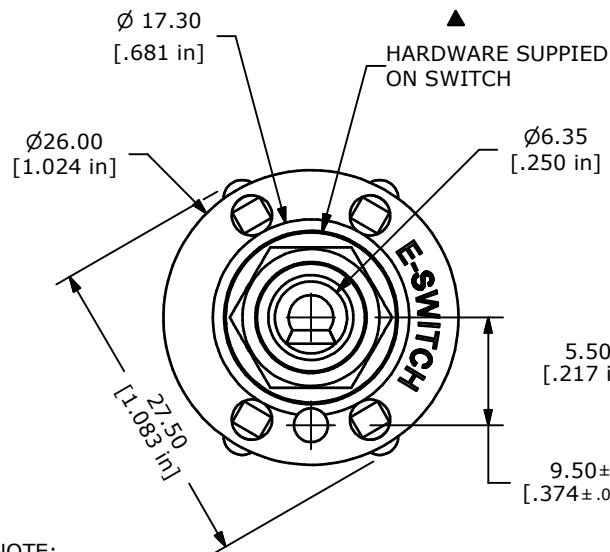
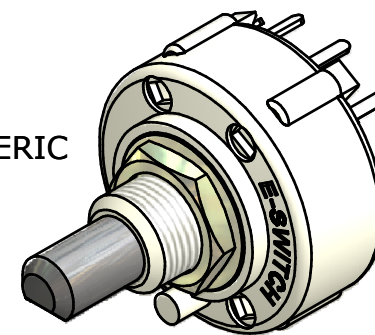

NOTE:

1. ALL DIMENSIONS IN MM[INCH].
2. GENERAL TOLERANCE: X.X=±0.4
X.XX=±0.25
3. TERM. NOS. FOR REFERENCE ONLY.
- ▲ 4. CONTACT MATERIAL: SILVER
5. CONTACT RATING: 350MILLIAMPS @ 125VAC
6. CONTACT RATING (NON-SWITCHING): 5A
7. CONTACT RESISTANCE: 50 Milli-OHMS max.
8. OPERATING FORCE: 800 ± 300 gm/cm
9. OPERATING TEMP: -30°C TO 85°C
- ▲ 10. CIRCUIT SP: 8 POSITION 30° INDEX.
11. INSULATION RESISTANCE: 100 Mega-OHMS min.
12. WITHSTAND VOLTAGE: 500VAC FOR 1 MINUTE.
- ▲ 13. HARDWARE SUPPLIED ON SWITCH: LOCKWASHER, HEXNUT, STOP RING
14. ▲ DENOTES CRITICAL PARAMETER.
15. 2002/95/EC (ROHS) COMPLIANT



TITLE KC18A10.001NPS

A	18686	RELEASED FOR PRODUCTION	10/19/09	BLR
REV	PCR NO	DESCRIPTION	DATE	BY

SCALE	DATE	DR	DWG	REV
1.5:1	10/19/2009	BLR	G530172	A

THE INFORMATION CONTAINED IN THIS DOCUMENT IS PROPRIETARY TO E-SWITCH AND IS NOT TO BE COPIED OR TRANSFERRED