

ASMB-784

**LGA 1150 Intel® Xeon® E3 v3/4th
Generation Core ATX Server Board
with 2 PCIe x16 slots (x8 link) or 1
PCIe x16 slot (x16 link), 3 PCI, USB
3.0, PCIe Gen III, Quad/Dual LANs**

Copyright

The documentation and the software included with this product are copyrighted 2017 by Advantech Co., Ltd. All rights are reserved. Advantech Co., Ltd. reserves the right to make improvements in the products described in this manual at any time without notice. No part of this manual may be reproduced, copied, translated or transmitted in any form or by any means without the prior written permission of Advantech Co., Ltd. Information provided in this manual is intended to be accurate and reliable. However, Advantech Co., Ltd. assumes no responsibility for its use, nor for any infringements of the rights of third parties, which may result from its use.

Acknowledgements

AMI is a trademark of American Megatrends Inc.

IBM and PC are trademarks of International Business Machines Corporation.

Intel® Xeon, Core i and Pentium® are trademarks of Intel® Corporation.

WinBond is a trademark of Winbond Corporation.

All other product names or trademarks are properties of their respective owners.

A Message to the Customer

Advantech Customer Services

Each and every Advantech product is built to the most exacting specifications to ensure reliable performance in the harsh and demanding conditions typical of industrial environments. Whether your new Advantech equipment is destined for the laboratory or the factory floor, you can be assured that your product will provide the reliability and ease of operation for which the name Advantech has come to be known.

Your satisfaction is our primary concern. Here is a guide to Advantech's customer services. To ensure you get the full benefit of our services, please follow the instructions below carefully.

Technical Support

We want you to get the maximum performance from your products. So if you run into technical difficulties, we are here to help. For the most frequently asked questions, you can easily find answers in your product documentation. These answers are normally a lot more detailed than the ones we can give over the phone.

So please consult this manual first. If you still cannot find the answer, gather all the information or questions that apply to your problem, and with the product close at hand, call your dealer. Our dealers are well trained and ready to give you the support you need to get the most from your Advantech products. In fact, most problems reported are minor and are easily solved over the phone.

In addition, free technical support is available from Advantech engineers every business day. We are always ready to give advice on application requirements or specific information on the installation and operation of any of our products.

Declaration of Conformity

FCC

This device complies with the requirements in part 15 of the FCC rules:

Operation is subject to the following two conditions:

- This device may not cause harmful interference
- This device must accept any interference received, including interference that may cause undesired operation.

This equipment has been tested and found to comply with the limits for a Class B digital device, pursuant to Part 15 of the FCC Rules. These limits are designed to provide reasonable protection against harmful interference when the equipment is operated in a commercial environment. This equipment generates, uses, and can radiate radio frequency energy and, if not installed and used in accordance with the instruction manual, may cause harmful interference to radio communications. Operation of this device in a residential area is likely to cause harmful interference in which case the user will be required to correct the interference at his/her own expense. The user is advised that any equipment changes or modifications not expressly approved by the party responsible for compliance would void the compliance to FCC regulations and therefore, the user's authority to operate the equipment.

Caution! *There is a danger of a new battery exploding if it is incorrectly installed. Do not attempt to recharge, force open, or heat the battery. Replace the battery only with the same or equivalent type recommended by the manufacturer. Discard used batteries according to the manufacturer's instructions.*



Memory Compatibility

Brand	Size	Speed	ECC	Vendor PN	Advantech PN
Transcend	1GB	1066	N	TS128MLK64V1U	96D3-1G1066NN-TR
Transcend	2GB	1066	N	TS256MLK64V1U	N/A
Apacer	1GB	1066	N	78.01GC3.420	N/A
Apacer	2GB	1066	N	78.A1GC3.421	96D3-2G1066NN-AP
Apacer	4GB	1066	N	78.B1GDJ.AF1	N/A
Transcend	1GB	1333	N	TS128MLK64V3U	96D3-1G1333NN-TR
Transcend	2GB	1333	N	TS256MLK64V3U	96D3-2G1333NN-TR4
Transcend	4GB	1333	N	TS512MLK64V3N	96D34G1333NN-TR
Apacer	1GB	1333	N	78.01GC6.AF0	96D3-1G1333NN-AP1
Apacer	2GB	1333	N	78.A1GDE.4200C	96D3-2G1333NN-AP2
Apacer	2GB	1333	N	78.A1GDE.AF00C	N/A
Apacer	4GB	1333	N	78.B1GDE.AF1	96D3-4G1333NN-AP
Apacer	8GB	1333	N	78.C1GEP.4210C	N/A
Kingston	2GB	1333	N	KVR1333D3S8N9/2G	N/A
Kingston	4GB	1333	N	KVR1333D3N9/4G	N/A
ATP	2GB	1600	N	XQ16A8N2GS-9-AV	N/A
ATP	2GB	1600	N	XQ16A8N2GM-9-AV	N/A
ATP	4GB	1600	N	XQ16B8N4GS-9-AV	N/A
ATP	8GB	1600	N	XQ16B8N8GS-9-AV	N/A
Apacer	8GB	1600	N	78.C1GET.ATF0CMicron	N/A
DSL	2GB	1600	N	D3US56081XH12AA	N/A
DSL	4GB	1600	N	D3US56082XH12AA	N/A
Transcend	2GB	1600	N	TS256MLK64V6N	N/A
Transcend	4GB	1600	N	TS512MLK64V6N	N/A
Transcend	4GB	1600	N	TS512MLK64V6N	N/A
Transcend	8GB	1600	N	TS1GLK64V6H	N/A
Apacer	2GB	1066	Y	78.A1GC5.423	N/A
Apacer	4GB	1066	Y	78.B1GDK.AF3	N/A
Apacer	1GB	1333	Y	78.01GC8.422	96D3-1G1333E-AP
Apacer	2GB	1333	Y	78.A1GC8.423	96D3-2G1333E-AP
Apacer	4GB	1333	Y	78.B1GDF.AF3	N/A
Transcend	8GB	1333	Y	TS1GLK72V3H	96D3-8G1333E-TR
ATP	2GB	1333	Y	AQ56M72E8BJH9S	N/A
ATP	4GB	1333	Y	AQ12M72E8BKH9S	96D3-4G1333E-AT
ATP	8GB	1333	Y	AQ24M72E8BLH9S	96D3-8G1333E-AT
Transcend	8GB	1600	Y	TS1GLK72V6H	N/A

* Above list is subject to change. Please contact your sales or FAE for peripheral list update.

ASMB-784 Ordering Information

Part Number	Chipset	Memory	LAN	IPMI
ASMB-784G2-00A1E	C226	DDR3 ECC UNB/Non-ECC	2	Optional Module (IPMI-1000)
ASMB-784G4-00A1E	C226	DDR3 ECC UNB/Non-ECC	4	Optional Module (IPMI-1000)

Product Warranty (2 years)

Advantech warrants to you, the original purchaser, that each of its products will be free from defects in materials and workmanship for two years from the date of purchase.

This warranty does not apply to any products which have been repaired or altered by persons other than repair personnel authorized by Advantech, or which have been subject to misuse, abuse, accident or improper installation. Advantech assumes no liability under the terms of this warranty as a consequence of such events.

Because of Advantech's high quality-control standards and rigorous testing, most of our customers never need to use our repair service. If an Advantech product is defective, it will be repaired or replaced at no charge during the warranty period. For out-of-warranty repairs, you will be billed according to the cost of replacement materials, service time and freight. Please consult your dealer for more details.

If you think you have a defective product, follow these steps:

1. Collect all the information about the problem encountered. (For example, CPU speed, Advantech products used, other hardware and software used, etc.) Note anything abnormal and list any onscreen messages you get when the problem occurs.
2. Call your dealer and describe the problem. Please have your manual, product, and any helpful information readily available.
3. If your product is diagnosed as defective, obtain an RMA (return merchandise authorization) number from your dealer. This allows us to process your return more quickly.
4. Carefully pack the defective product, a fully-completed Repair and Replacement Order Card and a photocopy proof of purchase date (such as your sales receipt) in a shippable container. A product returned without proof of the purchase date is not eligible for warranty service.
5. Write the RMA number visibly on the outside of the package and ship it prepaid to your dealer.

Initial Inspection

Before you begin installing your motherboard, please make sure that the following materials have been shipped:

- 1 ASMB-784 Startup Manual
- 1 Driver CD (user's manual is included)
- 2 Serial ATA HDD data cables
- 2 Serial ATA HDD power cables
- 1 I/O port bracket
- 1 Warranty card

If any of these items are missing or damaged, contact your distributor or sales representative immediately. We have carefully inspected the ASMB-784 mechanically and electrically before shipment. It should be free of marks and scratches and in perfect working order upon receipt. As you unpack the ASMB-784, check it for signs of shipping damage. (For example, damaged box, scratches, dents, etc.) If it is damaged or it fails to meet the specifications, notify our service department or your local sales representative immediately. Also notify the carrier. Retain the shipping carton and packing material for inspection by the carrier. After inspection, we will make arrangements to repair or replace the unit.

Contents

Chapter 1 Hardware Configuration.....1

1.1	Introduction	2
1.2	Features	2
1.3	Specifications	3
1.3.1	System	3
1.3.2	Memory	3
1.3.3	Input/Output	3
1.3.4	Graphics.....	3
1.3.5	Ethernet LAN	3
1.3.6	Industrial Features	4
1.3.7	Mechanical and Environmental Specifications.....	4
1.4	Jumpers and Connectors	4
	Table 1.1: Jumper list	4
	Table 1.2: Connector list.....	5
1.5	Board Layout: Jumper and Connector Locations.....	6
	Figure 1.1 Jumper and Connector Locations.....	6
	Figure 1.2 I/O connectors	6
1.6	ASMB-784 Block Diagram	7
	Figure 1.3 ASMB-784 Block Diagram.....	7
1.7	Safety Precautions	7
1.8	Jumper Settings	8
1.8.1	How to set jumpers	8
	Table 1.3: JCMOS1	8
	Table 1.4: JME1	8
	Table 1.5: Watchdog timer output (JWDT1).....	9
	Table 1.6: USB power switch (JUSB1, JUSB2).....	9
	Table 1.7: (CPUFAN_SEL1, SYSFAN_SEL1)	10
	Table 1.8: ATX/AT mode selector (PSON1).....	10
	Table 1.9: Chassis intrusion switch type (JCASE1)	10
1.9	System Memory	10
1.10	Memory Installation Procedures.....	11
1.11	Cache Memory.....	11
1.12	Processor Installation.....	11
1.13	PCI Bus Routing Table.....	11

Chapter 2 Connecting Peripherals13

2.1	Introduction	14
2.2	Parallel Port (LPT1).....	14
2.3	USB Ports (LAN1_USB4_5,LAN2_USB0_1,USB2_3, USB6_7, USB8_9,USB10_11, USB12).....	15
2.4	USB Power Switch	16
2.5	VGA Connector (VGA1).....	17
2.6	Serial Ports (COM1, COM2)	17
2.7	PS/2 Keyboard and Mouse Connector (KBMS1) and External Keyboard & Mouse (KBMS2).....	18
2.8	CPU Fan Connector (CPUFAN0).....	18
2.9	System FAN Connector (SYSFAN0, SYSFAN1, SYSFAN2 and SYSFAN3)	19
2.10	Front Panel Connectors (JFP1~3)	19
2.10.1	Power LED (JFP3).....	20
	Table 2.1: PS/2 or ATX power supply LED status.....	20
2.10.2	External Speaker (JFP2 pins 1, 4, 7, 10).....	20
2.10.3	HDD LED Connector (JFP1 pins 2 & 5).....	20

2.10.4	ATX Soft Power Switch (JFP1 pins 3 & 6).....	20
2.10.5	Reset Connector (JFP1 pins 9 & 12).....	20
2.10.6	SNMP SMBus Connector (JFP2 pins 8 & 11).....	20
2.11	8-pin Alarm Board Connector (VOLT1).....	21
2.12	Case Open Connector (JCASE1).....	21
2.13	Front Panel LAN Indicator Connector (LANLED1).....	22
	Table 2.2: Front Panel LAN Indicator Connector	22
2.14	Serial ATA Interface (SATA0~5).....	22
2.15	PCI Slots (PCI_SLOT1, PCI_SLOT3, PCI_SLOT5).....	23
2.16	PCIe x16 Expansion Slots (PCIEX16_SLOT4 and PCIEX16_SLOT6)...	23
2.17	PCIe x1 Expansion Slots (PCIEX1_SLOT2, PCIEX1_SLOT7).....	24
2.18	Auxiliary 8-pin Power Connector (ATX12V1).....	24
2.19	SPI Flash Connector(SPI_CN1).....	25
2.20	Low Pin Count Connector (LPC1).....	25
	Table 2.3: Advantech LPC Module List.....	25
2.21	PCI Clock Selection (JPCICLK1).....	26
2.22	KBMS Power Selection (JKBMS1).....	26

Chapter 3 BIOS Operation 27

3.1	Introduction.....	28
	Figure 3.1 Main setup screen.....	28
3.2	Entering BIOS Setup.....	28
3.2.1	Main Menu.....	29
	Figure 3.2 Main setup screen.....	29
3.2.2	System time / System date.....	29
3.3	Advanced BIOS Features Setup.....	30
	Figure 3.3 Advanced BIOS features setup screen.....	30
3.3.1	PCI Subsystem Settings.....	31
	Figure 3.4 PCI subsystem settings screen.....	31
	Figure 3.5 PCI Express Setting.....	31
3.3.2	ACPI Settings.....	33
	Figure 3.6 ACPI Settings.....	33
3.3.3	Trusted Computing.....	34
	Figure 3.7 TPM Settings.....	34
3.3.4	CPU Configuration.....	35
	Figure 3.8 CPU Configuration.....	35
3.3.5	SATA Configuration.....	37
	Figure 3.9 SATA Configuration.....	37
3.3.6	PCH-FW Configuration.....	38
	Figure 3.10 Intel ME FW Configuration Information.....	38
3.3.7	AMT Configuration.....	39
	Figure 3.11 AMT Configuration.....	39
3.3.8	USB Configuration.....	40
	Figure 3.12 USB Configuration.....	40
3.3.9	SMART Settings.....	41
	Figure 3.13 SMART Setting.....	41
3.3.10	Super IO Configuration.....	42
	Figure 3.14 Super IO Configuration.....	42
	Figure 3.15 Serial Port 1 Configuration.....	42
	Figure 3.16 Serial Port 2 Configuration.....	43
	Figure 3.17 Parallel Configuration.....	43
3.3.11	H/W Monitor.....	44
	Figure 3.18 PC Health Status.....	44
3.3.12	Serial Port Console Redirection.....	45
	Figure 3.19 Serial Port Console Redirection.....	45
	Figure 3.20 Console Redirection Setting.....	46
3.4	Chipset.....	48
	Figure 3.21 Chipset.....	48

3.4.1	PCH-IO Configuration	48
	Figure 3.22PCH-IO Configuration.....	48
	Figure 3.23PCI Express Configuration	49
	Figure 3.24PCI Express Slot 2 Configuration	50
	Figure 3.25PCI Express Slot 7 Configuration	51
	Figure 3.26USB Configuration.....	52
	Figure 3.27PCH Azalia	53
	Figure 3.28LAN Configuration	53
3.4.2	System Agent (SA) Configuration	54
	Figure 3.29System Agent (SA) Configuration.....	54
	Figure 3.30Graphics Configuration.....	55
	Figure 3.31NB PCIe Configuration	56
	Figure 3.32Memory Configuration	57
3.5	Boot.....	58
	Figure 3.33Boot	58
	Figure 3.34CSM16 Parameters	59
3.6	Security	60
	Figure 3.35Security.....	60
3.7	Save & Exit.....	61
	Figure 3.36Save & Exit.....	61
3.8	Server Management.....	62
	Figure 3.37Server Management	62
3.8.1	BMC Self Test Log.....	63
	Figure 3.38BMC Self Test Log	63
3.8.2	System Event Log.....	64
	Figure 3.39System Event Log	64
3.8.3	BMC Network Configuration	65
	Figure 3.40BMC network configuration	65

Chapter 4 Chipset Software Installation Utility 67

4.1	Before You Begin	68
4.2	Introduction	68
4.3	Windows OS Driver Setup	69

Chapter 5 VGA Setup.....71

5.1	Introduction	72
5.2	Windows OS Driver Setup	72

Chapter 6 LAN Configuration.....73

6.1	Introduction	74
6.2	Features	74
6.3	Installation	74
6.4	Windows OS Driver Setup (LAN).....	74

Chapter 7 Intel ME.....75

7.1	Introduction	76
7.2	Installation.....	76

Chapter 8 Intel USB 3.0.....77

8.1	Introduction	78
8.2	Installation.....	78

Chapter	9	SATA RAID Setup	79
	9.1	Introduction	80
	9.2	SATA RAID Driver and Utility Setup	80
Appendix A		Programming the Watchdog Timer .	81
	A.1	Watchdog timer overview.....	82
	A.2	Programming the Watchdog Timer	82
		Table A.1: Watchdog timer registers	84
	A.2.1	Example Programs	84
Appendix B		I/O Pin Assignments	89
	B.1	Parallel Port (LPT1)	90
		Table B.1: Parallel Port (LPT1).....	90
	B.2	USB2.0 Header (USB6~11).....	90
		Table B.2: USB Header (USB6~11)	90
	B.3	USB3.0 Header (USB2_3).....	91
		Table B.3: USB 3.0 Header (USB2_3)	91
	B.4	VGA Connector (VGA).....	91
		Table B.4: VGA Connector (VGA)	91
	B.5	RS-232 Interface (COM2).....	92
		Table B.5: RS-232 Interface (COM2)	92
	B.6	External Keyboard and Mouse Connector (KBMS2)	92
		Table B.6: External Keyboard and Mouse Connector (KBMS2)	92
	B.7	System Fan Power Connector (SYSFAN0~3)	93
		Table B.7: Fan Power Connector	93
	B.8	Power LED and Keyboard Lock (JFP3).....	93
		Table B.8: Power LED and Keyboard Lock (JFP3)	93
	B.9	External Speaker Connector (JFP2).....	93
		Table B.9: External Speaker Connector (JFP2)	93
	B.10	Reset Connector (JFP1)	94
		Table B.10:Reset Connector (JFP1).....	94
	B.11	HDD LED Connector (JFP2).....	94
		Table B.11:HDD LED Connector (JFP2)	94
	B.12	ATX Soft Power Switch (JFP1).....	94
		Table B.12:ATX Soft Power Switch (JFP1)	94
	B.13	USB/LAN ports (LAN1_USB01 and LAN2_USB23)	95
		Table B.13:USB Port	95
		Table B.14:Giga LAN 10/100/1000 Mbps RJ-45 port	95
	B.14	Front Panel Audio Connector (FPAUD1).....	95
		Table B.15:Front Panel Audio Connector (FPAUD1)	95
	B.15	8-pin Alarm Board Connector (VOLT1).....	96
		Table B.16:8-pin Alarm Board Connector (VOLT1).....	96
	B.16	Case Open Connector (JCASE1).....	96
		Table B.17:Case Open Connector (JFP1).....	96
	B.17	Front Panel LAN LED Connector (LAN_LED1/2)	96
		Table B.18:LAN LED Connector (LAN_LED1/2)	96
	B.18	SPI_CN1: SPI flash card pin connector	97
		Table B.19:SPI_CN1:SPI fresh card pin connector	97
	B.19	SMBUS1: Connector of SMBUS from PCH	97
		Table B.20:SMBUS Connector	97
	B.20	System I/O Ports.....	97
		Table B.21:System I/O ports.....	97
	B.21	Interrupt Assignments	98
		Table B.22:Interrupt assignments.....	98
	B.22	1st MB Memory Map.....	98

Table B.23:1st MB memory map 98

Chapter 1

Hardware
Configuration

1.1 Introduction

ASMB-784 motherboard is designed with the most advanced Intel® C226 PCH for industrial server grade applications that require high-performance computing. The motherboard supports Intel® Xeon® E3 v3/4th Generation Core processor with DDR3 ECC 1066/1333/1600MHz memory for up to 32 GB. ASMB-784 also provides cost-effective Intel HD graphics integrated on processor, and the graphics VRAM is 1 GB maximum shared memory with 2 GB and above system memory installed. To fulfill a variety of demands for PCIe interface cards for video surveillance and factory automation markets, ASMB-784 offers a maximum of up to four PCIe slots, including one PCIe x16 slot with x16 link or switchable to two PCIe x16 slots with x8 link (Gen III) from CPU, and two PCIe x1 slot (Gen II) from PCH. In addition, ASMB-784 also comes with three PCI slots via a discrete PCIe to PCI bridge chip to support legacy PCI expansion cards and has four or two Gigabit Ethernet LAN via dedicated PCIe bus, which offers bandwidth up to 300 MB/s eliminating network bottlenecks.

By using the Intel® C226 chipset, the ASMB-784 offers a variety of features such as six onboard SATA III interfaces (bandwidth = 600 MB/s) with software RAID; 4 x USB 3.0 and 10 x USB 2.0 connectors plus 4 x USB 3.0. These powerful I/O capabilities and outstanding performance on ASMB-784 ensures even more reliable data storage capabilities and high-speed I/O peripheral connectivity.

The ASMB-784 also adopts Advantech's unique, patented Sleep Mode Control Circuit for AT Power Mode. With all the excellent features and outstanding performance, ASMB-784 is the ideal platform for today's industrial applications.

1.2 Features

- **Triple Display:** ASMB-784 has one VGA and two DVI-D ports, and users are able to connect all three display ports simultaneously for triple display purpose.
- **PCIe architecture:** ASMB-784 supports one PCIe x16 with Gen III x16 link or two PCIe x16 slots with Gen III x8 link from Intel CPU, and two x1 slots from Intel C226 PCH.
- **High Performance I/O capability:** 4 or 2 x Gigabit LAN via PCIe bus, 3 x PCI 32-bit/33 or 66 MHz PCI slots, 4 x USB 3.0, 9 x USB 2.0 ports. (1*Type A USB 2.0), 6 x SATA III connectors.
- **Standard ATX form factor with industrial features:** ASMB-784 provides industrial features like long product life, reliable operation under wide temperature range, watchdog timer functions, etc.
- **Automatic power on after power failure:** It is often necessary to have an unattended system come back into operation when power resumes after a power failure. Advantech's industrial motherboard allows users to set the system to power on automatically without hitting the power button. Please refer to the detailed "AT" mode settings in Table 1.8 of Section 1.8.1.5.
- **Active Management Technology 9.0:** The hardware and firmware base solution is powered by the system auxiliary power plane to remotely monitor networked systems. Intel AMT (iAMT) stores hardware and software information in non-volatile memory. Built-in management provides out-of-band management capabilities, allowing remote discovery and KVM to repair systems after OS failures or when a system has crashed. Alert and event logging features detect problems and quickly reduce downtime, pro-actively blocking incoming threats, containing infected clients before they impact the network, and proactively notifying the user when critical software agents are removed. To enable iAMT, please refer 3.3.7 AMT Configuration.

1.3 Specifications

1.3.1 System

- **SATA hard disk drive interface:** Six on-board SATA III connectors support Advanced Host Controller Interface (AHCI) technology and have data transmission rates up to 600 MB/s.
- **System Chipset:** Intel® C226

1.3.2 Memory

- **RAM:** Up to 32 GB in four 240-pin DIMM sockets. Supports dual-channel DDR3 ECC/Non-ECC 1066/1333/1600 SDRAM.

Note! 1. Due to the inherent limitations of PC architecture, the system may not fully detect 32 GB RAM when 32 GB RAM is installed.



2. A 32-bit OS may not fully detect 4 GB of RAM when 4 GB is installed.

1.3.3 Input/Output

- **PCIe slot:** 1 PCIe x16 expansion slot with x16 link (Gen III) or switchable to 2 PCIe x16 expansion slots with x8 link (Gen III) slots (x8 link), and 2 PCIe x1 expansion slots
- **PCI Bus:** 3 PCI slot, 32-bit, 33 or 66 MHz PCI 2.2 compliant, and clock could be selected by jumper (JPCICLK1).
- **Enhanced parallel port:** Configured to LPT1 or disabled. Standard DB-25 female connector cable is an optional accessory. LPT1 supports EPP/SPP/ECP.
- **Serial port:** Two serial ports. (COM1 is rear IO, COM2 is on board connector)
- **PS/2 Keyboard and mouse connector:** Two 6-pin mini-DIN connectors are located on the mounting bracket for easy connection to PS/2 keyboard and mouse.
- **USB port:** Supports up to 4 USB 3.0 ports with transmission up to 5Gbps and 9 USB 2.0 ports with transmission rates up to 480 Mbps.
- **LPC:** One LPC connector to support Advantech TPM LPC modules.
- **GPIO:** ASMB-784 supports 8-bit GPIO from super I/O for general purpose control application.

1.3.4 Graphics

- Processor is integrated Intel HD Graphics.
- **Display memory:** 1 GB maximum shared memory with 2 GB and above system memory installed
- **DVI-D:** Two DVI-D ports, and up to resolution 1920 x 1200 @ 60 Hz refresh rate
- **CRT:** Up to 1920 x 1200 resolution @ 60 Hz refresh rate

1.3.5 Ethernet LAN

- Supports dual/quad 10/100/1000 Mbps Ethernet port (s) via PCIe bus which provides a 300 MB/s data transmission rate.
- **Interface:** 10/100/1000 Mbps
- **Controller:** LAN1: Intel I217-LM; LAN2/3/4: Intel I210-AT (LAN3/4 is for G4 SKU only).

1.3.6 Industrial Features

- **Watchdog timer:** It can generate system reset or NC. The watchdog timer is programmable, with each unit equal to one second (255 levels).

1.3.7 Mechanical and Environmental Specifications

- **Operating temperature:** 0 ~ 60° C (32 ~ 140° F, Depending on CPU)
- **Storage temperature:** -40 ~ 85° C (-40 ~ 185° F)
- **Humidity:** 5 ~ 95% non-condensing
- **Power supply voltage:** +3.3 V, +5 V, ±12 V, 5 VSB
- **Power consumption:**
Max. load: +3.3 V @ 1.17 A, +5 V @ 2.30 A, +12 V @ 0.06 A, +12 V (8P) @ 4.33 A, +5 Vsb @ 0.16 A, -12 V @ 0.01 A
- **Board size:** 304.8 x 244 mm (12" x 9.6")
- **Board weight:** 0.8 kg (weight of board)

1.4 Jumpers and Connectors

Connectors on the ASMB-784 motherboard link it to external devices such as hard disk drives and a keyboard. In addition, the board has a number of jumpers that are used to configure your system for your application.

The tables below list the function of each of the jumpers and connectors. Later sections in this chapter give instructions on setting jumpers. Chapter 2 gives instructions for connecting external devices to your motherboard.

Table 1.1: Jumper list

Label	Function
JCMOS1	CMOS clear
JME1	Intel ME Disable Jumper for ME/BIOS update
JWDT1	Watch Dog Reset
JUSB1	USB0_1 and USB4_5 power source switch between +5 VSB and +5 V
JUSB2	USB2_3, USB6_7, USB8_9, USB10_11, USB12 power source switch between +5 VSB and +5 V
CPUFAN_SEL1 SYSFAN_SEL1	FAN PWM / DC mode selection
PSON1	AT(1-2) / ATX(2-3)
JCASE1	Case Open
JPEG1, JPEG2	PCIEX16_SLOT6 PCIe Link switch between one x16 or two x8 or x8, two x4
JKBMS1	PS/2 keyboard and mouse power source switch between +5 VSB and +5 V
JPCCLK1	PCI slot clock selection between 33 and 66 MHz

Table 1.2: Connector list

Label	Function
ATXPWR1	ATX 24 Pin main power connector (for System)
ATX12V1	Processor power connector (for CPU)
SATA0~5	SATA III (6Gb/s)
USB2_3	USB 3.0 Port 2 3 (Header)
USB6_7, USB8_9, USB10_11	USB 2.0 Port 6~11 (Header)
USB12	USB 2.0 Port 12 (USB Type A)
PCI_SLOT1, PCI_SLOT3, PCI_SLOT5	PCI slot
PCIEX16_SLOT4, PCIEX16_SLOT6	PCIe x16 slots (one x16 link for slot 6 or two x8 link)
PCIEX1_SLOT2, PCIEX1_SLOT7	PCIe x1 slot
DIMMA0,DIMMA1, DIMMB0,DIMMB1	DDR3 slot
CPUFAN0	CPU FAN connector
SYSFAN0,SYSFAN1, SYSFAN2,SYSFAN3	System FAN connector
LAN1_USB4_5,LAN2_USB0_1	LAN1 / USB 2.0 port 4, 5 stack connector LAN2 / USB 3.0 port 0, 1 stack connector
VGA_COM1	VGA+COM connector
DVI1+DVI2	DVI-D connector
KBMS2	External keyboard and mouse connector(6 pin)
SPI_CN1	SPI flash card pin header
SMBUS1	SM Bus From PCH
GPIO1	GPIO header
FPAUD1	Audio front panel header
LPT1	Parallel port
COM2	Serial port: RS-232
JFP1~3	Front panel header
LPC1	Low pin count connector for Advantech TPM LPC modules
LANLED1, LANLED2	LED extension connector
VOLT1	Voltage Display
PMBUS1	PMBUS connector to communicate with power supply
SGPIO1	Serial General Purpose I/O
SPDIF_OUT1	SPDIF Audio output pin header
BMC1	BMC connector to support IPMI-1000 module

1.5 Board Layout: Jumper and Connector Locations

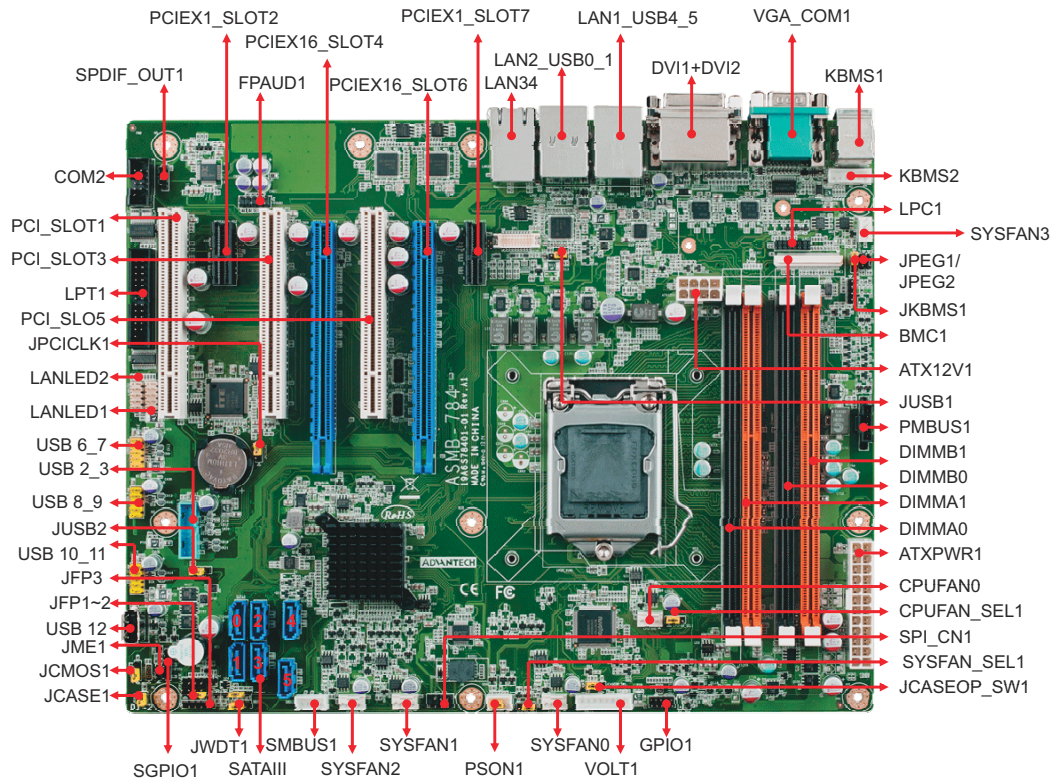
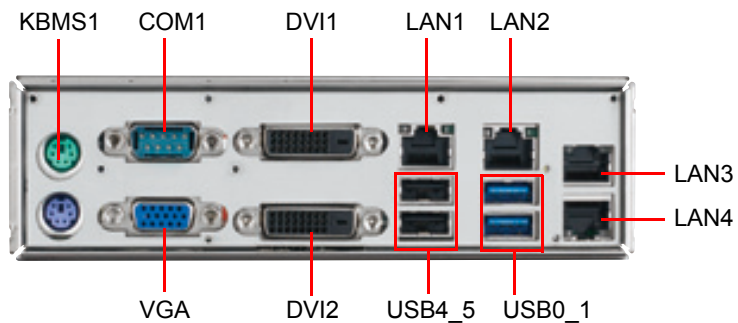

Figure 1.1 Jumper and Connector Locations



ASMB-784G2-00A1E



ASMB-784G4-00A1E

Figure 1.2 I/O connectors

1.6 ASMB-784 Block Diagram

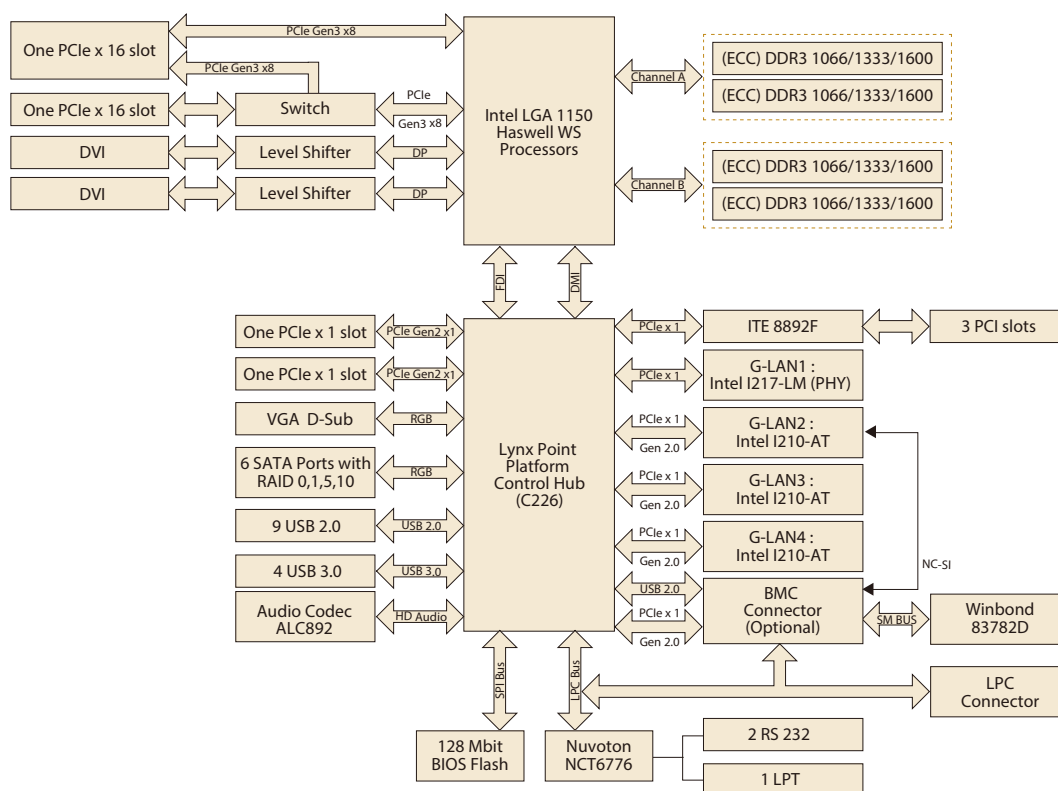

Figure 1.3 ASMB-784 Block Diagram

1.7 Safety Precautions

Warning! Always completely disconnect the power cord from your chassis whenever you work with the hardware. Do not make connections while the power is on. Sensitive electronic components can be damaged by sudden power surges. Only experienced electronics personnel should open the PC chassis.



Caution! Always ground yourself to remove any static charge before touching the motherboard. Modern electronic devices are very sensitive to static electric discharges. As a safety precaution, use a grounding wrist strap at all times. Place all electronic components on a static-dissipative surface or in a static-shielded bag when they are not in the chassis.



Caution! The computer is provided with a battery-powered real-time clock circuit. There is a danger of explosion if battery is incorrectly replaced. Replace only with same or equivalent type recommended by the manufacturer. Discard used batteries according to manufacturer's instructions.



Caution! There is a danger of a new battery exploding if it is incorrectly installed. Do not attempt to recharge, force open, or heat the battery. Replace the battery only with the same or equivalent type recommended by the manufacturer. Discard used batteries according to the manufacturer's instructions.



1.8 Jumper Settings

This section provides instructions on how to configure your motherboard by setting the jumpers. It also includes the motherboard default settings and your options for each jumper.

1.8.1 How to set jumpers

You can configure your motherboard to match the needs of your application by setting the jumpers. A jumper is a metal bridge that closes an electrical circuit. It consists of two metal pins and a small metal clip (often protected by a plastic cover) that slides over the pins to connect them. To “close” (or turn on) a jumper, you connect the pins with the clip. To “open” (or turn off) a jumper, you remove the clip. Sometimes a jumper consists of a set of three pins, labeled 1, 2, and 3. In this case you connect either pins 1 and 2, or 2 and 3. A pair of needle-nose pliers may be useful when setting jumpers.

1.8.1.1 CMOS and ME clear (JCMOS1)

The ASMB-784 motherboard contains a jumper that can erase CMOS data and reset the system BIOS information. Normally this jumper should be set with pins 1-2 closed. If you want to reset the CMOS data, set JCMOS1 to 2-3 closed for just a few seconds, and then move the jumper back to 1-2 closed. This procedure will reset the CMOS to its default setting.

Table 1.3: JCMOS1

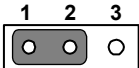
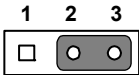
Function	Jumper Setting
* Keep CMOS data	 1-2 closed
Clear CMOS data	 2-3 closed
* default setting	

1.8.1.2 ME update (JME1)

The ASMB-784 contains a jumper that can update ME firmware. Normally this jumper should be set with pin 1-2 closed. If you want to update ME firmware, set JME1 to 2-3 closed to disable ME for new ME firmware update.

Table 1.4: JME1

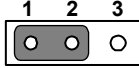
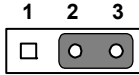
Function	Jumper Setting
*Lock ME update	 1-2 closed
ME update	 2-3 closed

1.8.1.3 Watchdog timer output (JWDT1)

The ASMB-784 contains a watchdog timer that will reset the CPU. This feature means the ASMB-784 will recover from a software failure or an EMI problem. The JWDT1 jumper settings control the outcome of what the computer will do in the event the watchdog timer is tripped.

Table 1.5: Watchdog timer output (JWDT1)

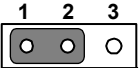
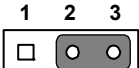
Function	Jumper Setting
*Reset	 1-2 closed
NC	 2-3 closed
* default setting	

Note! *The interrupt output of the watchdog timer is a low level signal. It will be held low until the watchdog timer is reset.*



1.8.1.4 USB power switch (JUSB1, JUSB2)

The ASMB-784 contains a jumper that can support on board USB ports power source from +5Vsb or +5V. The default setting is 1-2 closed which supports USB stand-by power under S5. When the jumper is 2-3 closed, the on board USB ports power source will be switched to +5V if you want to disable USB stand-by power under S5, and under 2-3 closed, it won't support S3 and S4 modes.

Table 1.6: USB power switch (JUSB1, JUSB2)

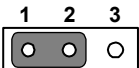
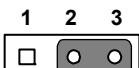
Function	Jumper Setting
*+5Vsb	 1-2 closed
+5V	 2-3 closed

1.8.1.5 CPU,SYSTEM fan PWM/DC mode selection(CPUFAN_SEL1, SYSFAN_SEL1)

The ASMB-784 contains a jumper that can support PWM or DC mode, Normally this jumper should be set with pin 1-2 closed. If you want to change to DC mode, set CPUFAN_SEL1, SYSFAN_SEL1 to 2-3 closed for disable.

Table 1.7: (CPUFAN_SEL1, SYSFAN_SEL1)

Function	Jumper Setting
*PWM mode	 1-2 closed
DC mode	 2-3 closed

Table 1.8: ATX/AT mode selector (PSON1)

Function	Jumper Setting
AT Mode	 1-2 closed
* ATX Mode	 2-3 closed
* default setting	

Table 1.9: Chassis intrusion switch type (JCASE1)

Function	Jumper Setting
NC* (Normal Close)	 NC 1-2 closed
NO (Normal Open)	 NO 2-3 closed
* default setting	

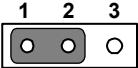
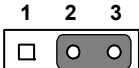
1.9 System Memory

ASMB-784 has four 240-pin memory sockets for DDR3 ECC/Non-ECC 1066/1333/1600 MHz memory modules with maximum capacity of 32GB (Maximum 8GB for each DIMM).

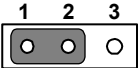
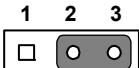
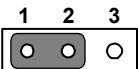
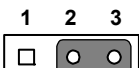
Please note that both versions ASMB-784 do NOT support registered DIMMs (RDIMMs).

1.10 Memory Installation Procedures

To install DIMMs, first make sure the two handles of the DIMM socket are in the “open” position. i.e. The handles lean outward. Slowly slide the DIMM module along the plastic guides on both ends of the socket, and then press the DIMM module right down into the socket, until you hear a click. This is when the two handles have automatically locked the memory module into the correct position of the DIMM socket. To remove the memory module, just push both handles outward, and the memory module will be ejected by the mechanism in the socket.

1.11 Cache Memory

The ASMB-784 supports a CPU with one of the following built-in full speed L3 caches:

The built-in third-level cache in the processor yields much higher performance than conventional external cache memories.

- 8 MB for 4th Generation Intel Xeon E3-1275 V3 CPU
- 8 MB for 4th Generation Intel Xeon-E3-1225 V3 CPU
- 8 MB for 4th Generation Intel Xeon-E3-1268 V3 CPU
- 4 MB for 4th Generation Intel Core i5-4570TE CPU

1.12 Processor Installation

The ASMB-784 is designed for LGA1150, Intel Xeon® E3 v3/4th Generation Core processor.

1.13 PCI Bus Routing Table

AD PCI slot INT	PCI_SLOT1	PCI_SLOT3	PCI_SLOT5
	AD16	AD17	AD18
A	A	B	C
B	B	C	D
C	C	D	A
D	D	A	B

Chapter 2

Connecting
Peripherals

2.1 Introduction

You can access most of the connectors from the top of the board as it is being installed in the chassis. If you have a number of cards installed, you may need to partially remove a card to make all the connections.

2.2 Parallel Port (LPT1)

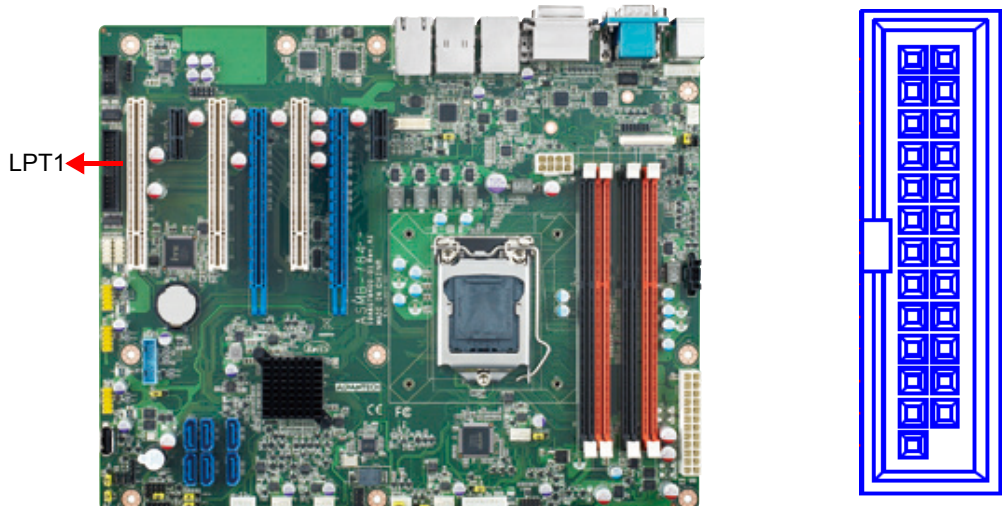

The parallel port is normally used to connect the motherboard to a printer. The ASMB-784 includes an onboard parallel port, accessed through a 25-pin flat-cable connector, LPT1.

2.3 USB Ports (LAN1_USB4_5, LAN2_USB0_1, USB2_3, USB6_7, USB8_9, USB10_11, USB12)

ASMB-784 provides up to 13 USB ports. USB4~12 are USB 2.0 ports supporting transmission rates up to 480 Mbps, and USB0~3 are USB 3.0 ports supporting transmission rate up to 5Gbps. These ports support Plug & Play and hot swapping for up to 127 external devices and are able to be disabled in BIOS menu.

The ASMB-784 is equipped with two or four high-performance 1000 Mbps Ethernet LANs. They are supported by all major network operating systems. The RJ-45 jacks on the rear plate provide convenient 1000 Mbps operation.

If all USB ports will be used, USB power is recommended to switch to +5V instead of +5VSB.

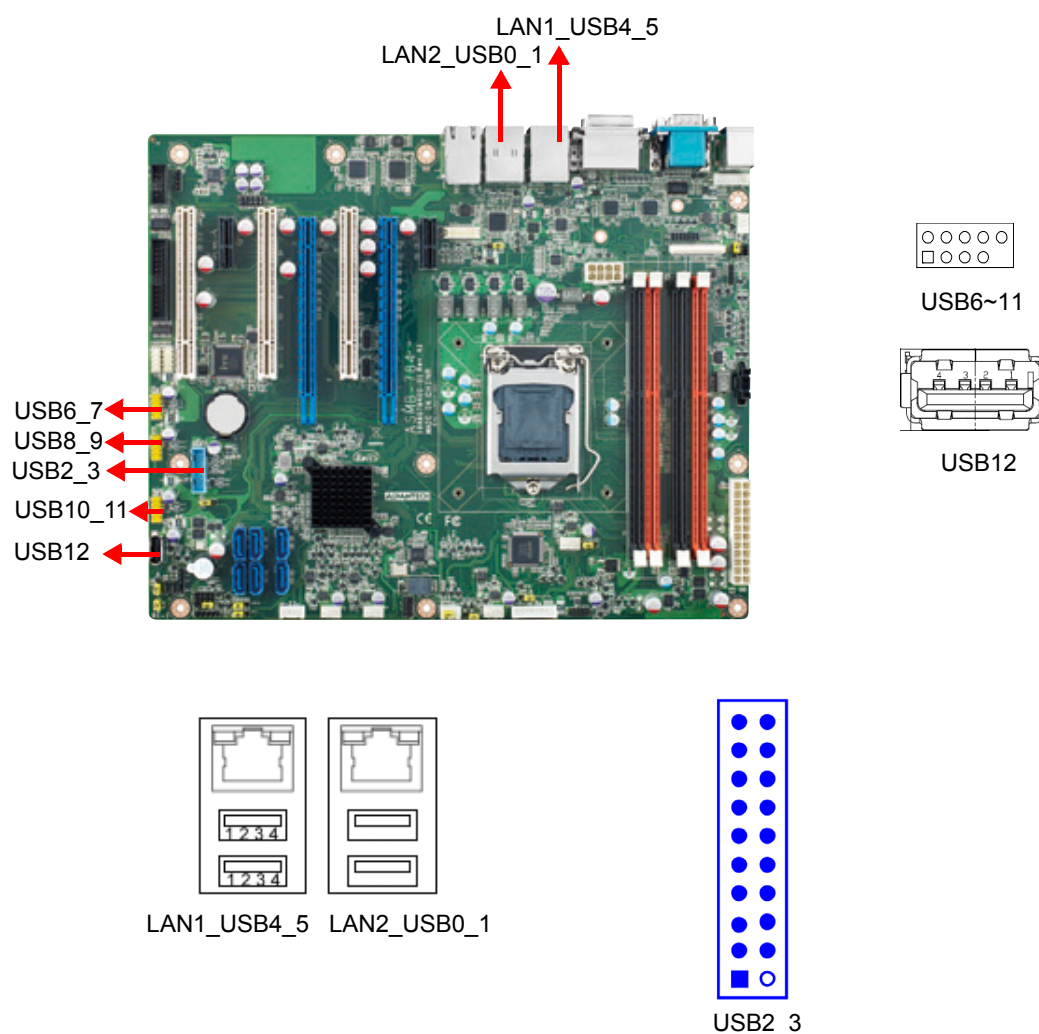

LAN 1/2 LED Indicator

LAN Mode	LAN Indicator
1 Gbps Link on	LED1 Green on (Left)
100 Mbps Link on	LED1 Orange on (Left)
10 Mbps Link on	LED1 N/A (Left)
Active	LED2 Green flash (Right)

LAN 3/4 LED Indicator

LAN Mode	LAN Indicator
1 Gbps Link on	LED1 Green on (Right)
100 Mbps Link on	LED1 Orange on (Right)
10 Mbps Link on	LED1 N/A (Right)
Active	LED2 Green flash (Left)

2.4 USB Power Switch

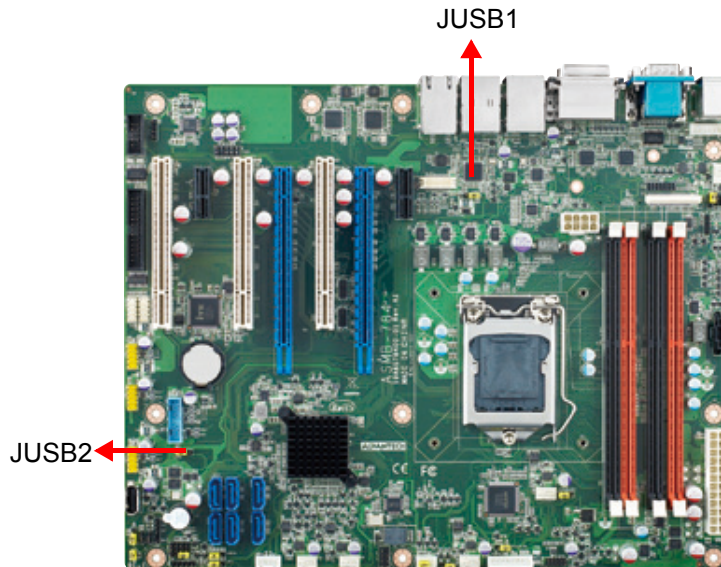

Jumper	USB Ports
JUSB1	USB0_1 and USB4_5
JUSB2	USB2_3, USB6_7, USB8_9, USB10_11, USB12

ASMB-784 allows user to set USB power between +5VSB and +5V. When the jumper is set as +5V, the board doesn't support S3/S4.

Note! When USB power is switched to +5V, it can't be connected with powered USB KVM.



2.5 VGA Connector (VGA1)

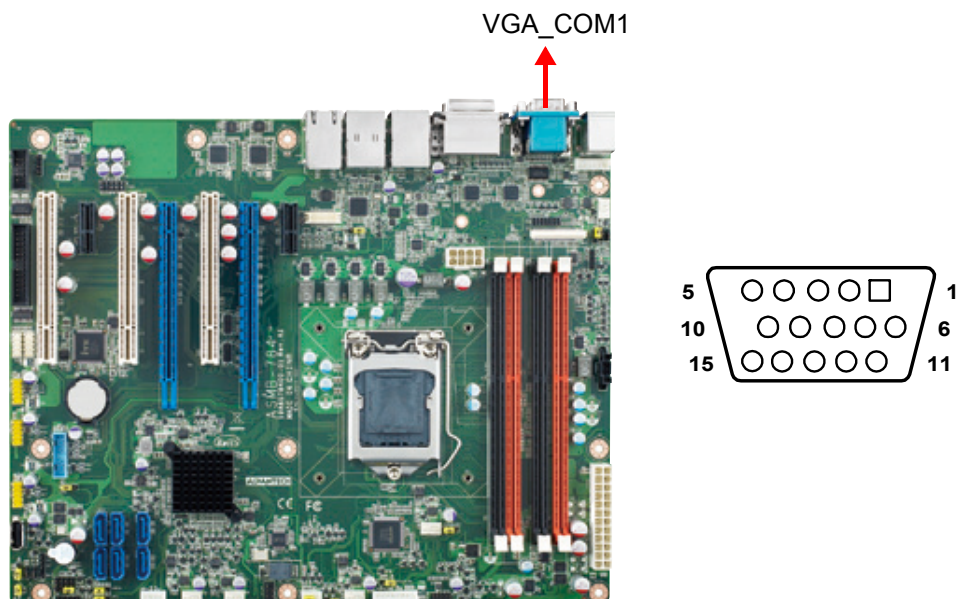

The ASMB-784 includes a VGA interface that can drive conventional CRT displays. Pin assignments of VGA1 are detailed in Appendix B.

2.6 Serial Ports (COM1, COM2)

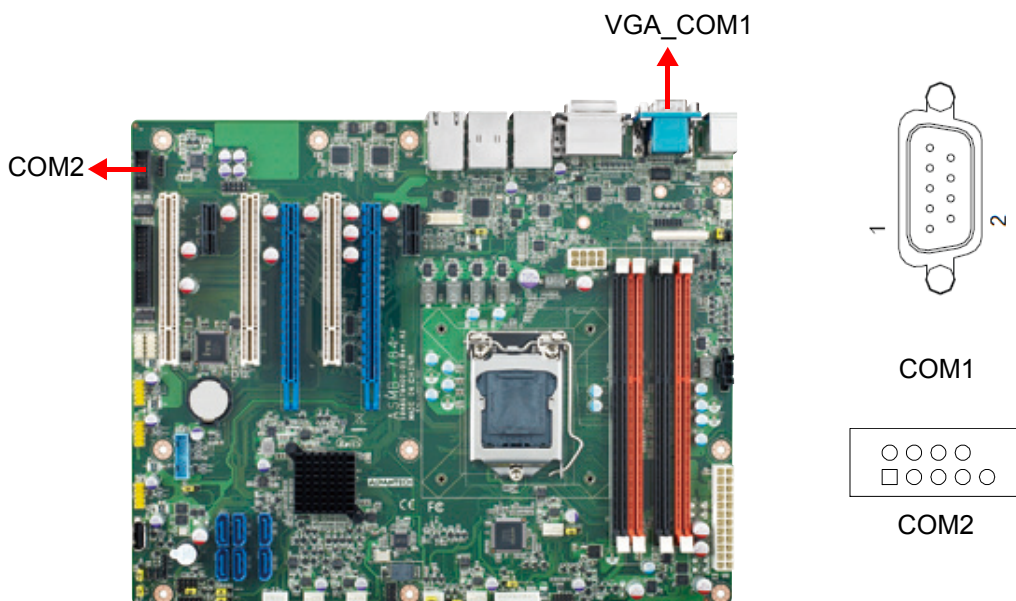

The ASMB-784 offers two serial ports (one on the rear panel and one onboard). These ports can connect to a serial mouse, printer or communications network. The IRQ and address ranges for those ports are fixed. However, if you want to disable the port or change these parameters later, you can do this in the system BIOS setup. Different devices implement the RS-232 standards in different ways. If you are having problems with a serial device, please be sure to check the pin assignments for the connector.

2.7 PS/2 Keyboard and Mouse Connector (KBMS1) and External Keyboard & Mouse (KBMS2)

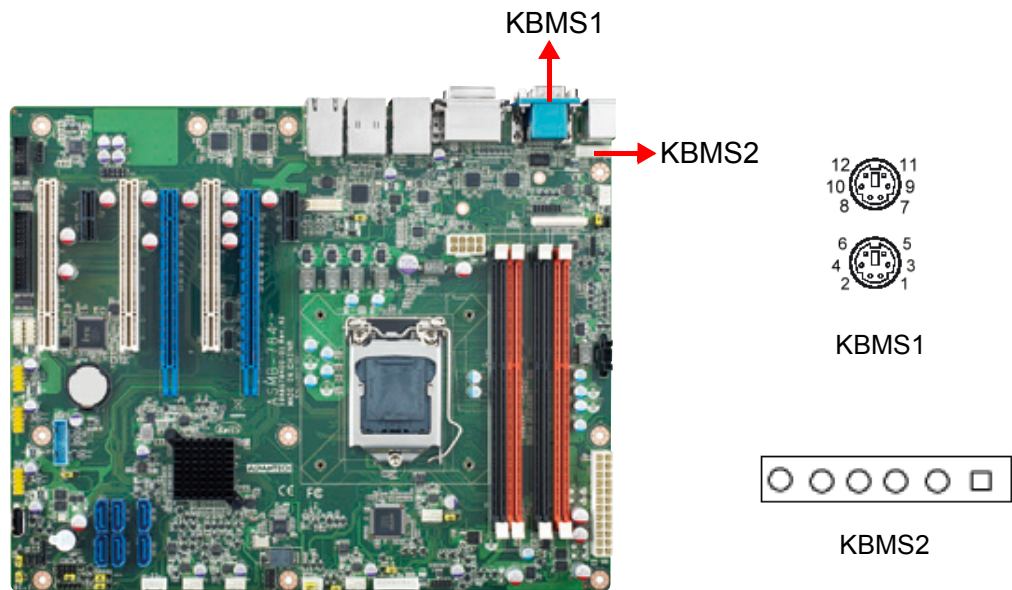

Two 6-pin mini-DIN connectors (KBMS1) on the rear panel of the motherboard provide PS/2 keyboard and mouse connections, and there is also an extra onboard external keyboard and mouse connector on the motherboard. This gives system integrators greater flexibility in designing their systems.

2.8 CPU Fan Connector (CPUFAN0)

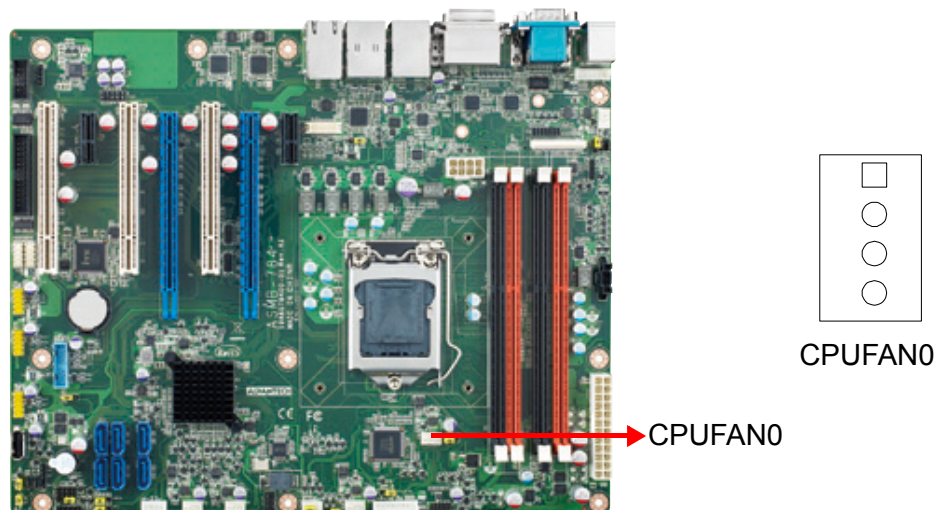

If a fan is used, this connector supports cooling fans that draw up to 500 mA (6 W).

2.9 System FAN Connector (SYSFAN0, SYSFAN1, SYSFAN2 and SYSFAN3)

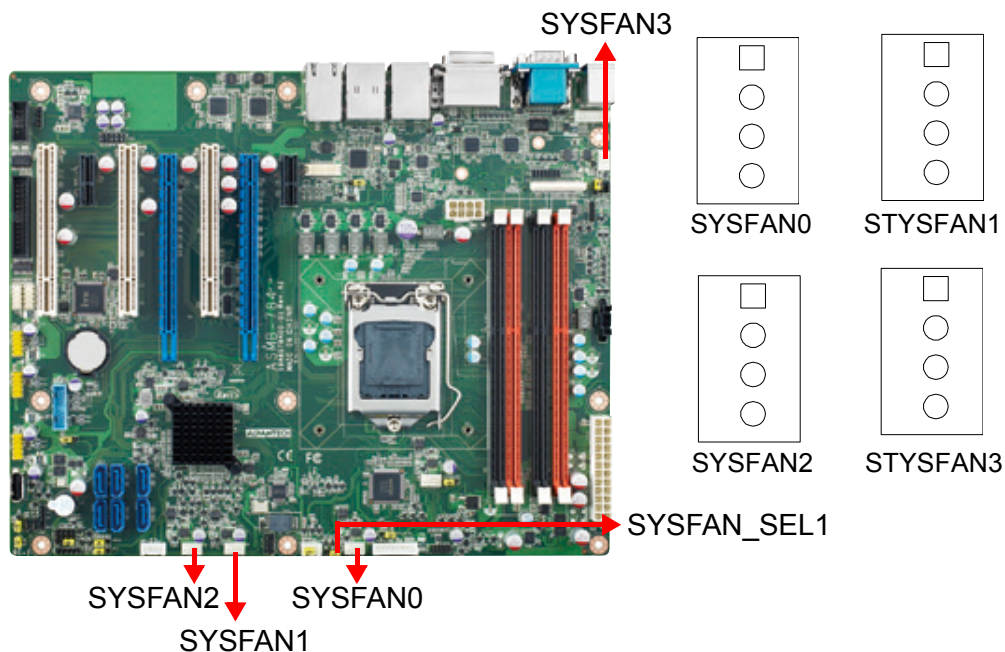

If a fan is used, this connector supports cooling fans that draw up to 1A (12W).

2.10 Front Panel Connectors (JFP1~3)

There are several external switches and LEDs to monitor and control the ASMB-784.

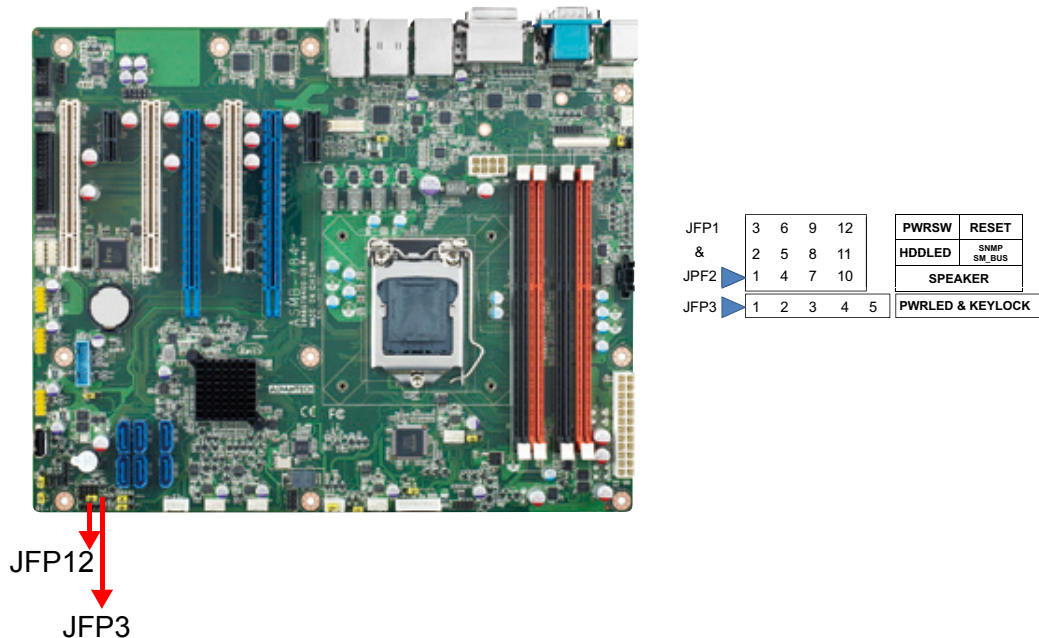

2.10.1 Power LED (JFP3)

JFP3 is a 5-pin connector for the power LED. Refer to Appendix B for detailed information on the pin assignments. If a PS/2 or ATX power supply is used, the system's power LED status will be as indicated as follows.

Table 2.1: PS/2 or ATX power supply LED status

Power mode	LED (PS/2 power)	LED (ATX power)
System On	On	On
System Suspend	Fast Flash	Fast Flash
System Off	Off	Off
System Off in deep sleep	Off	Off

2.10.2 External Speaker (JFP2 pins 1, 4, 7, 10)

JFP2 pins 1, 4, 7, 10 connector for an external speaker. The ASMB-784 provides an onboard buzzer as an alternative. To enable the buzzer, set pins 7-10 as closed.



2.10.3 HDD LED Connector (JFP1 pins 2 & 5)

You can connect an LED to connector JFP1 to indicate when the HDD is active.

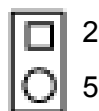

2.10.4 ATX Soft Power Switch (JFP1 pins 3 & 6)

If your computer case is equipped with an ATX power supply, you should connect the power on/off button on your computer case to pins 3 and 6 of JFP1. This connection enables you to turn your computer on and off.

2.10.5 Reset Connector (JFP1 pins 9 & 12)

Many computer cases offer the convenience of a reset button.

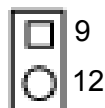

2.10.6 SNMP SMBus Connector (JFP2 pins 8 & 11)

ASMB-784 supports Advantech SNMP-1000 module for providing a platform independent system management. When you're installing SNMP-1000 module on ASMB-784, please connect it to pins 8 and 11 of JFP2. (Pin 8 is data pin, pin 11 is clock pin)

2.11 8-pin Alarm Board Connector (VOLT1)

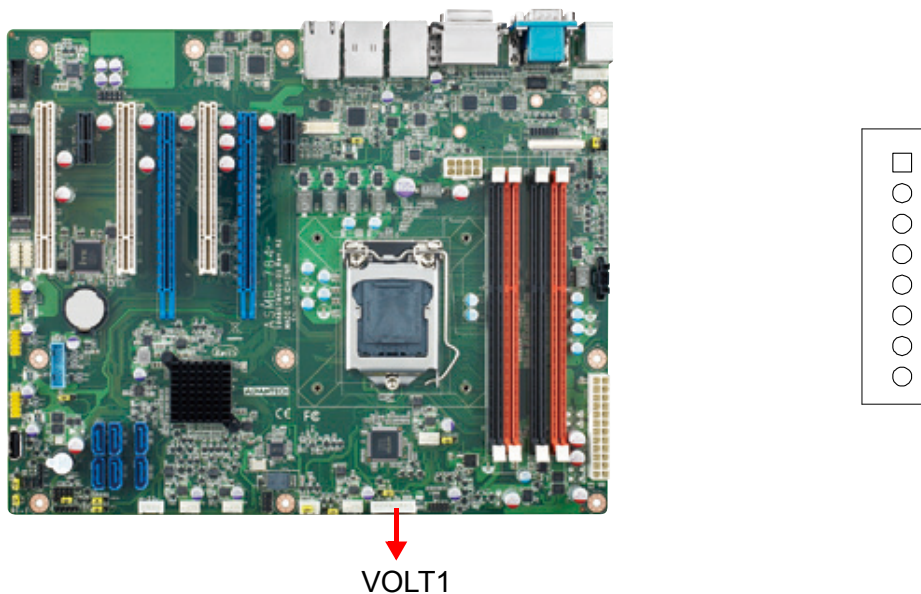

VOLT1 connects to the alarm board of Advantech chassis. These alarm boards give warnings if a power supply or fan fails, if the chassis overheats.

2.12 Case Open Connector (JCASE1)

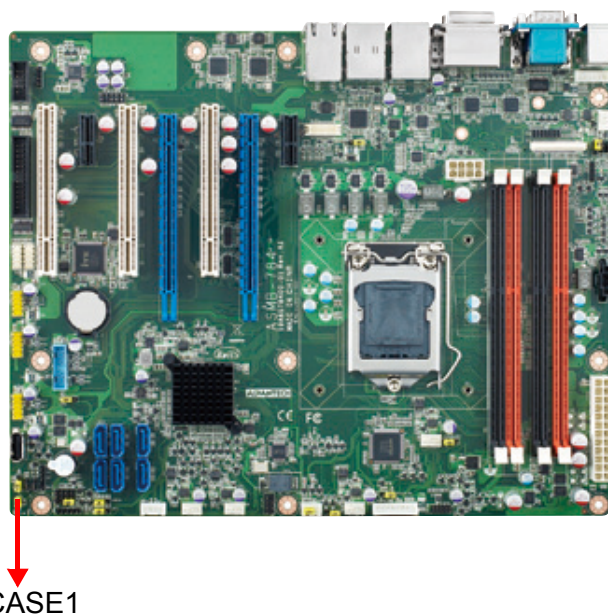

JCASE1 is for chassis with a case open sensor. The buzzer on the motherboard sounds if the case is opened.

2.13 Front Panel LAN Indicator Connector (LANLED1)

Table 2.2: Front Panel LAN Indicator Connector

Pin	Signal	Pin	Signal
1	LAN1/3_LED0_ACT	2	LAN2/4_LED1_ACT
3	VCC3_LAN1/3LED	4	VCC3_LAN2/4LED
6	LAN1/3_LED1_1000M	6	LAN2/4_LED2_1000M
7	LAN1/3_LED2_100M	8	LAN2/4_LED0_100M
9	VCC3	10	NC

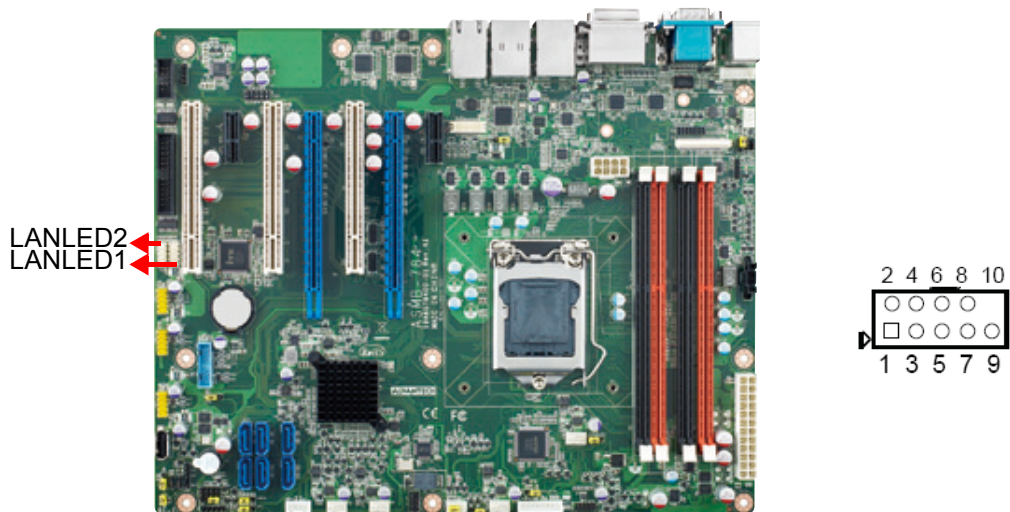

2.14 Serial ATA Interface (SATA0~5)

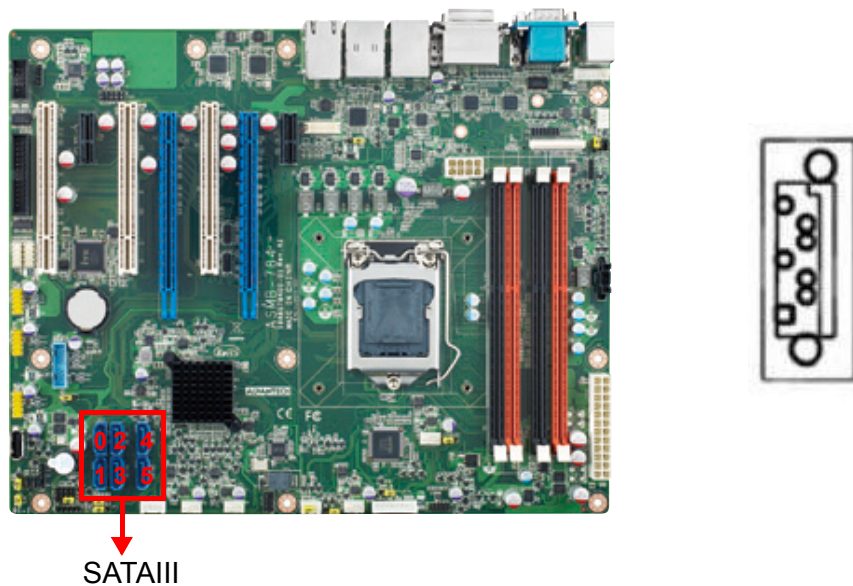

ASMB-784 features six high performance serial ATA III interfaces (up to 600 MB/s, blue connector).

2.15 PCI Slots (PCI_SLOT1, PCI_SLOT3, PCI_SLOT5)

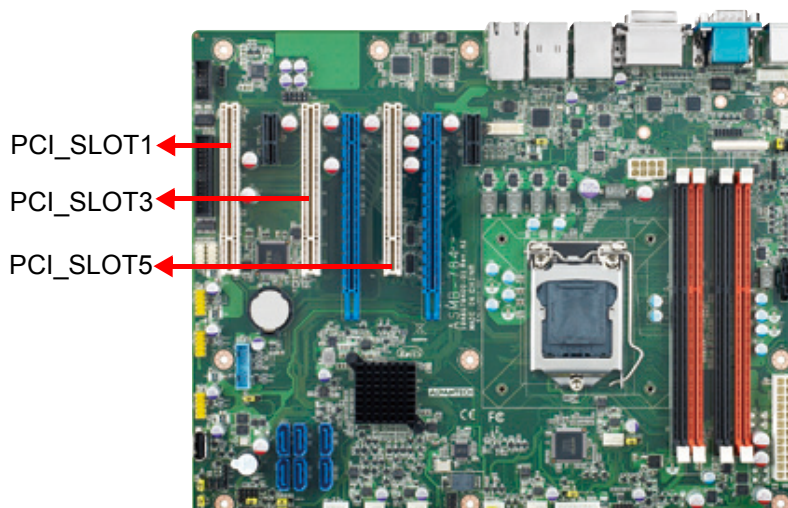

There are three 32-bit PCI slots designed on ASMB-784, and default clock is 33 MHz. PCI clock could be selected between 33 or 66 MHz by JPCICLK1 jumper, and please refer section of 2.21.

2.16 PCIe x16 Expansion Slots (PCIEX16_SLOT4 and PCIEX16_SLOT6)

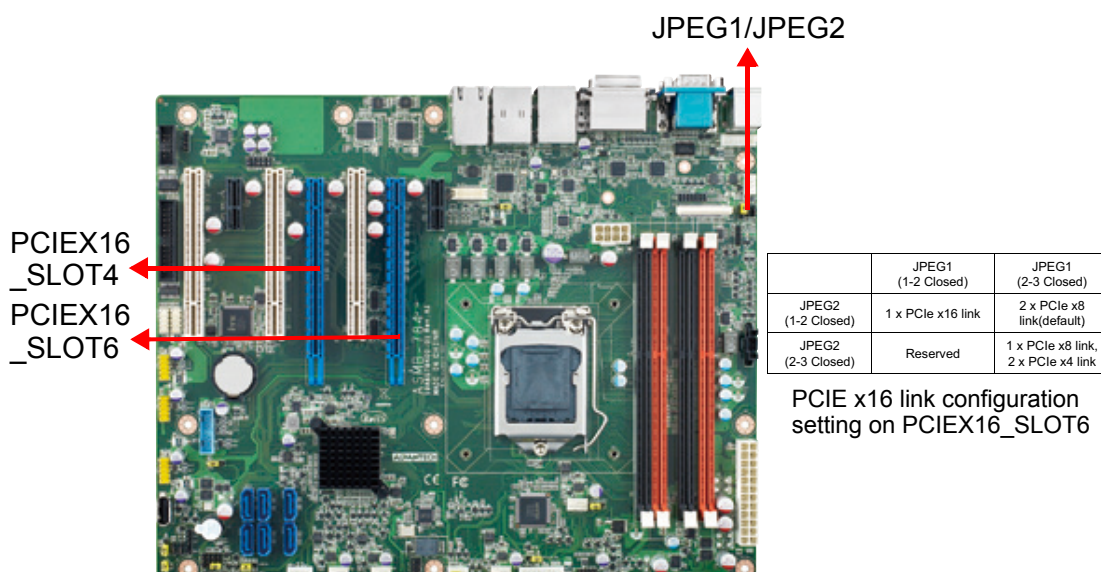

The ASMB-784 provides one PCIe x16 slot (x16 link) or two PCIe x16 slots (x8 link) for users to install add-on VGA cards when their applications require higher graphics performance than the CPU embedded graphics controller can provide, or high bandwidth demanded I/O card, such as frame grabber card, RAID card and 10G LAN card. One x16 link on PCIEX16_SLOT6 or two x8 link on PCIEX16_SLOT6 & SLOT4 could be set via JPEG1 and JPEG2.

Note! *If there is only one PCIe x16 card will be installed on PCIEX16_SLOT6, JPEG1 & JPEG2 is strongly to set as 1 PCIe x16 link (Both JPEG1 and JPEG2 are 1-2 closed).*



2.17 PCIe x1 Expansion Slots (PCIEX1_SLOT2, PCIEX1_SLOT7)

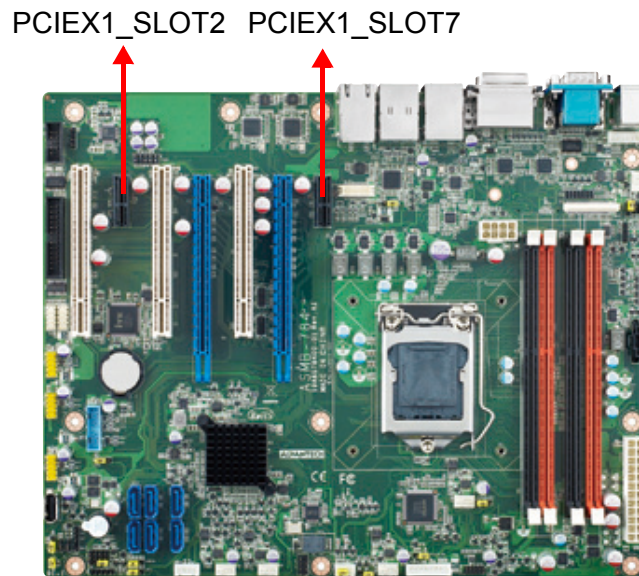

2.18 Auxiliary 8-pin Power Connector (ATX12V1)

For a fully configured system, we recommend that you use a power supply unit (PSU) that complies with ATX 12 V Specification 2.0 (or later version). Do not forget to connect the 8-pin EATX12 V power plug; otherwise, the system will not boot.

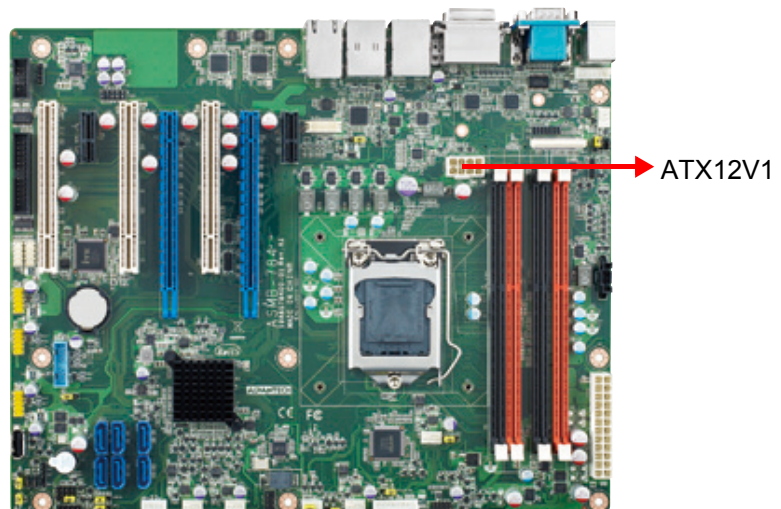

2.19 SPI Flash Connector(SPI_CN1)

The SPI flash card pin header can be used to flash the BIOS. NOTE: ASMB-784 must be OFF when flashing the BIOS.

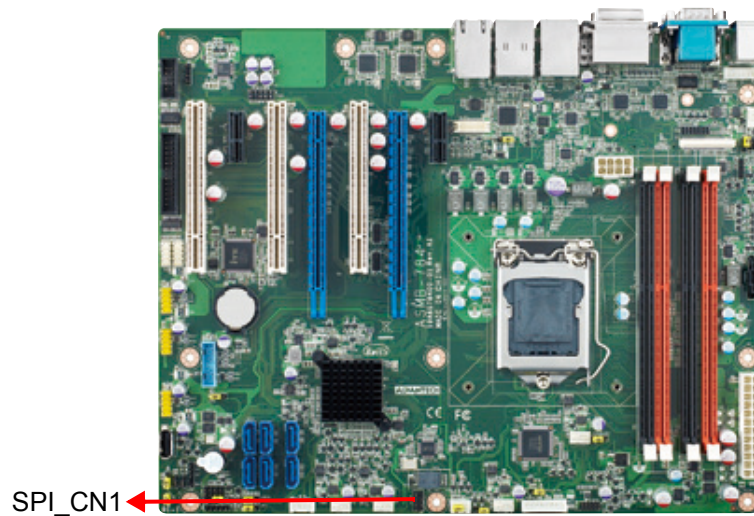

2.20 Low Pin Count Connector (LPC1)

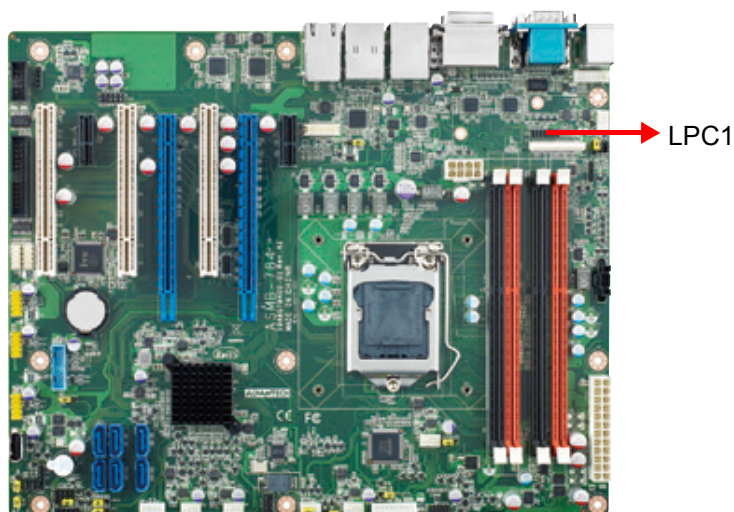

LPC connector on AIMB-784 is reserved for Advantech LPC modules.

Table 2.3: Advantech LPC Module List

Pin	Signal
PCA-TPM-00A1E	TPM Module

2.21 PCI Clock Selection (JPCICLK1)

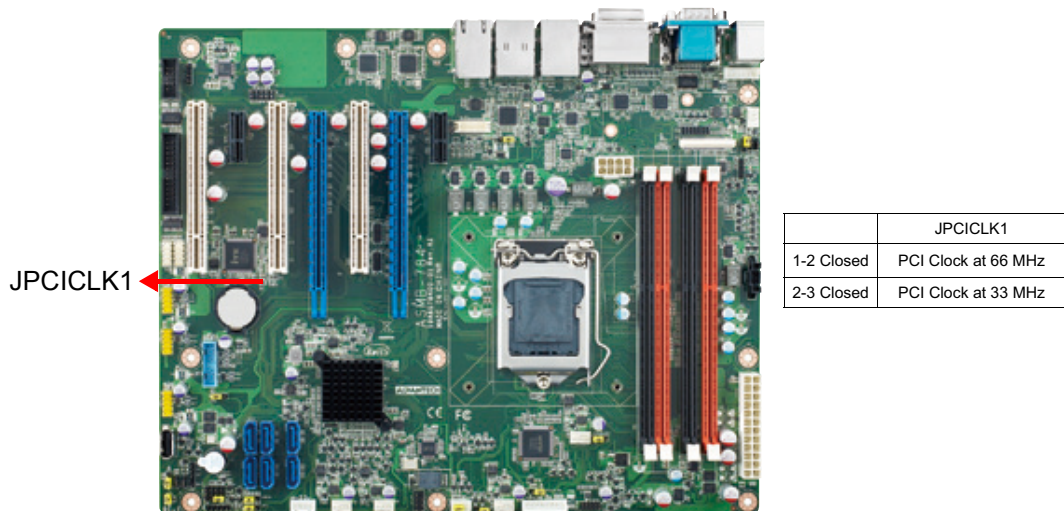

JPCICLK1 is a jumper to select PCI slot clock between 66 or 33 MHz, and the default setting is 33 MHz (2-3 closed).

2.22 KBMS Power Selection (JKBMS1)

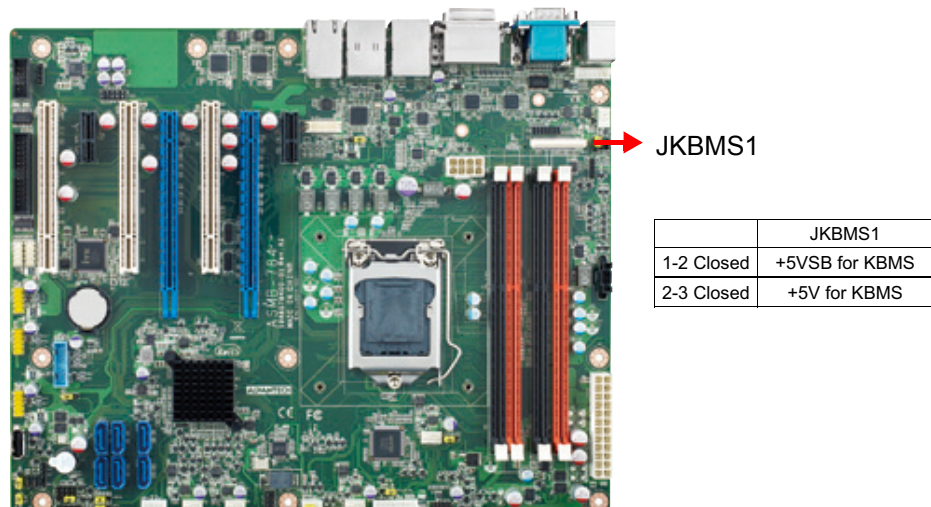

ASMB-784 allows user to set keyboard and mouse power between +5VSB and +5V. When the jumper is set as +5V, the board doesn't support S3/S4.

Note! When KBMS power is switched to +5V, it can't be connected with powered PS/2 KVM.



Chapter 3

BIOS Operation

3.1 Introduction

AMIBIOS has been integrated into myriad motherboards for decades. In the past, people often referred to the AMIBIOS setup menu as BIOS, BIOS setup or CMOS setup.

With the AMIBIOS Setup program, you can modify BIOS settings and control the special features of your computer. The Setup program uses a number of menus for making changes and turning the special features on or off. This chapter describes the basic navigation of the ASMB-784 setup screens.



Figure 3.1 Main setup screen

AMI's BIOS ROM has a built-in Setup program that allows users to modify the basic system configuration. This information is stored in NVRAM area so it retains the Setup information when the power is turned off.

3.2 Entering BIOS Setup

Press or <Esc> at bootup to enter AMI BIOS Setup Utility, the Main Menu will appear on the screen. Use arrow keys to select among the items and press <Enter> to accept or enter the sub-menu.

When users first enter the BIOS Setup Utility, they enter the Main setup screen. Users can always return to the Main setup screen by navigating to the Main tab. There are two Main Setup options. They are described in this section. The Main BIOS Setup screen is shown below.

3.2.1 Main Menu

Press or <Esc> at bootup to enter AMI BIOS CMOS Setup Utility, the Main Menu will appear on the screen. Use arrow keys to select among the items and press <Enter> to accept or enter the sub-menu.



Figure 3.2 Main setup screen

The Main BIOS setup screen has two main frames. The left frame displays all the options that can be configured. Grayed-out options cannot be configured; options in blue can be. The right frame displays the key legend.

Above the key legend is an area reserved for a text message. When an option is selected in the left frame, it is highlighted in white. Often a text message will accompany it.

3.2.2 System time / System date

Use this option to change the system time and date. Highlight System Time or System Date using the <Arrow> keys. Enter new values through the keyboard. Press the <Tab> key or the <Arrow> keys to move between fields. The date must be entered in MM/DD/YY format. The time must be entered in HH:MM:SS format.

3.3 Advanced BIOS Features Setup

Select the Advanced tab from the ASMB-784 setup screen to enter the Advanced BIOS setup screen. You can select any of the items in the left frame of the screen, such as CPU configuration, to go to the sub menu for that item. You can display an Advanced BIOS Setup option by highlighting it using the <Arrow> keys. All Advanced BIOS Setup options are described in this section. The Advanced BIOS Setup screens are shown below. The sub menus are described on the following pages.

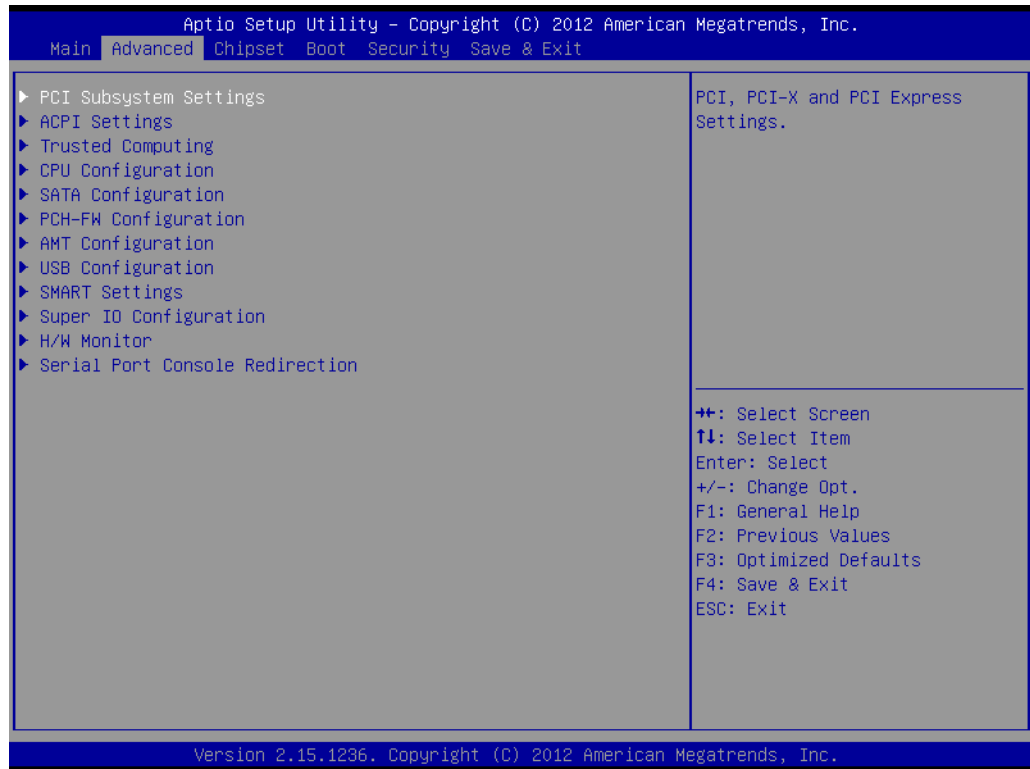

Figure 3.3 Advanced BIOS features setup screen

3.3.1 PCI Subsystem Settings

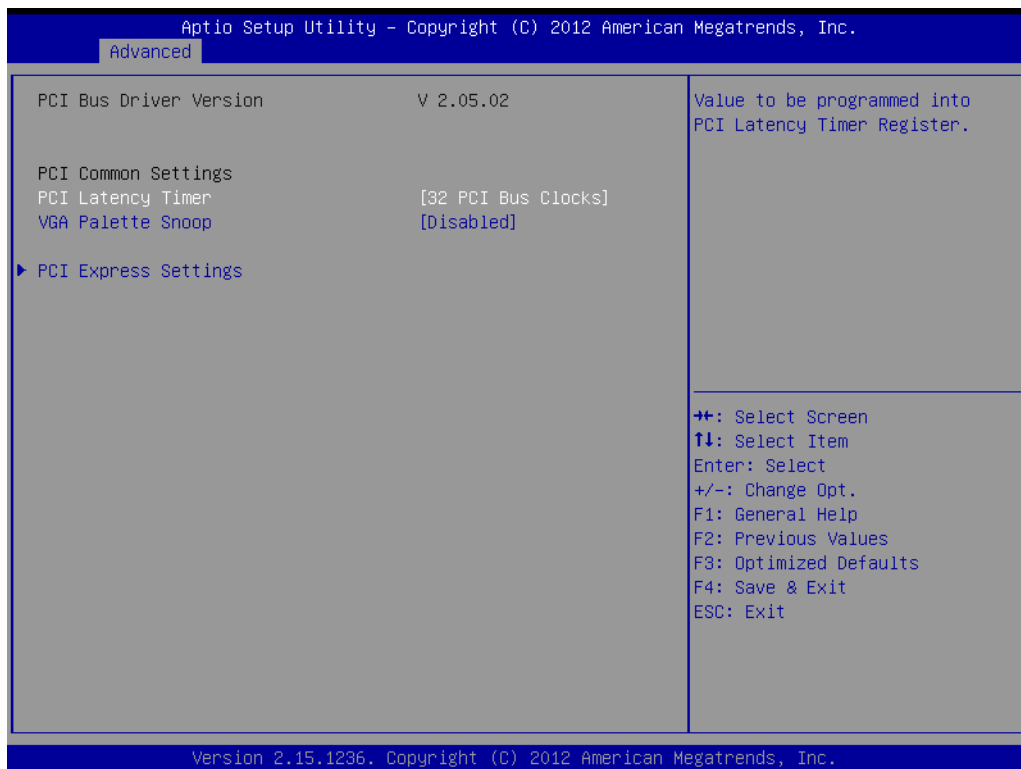

Figure 3.4 PCI subsystem settings screen

PCI Latency Timer

Value in units of PCI clocks for PCI device latency timer register.

VGA Palette Snoop

This item is designed to solve problems caused by some non-standard VGA cards.



Figure 3.5 PCI Express Setting

Relaxed Ordering

This item is to enable or disable PCIe device relaxed ordering.

Extended Tag

If this item is [Enabled], it allows device to use 8-bit tag field as a requester.

No Snoop

This item is to enable or disable PCIe device with "No Snoop" option.

Maximum Payload

This item is to set maximum payload of PCIe device or allow system BIOS to select the value.

Maximum Read Request

This item is to set maximum read request size of PCIe device or allow system BIOS to select the value.

ASPM Support

This item is to set the ASPM level. [Auto]: BIOS auto configure; [Force L0s]: Force all links to L0s state; [Disable]: To disable ASPM. Extended Synch

If this item is [Enable], it allows generation of extended synchronization patterns.

Link Training Retry

This item is to allow user to define numbers of retry attempts software will take to retrain the link if previous training attempt was unsuccessful.

Link Training Time out

To define number of microseconds waiting for "Link Training", and the value range is from 10 to 1000 uS.

Unpopulated Links

In order to save power, software will disable unpopulated PCIe links, if this option set to [Disable Link].

Restore PCIE Registers

On non-PCIe aware OS (pre Windows Vista) some devices may not be correctly re initialized after S3. Enabling this restores PCIe device configurations on S3 resume. When enabling this item, it may cause issues with other hardware after S3 resume.

3.3.2 ACPI Settings

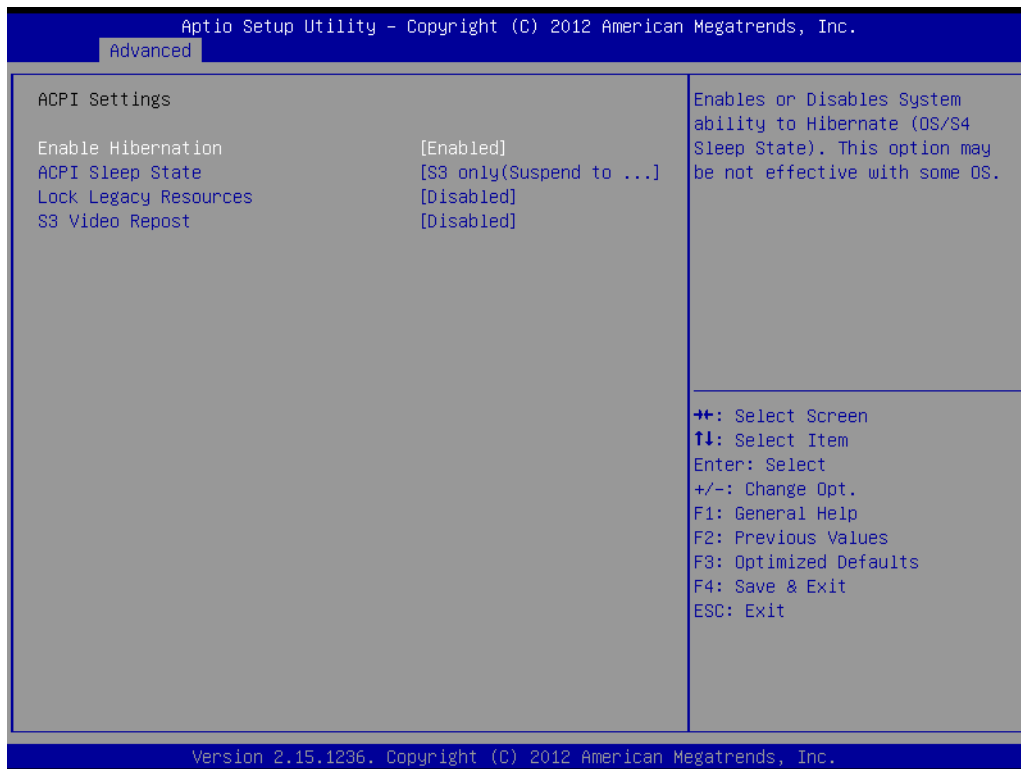

Figure 3.6 ACPI Settings

Enable Hibernation

"Enable" or "disable" Hibernation.

ACPI Sleep State

Specifies the ACPI sleep state when the system enters suspend.

Lock Legacy Resources

"Enable" or "Disable" Lock Legacy Resources.

S3 Video Repost

This item is to enabled or disabled S3 video repost.

3.3.3 Trusted Computing

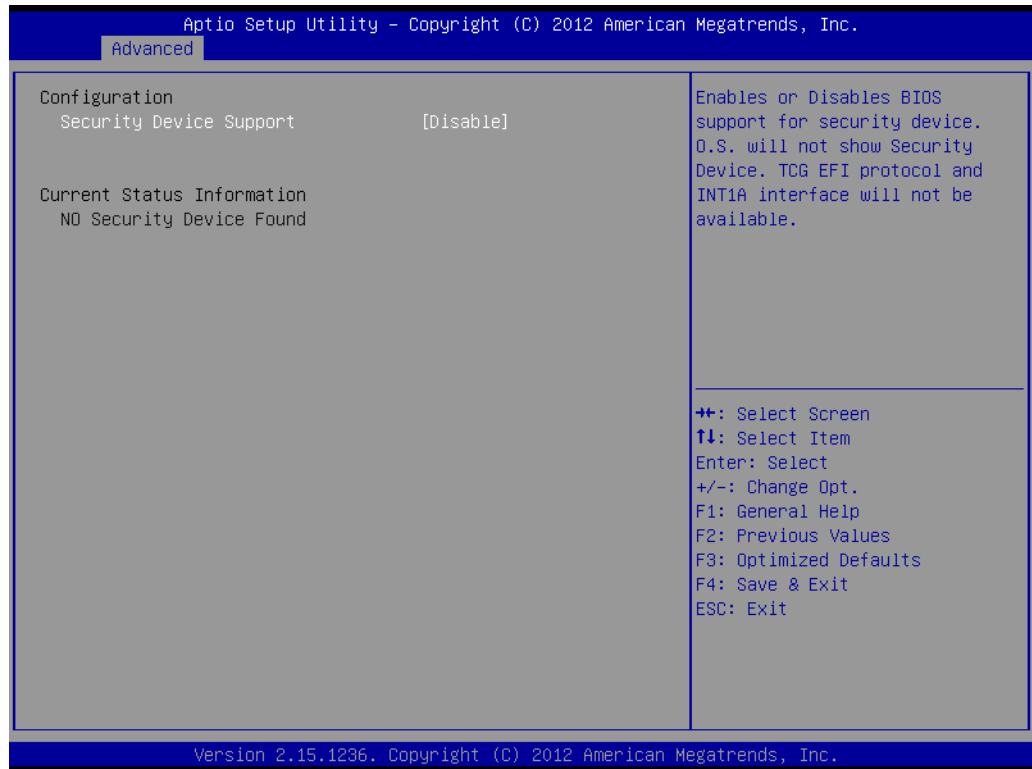

Figure 3.7 TPM Settings

Security Device Support

“Enable” or “disable” TPM Support. You can purchase Advantech LPC TPM module to enable TPM function. P/N: PCA-TPM-00A1E

3.3.4 CPU Configuration

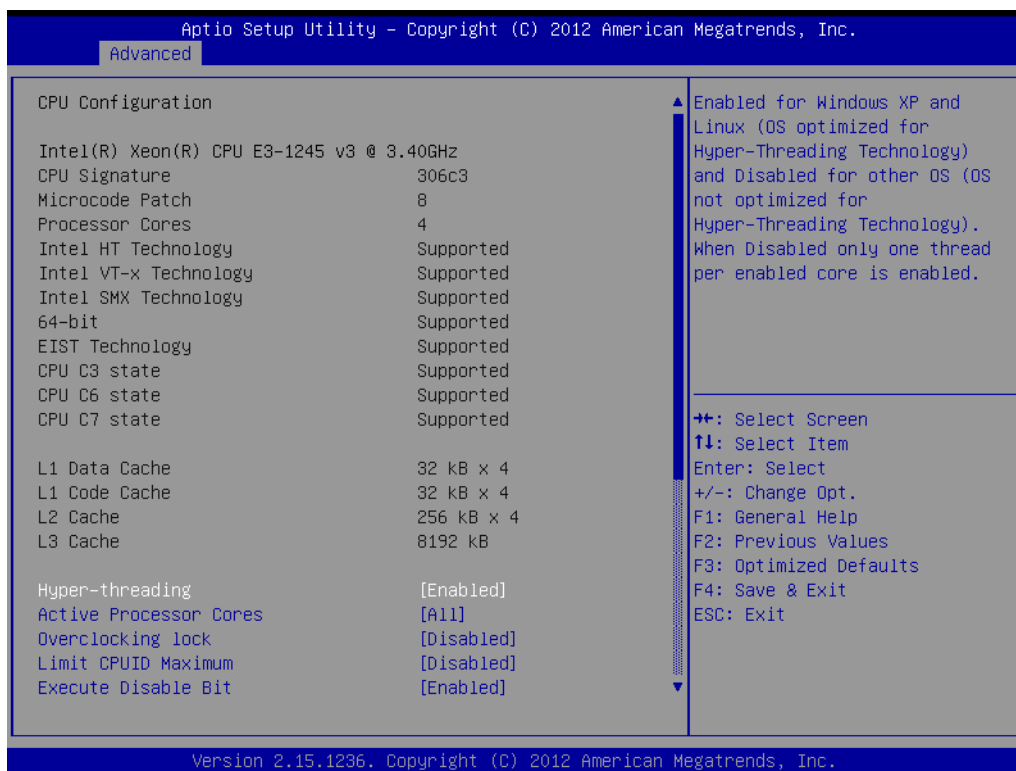

Figure 3.8 CPU Configuration

Hyper-threading

This item allows you to enable or disable Intel Hyper Threading technology.

Active Processor Core

Use this to select how many processor cores you want to activate when you are using a dual or quad core processor.

Overclocking lock

This item is to enable or disabled FLEX_RATIO(194) MSR.

Limit CPUID Maximum

Setting this item to [Enable] allows legacy operating systems to boot even without support for CPUs with extended CPUID functions.

Execute Disable Bit

This item specifies the Execute Disable Bit Feature. The settings are Enabled and Disabled. The Optimal and Fail-Safe default setting is Enabled. If Disabled is selected, the BIOS forces the XD feature flag to always return to 0.

Intel Virtualization Technology

This feature is used to enable or disable the Intel Virtualization Technology (IVT) extension. It allows multiple operating systems to run simultaneously on the same system. It does this by creating virtual machines, each running its own x86 operating system.

Hardware Prefetcher

Hardware Prefetcher is a technique that fetches instructions and/or data from memory into the CPU cache memory well before the CPU needs it, so that it can improve the load-to-use latency. You may choose to enable or disable it.

Adjacent Cache Line Prefetch

The Adjacent Cache-Line Prefetch mechanism, like automatic hardware prefetch, operates without programmer intervention. When enabled through the BIOS, two 64-byte cache lines are fetched into a 128-byte sector, regardless of whether the additional cache line has been requested or not. You may choose to enable or disable it.

CPU AES

This item is to enable or disable CPU advanced encryption standard instructions.

EIST

This item is to enable or disable Intel Speedstep function.

Turbo Mode

This item is to enable or disable turbo mode.

CPU C States

This item is to enable or disable CPU C states.

Enhanced C1 state

This item is to enable or disable enhanced C1 state.

CPU C3 Report

Enable/disable CPU C3 report to OS.

CPU C6 Report

Enable/disable CPU C6 report to OS.

CPU C7 Report

Enable/disable CPU C7 report to OS.

C state Pre-Wake

Enable/disable C state Pre-Wake feature.

Package C State limit

This item is to enable or disable package C state limit.

Intel TXT(LT) Support

This item is to enable or disable Intel TXT(LT) support.

ACPI T State

This item is to enable or disable ACPI T state support.

3.3.5 SATA Configuration

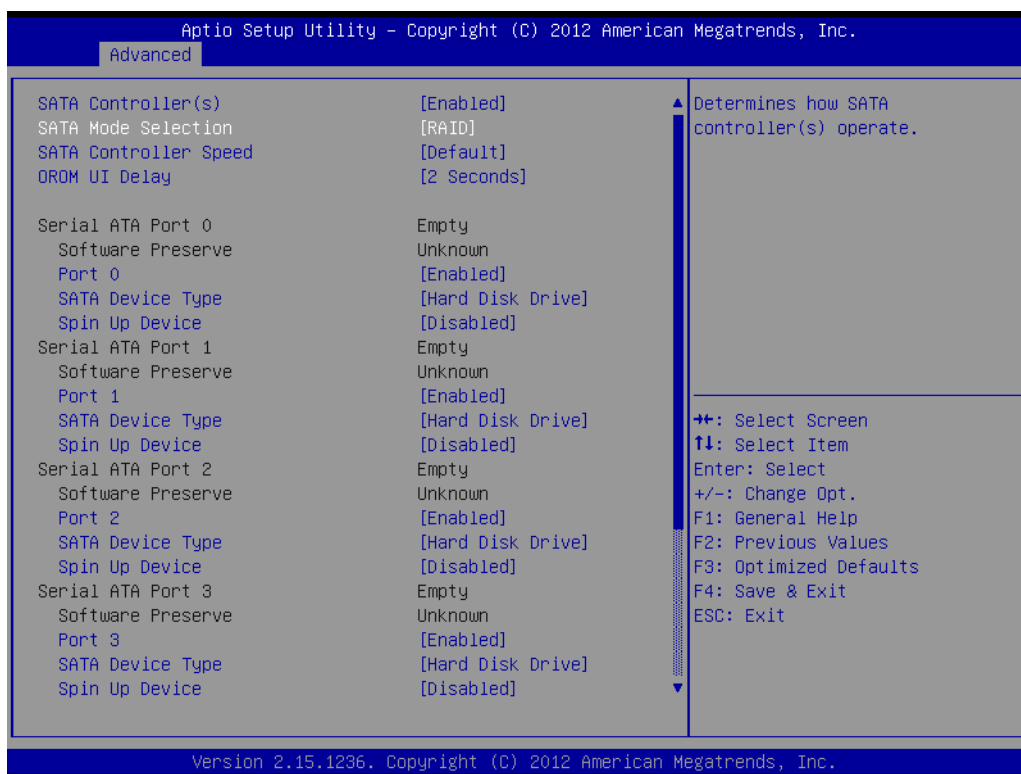

Figure 3.9 SATA Configuration

SATA Controller(s)

This item is to enable or disable SATA devices.

SATA Mode Selection

Set as IDE, AHCI, or RAID when SATA Controllers are enabled.

SATA Controller Speed

Sets the maximum speed of SATA controllers, there are three modes, Gen1, Gen2, and Gen3.

OROM UI Delay

When this item is enabled, users indicate the delay of the OROM UI Splash Screen in a normal status.

Port 0~5

To enable or disable SATA port 0~5.

Port 0~5 Device Type

To identify the SATA is connected to Solid State Drive or Hard Disk Drive.

Port 0~5 Spin Up Device

On an edge detect from 0 to 1, the PCH starts a COMRESET initialization sequence to the device.

3.3.6 PCH-FW Configuration

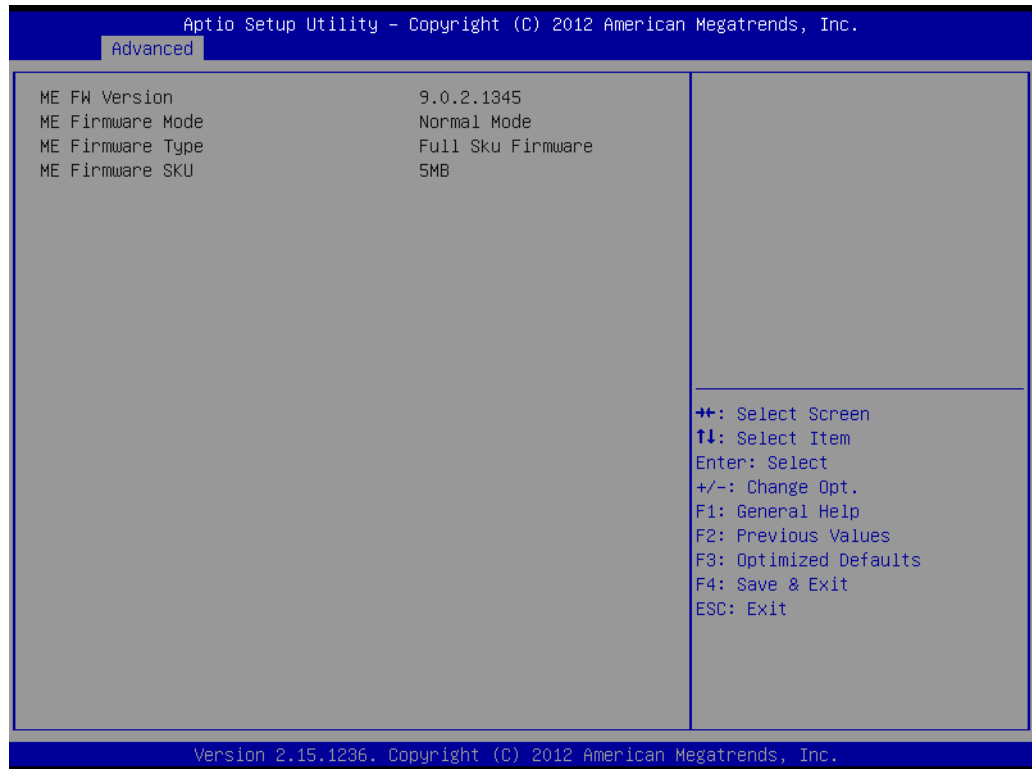

Figure 3.10 Intel ME FW Configuration Information

This page shows the Intel ME configuration

3.3.7 AMT Configuration

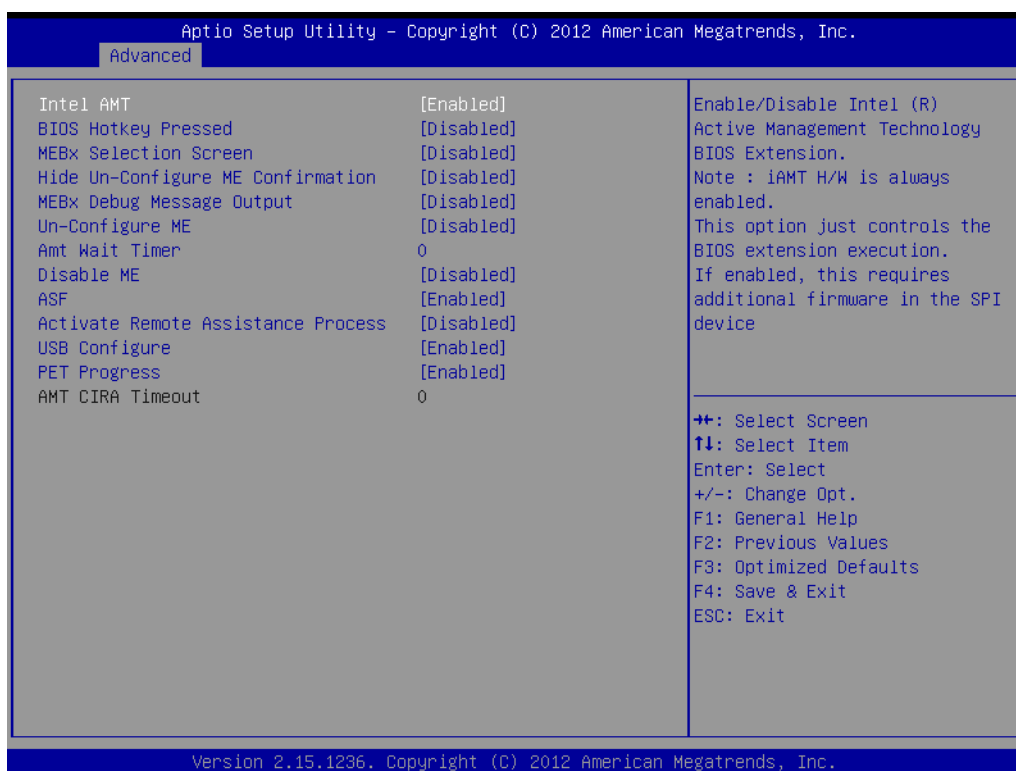

Figure 3.11 AMT Configuration

Intel AMT

Enable or Disable Intel Active Management Technology BIOS Extension.

BIOS Hotkey Pressed

To enable or disable BIOS hotkey press.

MEBx Selection Screen

“Enable or Disable” MEBx selection screen.

Hide Un-Configure ME Confirmation

Hide un-configuration ME without password confirmation prompt.

MEBx Debug Message Output

Enable MEBx debug message output.

Un-Configure ME

To un-configure ME without password.

AMT Wait Timer

To set a waiting time before sending ASF_BOOT_OPTIONS.

Disable ME

Set ME to Soft temporary disable.

ASF

Enable or disable Alert Specification format.

Activate Remote Assistance Process

To trigger CIRA boot.

USB Configure

To enable or disable USB configure function.

PET Progress

Enable or disable PET event progress to receive PET events.

3.3.8 USB Configuration

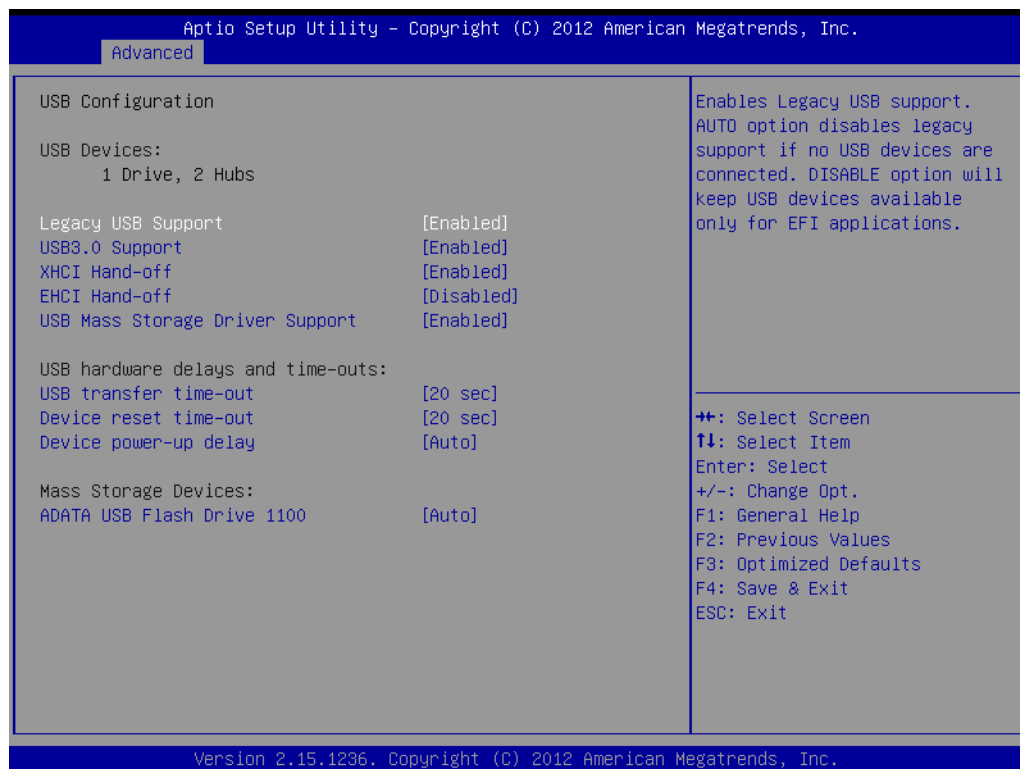

Figure 3.12 USB Configuration

Legacy USB Support

This is for supporting USB devices under legacy OS such as DOS. When choosing "AUTO", the system will automatically detect if any USB device is plugged into the computer and enable USB legacy mode and disable USB legacy mode when no USB device is plugged in.

USB3.0 Support

Enables or disables USB 3.0 (XHCI) support

XHCI Hand-off

Enables or disables support for OS without XHCI hand-off features.

EHCI Hand-off

This enables or disables support for an OS without EHCI hand-off features.

USB Mass Storage Driver Support

To enable or disable USB mass storage driver support.

USB transfer time-out

Allows you to select the USB transfer time-out value. [1,5,10,20sec]

Device reset time-out

Allows you to select the USB device reset time-out value. [10,20,30,40 sec]

Device power-up delay

This item appears only when you set the Device power-up delay item to [manual].

3.3.9 SMART Settings

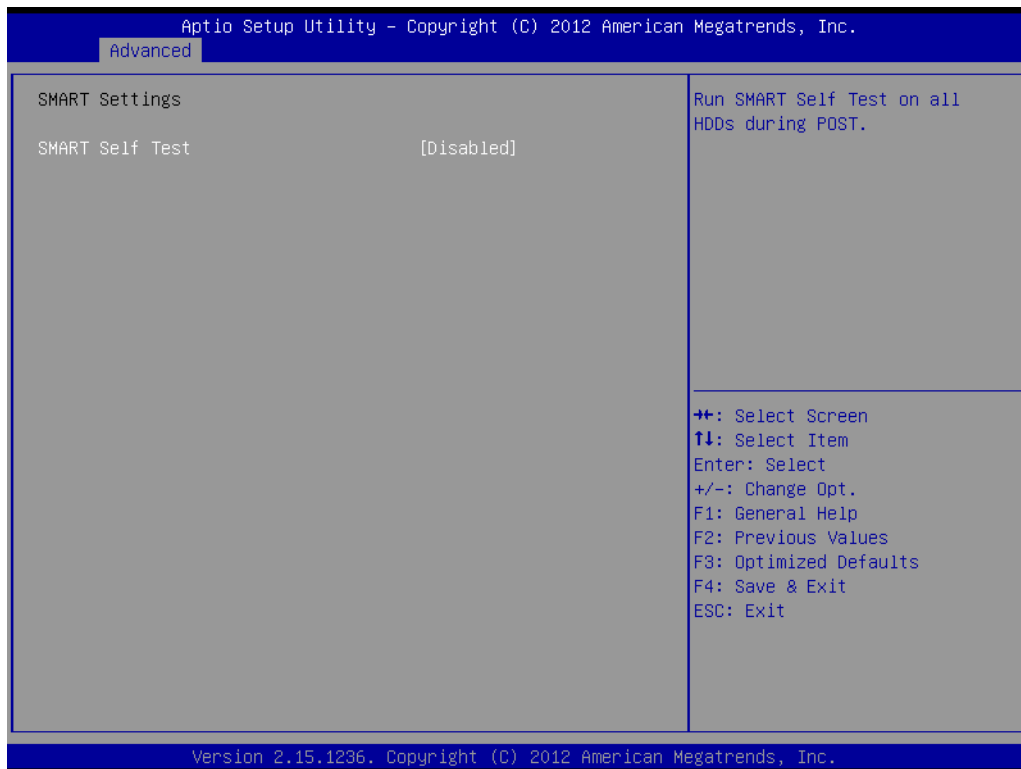

Figure 3.13 SMART Setting

SMART Self Test

This item is to enable or disable SMART self test on all HDDs during post.

3.3.10 Super IO Configuration

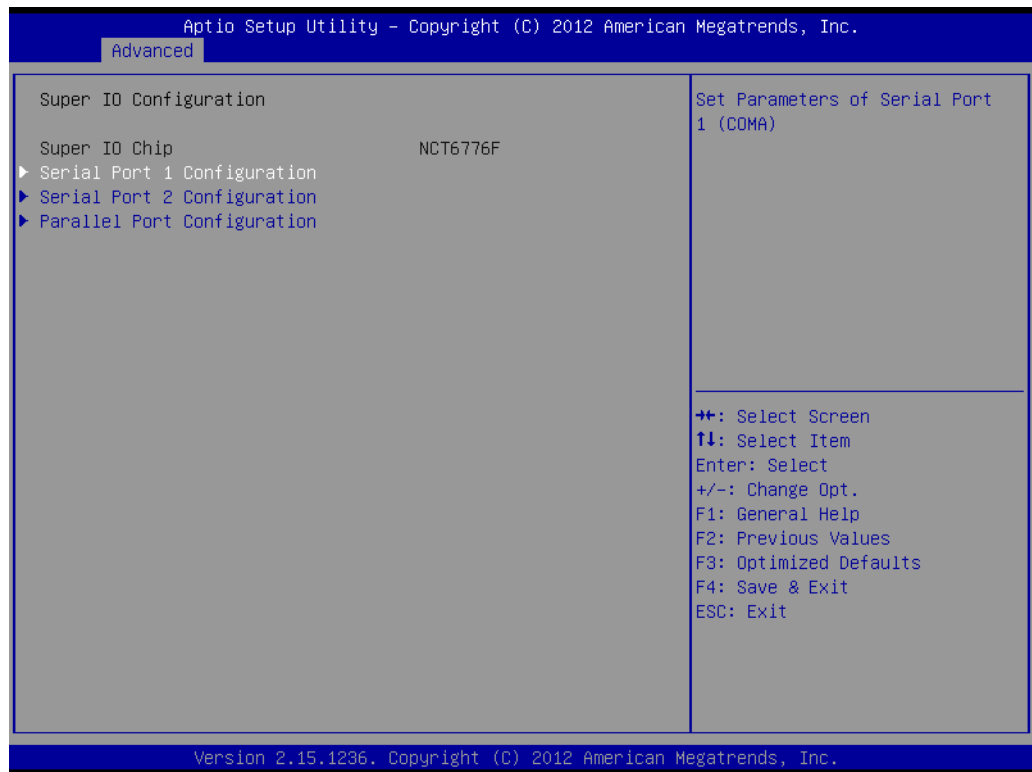

Figure 3.14 Super IO Configuration

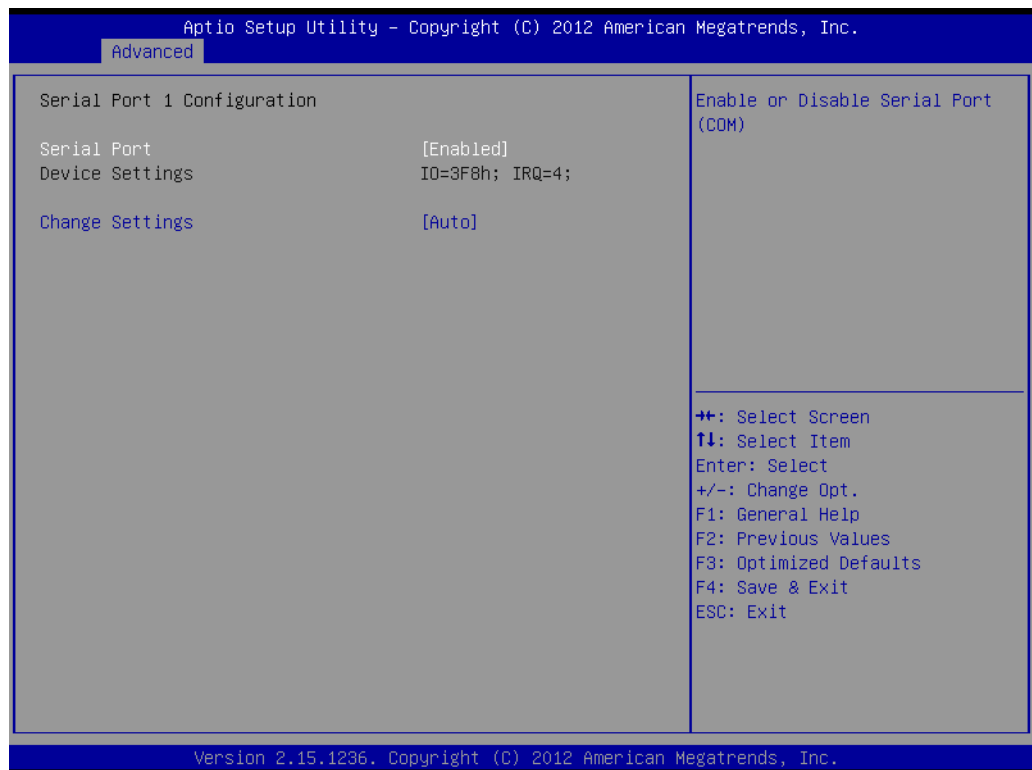

Figure 3.15 Serial Port 1 Configuration

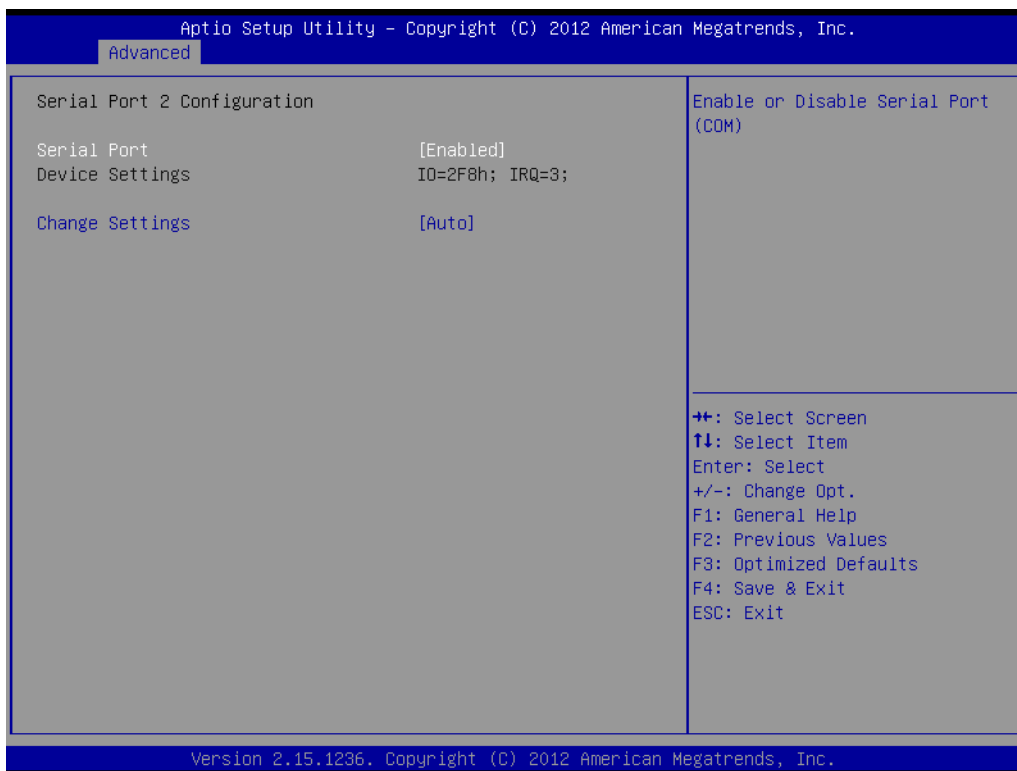

Figure 3.16 Serial Port 2 Configuration

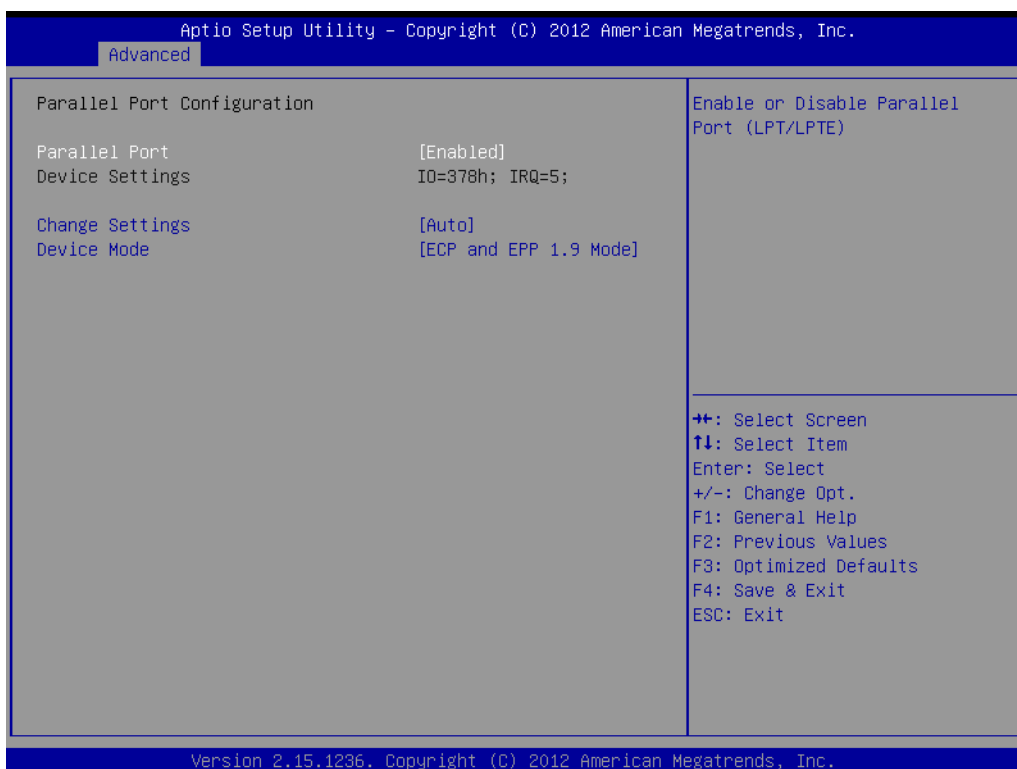

Figure 3.17 Parallel Configuration

Serial Port 1 Configuration

Serial Port

“Enable” or “disable” Serial Port 1.

Change Settings

Select optimal settings for serial port 1.

Serial Port 2 Configuration

Serial Port

“Enable” or “disable” serial port 2.

Change Settings

Select optimal settings for serial port 2.

Parallel Port

“Enable” or “disable” parallel port.

Change Settings

Select optimal settings for parallel port.

Device Mode

To change the printer port mode.

3.3.11 H/W Monitor

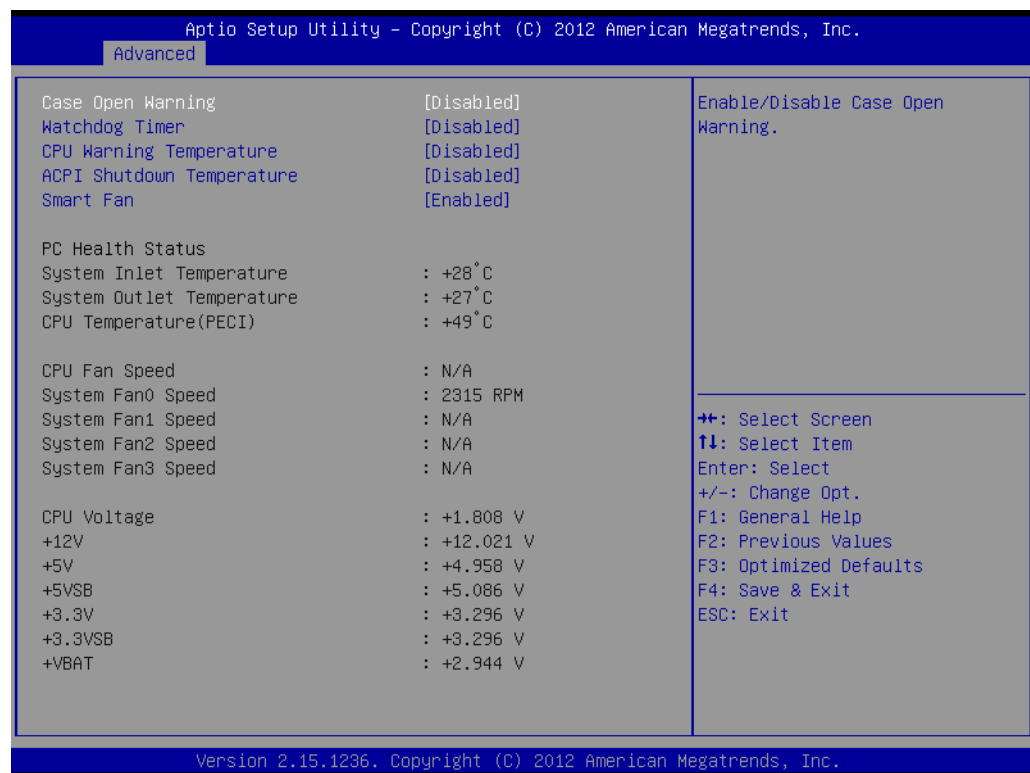

Figure 3.18 PC Health Status

CPU Temperature (PECI)

CPU temperature shown here is CPU T-junction temperature via PECI.

Case Open Warning

Enable/Disable the chassis Intrusion monitoring function. When enabled and the case is opened, a warning message will show in post screen.

CPU Warning Temperature

Use this to set the CPU warning temperature threshold. When the system reaches the warning temperature, the speaker will beep.

ACPI Shutdown Temperature

Use this to set the ACPI shutdown temperature threshold. When the system reaches the shutdown temperature, it will be automatically shut down by ACPI OS to protect the system from overheat damage.

Smart Fan

Enable or Disable CPU FAN and System FAN Mode to SMART FAN setting.

3.3.12 Serial Port Console Redirection

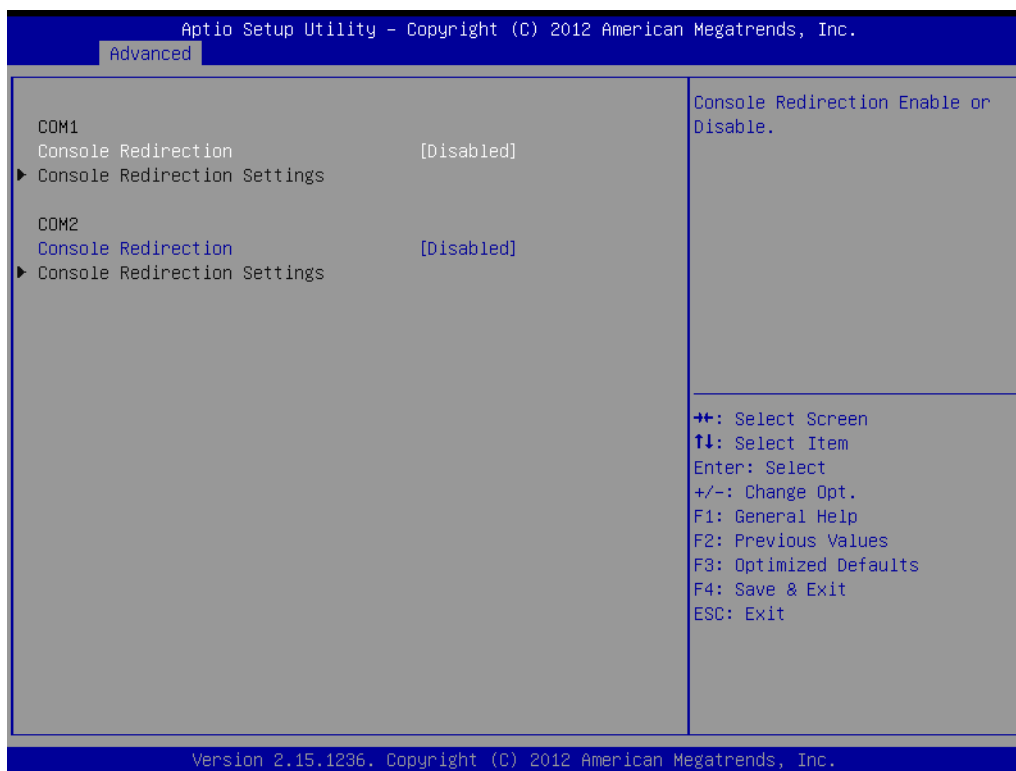

Figure 3.19 Serial Port Console Redirection

Console Redirection

Enable or disable the console redirection feature.

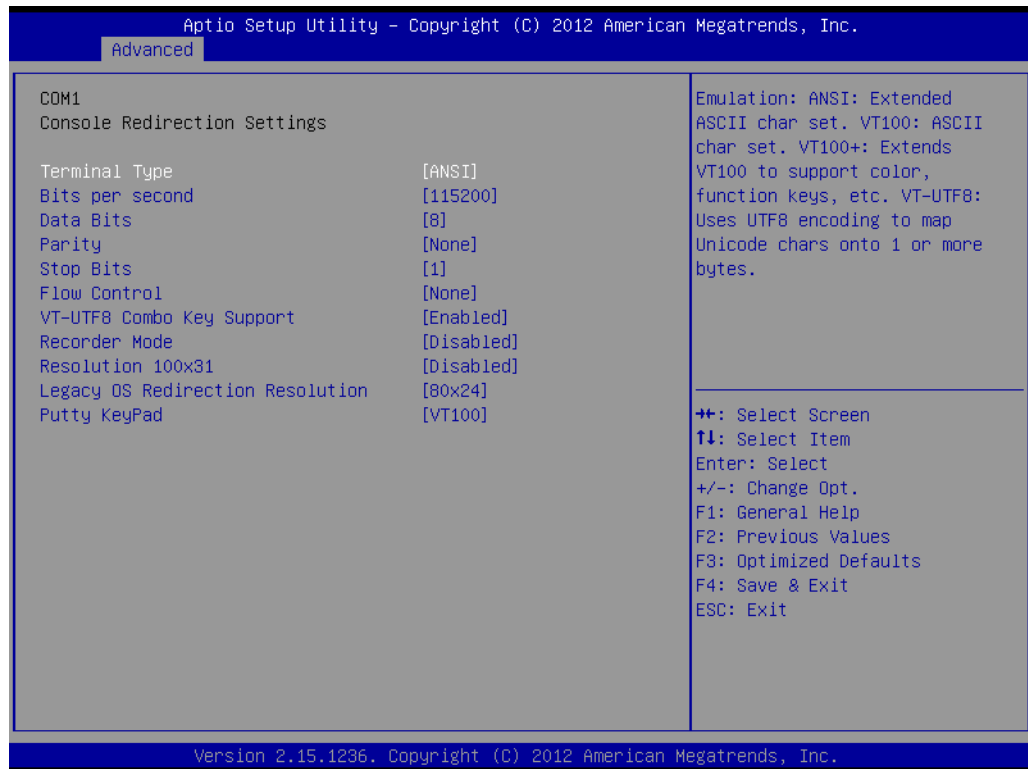

Figure 3.20 Console Redirection Setting

Terminal Type

Select a terminal type to be used for console redirection.

Options available: VT100/VT100+/ANSI /VT-UTF8.

Bits per second

Select the baud rate for console redirection.

Options available: 9600/19200/57600/115200.

Data Bits

This item is to set data bits between [8] or [7].

Parity

A parity bit can be sent with the data bits to detect some transmission errors.

Even: parity bit is 0 if the num of 1's in the data bits is even.

Odd: parity bit is 0 if num of 1's the data bits is odd.

Mark: parity bit is always 1. Space: Parity bit is always 0.

Mark and Space Parity do not allow for error detection.

Options available: None/Even/Odd/Mark/Space.

Stop Bits

Stop bits indicate the end of a serial data packet. (A start bit indicates the beginning). The standard setting is 1 stop bit. Communication with slow devices may require more than 1 stop bit.

Options available: 1/2.

Flow Control

Flow control can prevent data loss from buffer overflow. When sending data, if the receiving buffers are full, a 'stop' signal can be sent to stop the data flow. Once the buffers are empty, a 'start' signal can be sent to re-start the flow. Hardware flow control uses two wires to send start/stop signals.

Options available: None/Hardware RTS/CTS.

VT-UTF8 Combo Key Support

To enable VT-UTF8 combination key for supporting ANSI/VT100 terminals.

Recorder Mode

When this mode enabled, only text will be send. This is to capture Terminal data.

Options available: Enabled/Disabled.

Resolution 100x31

Enables or disables extended terminal resolution.

Options available: Enabled/Disabled.

Legacy OS Redirection Resolution

On Legacy OS, the number of Rows and Columns supported redirection.

Options available: 80x24/80X25.

Putty Keypad

To support selection function key and keypad on Putty.

3.4 Chipset

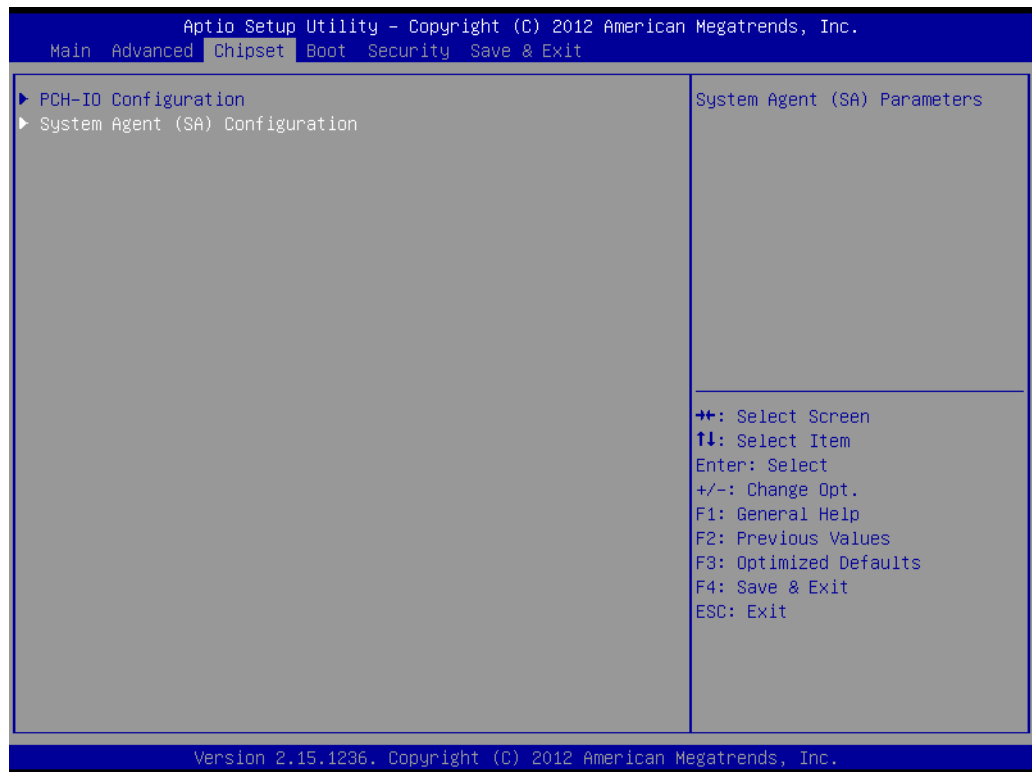

Figure 3.21 Chipset

3.4.1 PCH-IO Configuration

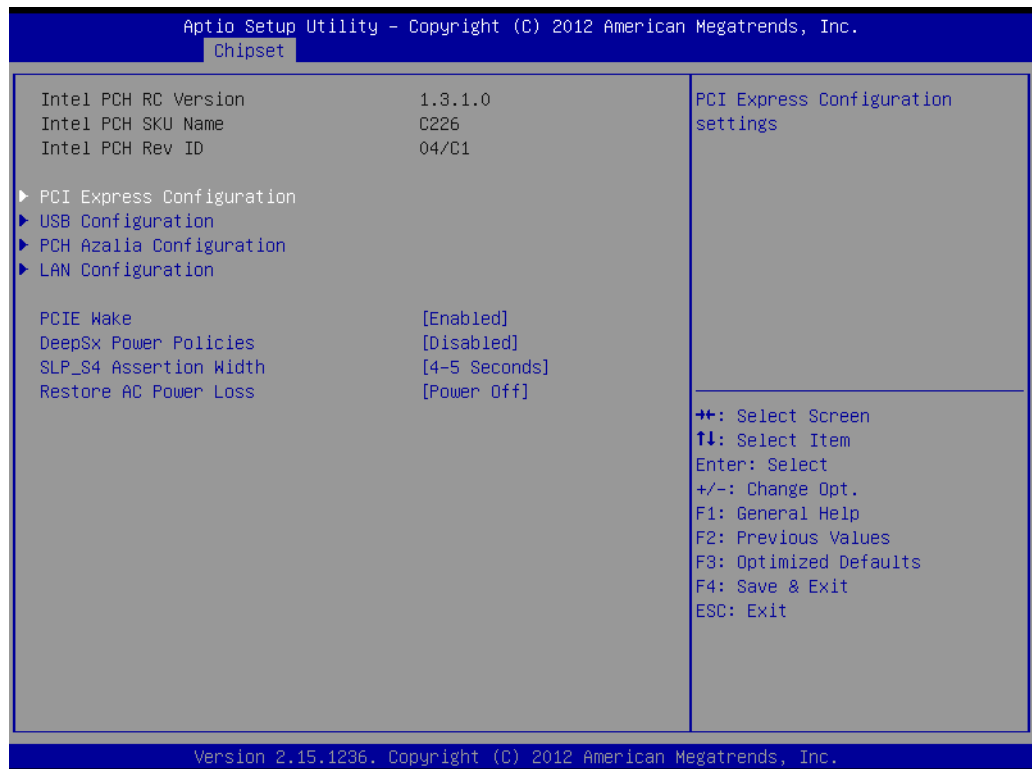

Figure 3.22 PCH-IO Configuration

PCIe Wake

To enable or disable PCIe to wake the system from S5.

Deep Sx Power Policies

Enable or disable Deep Sx feature. When Deep Sx is enabled, most power including 5VSB will be off during deep Sx for energy saving.

SLP_S4 Assertion Width

To select a minimum assertion width of the SLP_S4 signal.

Restore AC Power Loss

To select AC power state when power is re-applied after a power failure.

Note! *When a system enters G3 status with deep S5 enabled, some power supply's 5VSB won't drop until after more than 30 seconds. If "Restore AC Power Loss" is set to "power on", the system won't boot up in 30 seconds after power failure. We recommend the user waits for more than 30 seconds to power on after a power failure. On the other hand, the system will auto power on if power is restored within 30 seconds, before 5VSB actually drops, even if "Restore AC Power Loss" is set to "power off".*

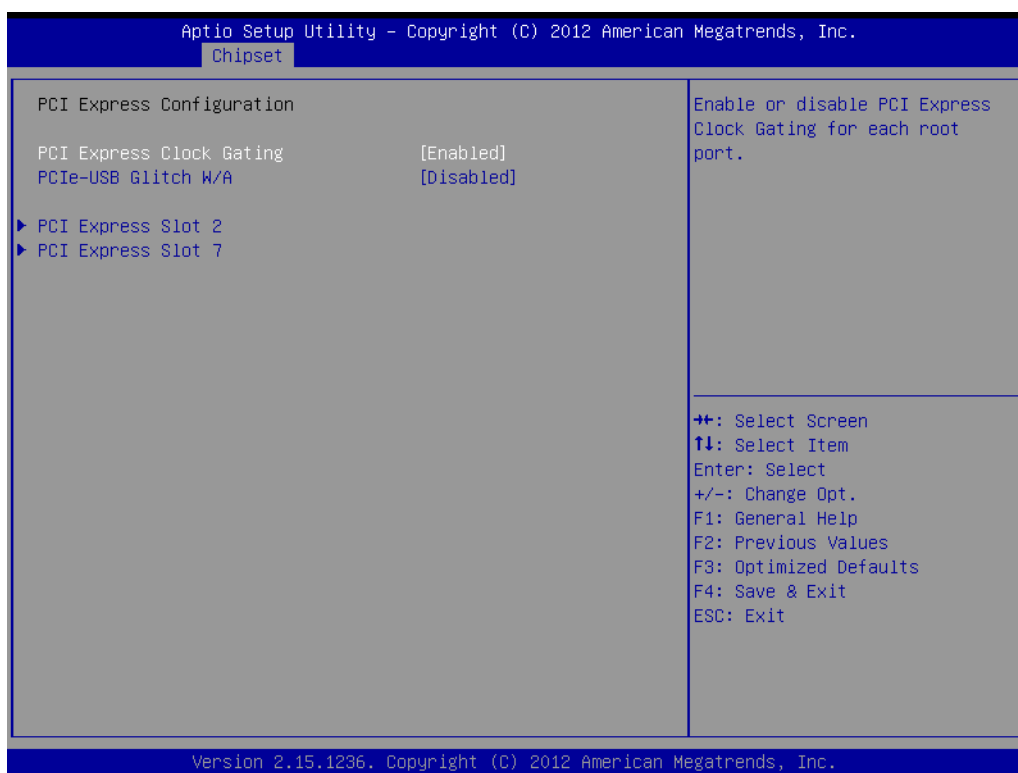

Figure 3.23 PCI Express Configuration

PCI Express Clock Gating

Enable or disable PCIe clock gating for each root port.

PCIe-USB Glitch W/A

Enable or disable PCIe-USB Glitch W/A for bad USB device(s) connected behind PCIe/PEG port.

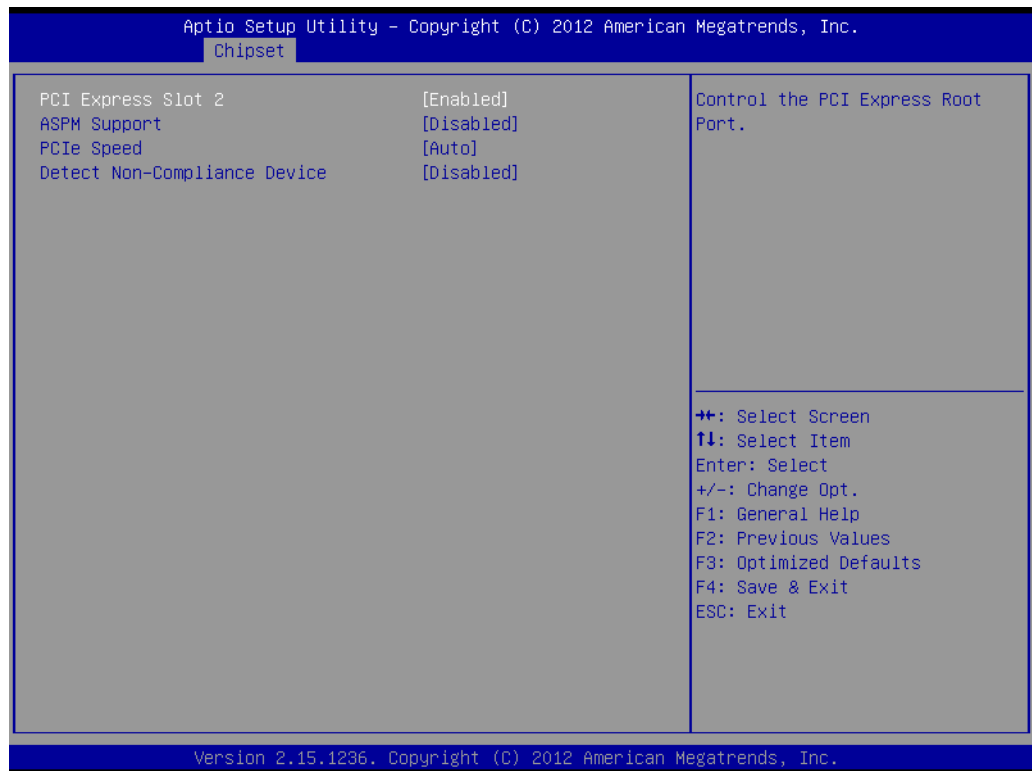

Figure 3.24 PCI Express Slot 2 Configuration

PCI Express Slot 2

To enable or disable PCI Express Slot 2.

ASPM Support

To set ASPM level for PCI Express Slot 2.

PCIe Speed

To set PCIe speed for PCI Express Slot 2.

Detect Non-Compliance Device

Detect Non-compliance PCIE device. When this item is enabled, it will take more time during POST.

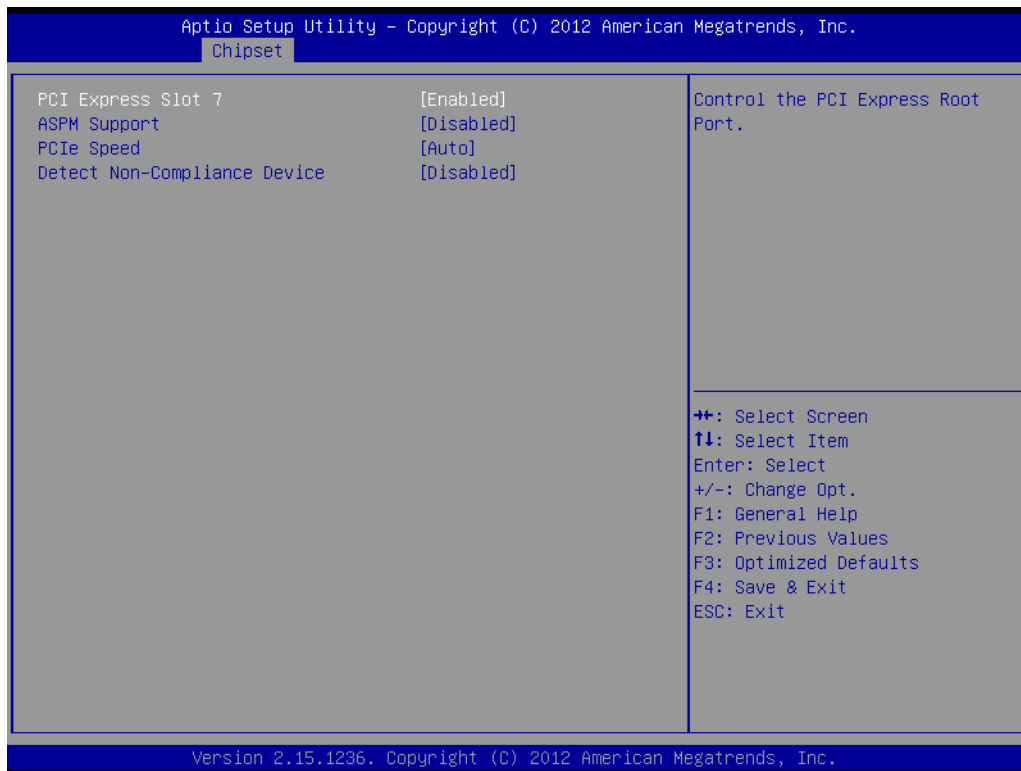

Figure 3.25 PCI Express Slot 7 Configuration

PCI Express Slot 7

To enable or disable PCI Express Slot 7.

ASPM Support

To set ASPM level for PCI Express Slot 7.

PCIe Speed

To set PCIe speed for PCI Express Slot 7.

Detect Non-Compliance Device

Detect Non-compliance PCIE device. When this item is enabled, it will take more time during POST.

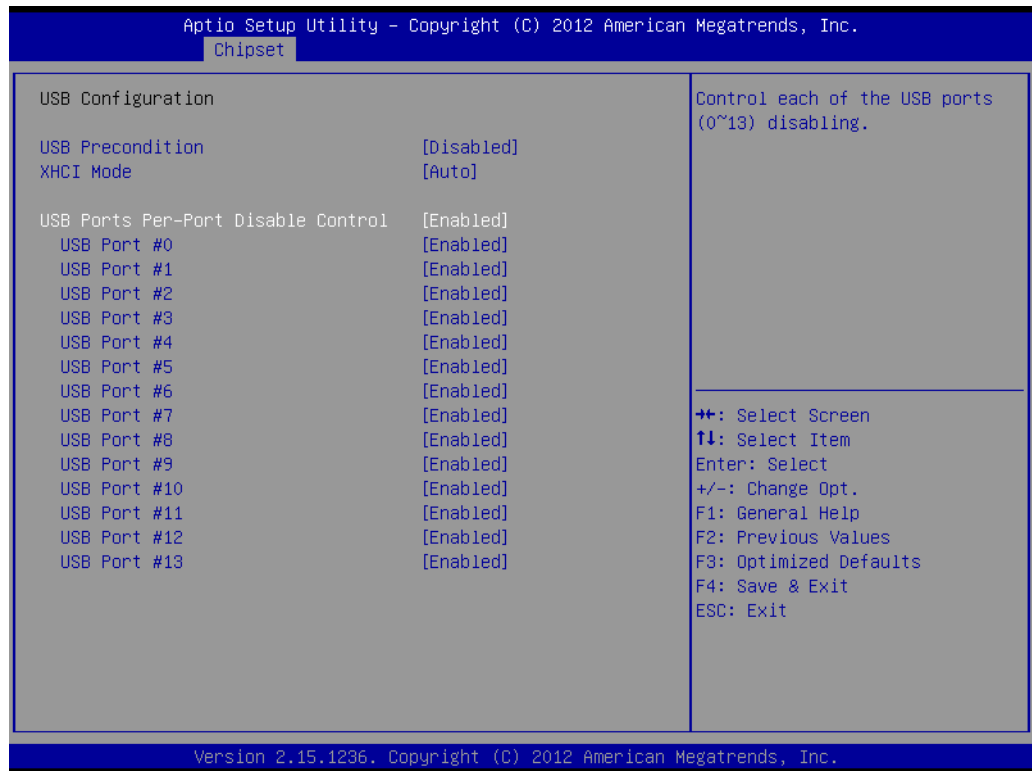

Figure 3.26 USB Configuration

USB Precondition

Pre-condition work on USB host controller and root ports for faster enumeration.

XHCI Mode

Mode of operation of XHCI controller.

USB Ports Pre-Port Disable Control

Enable or disable USB port#0~13.

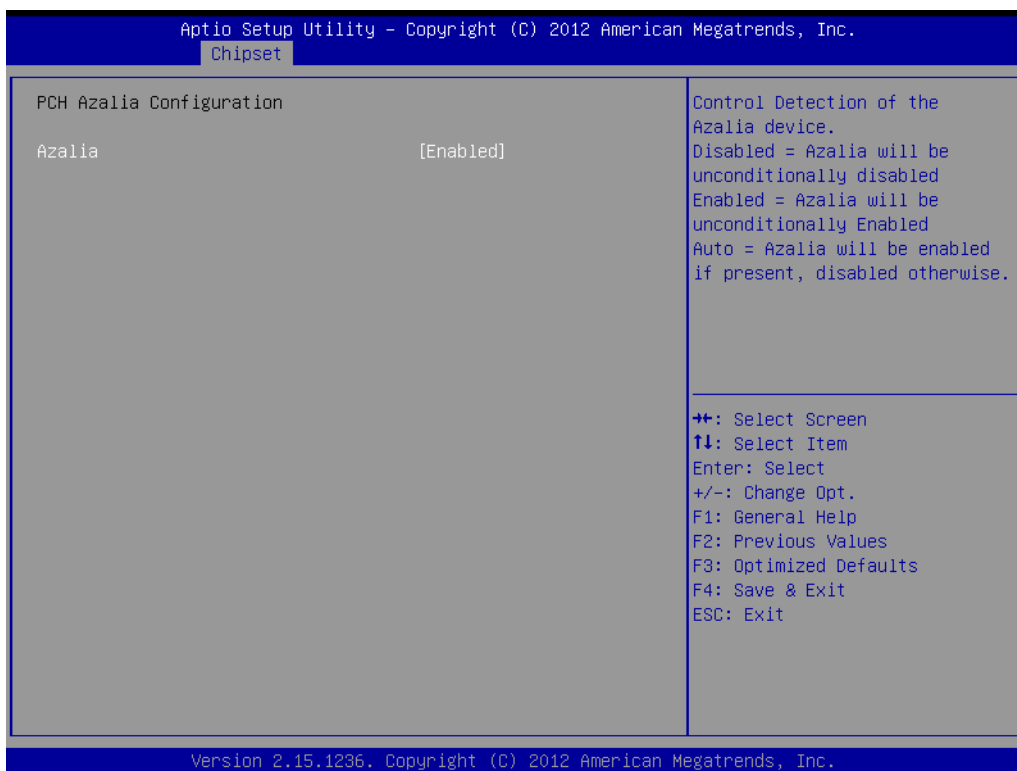

Figure 3.27 PCH Azalia

Azalia

Control detection of Azalia device.

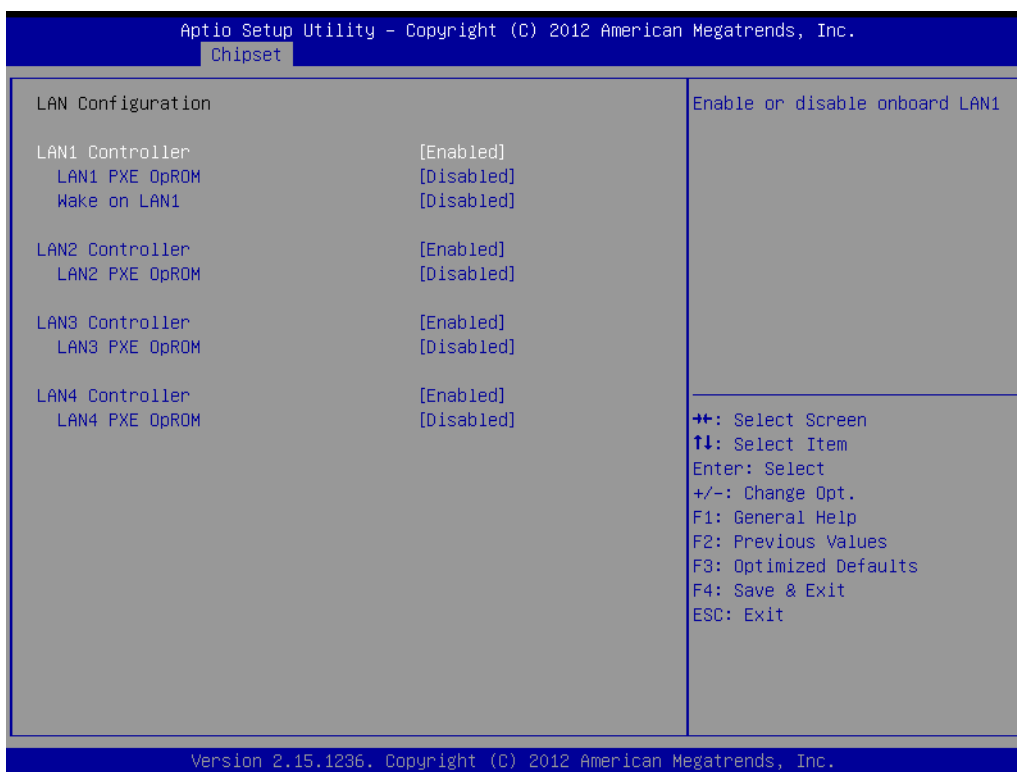

Figure 3.28 LAN Configuration

LAN1/LAN2/LAN3/LAN4 Controller

Enable or disable onboard LAN1/LAN2/LAN3/LAN4.

LAN1/LAN2/LAN3/LAN4 PXE OpROM

Enable or disable boot options for legacy network devices.

Wake on LAN1

Enable or disable integrated LAN to wake the system.

3.4.2 System Agent (SA) Configuration

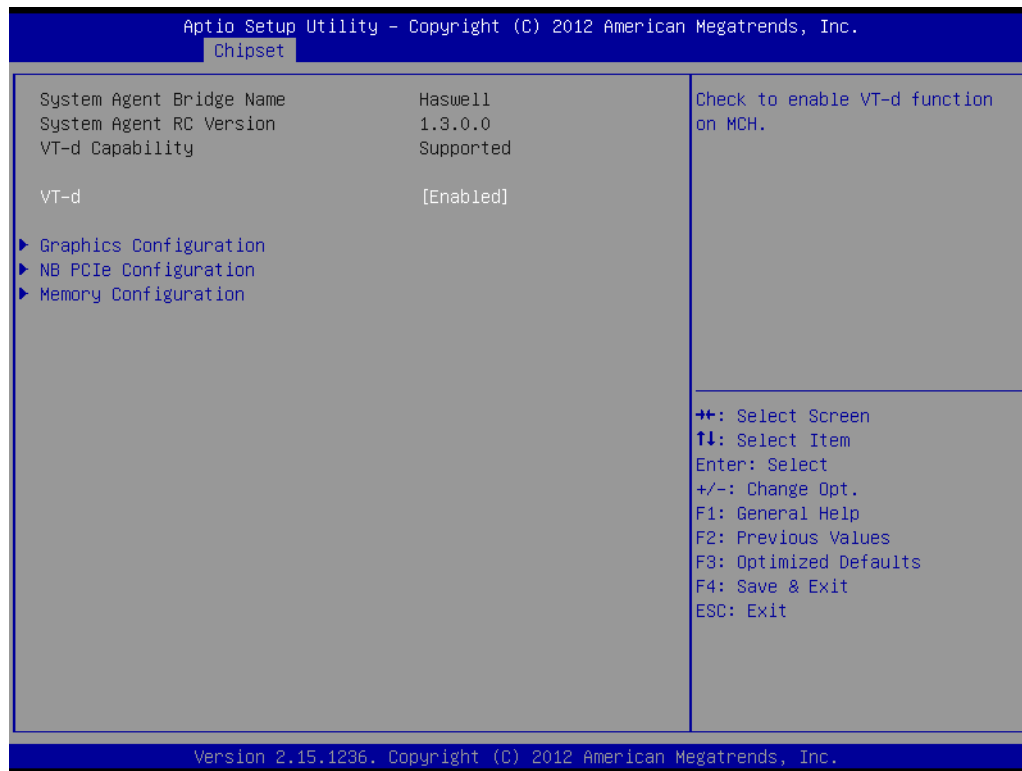

Figure 3.29 System Agent (SA) Configuration

VT-d

To enable or disable VT-d function on MCH.

3.4.2.1 Graphics Configuration

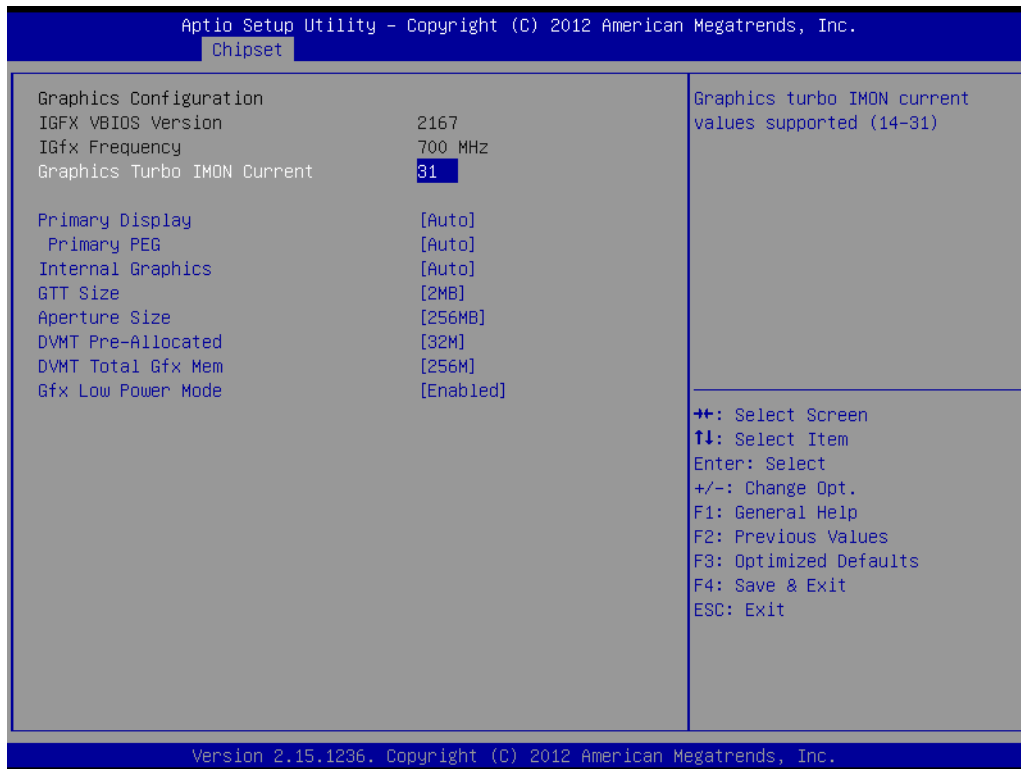

Figure 3.30 Graphics Configuration

Primary Display

To select which graphics device, IGFX/PEG/PCI should be primary display or select SG for switchable Gfx.

Primary PEG

Select which PEG port as a primary PEG when primary PEG is set as [PEG] or [PCIE].

Internal Graphics

To enable/disable/Auto internal graphics.

GTT Size

This item sets the amount of main memory that is pre-allocated to support the Internal Graphics Translation Table.

Aperture Size

This item is to determine the size of the graphics memory aperture in function 0 and in the trusted space.

DVMT Pre-Allocated

This item is to select DVMT 5.0 Pre-Allocated (Fixed) Graphics Memory size used by the Internal Graphics Device.

DVMT Total Gfx Mem

This item is to select DVMT5.0 Total Graphic Memory size used by the Internal Graphics Device.

Gfx Low Power Mode

This option is applicable for SFF only

3.4.2.2 NB PCIe Configuration

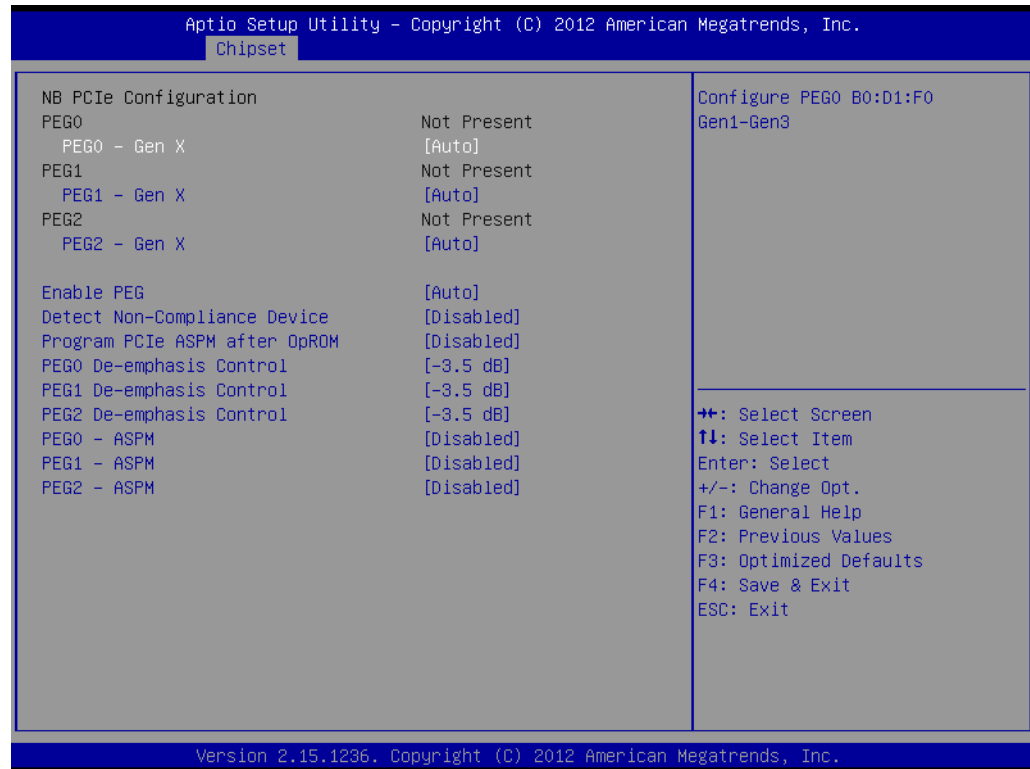

Figure 3.31 NB PCIe Configuration

PEG0~2 - Genx

To configure PEG0~2 as Gen1, Gen2 or Gen3.

Enable PEG

To enable or disable the PEG.

Detect Non-Compliance Device

Detect Non-compliance PCIE device in PEG.

Program PCIe ASPM after OpROM

[Enable]: PCIe ASPM will be programmed after OpROM. [Disable]: PCIe ASPM will be programmed before OpROM.

PEG0~2 De-emphasis Control

Configure the De-emphasis control on PEG0~2.

PEG0~2 ASPM

To control ASPM support for the PEG Device, and this item has no effect if PEG is not the currently active device.

3.4.2.3 Memory Configuration



Figure 3.32 Memory Configuration

Memory Frequency Limiter

To set the maximum memory frequency between [1067],[1333] and [1600].

3.5 Boot

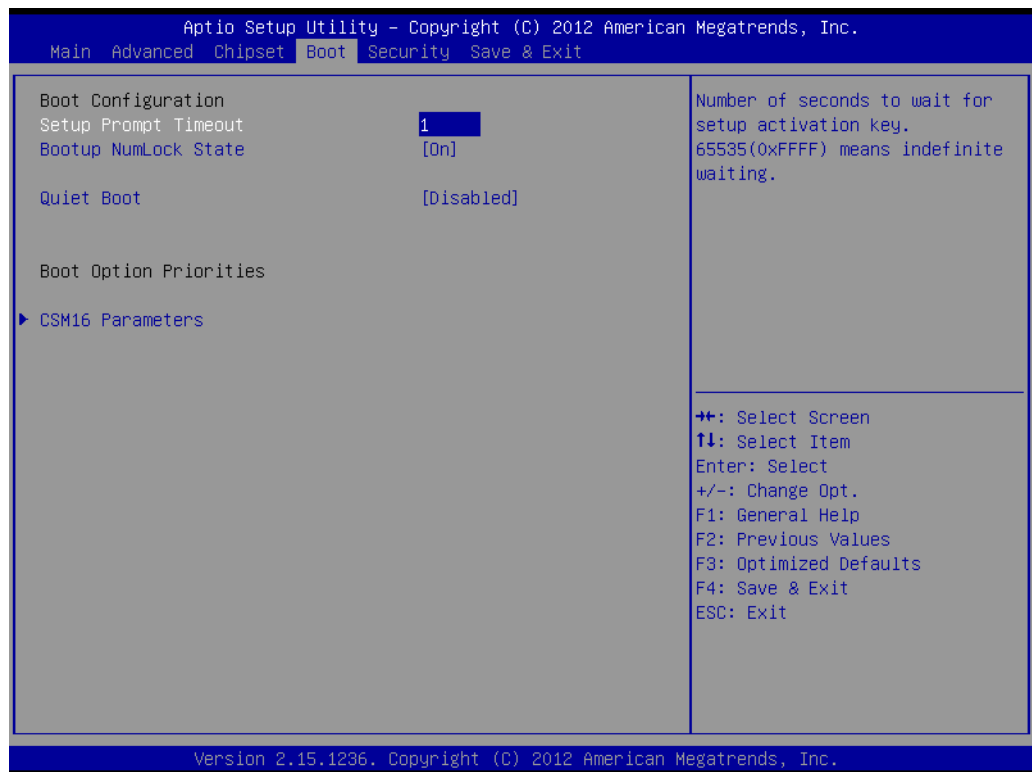

Figure 3.33 Boot

Setup Prompt Timeout

Use the <+> and <-> keys to adjust the number of seconds to wait for setup activation key.

Bootup NumLock State

“On” or “Off” power-on state for the NumLock

Quiet Boot

If this option is set to Disabled, the BIOS displays normal POST messages. If Enabled, an OEM Logo is shown instead of POST messages.

Boot Option Priorities

Choose boot priority from boot device.



Figure 3.34 CSM16 Parameters

GateA20 Active

This item is useful when RT code is executed above 1MB. When this is set as "UPON REQUEST", GA20 can be disabled using BIOS services. When it's set as "Always", it does not allow disabling GA20.

Option ROM Messages

"Force BIOS or Keep Current" to set the display mode for Option ROM

INT19 Trap Response

This item is a BIOS reaction on INT19 trapping by Option ROM. When it's set as "Immediate", the trap will be executed right away. When it's set as "Postponed", the trap will be executed during legacy boot.

3.6 Security

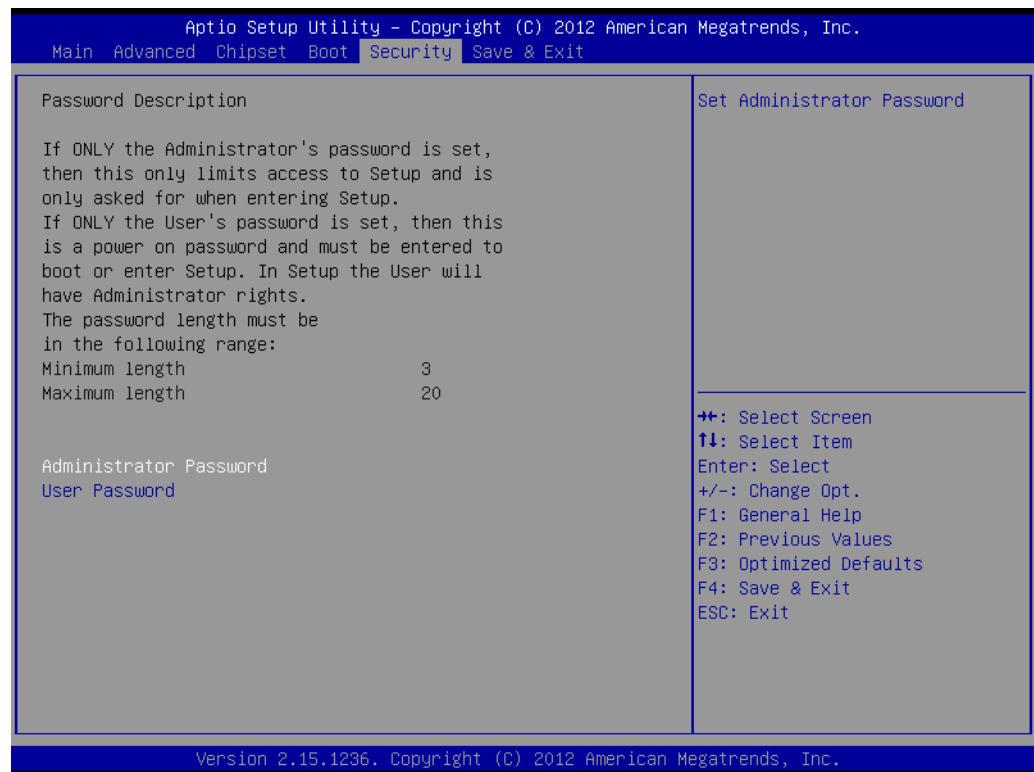

Figure 3.35 Security

Select Security Setup from the ASMB-784 Setup main BIOS setup menu. All Security Setup options, such as password protection, are described in this section. To access the sub menu for the following items, select the item and press <Enter>.

3.7 Save & Exit

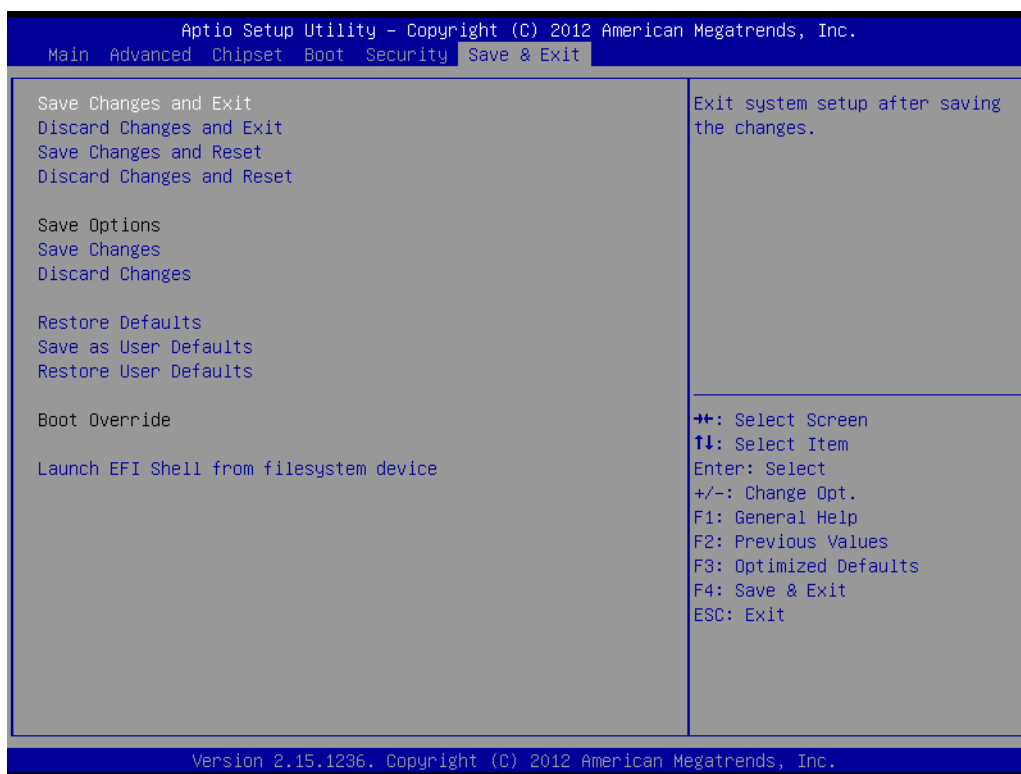

Figure 3.36 Save & Exit

Save changes and exit*

When you have completed system configuration, select this option to save your changes, exit BIOS setup and boot into the OS so the new system configuration parameters can take effect.

Discard changes and exit

Select this option to quit setup without making any permanent changes to the system configuration.

Save changes and Reset

When you have completed system configuration, select this option to save your changes, exit BIOS setup and reboot into the computer so the new system configuration parameters can take effect.

Discard changes and Reset

Select this option to quit Setup and reset computer without making any permanent changes to the system configuration.

Save Changes

Select this option to save your changes.

Discard Changes

Select this option to discard your changes.

Restore Defaults

Select this option to restore BIOS configuration as origin.

Save as User Defaults

Select this option to save user's configuration.

Restore User Defaults

Select this option to restore BIOS to user's configuration.

Launch EFI Shell from file system device

This option allows you to attempt to launch the EFI Shell application (shellx64.efi) from one of the available file system devices.

*When you do some critical changes, the system will still reboot even you choose "Save changes and exit".

3.8 Server Management

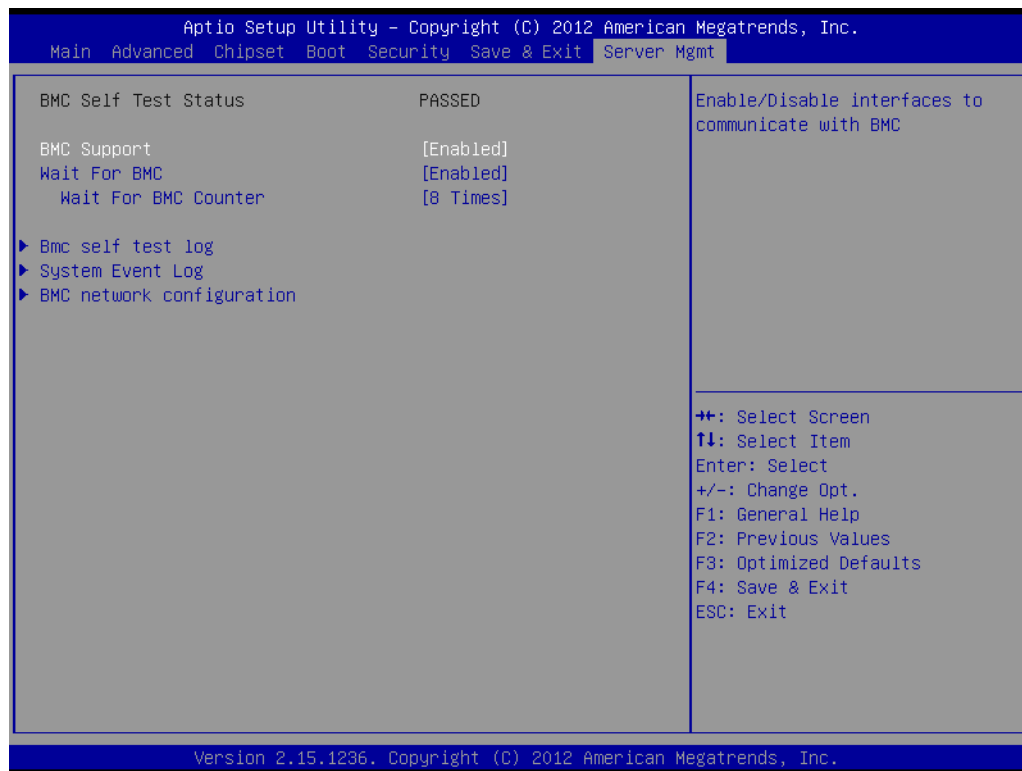

Figure 3.37 Server Management

BMC Support

Enable/Disable interfaces to communicate with BMC (IPMI-1000 module).

Wait for BMC

If enabled, the motherboard will wait 60 seconds until BMC (IPMI-1000 Module) boots up completely, after which a normal BIOS post screen will be displayed. If disabled, the motherboard will not wait for the BMC's (IPMI-1000 Module) response.

3.8.1 BMC Self Test Log

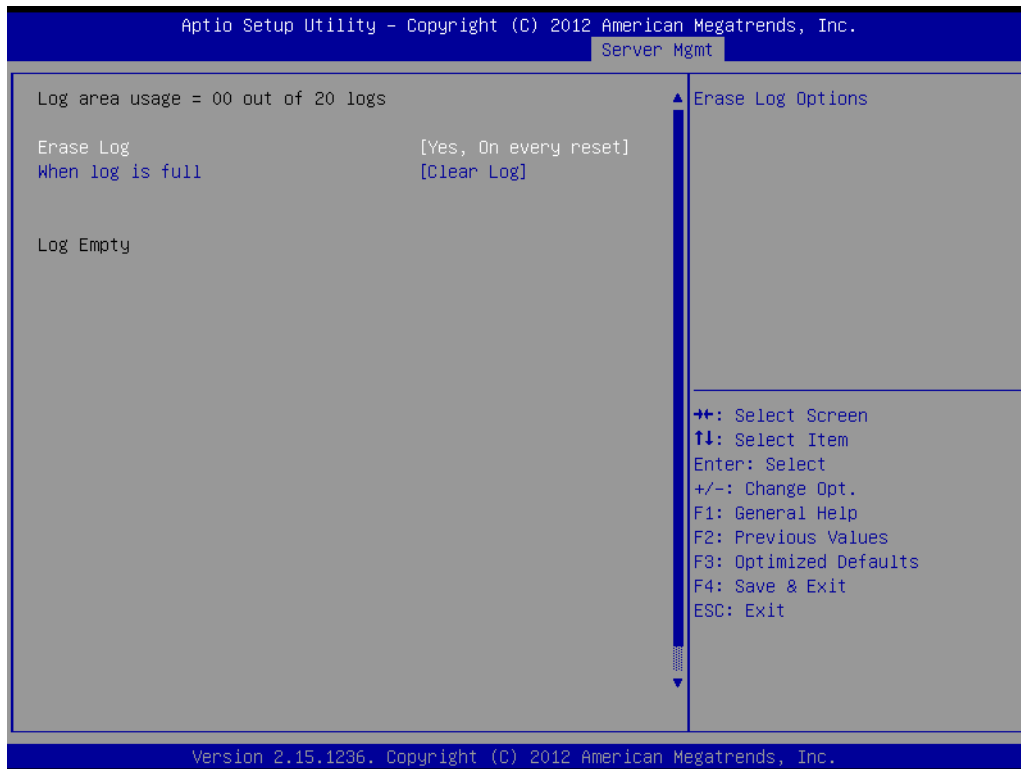

Figure 3.38 BMC Self Test Log

Erase Log

Erase log options

When Log is Full

Select the action to be taken when log is full

3.8.2 System Event Log

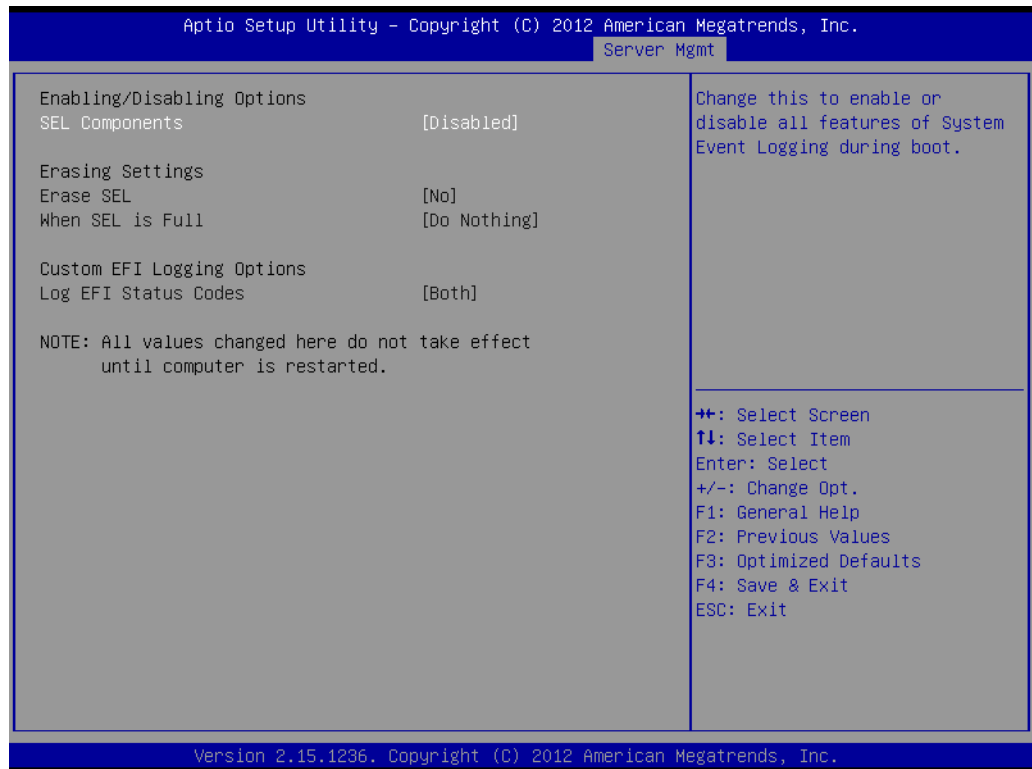

Figure 3.39 System Event Log

SEL Components

Enable/Disable all features of system event logging during boot

Erase SEL

Choose options for erasing SEL

When SEL is Full

Choose options for reactions to a full SEL

Log EFI Status Codes

Disable the logging of EFI status codes or log only error code or only progress code or both

3.8.3 BMC Network Configuration

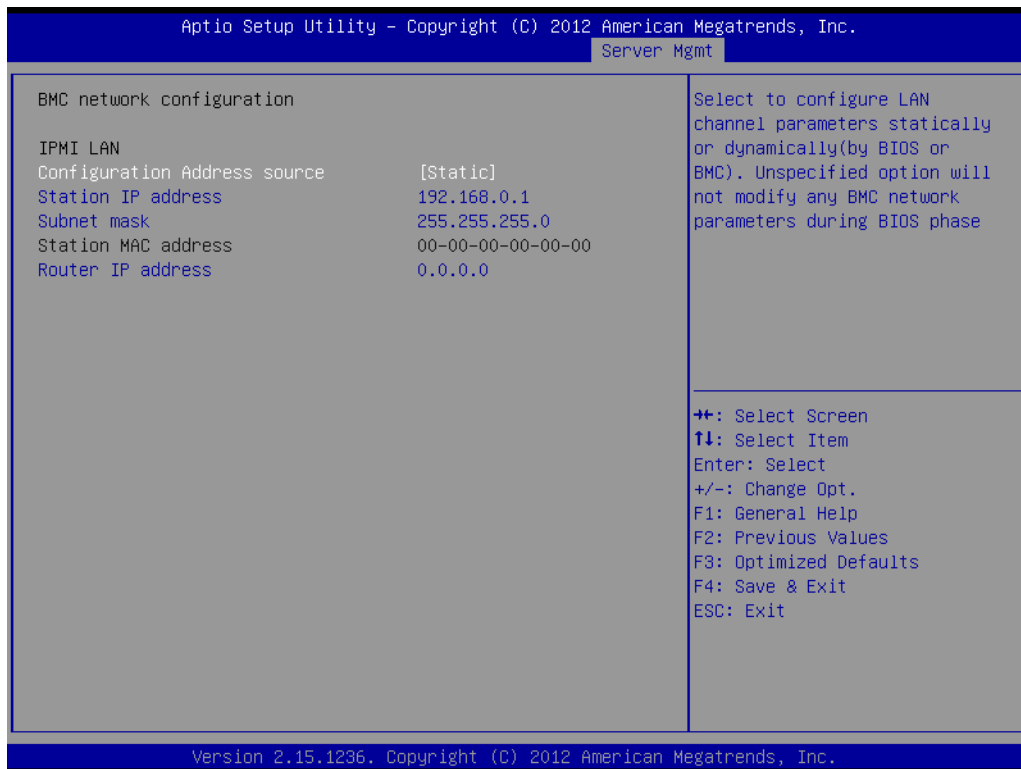

Figure 3.40 BMC network configuration

Configuration Address Source

Select to configure LAN channel parameters statically or dynamically (by BMC /IPMI-1000 module). Unspecified will not modify any BMC (IPMI-1000 module) network parameters during BIOS posting phase.

Chapter 4

Chipset Software
Installation Utility

4.1 Before You Begin

To facilitate the installation of the enhanced display drivers and utility software, read the instructions in this chapter carefully. The drivers for the ASMB-784 are located on the software installation CD.

Note! *The files on the software installation CD are compressed. Do not attempt to install the drivers by copying the files manually. You must use the supplied SETUP program to install the drivers.*



Before you begin, it is important to note that most display drivers need to have the relevant software application already installed in the system prior to installing the enhanced display drivers. In addition, many of the installation procedures assume that you are familiar with both the relevant software applications and operating system commands. Review the relevant operating system commands and the pertinent sections of your application software's user manual before performing the installation.

4.2 Introduction

The Intel® Chipset Software Installation (CSI) utility installs the Windows INF files that outline to the operating system how the chipset components will be configured. This is needed for the proper functioning of the following features:

- Serial ATA interface support
- USB 1.1/2.0 support (USB 2.0 driver needs to be installed separately for Windows 98)
- USB 3.0 driver support is for Windows 7 and 2008 only. Under the other Windows OS (for example XP or 2003), USB 3.0 port will be operated at USB 2.0 speed.
- Identification of Intel chipset components in the Device Manager

Note! *The chipset driver is used for the following versions of Windows, and it has to be installed before installing all the other drivers:*



- Windows® server 2008 R2 (64-bit)
- Windows® server 2012 (64-bit)
- Windows® 7 SP1 (32-bit)
- Windows® 7 SP1 (64-bit)
- Windows® 8 Pro (32-bit)
- Windows® 8 Pro (64-bit)

4.3 Windows OS Driver Setup

Insert the driver CD into your system's CD-ROM drive. You can see the driver folders items. Move the mouse cursor over the folder "01-Chipset". In CSI folder, you can click find an executable file to complete implementation of the driver.

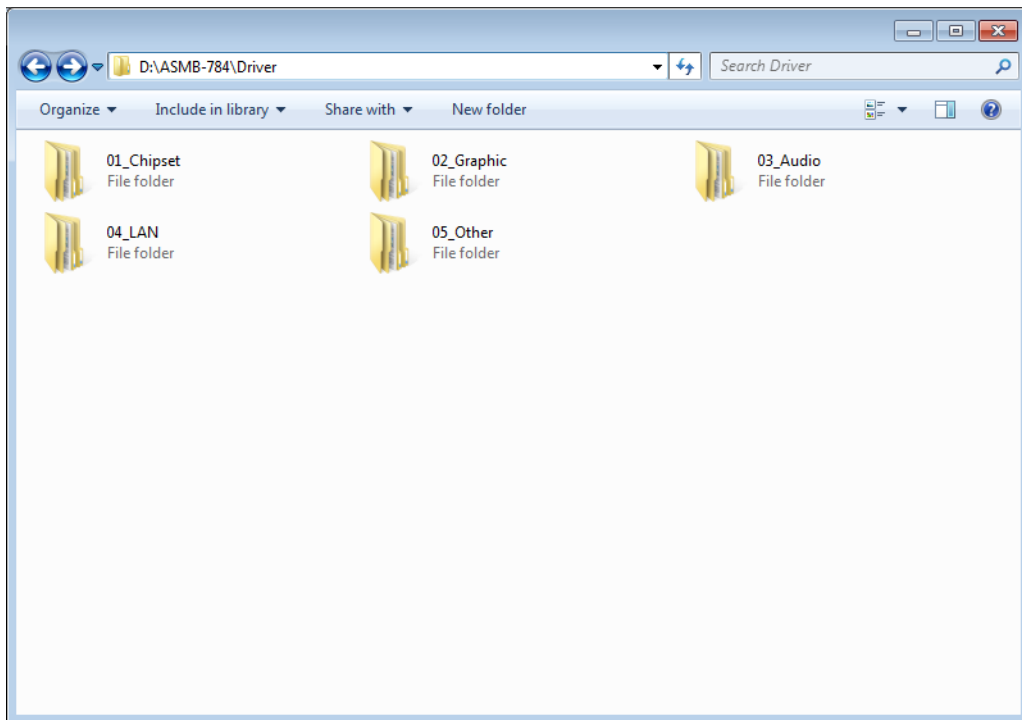

Chapter 5

VGA Setup

5.1 Introduction

The Intel® Core™ i processors are embedded with integrated graphics controller. You need to install the VGA driver to enable this function, which includes the following features:

- Optimized integrated graphic solution: With Intel® Graphics Flexible Display Interface, it supports versatile display options and 32-bit 3D graphics engine. Dual independent display, enhanced display modes for widescreen flat panels for extend, twin, and clone dual display mode, and optimized 3D support deliver an intensive and realistic visual experience.

5.2 Windows OS Driver Setup

Note! Before installing this driver, make sure the INF driver has been installed in your system. See Chapter 4 for information on installing the INF driver.



Insert the driver CD into your system's CD-ROM drive. You can see the driver folders items. Navigate to the "02-HD Graphics" folder and click the executable file to complete the installation of the drivers for Windows® OS.

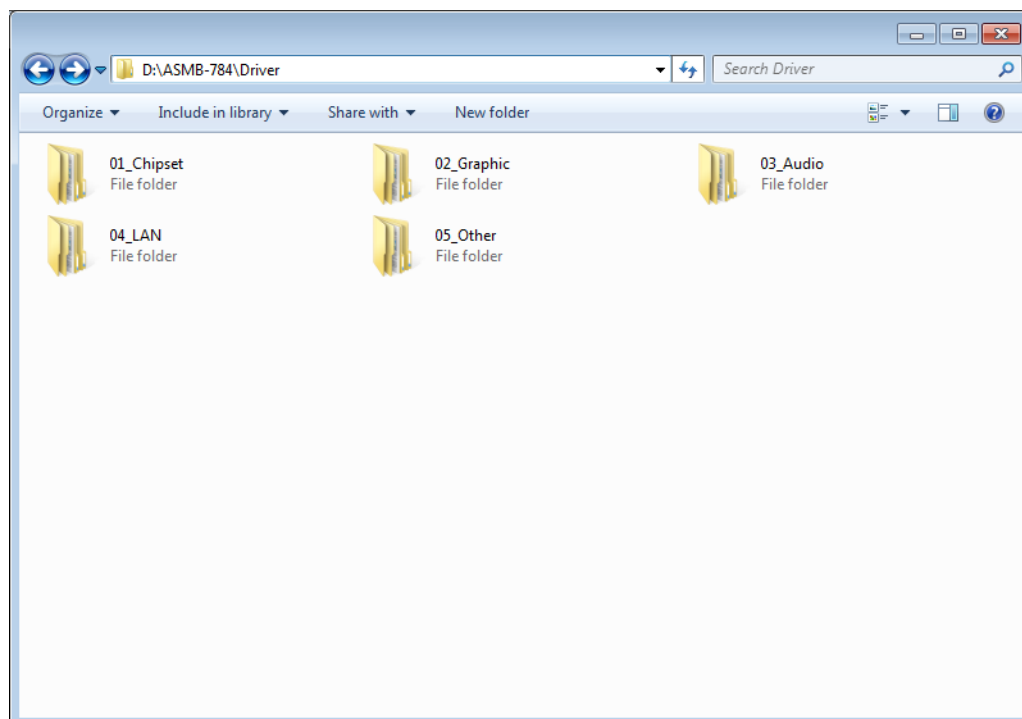

Chapter 6

LAN Configuration

6.1 Introduction

The ASMB-784 has two or four Gigabit Ethernet LANs via dedicated PCI Express x1 lanes (GbE LAN1: Intel I217LM; GbE LAN2/3/4: Intel I210-AT that offer bandwidth of up to 500 MB/sec, eliminating the bottleneck of network data flow and incorporating Gigabit Ethernet at 1000 Mbps.

6.2 Features

- 10/100/1000 Mbps Ethernet controller
- 10/100/1000 Mbps triple-speed MAC
- Full duplex at 10, 100, or 1000 Mbps and half duplex at 10 or 100 Mbps
- Wake-on-LAN (WOL) support
- PCIe x1 host interface

6.3 Installation

Note! Before installing the LAN drivers, make sure the CSI utility has been installed on your system. See Chapter 4 for information on installing the CSI utility.



The integrated Intel® gigabit Ethernet controller supports all major network operating systems. However, the installation procedure varies with different operating systems. In the following sections, refer to the one that provides the driver setup procedure for the operating system you are using.

6.4 Windows OS Driver Setup (LAN)

Insert the driver CD into your system's CD-ROM drive. Select folder "04-LAN" then click the proper LAN driver for the OS.

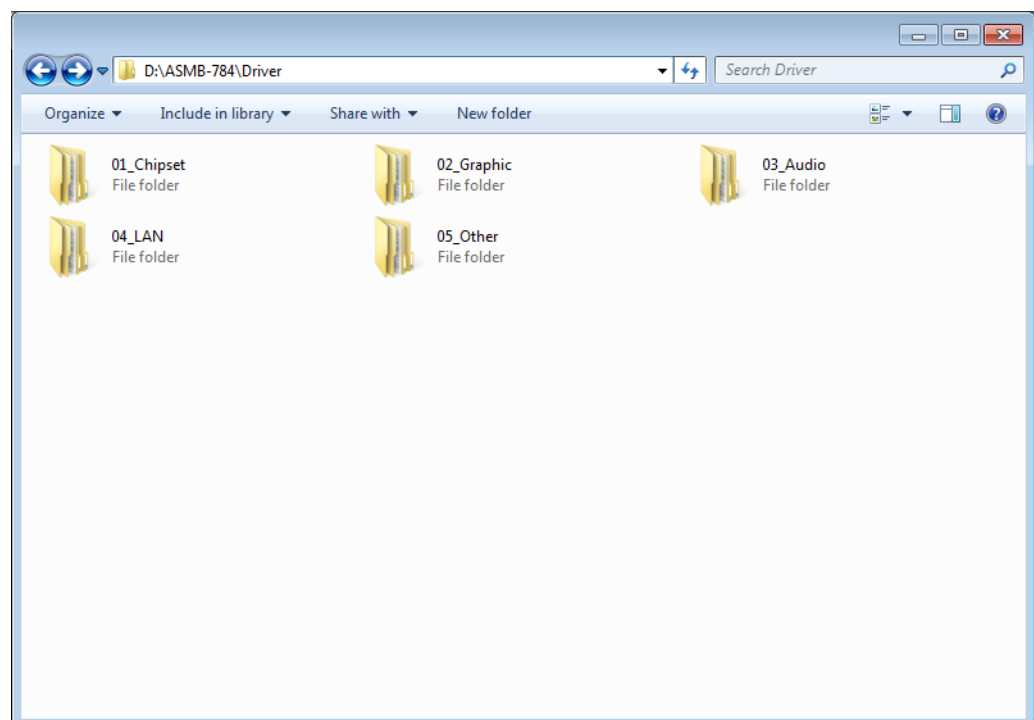

Chapter 7

Intel ME

7.1 Introduction

The Intel ME software components that need to be installed depend on the system's specific hardware and firmware features. The installer detects the system's capabilities and installs the relevant drivers and applications.

7.2 Installation

Insert the driver CD into your system's CD-ROM drive. Navigate to the "05. Other" folder and find folder "Intel ME" to install the driver.

Note! *If the Intel® Management Engine (Intel ME) driver has not been successfully installed, you may see an error on a "PCI Simple Communications Controller" in Device Manager.*



The integrated Intel® gigabit Ethernet controller supports all major network operating systems. However, the installation procedure varies with different operating systems. In the following sections, refer to the one that provides the driver setup procedure for the operating system you are using.

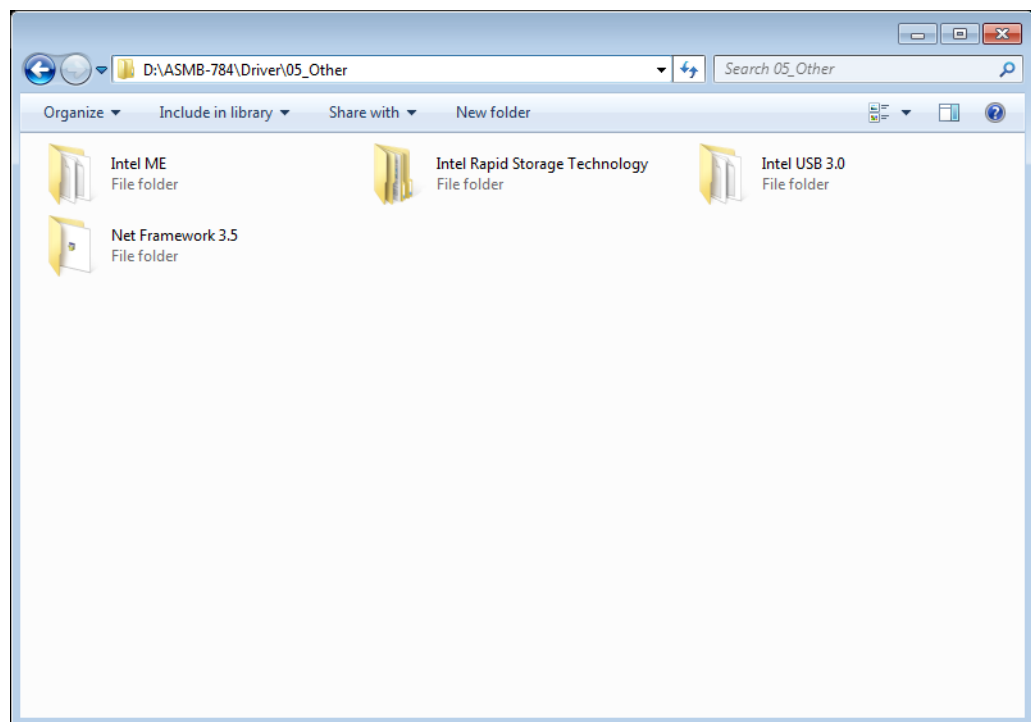

Chapter 8

Intel USB 3.0

8.1 Introduction

ASMB-784 provides Intel® USB 3.0 and the data transfer rate of USB 3.0 (5 Gbps) is 10 times to USB 2.0 (480Mbps).

8.2 Installation

Insert the driver CD into your system's CD-ROM drive. Navigate to the "05. Other" folder and find "Intel USB3.0" folder to install the driver.

Note! *The Intel® USB 3.0 eXtensible Host Controller Driver is not supported on Windows* XP and Windows* Vista. For these operating systems, ensure your BIOS settings have the xHCI Mode set to "Auto" or "Smart Auto". This will reconfigure the USB 3.0 ports to function as USB 2.0 ports using the native Windows* EHCI driver.*

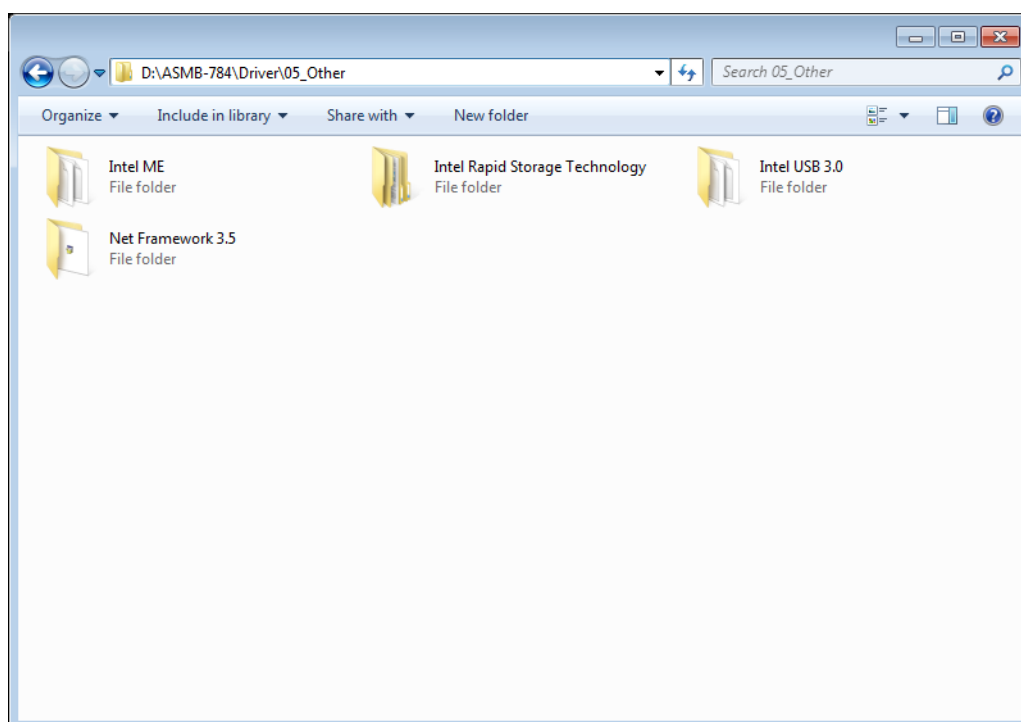

Chapter 9

SATA RAID Setup

9.1 Introduction

To support demanding disk I/O, Intel C226 chipset integrates six Serial ATA controllers with software RAID 0, 1, 5, 10 capabilities.

RAID 0 striping increases the storage performance and is designed to speed up data transfer rates for disk-intensive applications.

RAID 1 mirroring protects valuable data that might be lost in the event of a hard drive failure.

RAID 5 array contains three or more hard drives where the data is divided into manageable blocks called stripes. Parity is a mathematical method for recreating data that was lost from a single drive which increases fault-tolerance. The data and parity are striped across all the hard drives in the array. The parity is striped in a rotating sequence to reduce bottlenecks associated with the parity calculations.

RAID 10 array uses four hard drives to create a combination of RAID levels 0 and 1. The data is striped across a two-drive array forming the RAID 0 component. Each of the drives in the RAID 0 array is then mirrored by a RAID 1 component.

9.2 SATA RAID Driver and Utility Setup

The driver is in the CD's "05. Other" folder. You may go to the directory of the CD and follow Intel's installation guide to install the driver and utility.

Note! *For the detailed installation instructions for the SATA RAID driver and utility, please check the User Guide in the driver CD. Path: folder "Intel Rapid Storage Technology" in "05. Other".*



Note! *Before you install the Intel Rapid Storage Technology, please read the "readme.txt" which is in the folder "Intel Rapid Storage Technology" in "05-Other".*

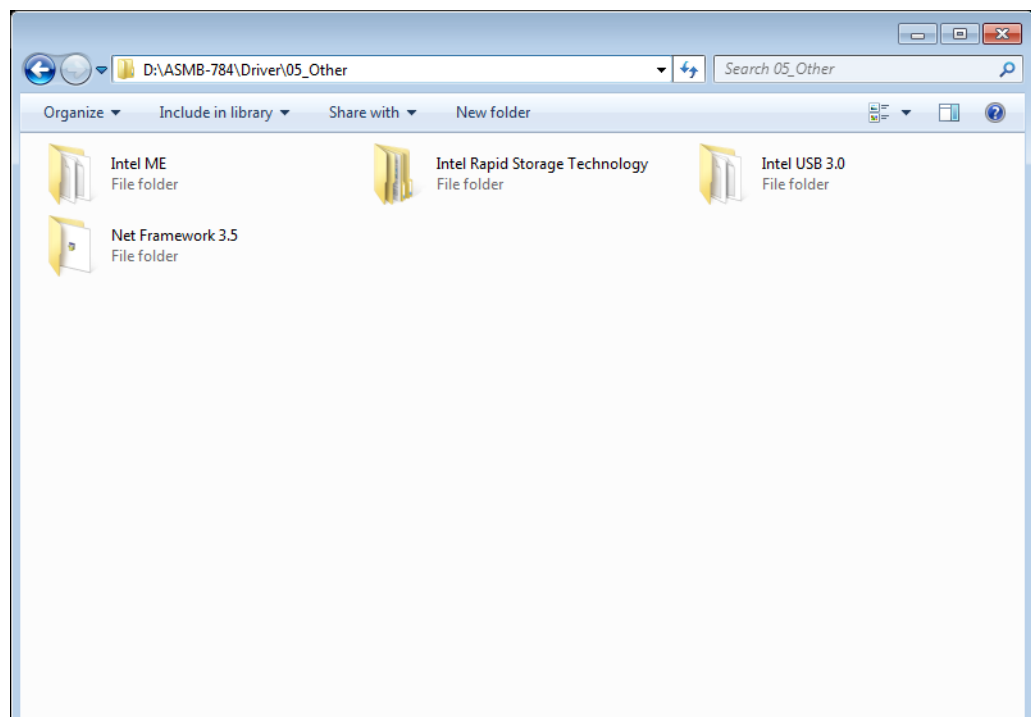

Appendix **A**

Programming the
Watchdog Timer

The ASMB-784's watchdog timer can be used to monitor system software operation and take corrective action if the software fails to function within the programmed period. This section describes the operation of the watchdog timer and how to program it.

A.1 Watchdog timer overview

The watchdog timer is built in to the super I/O controller NCT6776F. It provides the following functions for user programming:

- Can be enabled and disabled by user's program
- Timer can be set from 1 to 255 seconds
- Generates an interrupt or resets signal if the software fails to reset the timer before time-out

A.2 Programming the Watchdog Timer

The I/O port address of the watchdog timer is 2E (hex) and 2F (hex). 2E (hex) is the address port. 2F (hex) is the data port. You must first write an address value into address port 2E (hex), and then write/read data to/from the assigned register through data port 2F (hex).

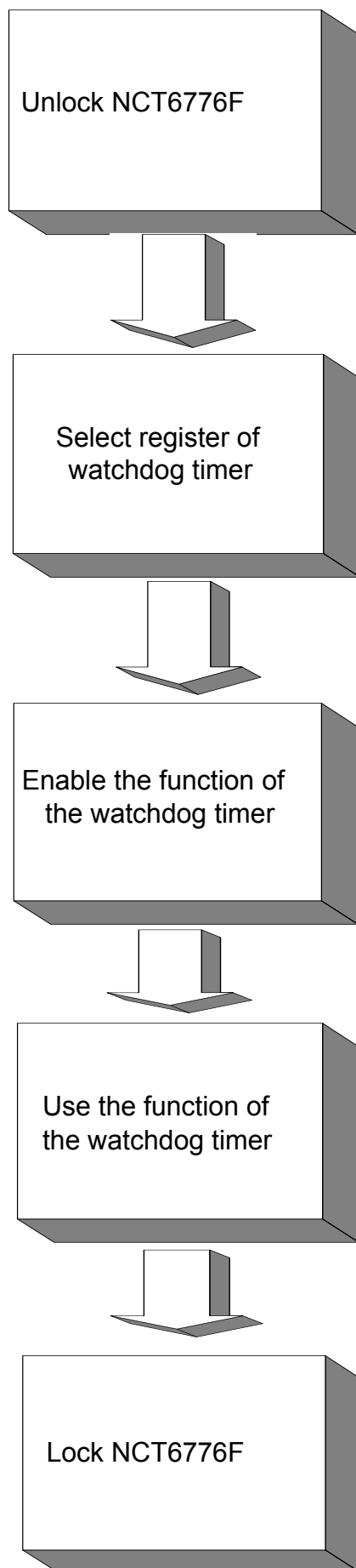

Table A.1: Watchdog timer registers

Address of register (2E)	Read/Write	Value (2F) & description
87 (hex)	-	Write this address to I/O address port 2E (hex) twice to unlock the NCT6776F
07 (hex)	write	Write 08 (hex) to select register of watchdog timer.
30 (hex)	write	Write 01 (hex) to enable the function of the watchdog timer. Disabled is set as default.
F5 (hex)	write	Set seconds or minutes as units for the timer. Write 0 to bit 3: set seconds as counting unit. [default]. Write 1 to bit 3: set minutes as counting unit. Write 1 to bit 4: Watchdog timer count mode is 1000 times faster. If bit 3 is 0, the count mode is 1/1000 seconds mode. If bit 3 is 1, the count mode is 1/1000 minutes mode.
F6 (hex)	write	0: stop timer [default] 01 ~ FF (hex): The amount of the count, in seconds or minutes, depends on the value set in register F5 (hex). This number decides how long the watchdog timer waits for strobe before generating an interrupt or reset signal. Writing a new value to this register can reset the timer to count with the new value.
F7 (hex)	read/write	Bit 6: Write 1 to enable keyboard to reset the timer, 0 to disable. [default] Bit 5: Write 1 to generate a timeout signal immediately and automatically return to 0. [default=0] Bit 4: Read status of watchdog timer, 1 means timer is "timeout".
AA (hex)	-	Write this address to I/O port 2E (hex) to lock NCT6776F.

A.2.1 Example Programs

Enable watchdog timer and set 10 seconds as the timeout interval

```

;-----
Mov dx,2eh ; Unlock NCT6776F
Mov al,87h
Out dx,al
Out dx,al
;-----
Mov al,07h ; Select registers of watchdog timer
Out dx,al
Inc dx
in al,dx
Or al,08h
Out dx,al
;-----
Dec dx; Enable the function of watchdog timer
Mov al,30h
Out dx,al
Inc dx
Mov al,01h
Out dx,al
;-----

```



```

Dec dx ; Set second as counting unit
Mov al,0f5h
Out dx,al
Inc dx
In al,dx
And al,not 08h
Out dx,al
;-----
Dec dx ; Set timeout interval as 10 seconds and start counting
Mov al,0f6h
Out dx,al
Inc dx
Mov al,10; 10 minutes
Out dx,al
;-----
Dec dx ; lock NCT6776F
Mov al,0aah
Out dx,al
Enable watchdog timer and set 5 minutes as the timeout interval
;-----
Mov dx,2eh ; unlock NCT6776F
Mov al,87h
Out dx,al
Out dx,al
;-----
Mov al,07h ; Select registers of watchdog timer
Out dx,al
Inc dx
In al,dx
Or al,08h
Out dx,al
;-----
Dec dx ; Enable the function of watchdog timer
Mov al,30h
Out dx,al
Inc dx
Mov al,01h
Out dx,al
;-----
Dec dx ; Set minute as counting unit
Mov al,0f5h
Out dx, al
Inc dx
In al,dx
Or al, 08h

```

```

Out dx,al
;-----
Dec dx ; Set timeout interval as 5 minutes and start counting
Mov al,0f6h
Out dx,al
Inc dx
Mov al,5; 5 minutes
Out dx,al
;-----
Dec dx ; lock NCT6776F
Mov al,0aah
Out dx,al
Enable watchdog timer to be reset by mouse
;-----
Mov dx,2eh ; unlock NCT6776F
Mov al,87h
Out dx,al
Out dx,al
;-----
Mov al,07h ; Select registers of watchdog timer
Out dx,al
Inc dx
Mov al,08h
Out dx,al
;-----
Dec dx ; Enable the function of watchdog timer
Mov al,30h
Out dx,al
Inc dx
In al,dx
Or al,01h
Out dx,al
;-----
Dec dx ; Enable watchdog timer to be reset by mouse
Mov al,0f7h
Out dx,al
Inc dx
In al,dx
Or al,80h
Out dx,al
;-----
Dec dx ; lock NCT6776F
Mov al,0aah
Out dx,al
Enable watchdog timer to be reset by keyboard

```

```

;-----
Mov dx,2eh ; unlock NCT6776F
Mov al,87h
Out dx,al
Out dx,al
;-----
Mov al,07h ; Select registers of watchdog timer
Out dx,al
Inc dx
Mov al,08h
Out dx,al
;-----
Dec dx ; Enable the function of watchdog timer
Mov al,30h
Out dx,al
Inc dx
Mov al,01h
Out dx,al
;-----
Dec dx ; Enable watchdog timer to be strobed reset by keyboard
Mov al,0f7h
Out dx,al
Inc dx
In al,dx
Or al,40h
Out dx,al
;-----
Dec dx ; lock NCT6776F
Mov al,0aah
Out dx,al
Generate a time-out signal without timer counting
;-----
Mov dx,2eh ; unlock NCT6776F
Mov al,87h
Out dx,al
Out dx,al
;-----
Mov al,07h ; Select registers of watchdog timer
Out dx,al
Inc dx
Mov al,08h
Out dx,al
;-----
Dec dx ; Enable the function of watchdog timer
Mov al,30h

```

```
Out dx,al
Inc dx
In al,dx
Or al,01h
Out dx,al
;-----
Dec dx ; Generate a time-out signal
Mov al,0f7h
Out dx,al ;Write 1 to bit 5 of F7 register
Inc dx
In al,dx
Or al,20h
Out dx,al
;-----
Dec dx ; lock NCT6776F
Mov al,0aah
Out dx,al
```

Appendix **B**

I/O Pin Assignments

B.1 Parallel Port (LPT1)

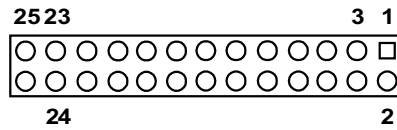

Table B.1: Parallel Port (LPT1)

Pin	Signal	Pin	Signal
1	STROBE*	14	GND*
2	AFD*	15	D6
3	D0	16	IGND
4	ERR*	17	D7
5	D1	18	GND
6	INIT*	19	ACK*
7	D2	20	GND
8	SLIN*	21	BUSY
9	D3	22	GND
10	GND	23	PE
11	D4	24	GND
12	GND	25	SLCT
13	D5	26	N/C

B.2 USB2.0 Header (USB6~11)

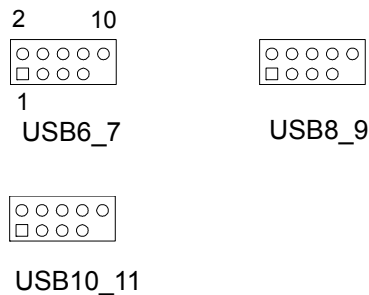

Table B.2: USB Header (USB6~11)

Pin	Signal	Pin	Signal
1	USB_VCC5	2	USB_VCC5
3	USB_D-	4	USB_D-
5	USB_D+	6	USB_D+
7	GND	8	GND
9	Key	10	N/C

B.3 USB3.0 Header (USB2_3)

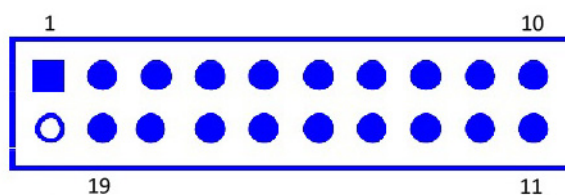

Table B.3: USB 3.0 Header (USB2_3)

Pin	Signal	Pin	Signal
1	+5V_USB2_3	20	NC
2	USB3_RX_DN5	19	+5V_USB2_3
3	USB3_RX_DP5	18	USB3_RX_DN6
4	GND	17	USB3_RX_DP6
5	USB3_TX_DN5	16	GND
6	USB3_TX_DP5	15	USB3_TX_DN6
7	GND	14	USB3_TX_DP6
8	USB2_N2	13	GND
9	USB2_P2	12	USB2_N3
10	USB_OC	11	USB2_P3

B.4 VGA Connector (VGA)

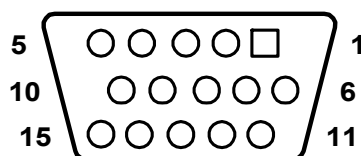

Table B.4: VGA Connector (VGA)

Pin	Signal	Pin	Signal
1	RED	9	VCC
2	GREEN	10	GND
3	BLUE	11	N/C
4	N/C	12	SDT
5	GND	13	H-SYNC
6	GND	14	V-SYNC
7	GND	15	SCK
8	GND		

B.5 RS-232 Interface (COM2)

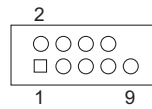

Table B.5: RS-232 Interface (COM2)

COM1/COM2

Pin	Signal
1	DCD
2	DSR
3	RXD
4	RTS
5	TXD
6	CTS
7	DTR
8	RI
9	GND

B.6 External Keyboard and Mouse Connector (KBMS2)

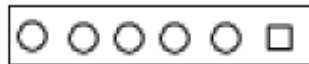

Table B.6: External Keyboard and Mouse Connector (KBMS2)

Pin	Signal
1	KB CLK
2	KB DATA
3	MS DATA
4	GND
5	VCC
6	MS CLK

B.7 System Fan Power Connector (SYSFAN0~3)

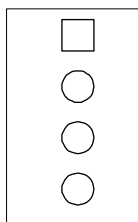

Table B.7: Fan Power Connector

Pin	Signal
1	GND
2	+12 V
3	DETECT
4	PWM

B.8 Power LED and Keyboard Lock (JFP3)

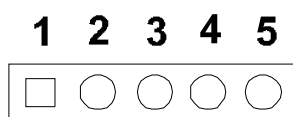

Table B.8: Power LED and Keyboard Lock (JFP3)

Pin	Function
1	LED power + (3.3 V)
2	NC
3	LED power -
4	#keylock
5	Ground

B.9 External Speaker Connector (JFP2)



Table B.9: External Speaker Connector (JFP2)

Pin	Function
1	SPK_VCC
4	SPK_OBS
7	SPK_BUZ
10	SPK_OUT

B.10 Reset Connector (JFP1)

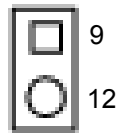

Table B.10: Reset Connector (JFP1)

Pin	Signal
9	RESET
12	GND

B.11 HDD LED Connector (JFP2)

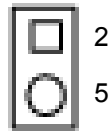

Table B.11: HDD LED Connector (JFP2)

Pin	Signal
2	HDD_LED+
5	HDD_LED-

B.12 ATX Soft Power Switch (JFP1)

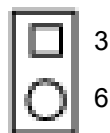

Table B.12: ATX Soft Power Switch (JFP1)

Pin	Signal
3	PWR-BTN
6	GND

B.13 USB/LAN ports (LAN1_USB01 and LAN2_USB23)

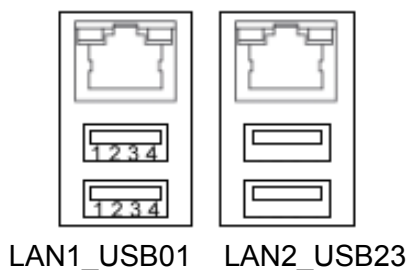

Table B.13: USB Port

Pin	Signal	Pin	Signal
1	VCC_DUAL	3	Data0+
2	Data0-	4	GND

Table B.14: Giga LAN 10/100/1000 Mbps RJ-45 port

Pin	Signal	Pin	Signal
1	MID0+	5	MID2+
2	MID0-	6	MID2+
3	MID1+	7	MID3+
4	MID1-	8	MID3+

B.14 Front Panel Audio Connector (FPAUD1)

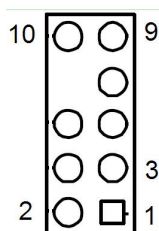

Table B.15: Front Panel Audio Connector (FPAUD1)

Pin	Signal
1	MIC2_L
2	AGND
3	MIC2_R
4	PRESENSE
5	LIN2_R
6	MIC_DEC
7	FIO_JD
8	N/A
9	LIN2_L
10	LINEOUT2_DEC

B.15 8-pin Alarm Board Connector (VOLT1)

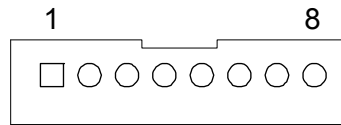

Table B.16: 8-pin Alarm Board Connector (VOLT1)

Pin	Signal	Pin	Signal
1	5VSB	5	VCC
2	GND	6	VCC3
3	GND	7	-12V
4	-5V	8	+12V

B.16 Case Open Connector (JCASE1)

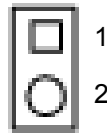

Table B.17: Case Open Connector (JFP1)

Pin	Signal
1	CASEOP
2	GND

B.17 Front Panel LAN LED Connector (LAN_LED1/2)

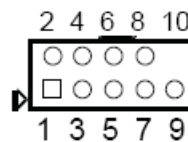

Table B.18: LAN LED Connector (LAN_LED1/2)

Pin	Signal	Pin	Signal
1	LAN1/3_LED0_ACT	2	LAN2/4_LED1_ACT
3	VCC3_LAN1/3LED	4	VCC3_LAN2/4LED
5	LAN1/3_LED1_1000M	6	LAN2/4_LED2_1000
7	LAN1/3_LED2_100M	8	LAN2/4_LED0_100
9	VCC3	10	N/C

B.18 SPI_CN1: SPI flash card pin connector

Table B.19: SPI_CN1:SPI fresh card pin connector

Pin	Signal	Pin	Signal
1	+3VSB	2	GND
3	SPI_CS#	4	SPI_CLK
5	SPI_MISO	6	SPI_MOSI
7	N/A	8	NC

B.19 SMBUS1: Connector of SMBUS from PCH

1 2 3 4



Table B.20: SMBUS Connector

Pin	Signal
1	+5V
2	Clock
3	Data
4	GND

B.20 System I/O Ports

Table B.21: System I/O ports

Addr. range (Hex)	Device
000-01F	DMA controller
020-021	Interrupt controller 1, programmable interrupt controller
022-03F	Motherboard resources
040-043	System timer
060-060	Standard PS/2 Keyboard
064-064	Standard PS/2 Keyboard
070-077	Real-time clock, non-maskable interrupt (NMI) mask
081-091	DMA controller
0A0-0A1	Interrupt controller 2, programmable interrupt controller
0C0-0DF	DMA controller
0F0-0F0	Numeric data processor
A35-A36	On-board hardware monitor
2F8-2FF	Serial port 2
778-77F	Printer port (LPT1)
3B0-3BB	Intel HD Graphics
3C0-3DF	Intel HD Graphics
3F8-3FF	Serial port 1

B.21 Interrupt Assignments

Table B.22: Interrupt assignments

Priority	Interrupt#	Interrupt source
1	NMI	Parity error detected
2	IRQ0	Interval timer
3	IRQ1	PS/2 Keyboard
-	IRQ2	Interrupt from controller 2 (cascade)
4	IRQ8	Real-time clock
5	IRQ9	Cascaded to INT 0A (IRQ 2)
6	IRQ10	Intel 8 series/C226 Chipset Family SMBus Controller
7	IRQ11	Available
8	IRQ12	PS/2 mouse
9	IRQ13	Numeric data processor
10	IRQ14	Available
11	IRQ15	Available
12	IRQ3	Serial communication port 2
13	IRQ4	Serial communication port 1
14	IRQ5	Available
15	IRQ6	Available
16	IRQ7	Parallel port 1 (print port)

B.22 1st MB Memory Map

Table B.23: 1st MB memory map

Addr. range (Hex)	Device
E0000h - FFFFFh	BIOS
CC000h - DFFFFh	Unused
C0000h - CBFFFh	VGA BIOS
A0000h - BFFFFh	Video Memory
00000h - 9FFFFh	Base memory

ADVANTECH

Enabling an Intelligent Planet

www.advantech.com

Please verify specifications before quoting. This guide is intended for reference purposes only.

All product specifications are subject to change without notice.

No part of this publication may be reproduced in any form or by any means, electronic, photocopying, recording or otherwise, without prior written permission of the publisher.

All brand and product names are trademarks or registered trademarks of their respective companies.

© Advantech Co., Ltd. 2017