

SS40F/SS40G

Enhanced Low Cost Bipolar Hall-Effect Sensors



DESCRIPTION

The SS40F/SS40G Enhanced Low Cost Bipolar Hall-Effect Sensors are small, versatile digital Hall-Effect devices that are operated by the magnetic field from a permanent magnet or an electromagnet. These products are designed to provide a level of compensation for magnetic changes over a range of temperatures. The bipolar magnetics respond to alternating North and South poles.

A built-in regulator is designed to provide stable operation over 4.5 Vdc to 24 Vdc supply voltage range, and internal circuitry is designed to prevent sensor damage in case the supply voltage polarity is accidentally reversed.

FEATURES

- Miniature construction: 3,0 mm x 4,0 mm [0.12 in x 0.16 in] plastic package
- Power consumption of only 5 mA max at 4.5 Vdc for energy efficiency
- Bipolar magnetics for ring magnet applications
- High speed: operates from 0 kHz to over 100 kHz
- Broad temperature range of -40 °C to 125 °C [-40 °F to 257 °F]
- Built-in reverse polarity protection

The open-collector sinking output voltage is easily interfaced with a wide variety of electronic circuits.

The SS40F is factory tested at 25 °C [77 °F] and the SS40G is factory tested at both 25 °C [77 °F] and 125 °C [257 °F].

Both products are designed for cost-sensitive applications requiring reliable and quality products.

POTENTIAL APPLICATIONS

- Speed and RPM (revolutions per minute) sensing
- Brushless dc (direct current) motor commutation
- Motor and fan control
- Tachometer, counter pickup
- Flow rate sensing

SS40F/SS40G

TABLE 1. SS40F/SS40G ABSOLUTE MAXIMUM RATINGS*

Characteristic	Minimum	Typical	Maximum	Unit
Supply voltage	-28	-	28	V
Applied output voltage	-0.5	-	28	V
Output current	-	-	20	mA
Magnetic flux	-	-	no limit	gauss

***Note:**

Absolute maximum ratings are the extreme limits the device is designed to withstand without damage to the device. However, the electrical and mechanical characteristics are not guaranteed as the maximum limits (above recommended operating conditions) are approached, nor will the device necessarily operate at absolute maximum ratings.

TABLE 2. SS40F SPECIFICATIONS (At Vs = 4.5 V to 24 V with 20 mA load with Ta = 25 °C [77 °F] unless otherwise noted.

Characteristic	Condition	Minimum	Typical	Maximum	Unit
Supply voltage	-	4.5	-	24.0	V
Supply current	-	-	6.8	10.0	mA
Output current	-	-	-	20.0	mA
Vsat at 15 mA	gauss >170	-	-	0.4	V
Output leakage	gauss <-170	-	-	1.0	µA
Rise time	Vs = 4.5 V	-	0.5	1.5	µs
Fall time	Vs = 4.5 V	-	0.2	1.5	µs
Operate (Bop)	-	-	4.5 (45)	11 (110)	mT (gauss)
Release (Brp)	-	-11 (-110)	-4.5 (-45)	-	mT (gauss)
Differential	-	5.0 (50)	-	-	mT (gauss)
Operating temperature	-40 °C to 125 °C [-40 °F to 257 °F]				
Storage temperature	-55 °C to 155 °C [-67 °F to 329 °F]				

TABLE 3. SS40G SPECIFICATIONS (At Vs = 4.5 V to 24 V with 20 mA load with Ta = -40 °C to 125 °C [-40 °F to 257 °F] unless otherwise noted.

Characteristic	Condition	Minimum	Typical	Maximum	Unit
Supply voltage	-	4.5	-	24.0	V
Supply current	output OFF	-	6.8	10.0	mA
Supply current	output ON	-	-	11.3	mA
Output current	-	-	-	20.0	mA
Vsat at 20 mA	25 °C [77 °F], gauss >170	-	-	0.4	V
Output leakage	Vs = 24 V, gauss <-170	-	-	10.0	µA
Rise time	25 °C [77 °F]	-	0.5	1.5	µs
Fall time	25 °C [77 °F]	-	0.2	1.5	µs
Response time	25 °C [77 °F]	-	4.0	5.0	µs
Operate (Bop)	25 °C [77 °F]	-	4.5 (45)	11 (110)	mT (gauss)
Operate (Bop)	-40 °C to 85 °C [-40 °F to 185 °F]	-	5.0 (50)	13 (130)	mT (gauss)
Operate (Bop)	-	-	5.5 (55)	17 (170)	mT (gauss)
Release (Brp)	25 °C [77 °F]	-11 (-110)	-4.5 (-45)	-	mT (gauss)
Release (Brp)	-40 °C to 85 °C [-40 °F to 185 °F]	-13 (-130)	-5.0 (-50)	-	mT (gauss)
Release (Brp)	-	-17 (-170)	-5.5 (-55)	-	mT (gauss)
Differential	-	5.0 (50)	-	-	mT (gauss)
Operating temperature	-40 °C to 125 °C [-40 °F to 257 °F]				
Storage temperature	-55 °C to 155 °C [-67 °F to 329 °F]				

Enhanced Low Cost Bipolar Hall-Effect Sensors

FIGURE 1. WIRING DIAGRAMS

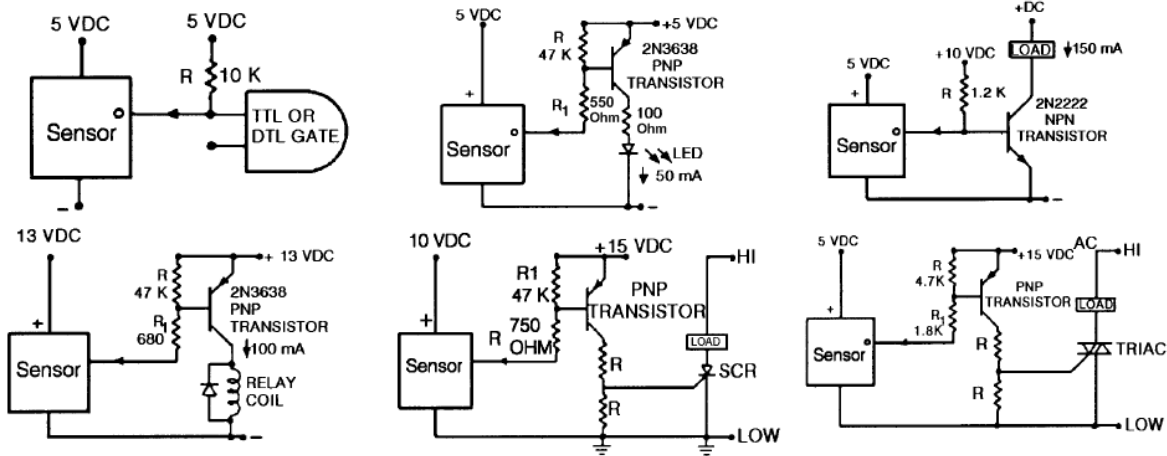

FIGURE 2: OPERATE AND RELEASE POINTS

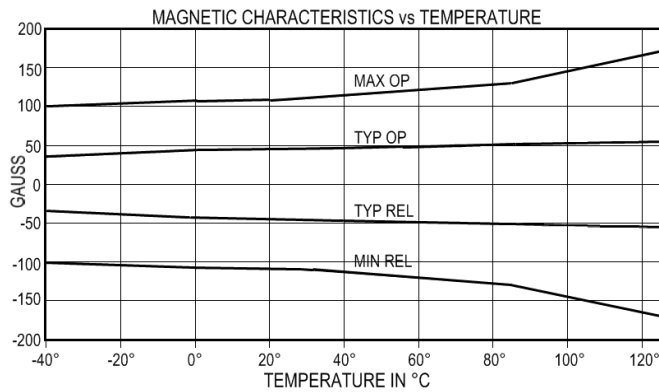
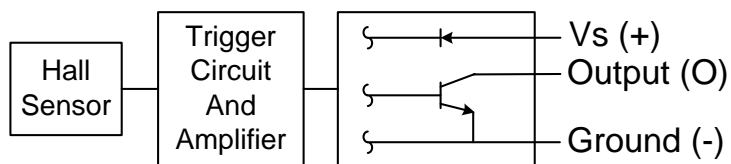

FIGURE 3. CURRENT SINKING OUTPUT DIAGRAM



SS40F/SS40G

FIGURE 4. MOUNTING DIMENSIONS (For reference only. mm/[in])

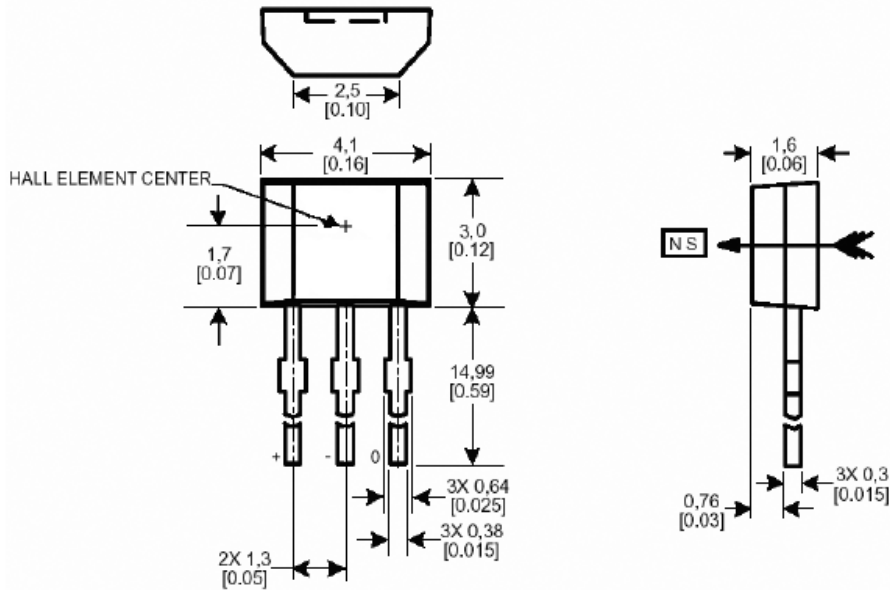

FIGURE 5. R1 OPTION MOUNTING DIMENSIONS (For reference only. mm/[in])

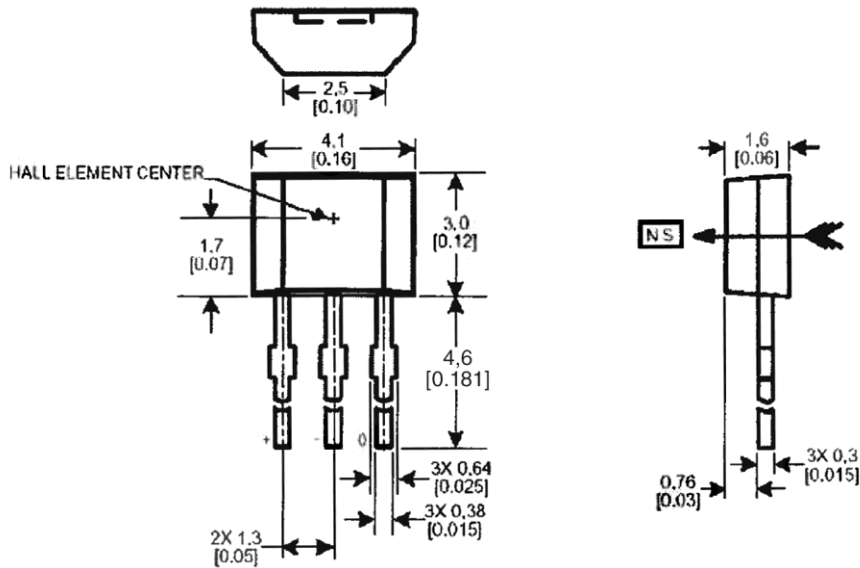
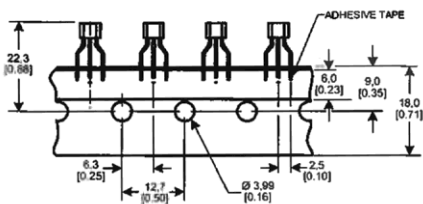

FIGURE 6. TAPE DIMENSIONS FOR STYLE T2 (For reference only. mm/[in])



NOTE: SS40F-F and SS40G-F have the same lead forming as the style T2 option; however, the SS40F-F and SS40G-F are supplied in bulk.

Enhanced Low Cost Bipolar Hall-Effect Sensors

FIGURE 7. TAPE DIMENSIONS FOR STYLE T3 (For reference only. mm/[in])

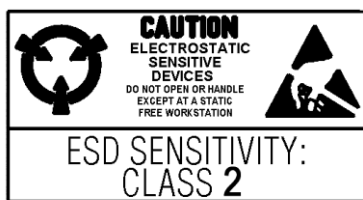
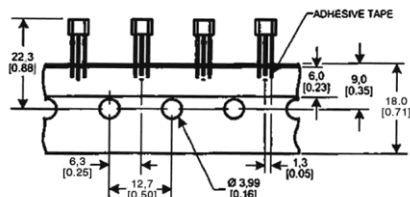

ORDER GUIDE

Catalog Listing	Description
SS40F	Bipolar hall-effect sensor, radial lead package, tested at 25 °C [77 °F], standard bulk pack with 1000 units
SS40F-F	Bipolar hall-effect sensor, radial lead package, with formed leads on 2,54 mm [0.100 in] centers, tested at 25 °C [77 °F], standard bulk pack with 1000 units
SS40F-T2	Bipolar hall-effect sensor, radial lead package tape-in-box (ammopack) version with formed leads, tested at 25 °C [77 °F]
SS40F-T3	Bipolar hall-effect sensor, radial lead package tape-in-box (ammopack) version with straight leads, tested at 25 °C [77 °F]
SS40F-R1	Bipolar hall-effect sensor, radial lead package, tested at 25 °C [77 °F], standard bulk pack with 1000 units, reduced lead length 4,6 mm [0.181 in]
SS40G	Bipolar hall-effect sensor, radial lead package, tested at 25 °C [77 °F] and 125°C [257 °F], standard bulk pack with 1000 units
SS40G-F	Bipolar hall-effect sensor, radial lead package, with formed leads on 2,54 mm [0.100 in] centers, tested at 25 °C [77 °F] and 125°C [257 °F], standard bulk pack with 1000 units
SS40G-T2	Bipolar hall-effect sensor, radial lead package tape-in-box (ammopack) version with formed leads, tested at 25 °C [77 °F] and 125°C [257 °F]
SS40G-T3	Bipolar hall-effect sensor, radial lead package tape-in-box (ammopack) version with straight leads, tested at 25 °C [77 °F] and 125°C [257 °F]
SS40G-R1	Bipolar hall-effect sensor, radial lead package, tested at 25 °C [77 °F] and 125°C [257 °F], standard bulk pack with 1000 units, reduced lead length 4,6 mm [0.181 in]

WARNING

MISUSE OF DOCUMENTATION

- The information presented in this product sheet is for reference only. Do not use this document as a product installation guide.
- Complete installation, operation, and maintenance information is provided in the instructions supplied with each product.

Failure to comply with these instructions could result in death or serious injury.

WARRANTY/REMEDY

Honeywell warrants goods of its manufacture as being free of defective materials and faulty workmanship. Honeywell's standard product warranty applies unless agreed to otherwise by Honeywell in writing; please refer to your order acknowledgement or consult your local sales office for specific warranty details. If warranted goods are returned to Honeywell during the period of coverage, Honeywell will repair or replace, at its option, without charge those items it finds defective. **The foregoing is buyer's sole remedy and is in lieu of all other warranties, expressed or implied, including those of merchantability and fitness for a particular purpose. In no event shall Honeywell be liable for consequential, special, or indirect damages.**

While we provide application assistance personally, through our literature and the Honeywell web site, it is up to the customer to determine the suitability of the product in the application.

Specifications may change without notice. The information we supply is believed to be accurate and reliable as of this printing. However, we assume no responsibility for its use.

WARNING

PERSONAL INJURY

DO NOT USE these products as safety or emergency stop devices or in any other application where failure of the product could result in personal injury.

Failure to comply with these instructions could result in death or serious injury.

SALES AND SERVICE

Honeywell serves its customers through a worldwide network of sales offices, representatives and distributors. For application assistance, current specifications, pricing or name of the nearest Authorized Distributor, contact your local sales office or:

E-mail: info.sc@honeywell.com

Internet: www.honeywell.com/sensing

Phone and Fax:

Asia Pacific	+65 6355-2828 +65 6445-3033 Fax
Europe	+44 (0) 1698 481481 +44 (0) 1698 481676 Fax
Latin America	+1-305-805-8188 +1-305-883-8257 Fax
USA/Canada	+1-800-537-6945 +1-815-235-6847 +1-815-235-6545 Fax

Sensing and Control
Honeywell
1985 Douglas Drive North
Golden Valley, MN 55422
www.honeywell.com

005888-3-EN IL50 GLO Printed in USA
July 2009
© 2009 Honeywell International Inc. All rights reserved.

Honeywell