

Six IGBT
NX-Series Module
600 Amperes/1200 Volts

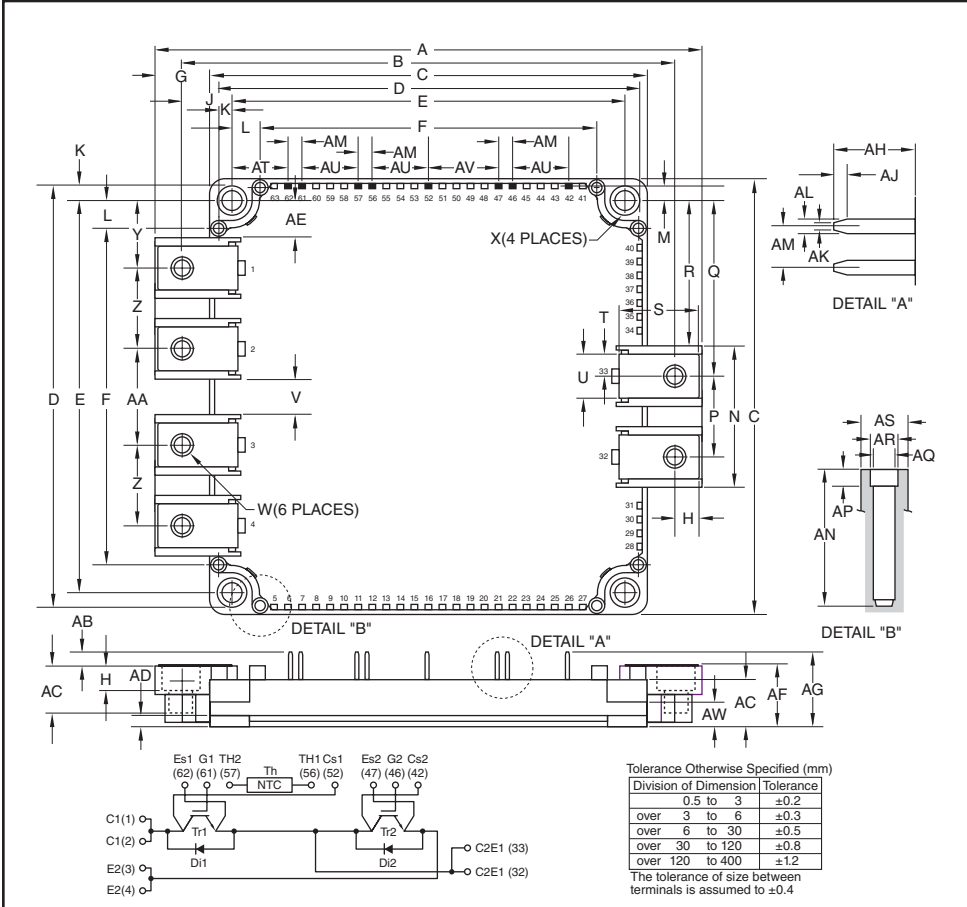

Outline Drawing and Circuit Diagram

Dimensions	Inches	Millimeters
A	5.98	152.0
B	5.39	137.0
C	4.79	121.7
D	4.61	117.2
E	4.33±0.02	110.0±0.5
F	3.72	94.5
G	0.6	15.14
H	0.26	6.5
J	0.53	13.5
K	0.14	3.6
L	0.3	7.75
M	0.016	4.05
N	1.53	39.0
P	0.86	22.0
Q	1.95	49.72
R	1.62	41.22
S	0.83	21.14
T	0.23	6.0
U	0.47	12.0
V	0.41	10.53
W	M6 Metric	M6
X	0.22 Dia.	5.5 Dia.
Y	0.75	19.24

Dimensions	Inches	Millimeters
Z	0.86	22.0
AA	1.08	27.53
AB	0.14	3.5
AC	0.51	13.0
AD	0.19	3.0
AE	0.42	10.74
AF	0.67+0.04/-0.02	17.0+1.0/-0.5
AG	0.81	20.5
AH	0.29	7.4
AJ	0.05	1.2
AK	0.02	0.65
AL	0.04	1.15
AM	0.15	3.81
AN	0.5	12.5
AP	0.12	3.0
AQ	0.088 Dia.	2.25 Dia.
AR	0.102 Dia.	2.6 Dia.
AS	0.16 Dia.	4.3 Dia.
AT	0.67	16.9
AU	0.6	15.24
AV	0.75	19.05
AW	0.27	7.0

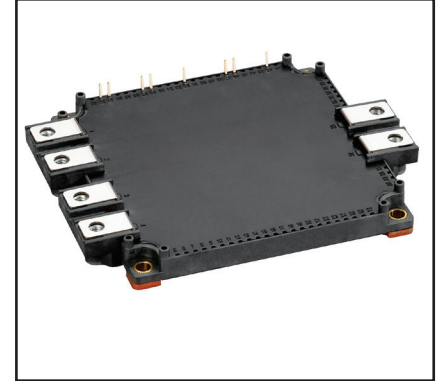

Description:

Powerex IGBT Modules are designed for use in switching applications. Each module consists of two IGBT Transistors in a half-bridge configuration with each transistor having a reverse-connected super-fast recovery free-wheel diode. All components and interconnects are isolated from the heat sinking baseplate, offering simplified system assembly and thermal management.

Features:

- Low Drive Power
- Low $V_{CE(sat)}$
- Discrete Super-Fast Recovery Free-Wheel Diode
- Isolated Baseplate for Easy Heat Sinking

Applications:

- AC Motor Control
- Motion/Servo Control
- Photovoltaic/Fuel Cell

Ordering Information:

Example: Select the complete module number you desire from the table below -i.e. CM600DXL-24S is a 1200V (V_{CES}), 600 Ampere Dual IGBT Power Module.

Type	Current Rating Amperes	V_{CES} Volts (x 50)
CM	600	24

CM600DXL-24S
Six IGBT NX-Series Module
 600 Amperes/1200 Volts

Absolute Maximum Ratings, $T_j = 25^\circ\text{C}$ unless otherwise specified

Inverter Part IGBT/FWDi

Characteristics	Symbol	Rating	Units
Collector-Emitter Voltage ($V_{GE} = 0V$)	V_{CES}	1200	Volts
Gate-Emitter Voltage ($V_{CE} = 0V$)	V_{GES}	± 20	Volts
Collector Current (DC, $T_C = 119^\circ\text{C}$)*2,*4	I_C	600	Amperes
Collector Current (Pulse)*3	I_{CRM}	1200	Amperes
Total Power Dissipation ($T_C = 25^\circ\text{C}$)*2,*4	P_{tot}	4545	Watts
Emitter Current ($T_C = 25^\circ\text{C}$)*2	I_E^{*1}	600	Amperes
Emitter Current (Pulse)*3	I_{ERM}^{*1}	1200	Amperes

Module

Characteristics	Symbol	Rating	Units
Isolation Voltage (Terminals to Baseplate, RMS, $f = 60\text{Hz}$, AC 1 minute)	V_{ISO}	2500	Volts
Maximum Junction Temperature, Instantaneous Event (Overload)	$T_{j(max)}$	175	$^\circ\text{C}$
Maximum Case Temperature*4	$T_C(max)$	125	$^\circ\text{C}$
Operating Junction Temperature, Continuous Operation (Under Switching)	$T_{j(op)}$	-40 to +150	$^\circ\text{C}$
Storage Temperature	T_{stg}	-40 to +125	$^\circ\text{C}$

*1 Represent ratings and characteristics of the anti-parallel, emitter-to-collector free wheeling diode (FWDi).

*2 Case temperature (T_C) and heatsink temperature (T_s) is measured on the surface (mounting side) of the baseplate and the heatsink side just under the chips. Refer to the figure to the right for chip location.

*3 Pulse width and repetition rate should be such that device junction temperature (T_j) does not exceed $T_{j(max)}$ rating.

*4 Junction temperature (T_j) should not increase beyond maximum junction temperature ($T_{j(max)}$) rating.

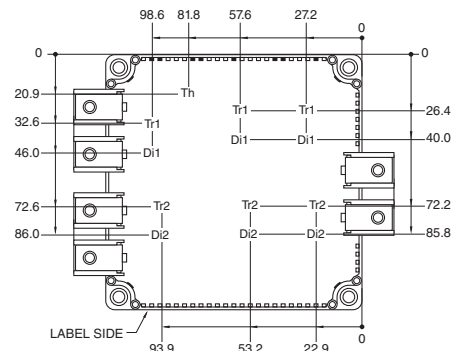

Tr1 / Tr2: IGBT, Di1 / Di2: FWDi, Th: NTC Thermistor
 Each mark points to the center position of each chip.

CM600DXL-24S
Six IGBT NX-Series Module
 600 Amperes/1200 Volts

Electrical Characteristics, $T_j = 25^\circ\text{C}$ unless otherwise specified

Inverter Part IGBT/FWDi

Characteristics	Symbol	Test Conditions	Min.	Typ.	Max.	Units
Collector-Emitter Cutoff Current	I_{CES}	$V_{CE} = V_{CES}, V_{GE} = 0V$	—	—	1.0	mA
Gate-Emitter Leakage Current	I_{GES}	$V_{GE} = V_{GES}, V_{CE} = 0V$	—	—	0.5	μA
Gate-Emitter Threshold Voltage	$V_{GE(th)}$	$I_C = 60\text{mA}, V_{CE} = 10V$	5.4	6.0	6.6	Volts
Collector-Emitter Saturation Voltage	$V_{CE(sat)}$ (Terminal)	$I_C = 600\text{A}, V_{GE} = 15V, T_j = 25^\circ\text{C}^{*5}$	—	1.85	2.30	Volts
		$I_C = 600\text{A}, V_{GE} = 15V, T_j = 125^\circ\text{C}^{*5}$	—	2.05	—	Volts
		$I_C = 600\text{A}, V_{GE} = 15V, T_j = 150^\circ\text{C}^{*5}$	—	2.10	—	Volts
Collector-Emitter Saturation Voltage	$V_{CE(sat)}$ (Chip)	$I_C = 600\text{A}, V_{GE} = 15V, T_j = 25^\circ\text{C}^{*5}$	—	1.70	2.15	Volts
		$I_C = 600\text{A}, V_{GE} = 15V, T_j = 125^\circ\text{C}^{*5}$	—	1.90	—	Volts
		$I_C = 600\text{A}, V_{GE} = 15V, T_j = 150^\circ\text{C}^{*5}$	—	1.95	—	Volts
Input Capacitance	C_{ies}		—	—	60	nF
Output Capacitance	C_{oes}	$V_{CE} = 10V, V_{GE} = 0V$	—	—	12	nF
Reverse Transfer Capacitance	C_{res}		—	—	1.0	nF
Gate Charge	Q_G	$V_{CC} = 600V, I_C = 600\text{A}, V_{GE} = 15V$	—	1400	—	nC
Turn-on Delay Time	$t_{d(on)}$		—	—	800	ns
Rise Time	t_r	$V_{CC} = 600V, I_C = 600\text{A}, V_{GE} = \pm 15V,$	—	—	200	ns
Turn-off Delay Time	$t_{d(off)}$	$R_G = 0\Omega, \text{Inductive Load}$	—	—	600	ns
Fall Time	t_f		—	—	300	ns
Emitter-Collector Voltage	V_{EC}^{*1} (Terminal)	$I_E = 600\text{A}, V_{GE} = 0V, T_j = 25^\circ\text{C}^{*5}$	—	1.85	2.30	Volts
		$I_E = 600\text{A}, V_{GE} = 0V, T_j = 125^\circ\text{C}^{*5}$	—	1.85	—	Volts
		$I_E = 600\text{A}, V_{GE} = 0V, T_j = 150^\circ\text{C}^{*5}$	—	1.85	—	Volts
Emitter-Collector Voltage	V_{EC}^{*1} (Chip)	$I_E = 600\text{A}, V_{GE} = 0V, T_j = 25^\circ\text{C}^{*5}$	—	1.70	2.15	Volts
		$I_E = 600\text{A}, V_{GE} = 0V, T_j = 125^\circ\text{C}^{*5}$	—	1.70	—	Volts
		$I_E = 600\text{A}, V_{GE} = 0V, T_j = 150^\circ\text{C}^{*5}$	—	1.70	—	Volts
Reverse Recovery Time	t_{rr}^{*1}	$V_{CC} = 600V, I_E = 600\text{A}, V_{GE} = \pm 15V$	—	—	300	ns
Reverse Recovery Charge	Q_{rr}^{*1}	$R_G = 0\Omega, \text{Inductive Load}$	—	32	—	μC
Turn-on Switching Energy per Pulse	E_{on}	$V_{CC} = 600V, I_C = I_E = 600\text{A}, V_{GE} = \pm 15V$	—	20.3	—	mJ
Turn-off Switching Energy per Pulse	E_{off}	$R_G = 0\Omega, T_j = 150^\circ\text{C}$	—	60.1	—	mJ
Reverse Recovery Energy per Pulse	E_{rr}^{*1}	Inductive Load	—	69.2	—	mJ
Internal Lead Resistance	$R_{CC} + EE'$	Main Terminals-Chip, Per Switch, $T_C = 25^\circ\text{C}^{*2}$	—	—	0.8	$\text{m}\Omega$
Internal Gate Resistance	r_g	Per Switch	—	3.3	—	Ω

*1 Represent ratings and characteristics of the anti-parallel, emitter-to-collector free wheeling diode (FWDi).

*2 Case temperature (T_C) and heatsink temperature (T_S) is measured on the surface (mounting side) of the baseplate and the heatsink side just under the chips. Refer to the figure to the right for chip location. The heatsink thermal resistance should be measured just under the chips.

*5 Pulse width and repetition rate should be such as to cause negligible temperature rise.

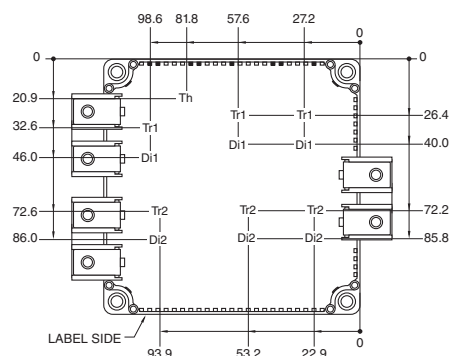

CM600DXL-24S
Six IGBT NX-Series Module
 600 Amperes/1200 Volts

Electrical Characteristics, $T_j = 25^\circ\text{C}$ unless otherwise specified (continued)

NTC Thermistor Part

Characteristics	Symbol	Test Conditions	Min.	Typ.	Max.	Units
Zero Power Resistance	R_{25}	$T_C = 25^\circ\text{C}^{*2}$	4.85	5.00	5.15	k Ω
Deviation of Resistance	$\Delta R/R$	$T_C = 100^\circ\text{C}^{*2}$, $R_{100} = 493\Omega$	-7.3	—	+7.8	%
B Constant	$B_{(25/50)}$	Approximate by Equation ^{*6}	—	3375	—	K
Power Dissipation	P_{25}	$T_C = 25^\circ\text{C}^{*4}$	—	—	10	mW

Thermal Resistance Characteristics

Thermal Resistance, Junction to Case ^{*2}	$R_{th(j-c)Q}$	Per Inverter IGBT	—	—	33	K/kW
Thermal Resistance, Junction to Case ^{*2}	$R_{th(j-c)D}$	Per Inverter FWDi	—	—	63	K/kW
Contact Thermal Resistance, Case to Heatsink ^{*2}	$R_{th(c-f)}$	Thermal Grease Applied, Per 1 Module ^{*7}	—	7	—	K/kW

Mechanical Characteristics

Mounting Torque	M_t	Main Terminals, M6 Screw	31	35	40	in-lb
Mounting Torque	M_s	Mounting to Heatsink, M5 Screw	22	27	31	in-lb
Creepage Distance	d_s	Terminal to Terminal	13.2	—	—	mm
		Terminal to Baseplate	15.3	—	—	mm
Clearance	d_a	Terminal to Terminal	13.2	—	—	mm
		Terminal to Baseplate	14.8	—	—	mm
Weight	m		—	690	—	Grams
Flatness of Baseplate	e_c	On Centerline X, Y ^{*8}	± 0	—	± 100	μm

Recommended Operating Conditions, $T_a = 25^\circ\text{C}$

DC Supply Voltage	V_{CC}	Applied Across C1-E2 Terminals	—	600	850	Volts
Gate-Emitter Drive Voltage	$V_{GE(on)}$	Applied Across	13.5	15.0	16.5	Volts
		G1-Es1/G2-Es2 Terminals				
External Gate Resistance	R_G	Per Switch	0	—	6.8	Ω

^{*2} Case temperature (T_C) and heatsink temperature (T_S) is measured on the surface (mounting side) of the baseplate and the heatsink side just under the chips. Refer to the figure to the right for chip location. The heatsink thermal resistance should be measured just under the chips.

^{*6} $B_{(25/50)} = \ln\left(\frac{R_{25}}{R_{50}}\right) / \left(\frac{1}{T_{25}} - \frac{1}{T_{50}}\right)$

R_{25} ; Resistance at Absolute Temperature T_{25} [K]; $T_{25} = 25 [^\circ\text{C}] + 273.15 = 298.15$ [K]

R_{50} ; Resistance at Absolute Temperature T_{50} [K]; $T_{50} = 50 [^\circ\text{C}] + 273.15 = 323.15$ [K]

^{*7} Typical value is measured by using thermally conductive grease of $\lambda = 0.9$ [W/(m • K)].

^{*8} Baseplate (mounting side) flatness measurement points (X, Y) are shown in the figure below.

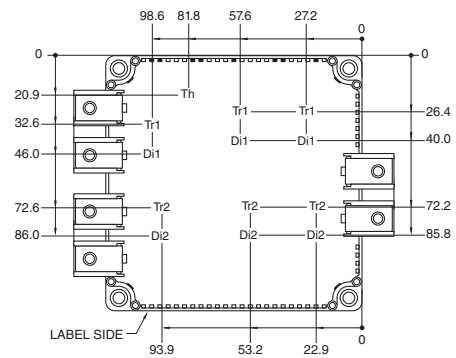
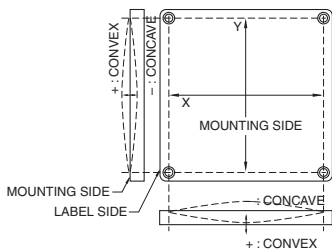

Tr1 / Tr2: IGBT, D1 / D2: FWDi, Th: NTC Thermistor
 Each mark points to the center position of each chip.

CM600DXL-24S
Six IGBT NX-Series Module
 600 Amperes/1200 Volts

OUTPUT CHARACTERISTICS (TYPICAL)

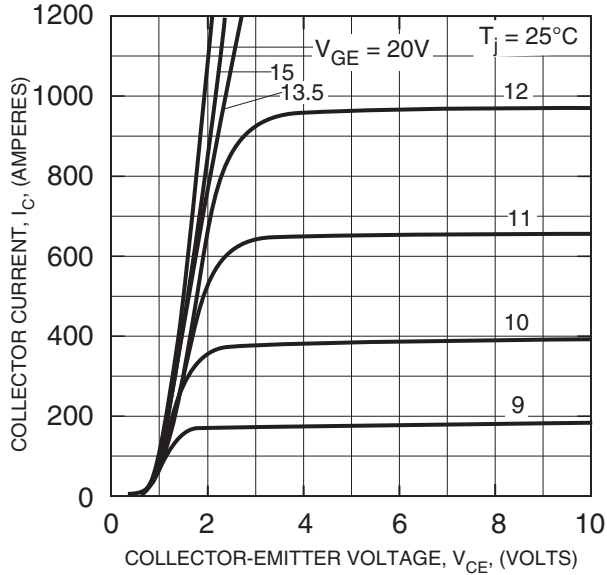

COLLECTOR-EMITTER SATURATION VOLTAGE CHARACTERISTICS (TYPICAL)

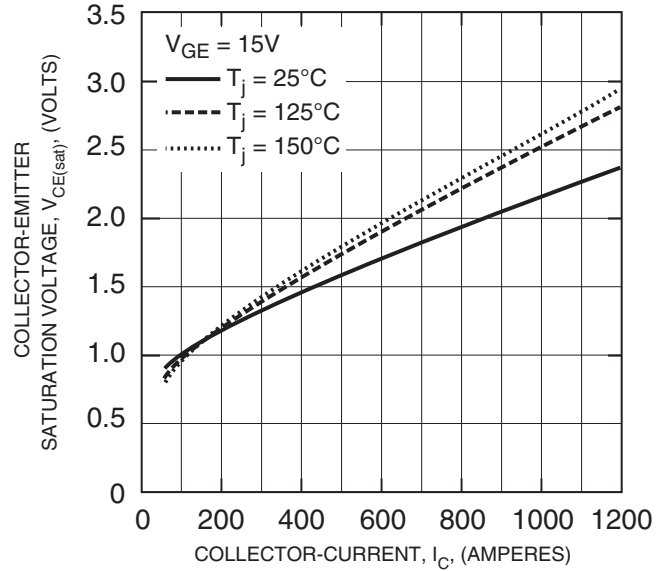

COLLECTOR-EMITTER SATURATION VOLTAGE CHARACTERISTICS (TYPICAL)

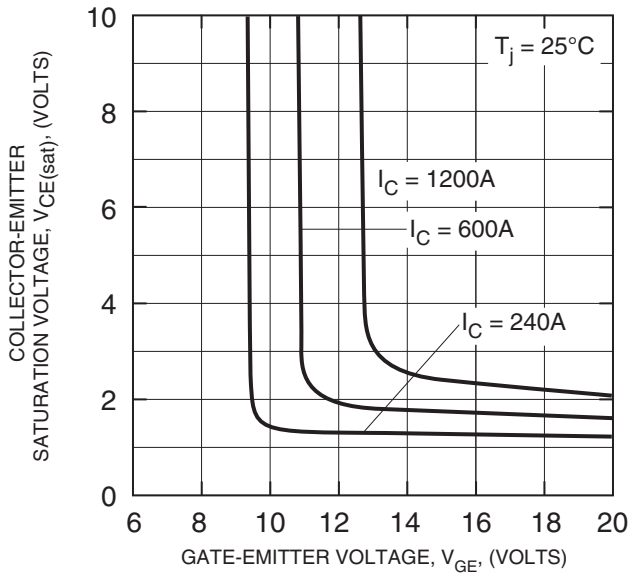

FREE-WHEEL DIODE FORWARD CHARACTERISTICS (TYPICAL)

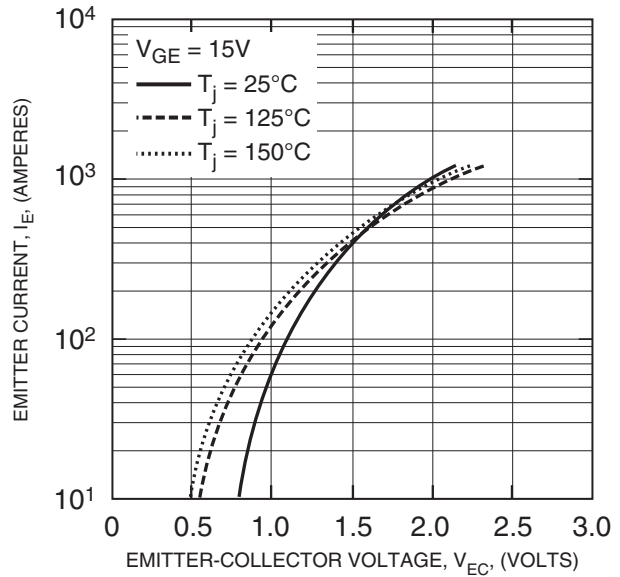

CM600DXL-24S
Six IGBT NX-Series Module
 600 Amperes/1200 Volts

CAPACITANCE VS. V_{CE}
(TYPICAL)

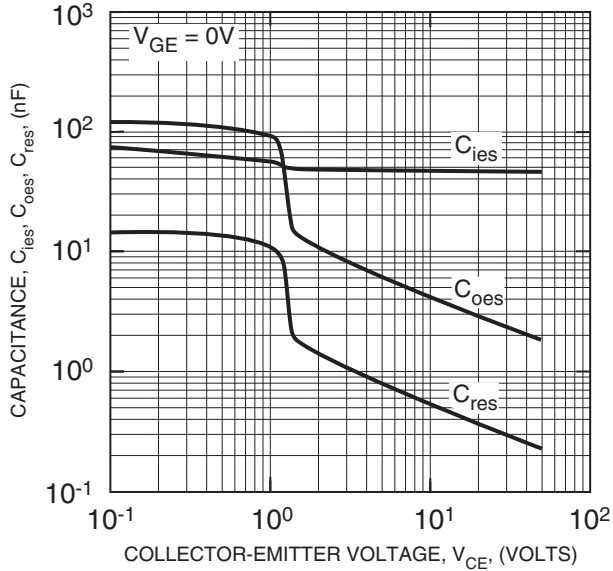

HALF-BRIDGE SWITCHING CHARACTERISTICS
(TYPICAL)

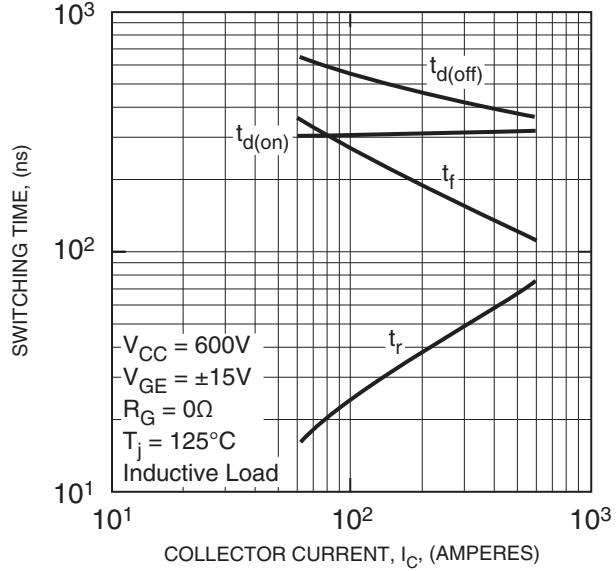

HALF-BRIDGE SWITCHING CHARACTERISTICS
(TYPICAL)

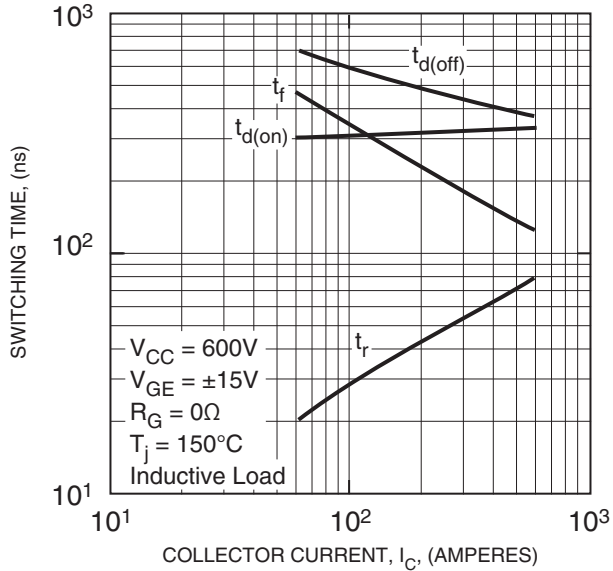

SWITCHING TIME VS. GATE RESISTANCE
(TYPICAL)

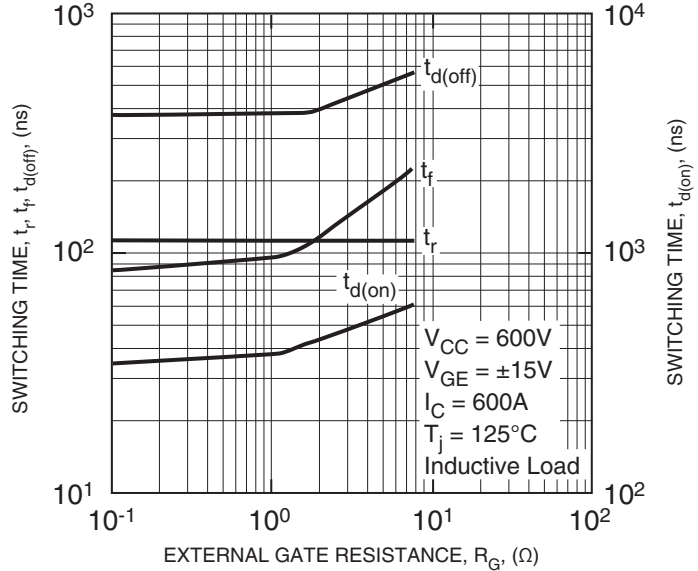

CM600DXL-24S
Six IGBT NX-Series Module
 600 Amperes/1200 Volts

SWITCHING TIME VS. GATE RESISTANCE (TYPICAL)

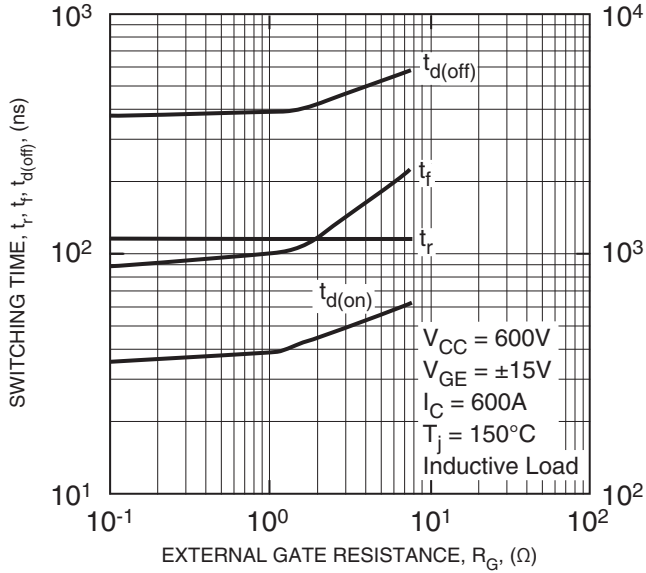

REVERSE RECOVERY CHARACTERISTICS (TYPICAL)

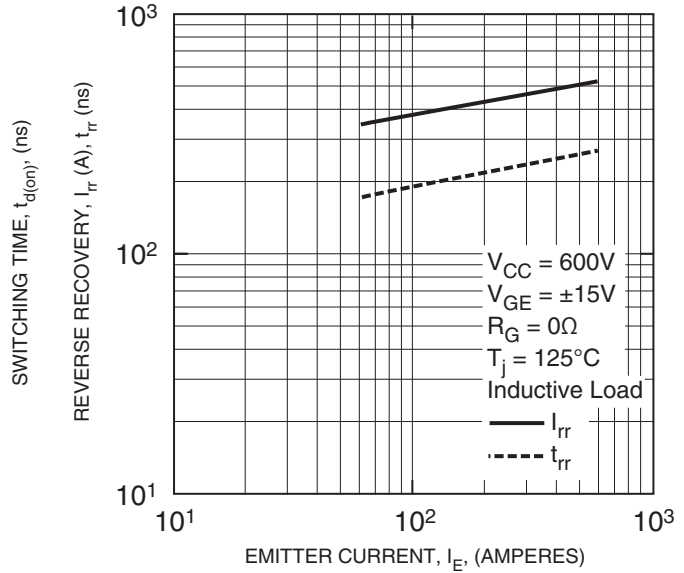

REVERSE RECOVERY CHARACTERISTICS (TYPICAL)

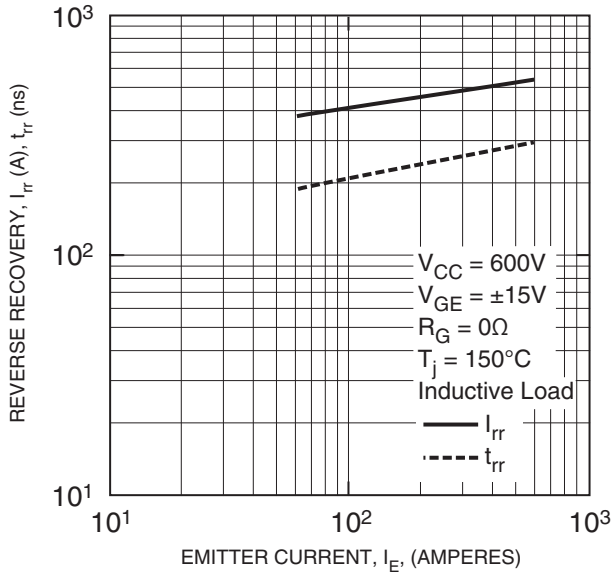

GATE CHARGE VS. V_{GE}

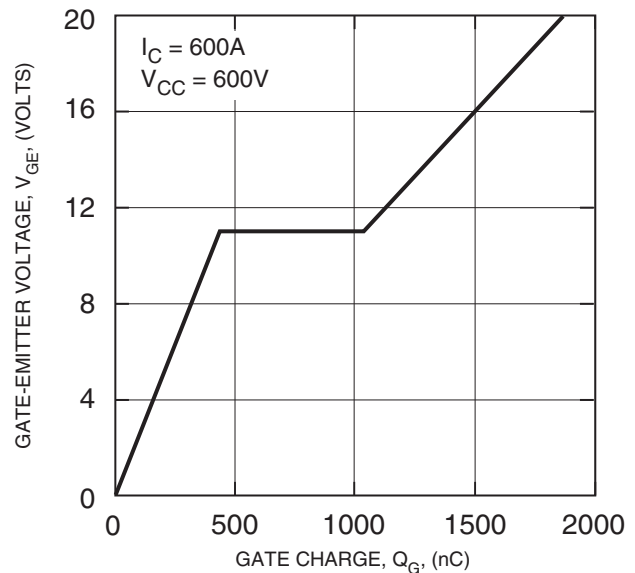

CM600DXL-24S
Six IGBT NX-Series Module
 600 Amperes/1200 Volts

HALF-BRIDGE SWITCHING CHARACTERISTICS (TYPICAL)

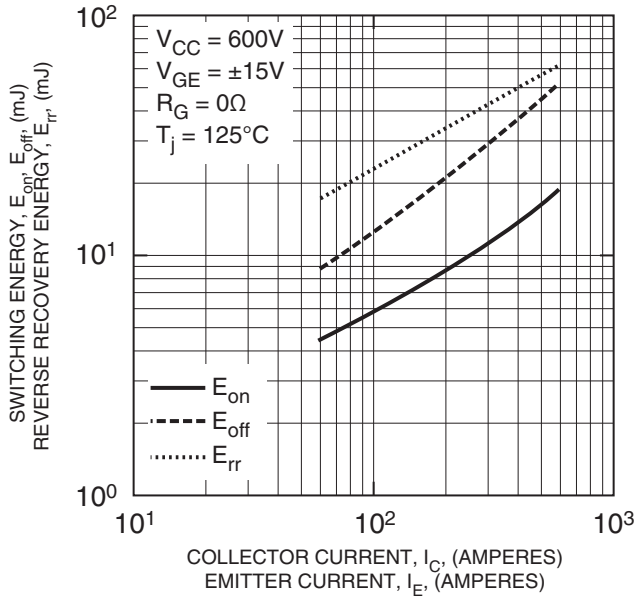

HALF-BRIDGE SWITCHING CHARACTERISTICS (TYPICAL)

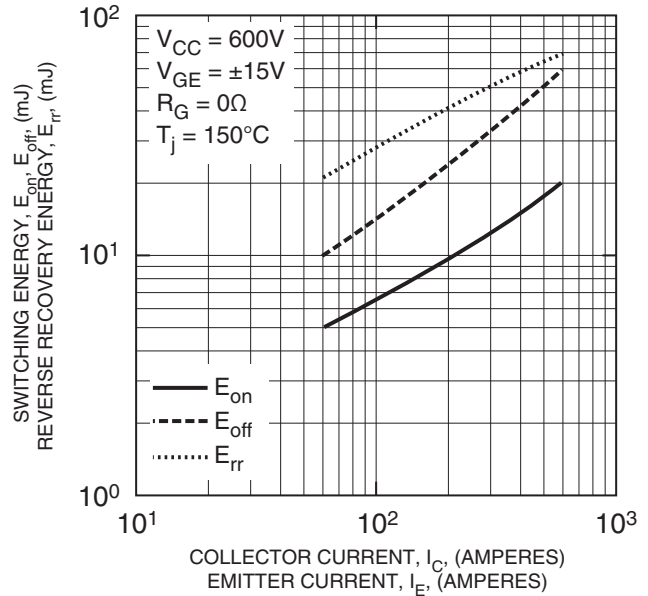

HALF-BRIDGE SWITCHING CHARACTERISTICS (TYPICAL)

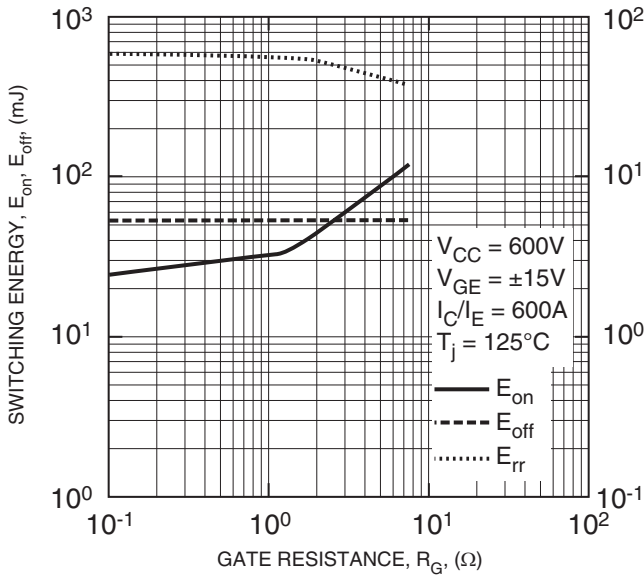

HALF-BRIDGE SWITCHING CHARACTERISTICS (TYPICAL)

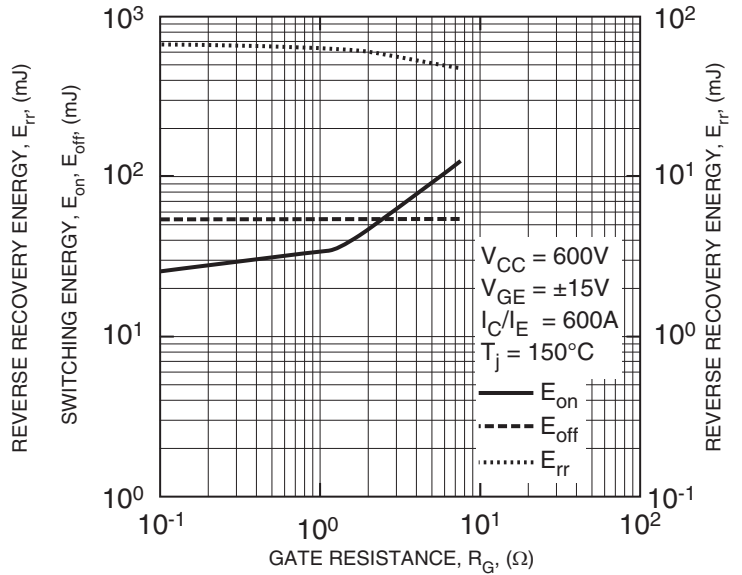

CM600DXL-24S
Six IGBT NX-Series Module
 600 Amperes/1200 Volts

