

TYS Low Profile SMD Power Inductors

CATALOGUE

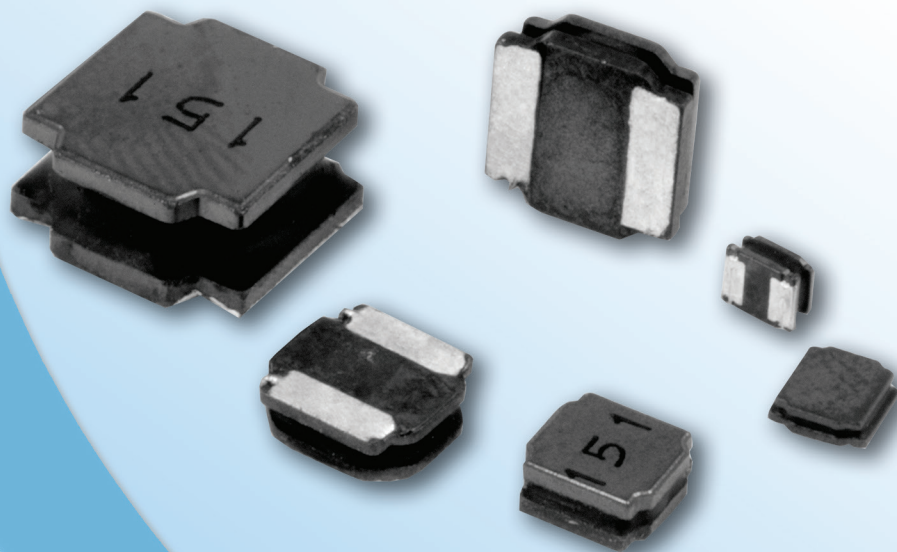

Laird[™]

ABOUT LAIRD TECHNOLOGIES

Laird Technologies designs and manufactures customized, performance-critical products for wireless and other advanced electronics applications.

The company is a global market leader in the design and supply of electromagnetic interference (EMI) shielding, thermal management products, mechanical actuation systems, signal integrity components, and wireless antennae solutions, as well as radio frequency (RF) modules and systems.

Laird Technologies partners with its customers to customize product solutions for applications in many industries including:

- Network Equipment
- Handsets
- Telecommunications
- Data Transfer & Information Technology
- Computers
- Automotive Electronics
- Aerospace
- Defense
- Medical Equipment
- Consumer Electronics
- Industrial

Laird Technologies offers its customers unique product solutions, dedication to research and development, as well as a seamless network of manufacturing and customer support facilities across the globe.



TABLE OF CONTENTS

- Features and Applications4
- Part Number Explanation.....4
- Electrical Specifications4
- Product Selection Guide5
- Shapes and Dimensions6
- TYS Series 252010L/251012L.....7
- TYS Series 3010/3012/30158
- TYS Series 4012/4018/4020/403010
- TYS Series 5020/504012
- TYS Series 6020/6028/604514
- TYS Series 804016
- Temperature Profile of Reflow Soldering16
- Packaging Information.....17
- Sample Kit Lists18



All parts listed in this catalog are lead free and RoHS compliant.

NOTICE

Laird Technologies' products or subcomponents are not specifically designed or tested by Laird Technologies for use in any medical applications, surgical applications, medical device manufacturing, or any similar procedure or process requiring approval, testing, or certification by the United States food and drug administration or other similar Governmental entity. Applications with unusual environmental requirements such as military, medical, life-support or Life-sustaining equipment are specifically not recommended without additional testing for such application.

FEATURES AND APPLICATIONS

FEATURES

- Magnetic shielded structure
- Low DCR and high efficiency
- Low profile and small size
- High reliability
- AEC-Q200 qualified

APPLICATIONS

- DC-DC converters and power suppliers
- LCD TV's, Blu-ray and gaming consoles
- Tablets, notebooks, servers and printers
- Smart phones, GPS, set top box and base stations
- LED lighting
- Automotive

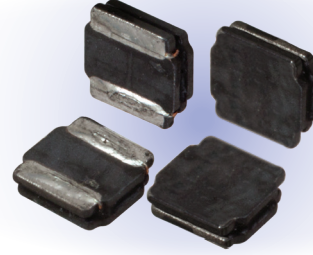

PART NUMBER EXPLANATION

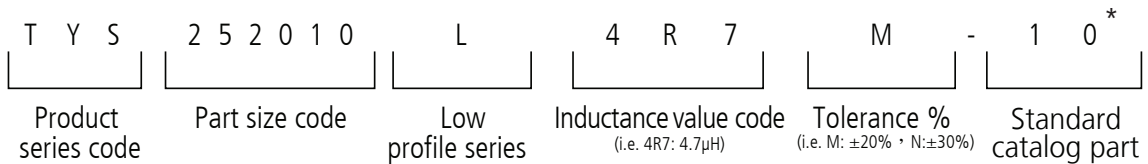

*Note:

- -10 is standard catalog part
- A new customized part number will be assigned for automotive application
- Please contact territory sales for automotive enquiry

ELECTRICAL SPECIFICATIONS

- Electrical specifications at 20°C
- Tolerance: M: ±20%, N:±30%
- Inductance tested at 100KHz, 1V
- RMS Current is defined based on temperature rise 40°C from 20°C ambient.
- Saturation Current is the DC current at which the inductance drops approximate 30% from its value without current.
- Operate temperature range: -40°C ~ +125°C(including self-heating temperature rise)
- Storage temperature range (packaging conditions):-10°C ~ 40°C and RH 70%(MAX.)

Note: RMS current is tested on a typical PCB and apply a constant current in still air. The temperature rise is dependent on the application system condition including PCB PAD pattern, trace width and thickness and adjacent components etc. It's suggest to verify the temperature rise of the component under the real operation application conditions.

TYS SERIES PRODUCT SELECTION GUIDE

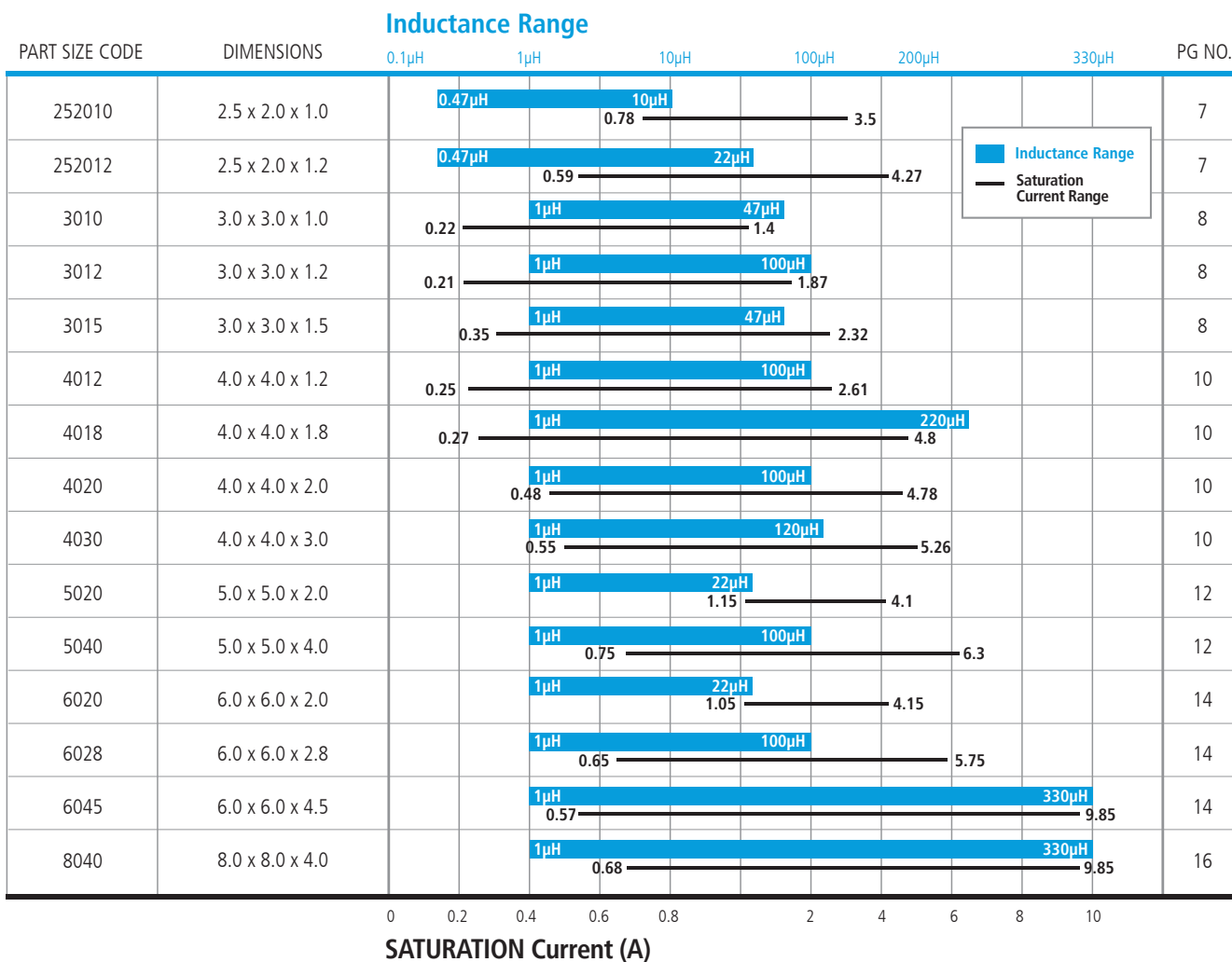
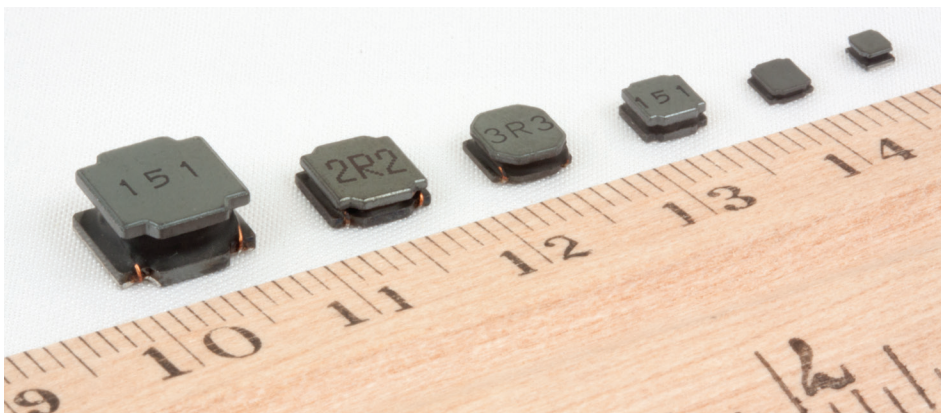

TYS SERIES SHAPES AND DIMENSIONS

SERIES (UNIT: mm)	FIGURE	A	B	C	D	E	F	a	b	c
TYS252010L	A	2.5±0.1	2.0±0.1	1.0Max.	1.5±0.2	0.80±0.2	0.80±0.2	0.8	0.85	2
TYS252012L				1.2Max.						
TYS3010	B	3.0±0.2	3.0±0.2	1.0Max.	2.5±0.2	0.75±0.2	1.5±0.2	1.5	0.8	2.7
TYS3012				1.2Max.						
TYS3015				1.5Max.						
TYS4012	B	4.0±0.2	4.0±0.2	1.2Max.	3.3±0.2	0.95±0.2	2.1±0.2	1.9	1.1	3.4
TYS4018				1.8Max.						
TYS4020				2.0Max.						
TYS4030				3.0Max.						
TYS5020	C	5.0±0.2	5.0±0.2	2.0Max.	4.0±0.2	1.25±0.2	2.5±0.2	2.3	1.4	4.2
TYS5040				4.0Max.						
TYS6020	B	6.0±0.3	6.0±0.3	2.0Max.	4.9±0.3	1.55±0.3	2.9±0.3	2.8	1.7	5.7
TYS6028				2.8Max.						
TYS6045				4.5Max.						
TYS8040	B	8.0±0.3	8.0±0.3	4.2Max.	6.3±0.3	2.00±0.3	4.0±0.3	3.8	2.2	7.5

FIGURE A

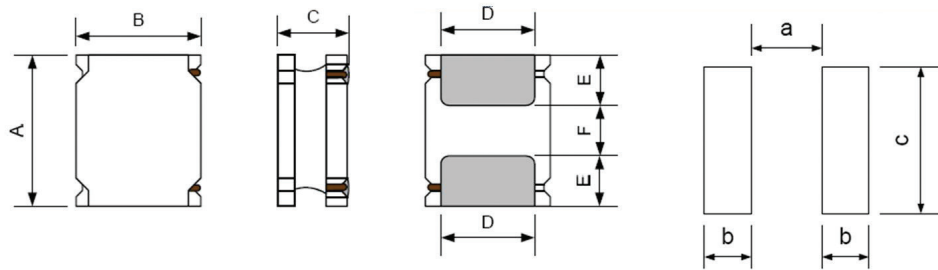

FIGURE B

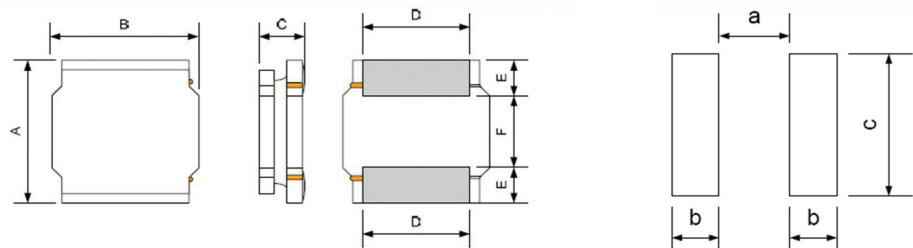
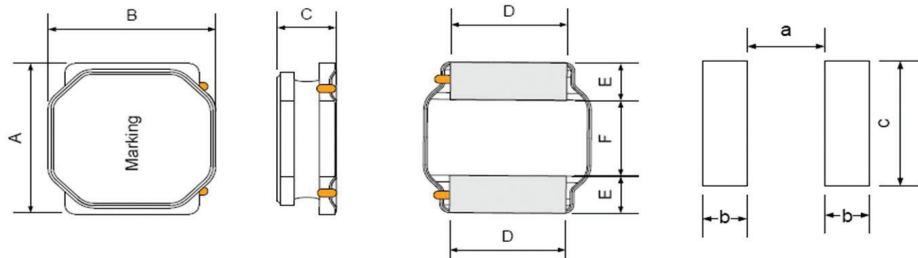

FIGURE C



TYS SERIES 252010L / 252012L

ELECTRICAL SPECIFICATIONS

PART NO.	INDUCTANCE (μH)	RDC (Ω)		SATURATION CURRENT (A)		RMS CURRENT (A)	SRF MHZ (REF)
		Max.	Typ.	Max.	Typ.	Typ.	Min.
TYS252010LR47N-10	0.47	0.056	0.047	2.50	3.35	2.35	202
TYS252010LR68N-10	0.68	0.074	0.062	2.20	2.75	2.00	138
TYS252010L1R0N-10	1	0.108	0.090	1.85	2.20	1.65	100
TYS252010L1R5N-10	1.5	0.182	0.152	1.80	2.10	1.30	79
TYS252010L2R2N-10	2.2	0.209	0.174	1.20	1.60	1.20	61
TYS252010L3R3M-10	3.3	0.328	0.273	1.05	1.30	0.90	48
TYS252010L4R7M-10	4.7	0.563	0.469	0.95	1.15	0.70	40
TYS252010L6R8M-10	6.8	0.896	0.747	0.78	0.92	0.59	32
TYS252010L100M-10	10	1.092	0.910	0.65	0.78	0.50	26
TYS252012LR47N-10	0.47	0.056	0.047	3.82	4.27	2.15	160
TYS252012L1R0N-10	1	0.083	0.069	2.59	2.90	1.93	110
TYS252012L1R5M-10	1.5	0.136	0.113	2.24	2.51	1.40	97
TYS252012L2R2M-10	2.2	0.199	0.166	1.85	2.07	1.15	69
TYS252012L3R3M-10	3.3	0.244	0.203	1.61	1.80	1.04	62
TYS252012L4R7M-10	4.7	0.348	0.290	1.12	1.25	0.84	47
TYS252012L6R8M-10	6.8	0.536	0.447	0.98	1.09	0.69	38
TYS252012L100M-10	10	0.637	0.531	0.79	0.88	0.62	34
TYS252012L150M-10	15	1.469	1.224	0.68	0.77	0.42	25
TYS252012L220M-10	22	1.824	1.520	0.53	0.59	0.38	20

TYPICAL ELECTRICAL CHARACTERISTICS

TYS252010L Typical L vs DC Current

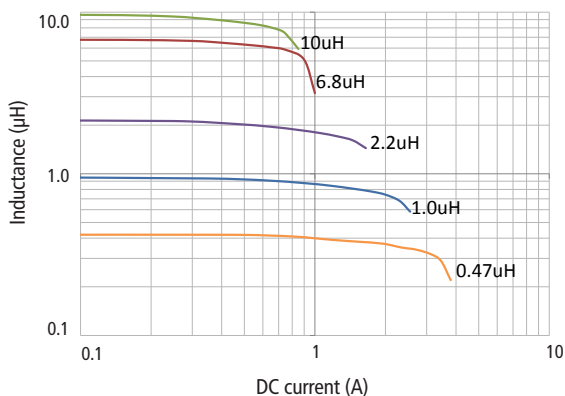

TYS252010L Temperature Rise vs DC Current

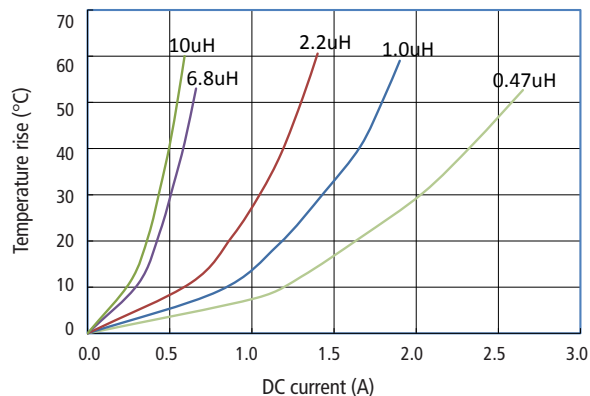

TYS252012L Typical L vs DC Current

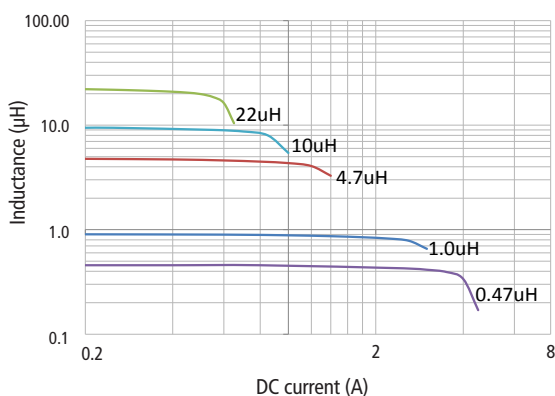

TYS252012L Temperature Rise vs DC Current

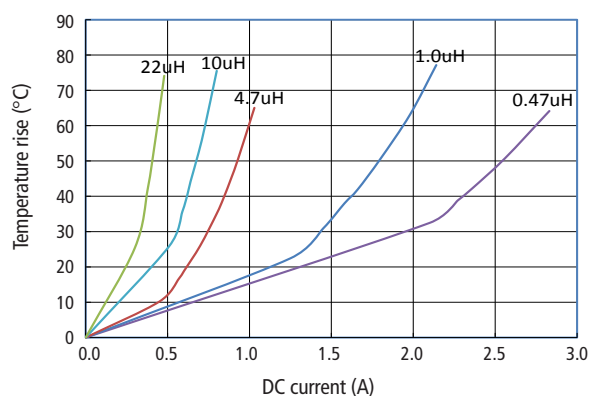

TYS SERIES 3010/3012/3015

ELECTRICAL SPECIFICATIONS

PART NO.	INDUCTANCE (μ H)	RDC (Ω) \pm 30%	SATURATION CURRENT (A)	RMS CURRENT (A)	SRF MHZ (REF)
TYS30101R0N-10	1	0.065	1.40	1.45	180
TYS30101R5N-10	1.5	0.080	1.27	1.30	120
TYS30102R2N-10	2.2	0.110	1.15	1.09	100
TYS30103R3N-10	3.3	0.145	0.97	0.96	74
TYS30104R7M-10	4.7	0.225	0.75	0.77	59
TYS30106R8M-10	6.8	0.305	0.55	0.66	42
TYS3010100M-10	10	0.400	0.55	0.58	39
TYS3010150M-10	15	0.610	0.42	0.47	30
TYS3010220M-10	22	0.930	0.35	0.38	28
TYS3010330M-10	33	1.550	0.29	0.30	18
TYS3010470M-10	47	1.950	0.22	0.26	18
TYS30121R0N-10	1	0.040	1.87	2.20	120
TYS30121R5N-10	1.5	0.045	1.62	2.01	110
TYS30122R2N-10	2.2	0.075	1.20	1.55	84
TYS30123R3M-10	3.3	0.100	1.05	1.36	64
TYS30124R7M-10	4.7	0.120	0.90	1.24	61
TYS30126R8M-10	6.8	0.190	0.75	0.98	61
TYS3012100M-10	10	0.265	0.60	0.83	42
TYS3012150M-10	15	0.460	0.45	0.71	27
TYS3012220M-10	22	0.645	0.42	0.53	23
TYS3012330M-10	33	0.875	0.36	0.46	18
TYS3012470M-10	47	1.450	0.27	0.35	14
TYS3012680M-10	68	1.670	0.24	0.33	12
TYS3012101M-10	100	2.860	0.21	0.25	12
TYS30151R0N-10	1	0.035	2.32	2.35	150
TYS30151R5N-10	1.5	0.050	2.30	1.70	100
TYS30152R2N-10	2.2	0.060	1.60	1.60	86
TYS30153R3M-10	3.3	0.088	1.32	1.36	68
TYS30154R7M-10	4.7	0.125	1.10	1.09	46
TYS30156R8M-10	6.8	0.200	0.85	0.85	39
TYS3015100M-10	10	0.250	0.72	0.77	41
TYS3015150M-10	15	0.380	0.66	0.65	30
TYS3015220M-10	22	0.460	0.52	0.57	23
TYS3015330M-10	33	0.820	0.44	0.43	20
TYS3015470M-10	47	1.250	0.35	0.35	14

TYS SERIES 3010/3012/3015

TYPICAL ELECTRICAL CHARACTERISTICS

TYS3010 Typical L vs DC Current

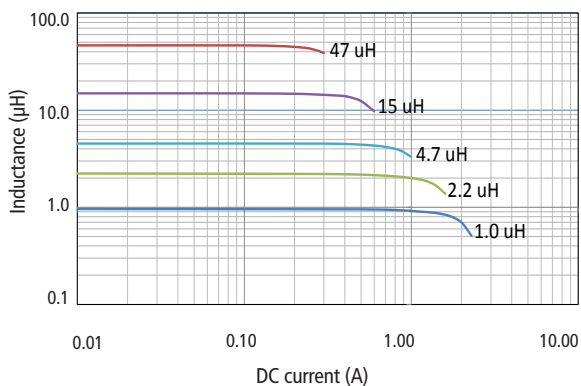

TYS3010 Temperature Rise vs DC Current

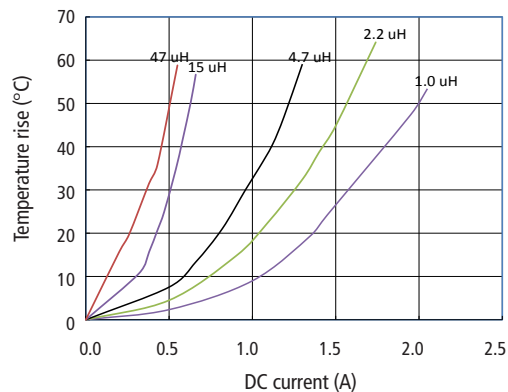

TYS3012 Typical L vs DC Current

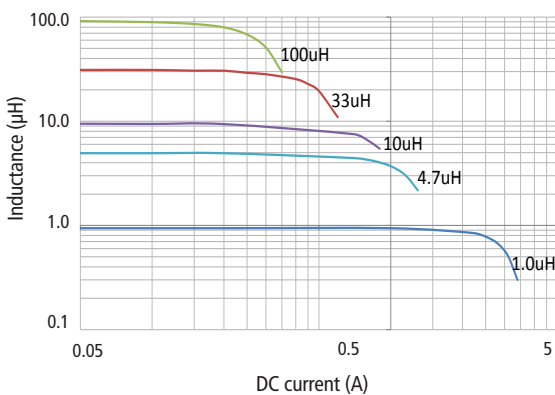

TYS3012 Temperature Rise vs DC Current

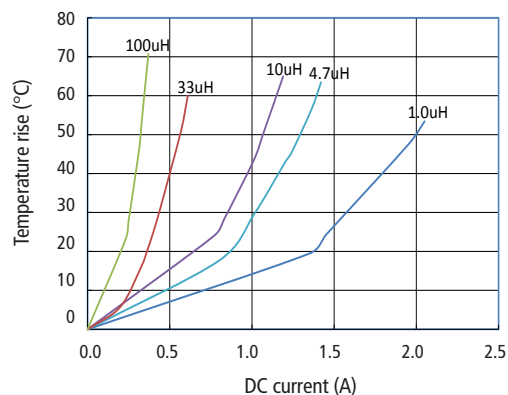

TYS3015 Typical L vs DC Current

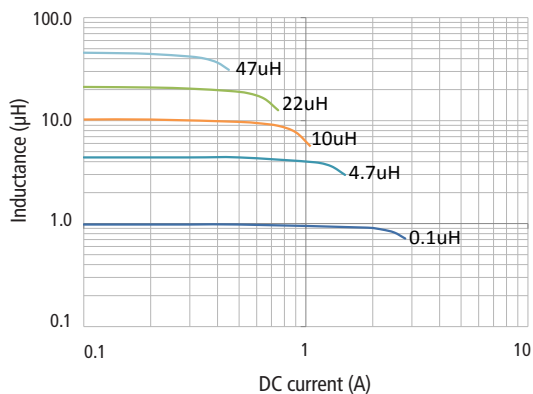

TYS3015 Temperature Rise vs DC Current

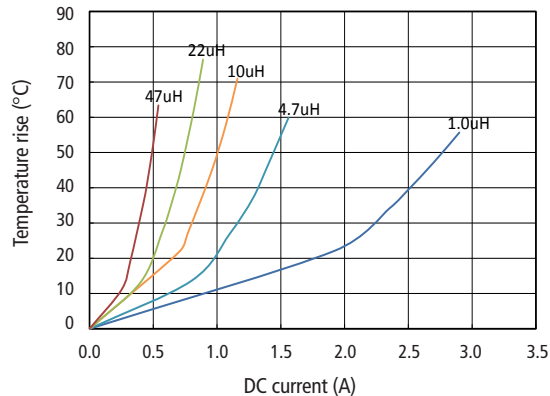

TYS SERIES 4012 / 4018 / 4020 / 4030

ELECTRICAL SPECIFICATIONS

PART NO.	INDUCTANCE (μH)	RDC (Ω) ± 30%	SATURATION CURRENT (A)	RMS CURRENT (A)	SRF MHZ (REF)
TYS40121R0N-10	1	0.050	2.61	1.65	120
TYS40122R2N-10	2.2	0.080	1.76	1.32	74
TYS40123R3N-10	3.3	0.110	1.72	1.12	60
TYS40124R7N-10	4.7	0.125	1.15	1.05	50
TYS40125R6N-10	5.6	0.140	1.00	1.00	42
TYS40126R8M-10	6.8	0.198	0.85	0.84	40
TYS4012100M-10	10	0.265	0.80	0.77	33
TYS4012150M-10	15	0.340	0.56	0.64	25
TYS4012220M-10	22	0.587	0.46	0.49	20
TYS4012330M-10	33	0.810	0.42	0.42	17
TYS4012470M-10	47	1.100	0.35	0.37	12
TYS4012680M-10	68	1.950	0.38	0.27	11
TYS4012101M-10	100	2.210	0.25	0.25	9.4
TYS40181R0N-10	1	0.025	4.80	2.00	80
TYS40182R2M-10	2.2	0.045	2.70	1.65	52
TYS40183R3M-10	3.3	0.070	2.45	1.23	44
TYS40184R7M-10	4.7	0.090	1.70	1.20	34
TYS40186R8M-10	6.8	0.110	1.45	1.06	29
TYS4018100M-10	10	0.180	1.30	0.84	24
TYS4018150M-10	15	0.250	0.94	0.65	19
TYS4018220M-10	22	0.360	0.80	0.59	16
TYS4018330M-10	33	0.530	0.65	0.49	12
TYS4018470M-10	47	0.650	0.57	0.42	10
TYS4018680M-10	68	1.000	0.47	0.32	8.3
TYS4018101M-10	100	1.750	0.40	0.25	6.5
TYS4018151M-10	150	2.500	0.31	0.22	5.5
TYS4018221M-10	220	4.000	0.27	0.17	4
TYS40201R0N-10	1	0.029	4.78	2.15	75
TYS40202R2N-10	2.2	0.040	3.40	1.85	49
TYS40203R3M-10	3.3	0.070	3.20	1.40	44
TYS40204R7M-10	4.7	0.075	2.35	1.34	42
TYS40206R8M-10	6.8	0.125	2.20	1.04	33
TYS4020100M-10	10	0.165	1.60	0.90	26
TYS4020150M-10	15	0.230	1.35	0.77	24
TYS4020220M-10	22	0.350	1.05	0.62	15
TYS4020330M-10	33	0.550	0.85	0.49	11
TYS4020470M-10	47	0.710	0.74	0.44	10
TYS4020680M-10	68	1.060	0.61	0.36	7.7
TYS4020101M-10	100	1.550	0.48	0.31	6.3
TYS40301R0N-10	1	0.014	5.26	4.15	70
TYS40301R5N-10	1.5	0.020	4.84	3.34	62
TYS40302R2N-10	2.2	0.030	4.90	2.95	52
TYS40303R3M-10	3.3	0.040	3.30	2.40	38
TYS40304R7M-10	4.7	0.060	2.90	2.00	31
TYS40306R8M-10	6.8	0.090	2.75	1.60	24
TYS4030100M-10	10	0.100	1.95	1.50	21
TYS4030150M-10	15	0.190	1.65	1.11	16
TYS4030220M-10	22	0.225	1.30	1.00	10
TYS4030330M-10	33	0.330	1.10	0.84	10
TYS4030470M-10	47	0.490	0.95	0.72	8.4
TYS4030680M-10	68	0.868	0.72	0.52	7
TYS4030101M-10	100	1.150	0.60	0.45	5.6
TYS4030121M-10	120	1.350	0.55	0.42	5.4

TYS SERIES 4012 / 4018 / 4020 / 4030

TYPICAL ELECTRICAL CHARACTERISTICS

TYS4012 Typical L vs DC Current

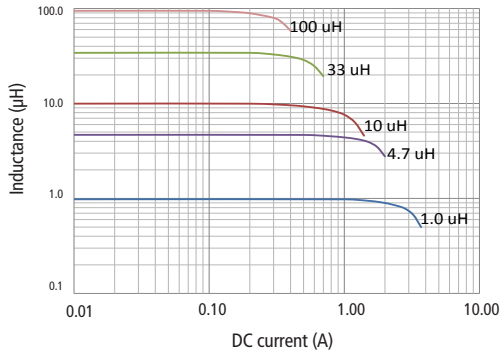

TYS4012 Temperature Rise vs DC Current

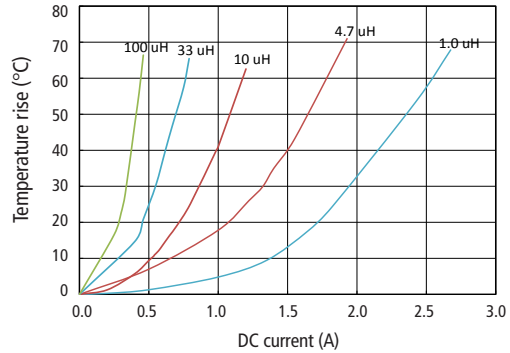

TYS4018 Typical L vs DC Current

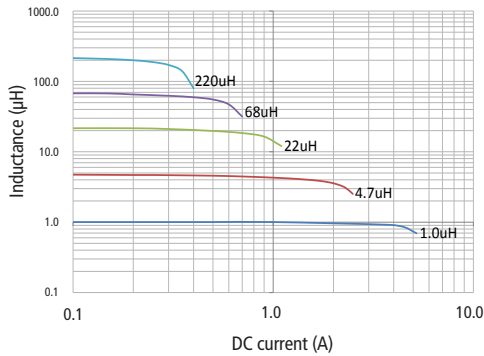

TYS4018 Temperature Rise vs DC Current

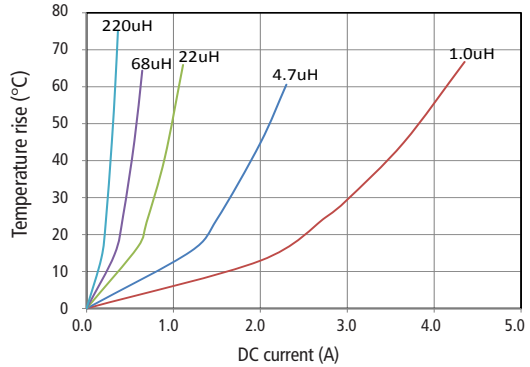

TYS4020 Typical L vs DC Current

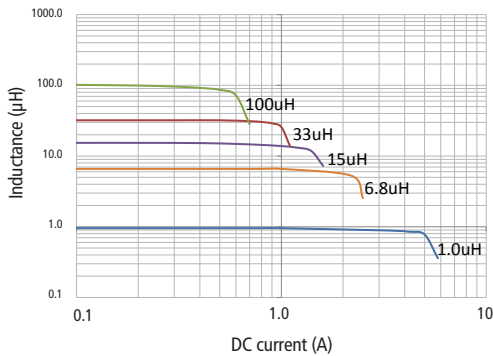

TYS4020 Temperature Rise vs DC Current

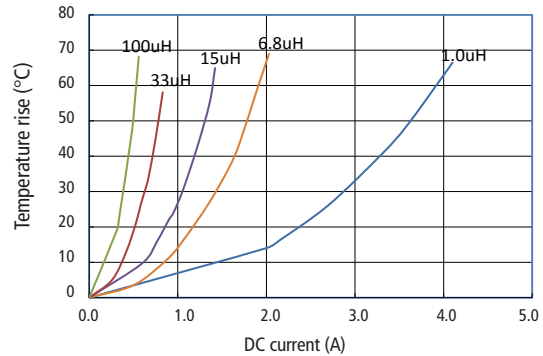

TYS4030 Typical L vs DC Current

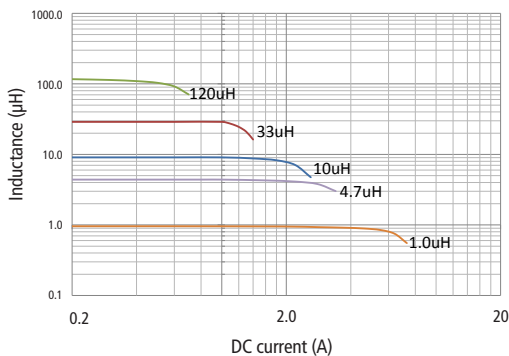

TYS4030 Temperature Rise vs DC Current

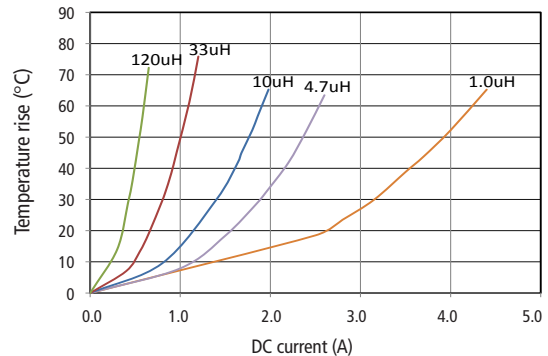

TYS SERIES 5020 / 5040

ELECTRICAL SPECIFICATIONS

PART NO.	INDUCTANCE (μ H)	RDC (Ω) \pm 30%	SATURATION CURRENT (A)	RMS CURRENT (A)	SRF MHZ (REF)
TYS50201R0N-10	1	0.020	4.10	3.80	114
TYS50201R5N-10	1.5	0.026	4.10	3.20	68
TYS50202R2N-10	2.2	0.032	3.20	2.90	57
TYS50203R3N-10	3.3	0.043	2.55	2.50	46
TYS50203R6N-10	3.6	0.043	2.80	2.50	43
TYS50204R7M-10	4.7	0.057	2.50	2.20	37
TYS50206R8M-10	6.8	0.083	2.05	1.80	30
TYS5020100M-10	10	0.110	1.70	1.55	24
TYS5020150M-10	15	0.165	1.35	1.25	20
TYS5020220M-10	22	0.226	1.15	1.10	14
TYS50401R5N-10	1.5	0.015	6.30	4.30	86
TYS50402R2N-10	2.2	0.019	4.90	3.80	50
TYS50403R3N-10	3.3	0.024	3.95	3.40	32
TYS50404R7N-10	4.7	0.030	3.50	3.00	28
TYS50406R8M-10	6.8	0.043	2.90	2.50	21
TYS5040100M-10	10	0.064	2.35	2.10	18
TYS5040150M-10	15	0.086	2.00	2.00	13
TYS5040220M-10	22	0.129	1.60	1.50	11
TYS5040330M-10	33	0.188	1.30	1.20	9.1
TYS5040470M-10	47	0.272	1.10	1.00	6.7
TYS5040680M-10	68	0.400	0.90	0.80	5.7
TYS5040101M-10	100	0.560	0.75	0.70	4.7

TYS SERIES 5020 / 5040

TYPICAL ELECTRICAL CHARACTERISTICS

TYS5020 Typical L vs DC Current

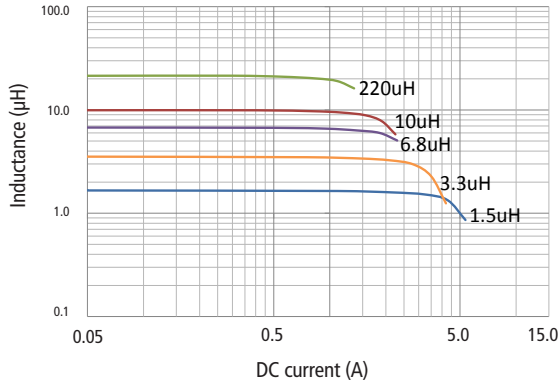

TYS5020 Temperature Rise vs DC Current

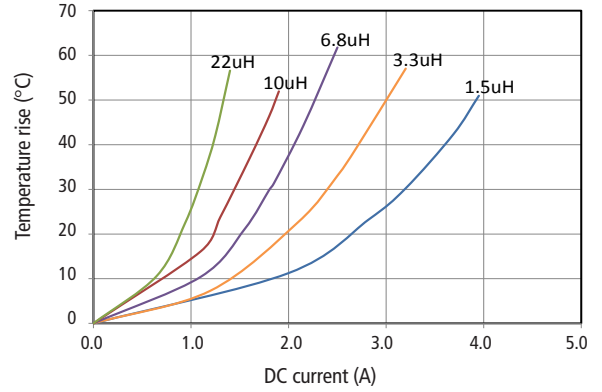

TYS5040 Typical L vs DC Current

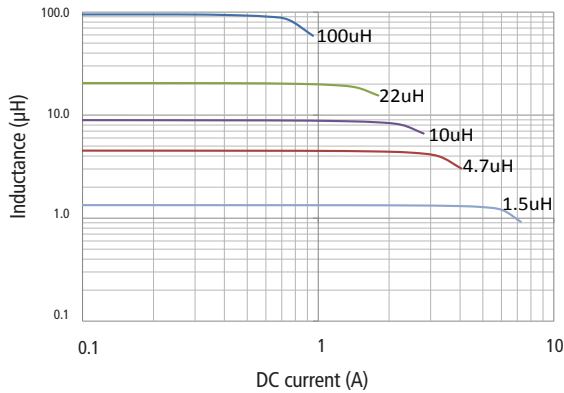

TYS5040 Temperature Rise vs DC Current

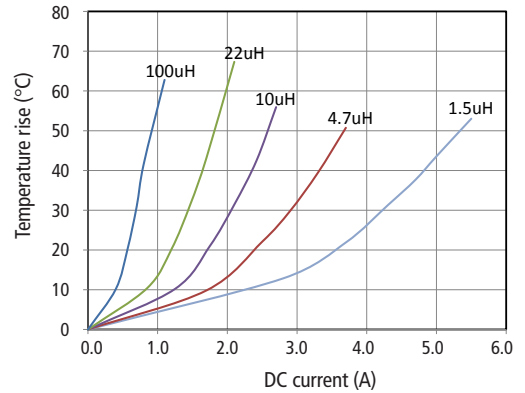

TYS SERIES 6020 / 6028 / 6045

ELECTRICAL SPECIFICATIONS

PART NO.	INDUCTANCE (μ H)	RDC ($\Omega \pm 30\%$)	SATURATION CURRENT (A)	RMS CURRENT (A)	SRF MHZ (REF)
TYS60201R0N-10	1	0.020	4.15	3.50	100
TYS60201R5N-10	1.5	0.022	4.25	3.20	79
TYS60202R2N-10	2.2	0.028	3.75	2.75	61
TYS60203R3N-10	3.3	0.035	3.15	2.60	51
TYS60204R7N-10	4.7	0.058	3.00	2.00	41
TYS60206R8N-10	6.8	0.079	2.20	1.80	31
TYS6020100M-10	10	0.105	1.75	1.40	27
TYS6020220M-10	22	0.204	1.05	1.00	16
TYS60281R0N-10	1	0.010	5.75	5.20	70
TYS60281R5N-10	1.5	0.013	6.00	4.58	65
TYS60282R2N-10	2.2	0.020	5.10	3.75	48
TYS60283R3N-10	3.3	0.025	4.15	3.48	41
TYS60284R7N-10	4.7	0.030	3.00	3.08	35
TYS60286R8M-10	6.8	0.047	2.60	2.40	27
TYS6028100M-10	10	0.072	2.04	1.95	23
TYS6028150M-10	15	0.125	1.75	1.45	18
TYS6028220M-10	22	0.140	1.45	1.40	14
TYS6028330M-10	33	0.185	1.35	1.22	12
TYS6028470M-10	47	0.315	1.15	1.06	9.5
TYS6028680M-10	68	0.360	0.80	0.86	7.7
TYS6028101M-10	100	0.500	0.65	0.70	7.1
TYS60451R0N-10	1	0.011	9.85	5.14	100
TYS60451R3N-10	1.3	0.010	8.35	5.40	100
TYS60451R5N-10	1.5	0.012	8.80	4.95	65
TYS60451R8N-10	1.8	0.012	7.60	4.95	74
TYS60452R2N-10	2.2	0.014	6.75	4.60	52
TYS60452R3N-10	2.3	0.021	6.00	3.50	60
TYS60453R0N-10	3	0.020	5.60	3.80	35
TYS60453R3N-10	3.3	0.021	5.90	3.70	32
TYS60454R5M-10	4.5	0.026	4.97	3.30	24
TYS60454R7M-10	4.7	0.026	4.97	3.30	24
TYS60456R3M-10	6.3	0.031	4.43	3.00	26
TYS60456R8M-10	6.8	0.031	3.90	3.00	20
TYS6045100M-10	10	0.048	3.20	2.45	15
TYS6045150M-10	15	0.068	2.50	2.05	12
TYS6045220M-10	22	0.089	2.05	1.80	10
TYS6045330M-10	33	0.137	1.65	1.45	7.8
TYS6045470M-10	47	0.200	1.40	1.20	6.4
TYS6045680M-10	68	0.289	1.20	1.00	6.4
TYS6045101M-10	100	0.433	0.95	0.80	4.2
TYS6045221M-10	220	0.834	0.70	0.59	3.5
TYS6045331M-10	330	1.270	0.57	0.57	2.8

TYS SERIES 6020 / 6028 / 6045

TYPICAL ELECTRICAL CHARACTERISTICS

TYS6020 Typical L vs DC Current

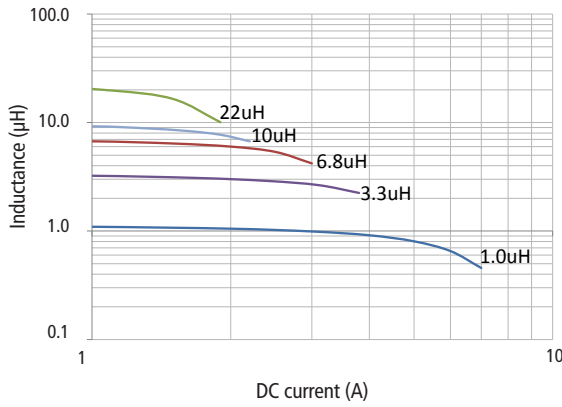

TYS6020 Temperature Rise vs DC Current

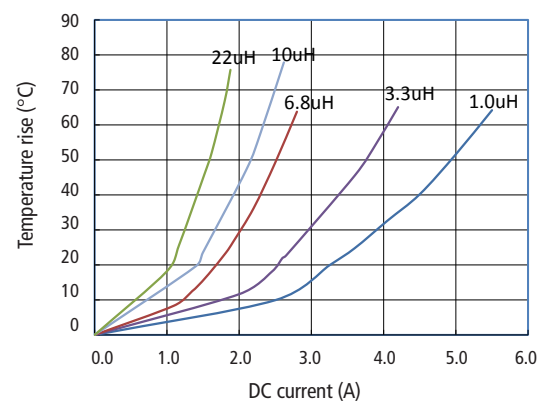

TYS6028 Typical L vs DC Current

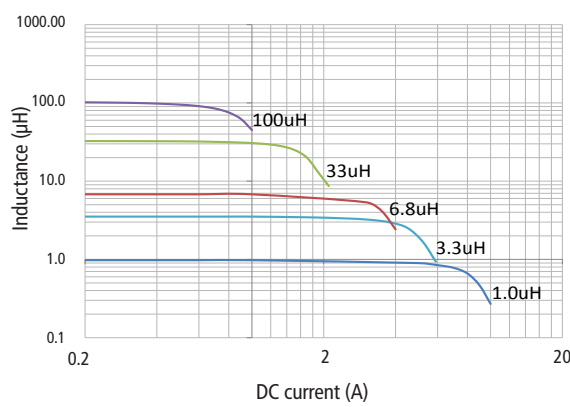

TYS6028 Temperature Rise vs DC Current

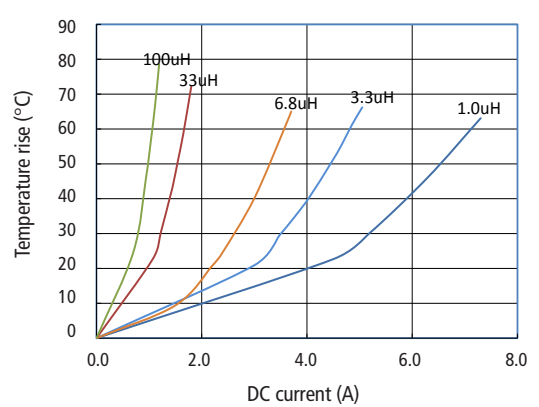

TYS6045 Typical L vs DC Current

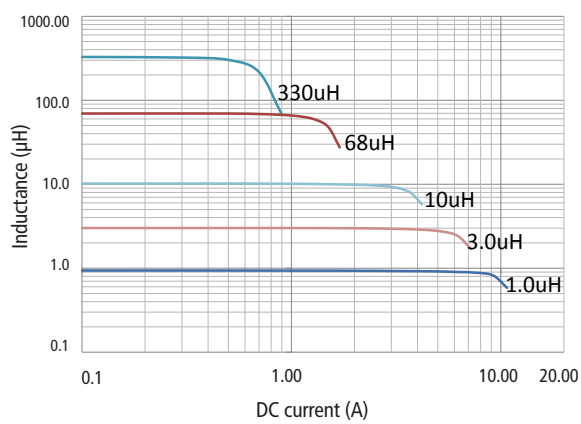

TYS6045 Temperature Rise vs DC Current

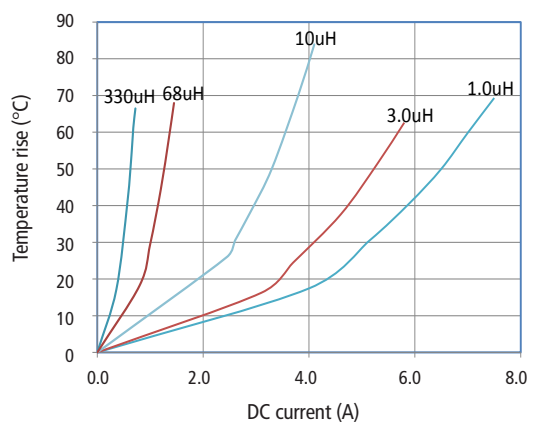

TYS SERIES 8040

ELECTRICAL SPECIFICATIONS

PART NO.	INDUCTANCE (μH)	RDC (Ω ± 30%)	SATURATION CURRENT (A)	RMS CURRENT (A)	SRF MHZ (REF)
TYS80401R0N-10	1	0.008	9.85	6.30	89
TYS80401R4N-10	1.4	0.010	8.15	5.65	67
TYS80402R0N-10	2	0.012	9.25	5.15	43
TYS80402R2N-10	2.2	0.012	7.10	5.15	41
TYS80403R3N-10	3.3	0.017	6.50	4.40	27
TYS80403R6N-10	3.6	0.017	7.52	4.35	30
TYS80404R7N-10	4.7	0.019	5.90	4.10	24
TYS80406R8M-10	6.8	0.024	4.55	3.60	20
TYS8040100M-10	10	0.029	3.60	3.30	15
TYS8040150M-10	15	0.047	2.95	2.60	12
TYS8040220M-10	22	0.069	2.40	2.10	9.5
TYS8040330M-10	33	0.097	2.05	1.80	7.8
TYS8040470M-10	47	0.136	1.75	1.55	6.4
TYS8040680M-10	68	0.196	1.45	1.25	4.9
TYS8040101M-10	100	0.290	1.15	1.00	4.2
TYS8040151M-10	150	0.410	1.10	0.85	3.5
TYS8040221M-10	220	0.599	0.85	0.80	3.5
TYS8040331M-10	330	0.889	0.68	0.64	2.8

TYPICAL ELECTRICAL CHARACTERISTICS

TYS8040 Typical L vs DC Current

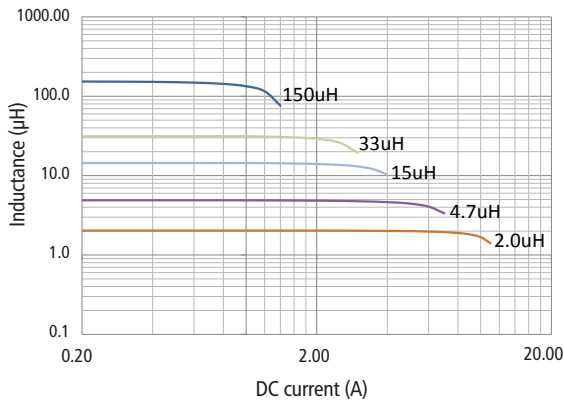

TYS8040 Temperature Rise vs DC Current

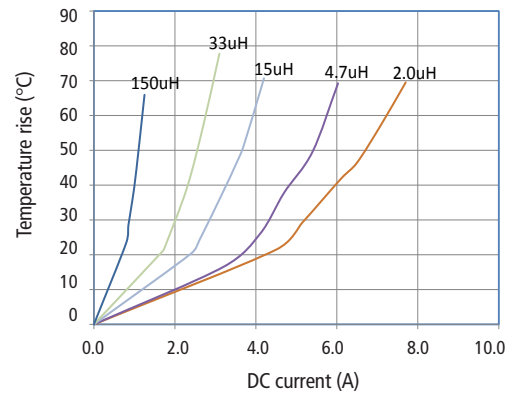

TEMPERATURE PROFILE OF REFLOW SOLDERING

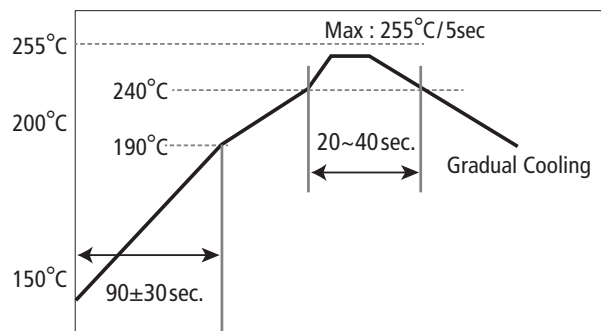

TYS SERIES PACKAGING INFORMATION

STANDARD QUANTITY

SERIES	TAPE AND REEL QUANTITY (PCS)
TYS252010L	2000
TYS252012L	2000
TYS3010	2000
TYS3012	2000
TYS3015	2000
TYS4012	4500
TYS4018	3000
TYS4020	3000
TYS4030	2000
TYS5020	2500
TYS5040	1500
TYS6020	2500
TYS6028	2000
TYS6045	1500
TYS8040	1000

TAPING DIMENSIONS

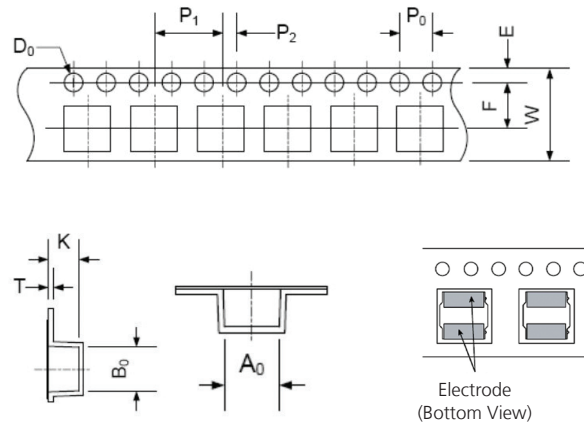

SERIES (UNIT: mm)	A_0	B_0	F	K	T	D_0	P_0	P_1	P_2	W	E
TYS252010L	2.35±0.05	2.65±0.05	3.5±0.05	1.2±0.05	0.25±0.03	1.5+0.1/-0	4±0.1	4±0.1	2±0.1	8±0.3	1.75±0.1
TYS252012L				1.4±0.1							
TYS3010	1.6±0.1										
TYS3012	3.3±0.1	3.3±0.1	1.9±0.1	0.35±0.03	8±0.1			12±0.3			
TYS3015	4.3±0.1	4.3±0.1	5.5±0.05						1.4±0.1		
TYS4012			2.1±0.1								
TYS4018			2.4±0.1								
TYS4020	5.5±0.1	5.5±0.1	3.2±0.1	0.4±0.03	16±0.3						
TYS4030			2.2±0.1								
TYS5020			2.5±0.1								
TYS5040	5.4±0.1	5.4±0.1	4.2±0.1	0.4±0.03	12±0.1						
TYS6020	6.3±0.1	6.3±0.1	3.3±0.1								
TYS6028	6.4±0.1	6.4±0.1	4.7±0.1								
TYS6045	7.5±0.1	7.5±0.1	4.4±0.1								
TYS8040	8.35±0.1	8.35±0.1									

REEL DIMENSIONS

SERIES (UNIT: mm)	A	W1	W2	B	C	D	E
TYS252010L	178±2.0	8.4+1.5/-0.0	<14.4	58±2.0	2.45±0.2	/	13.5±0.2
TYS252012L							
TYS3010							
TYS3012							
TYS3015							
TYS4012	330	12.4+0.2/-0.0	<18.4	100	2.30±0.2	10.75±0.2	13.0+0.2/-0
TYS4018							
TYS4020							
TYS4030							
TYS5020							
TYS5040							
TYS6020							
TYS6028	16.4+0.2/-0.0	<22.4					
TYS6045							
TYS8040							

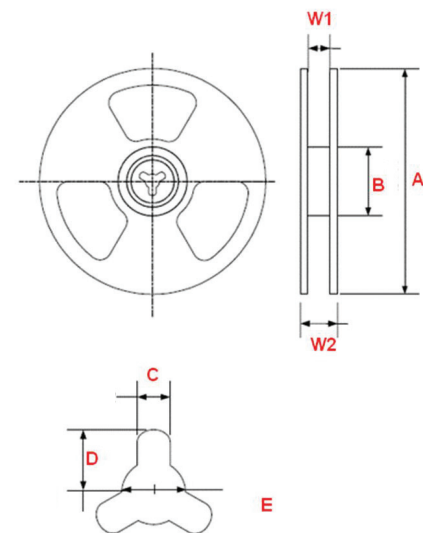

SAMPLE KIT LISTS

KIT NO:K-510 TYS IND

It contains parts of each single series as following lists

SERIES	PART NUMBER QTY	SAMPLE QTY / PN
TYS252010	9	5
TYS252012	10	5
TYS3010	11	5
TYS3012	13	5
TYS3015	11	5
TYS4012	13	5
TYS4018	14	5
TYS4020	12	5
TYS4030	14	5
TYS5020	10	5
TYS5040	12	5
TYS6020	8	5
TYS6028	13	5
TYS6045	21	5
TYS8040	18	3

NOTES



Americas: +1 800 634.2673 Option 1

Europe: +420 488.575277

Asia: +86 757.2563.8860

www.lairdtech.com

A 7D-CAT-TYS SERIES \$+\$*%*

Any information furnished by Laird Technologies, Inc. and its agents is believed to be accurate and reliable. All specifications are subject to change without notice. Responsibility for the use and application of Laird Technologies materials rests with the end user. Laird Technologies makes no warranties as to the fitness, merchantability, suitability or non-infringement of any Laird Technologies materials or products for any specific or general uses. Laird Technologies shall not be liable for incidental or consequential damages of any kind. All Laird Technologies products are sold pursuant to the Laird Technologies' Terms and Conditions of sale in effect from time to time, a copy of which will be furnished upon request. © Copyright 2016 Laird Technologies, Inc. All Rights Reserved. Laird, Laird Technologies, the Laird Technologies Logo, and other marks are trade marks or registered trade marks of Laird Technologies, Inc. or an affiliate company thereof. Other product or service names may be the property of third parties. Nothing herein provides a license under any Laird Technologies or any third party intellectual property rights. Version A02