

## Ultra Fast NPT - IGBT® with Ultra Soft Recovery Diode

The Ultra Fast 650V NPT-IGBT® family of products is the newest generation of IGBTs optimized for outstanding ruggedness and best trade-off between conduction and switching losses.

### Features

- Low Saturation Voltage
- Low Tail Current
- RoHS Compliant 
- Smooth Reverse Recovery
- Short Circuit Withstand Rated
- High Frequency Switching
- Ultra Low Leakage Current
- Snap-free Switching

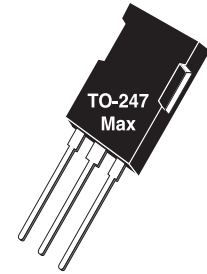

Combi (IGBT and Diode)



Unless stated otherwise, Microsemi discrete IGBTs contain a single IGBT die. This device is recommended for applications such as induction heating (IH), motor control, general purpose inverters and uninterruptible power supplies (UPS).

### MAXIMUM RATINGS

All Ratings:  $T_C = 25^\circ\text{C}$  unless otherwise specified.

Symbol	Parameter	Ratings	Unit
$V_{CES}$	Collector Emitter Voltage	650	V
$V_{GE}$	Gate-Emitter Voltage	$\pm 30$	
$I_{C1}$	Continuous Collector Current @ $T_C = 25^\circ\text{C}$	118	A
$I_{C2}$	Continuous Collector Current @ $T_C = 110^\circ\text{C}$	56	
$I_{CM}$	Pulsed Collector Current <sup>①</sup>	224	
SCWT	Short Circuit Withstand Time: $V_{CE} = 325V, V_{GE} = 15V, T_C = 125^\circ\text{C}$	10	$\mu\text{s}$
$P_D$	Total Power Dissipation @ $T_C = 25^\circ\text{C}$	543	W
$T_J, T_{STG}$	Operating and Storage Junction Temperature Range	-55 to 150	$^\circ\text{C}$
$T_L$	Max. Lead Temp. for Soldering: 0.063" from Case for 10 Sec.	300	

### STATIC ELECTRICAL CHARACTERISTICS

Symbol	Parameter	Min	Typ	Max	Unit
$V_{(BR)CES}$	Collector-Emitter Breakdown Voltage ( $V_{GE} = 0V, I_C = 350\mu\text{A}$ )	650			Volts
$V_{GE(TH)}$	Gate Threshold Voltage ( $V_{CE} = V_{GE}, I_C = 2.5\text{mA}, T_J = 25^\circ\text{C}$ )	3.5	5.0	6.5	
$V_{CE(ON)}$	Collector-Emitter On Voltage ( $V_{GE} = 15V, I_C = 45A, T_J = 25^\circ\text{C}$ )		1.9	2.4	
	Collector-Emitter On Voltage ( $V_{GE} = 15V, I_C = 45A, T_J = 125^\circ\text{C}$ )		2.4		
	Collector-Emitter On Voltage ( $V_{GE} = 15V, I_C = 90A, T_J = 25^\circ\text{C}$ )		2.6		
$I_{CES}$	Collector Cut-off Current ( $V_{CE} = 650V, V_{GE} = 0V, T_J = 25^\circ\text{C}$ ) <sup>②</sup>		20	350	$\mu\text{A}$
	Collector Cut-off Current ( $V_{CE} = 650V, V_{GE} = 0V, T_J = 125^\circ\text{C}$ ) <sup>②</sup>		200		
$I_{GES}$	Gate-Emitter Leakage Current ( $V_{GE} = \pm 20V$ )			$\pm 250$	nA



**CAUTION: These Devices are Sensitive to Electrostatic Discharge. Proper Handling Procedures Should Be Followed.**

# DYNAMIC CHARACTERISTICS

APT45GR65B2DU30

Symbol	Parameter	Test Conditions	Min	Typ	Max	Unit
$C_{ies}$	Input Capacitance	Capacitance $V_{GE} = 0V, V_{CE} = 25V$ $f = 1MHz$		2900		pF
$C_{oes}$	Output Capacitance			548		
$C_{res}$	Reverse Transfer Capacitance			268		
$V_{GEP}$	Gate to Emitter Plateau Voltage	Gate Charge		7.5		V
$Q_g^{(3)}$	Total Gate Charge	$V_{GE} = 15V$		150	203	nC
$Q_{ge}$	Gate-Emitter Charge	$V_{CE} = 325V$		18	24	
$Q_{gc}$	Gate- Collector Charge	$I_C = 45A$		74	100	
$t_{d(on)}$	Turn-On Delay Time	Inductive Switching (25°C) $V_{CC} = 433V$ $V_{GE} = 15V$ $I_C = 45A$		15		ns
$t_r$	Current Rise Time			32		
$t_{d(off)}$	Turn-Off Delay Time			100		
$t_f$	Current Fall Time			50		
$E_{on2}^{(5)}$	Turn-On Switching Energy	$R_G = 4.3\Omega^{(4)}$		1100	1650	μJ
$E_{off}^{(6)}$	Turn-Off Switching Energy	$T_J = +25^\circ C$		540	870	
$t_{d(on)}$	Turn-On Delay Time	Inductive Switching (125°C) $V_{CC} = 433V$ $V_{GE} = 15V$ $I_C = 45A$		15		ns
$t_r$	Current Rise Time			32		
$t_{d(off)}$	Turn-Off Delay Time			123		
$t_f$	Current Fall Time			52		
$E_{on2}^{(5)}$	Turn-On Switching Energy	$R_G = 4.3\Omega^{(4)}$		1600	2400	μJ
$E_{off}^{(6)}$	Turn-Off Switching Energy	$T_J = +125^\circ C$		800	1160	

# THERMAL AND MECHANICAL CHARACTERISTICS

Symbol	Characteristic	Min	Typ	Max	Unit
$R_{\theta JC}$	Junction to Case Thermal Resistance (IGBT)			0.23	°C/W
	Junction to Case Thermal Resistance (Diode)			0.80	
$R_{\theta JA}$	Junction to Ambient Thermal Resistance			40	
$W_T$	Package Weight		0.22		oz
			6.2		g

- 1 Repetitive Rating: Pulse width and case temperature limited by maximum junction temperature.
  - 2 Pulse test: Pulse Width < 380μs, duty cycle < 2%.
  - 3 See Mil-Std-750 Method 3471.
  - 4  $R_G$  is external gate resistance, not including internal gate resistance or gate driver impedance. (MIC4452)
  - 5  $E_{on2}$  is the energy loss at turn-on and includes the charge stored in the freewheeling diode.
  - 6  $E_{off}$  is the clamped inductive turn-off energy measured in accordance with JEDEC standard JESD24-1.
- Microsemi reserves the right to change, without notice, the specifications and information contained herein.

# TYPICAL PERFORMANCE CURVES

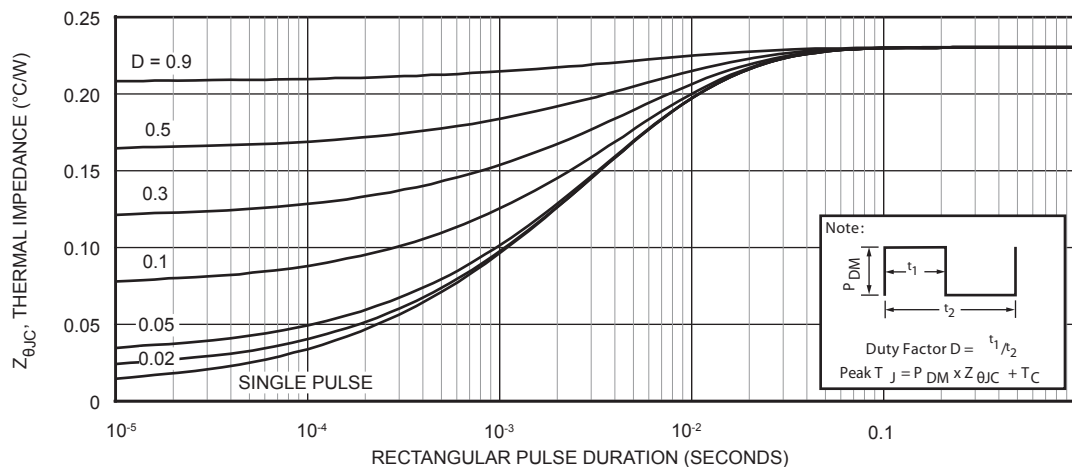

FIGURE 1, Maximum Effective Transient Thermal Impedance, Junction-To-Case vs Pulse Duration

# TYPICAL PERFORMANCE CURVES

APT45GR65B2DU30

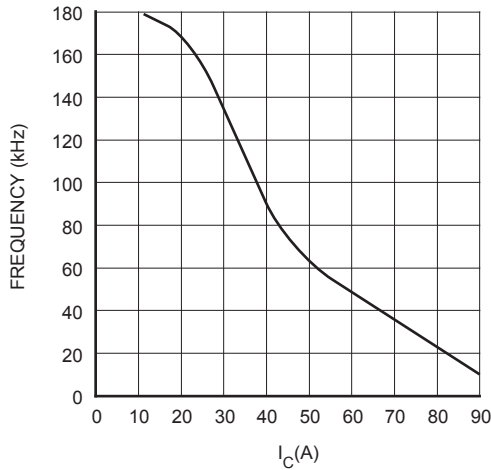

FIGURE 2, Max Frequency vs Current ( $T_{case} = 75^{\circ}C$ )

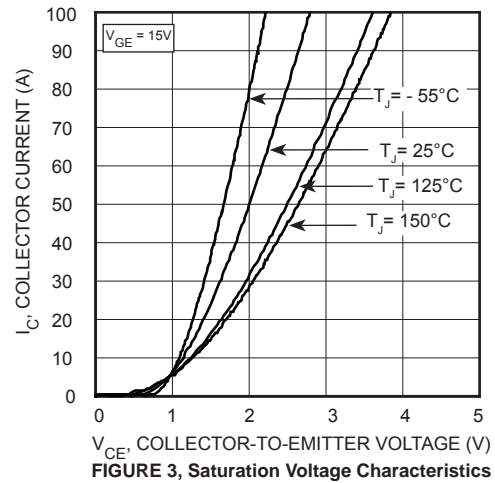

FIGURE 3, Saturation Voltage Characteristics

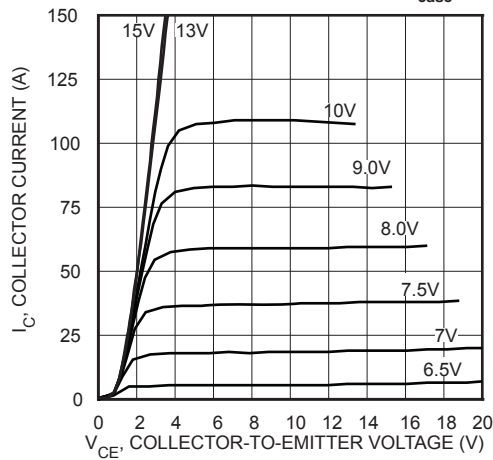

FIGURE 4, Output Characteristics ( $T_J = 25^{\circ}C$ )

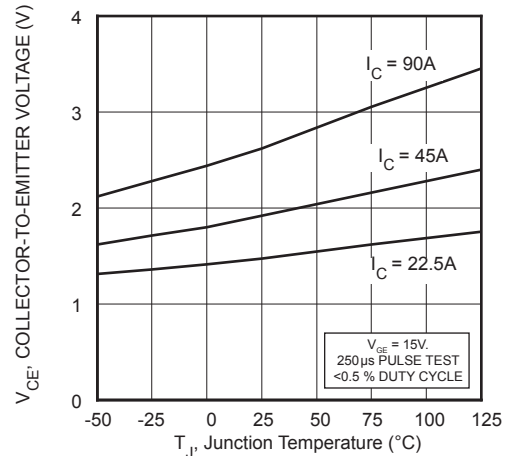

FIGURE 5, On State Voltage vs Junction Temperature

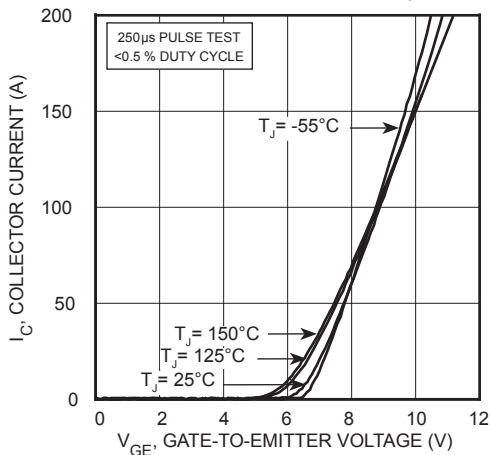

FIGURE 6, Transfer Characteristics

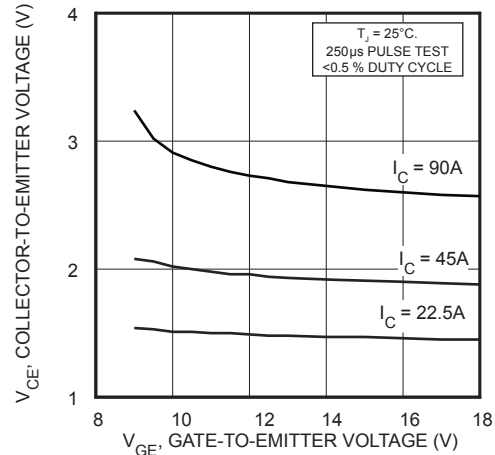

FIGURE 7, On State Voltage vs Gate-to-Emitter Voltage

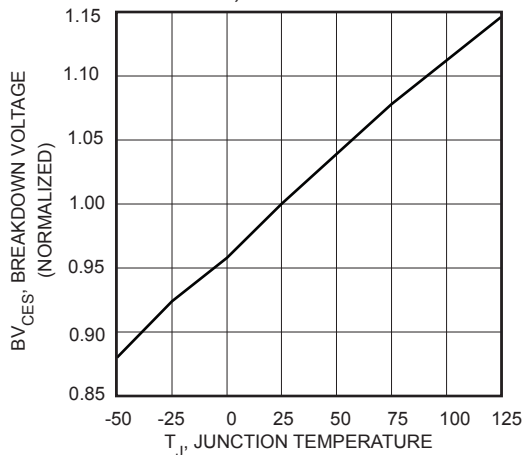

FIGURE 8, Breakdown Voltage vs Junction Temperature

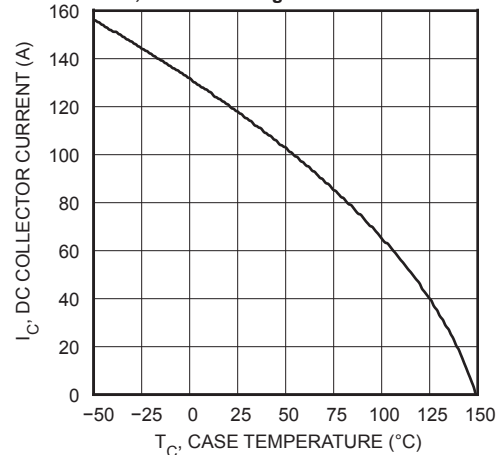

FIGURE 9, DC Collector Current vs Case Temperature

TYPICAL PERFORMANCE CURVES

APT45GR65B2DU30

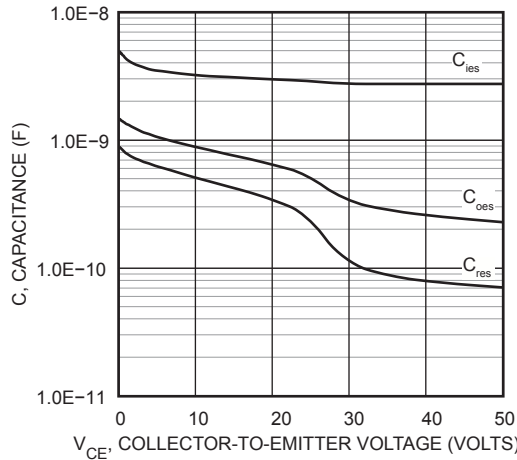

FIGURE 10, Capacitance vs Collector-To-Emitter Voltage

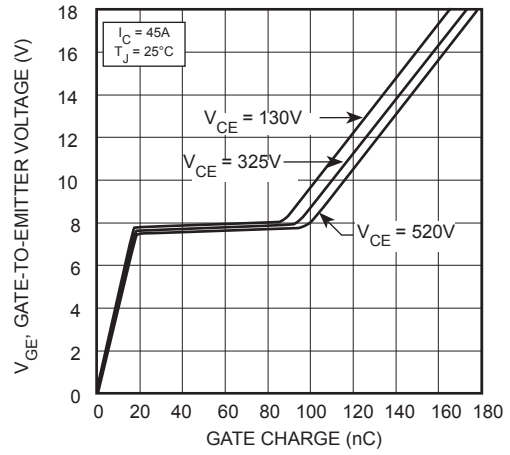

FIGURE 11, Gate charge

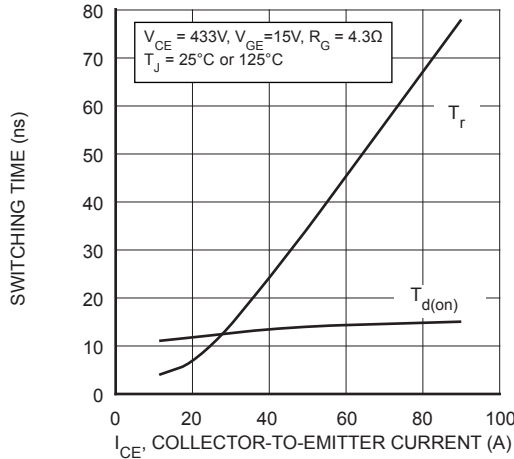

FIGURE 12, Turn-On Time vs Collector Current

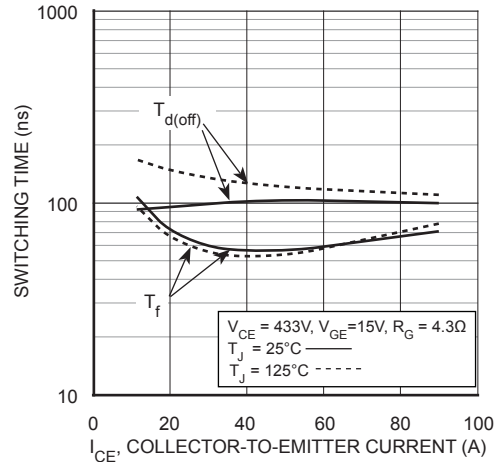

FIGURE 13, Turn-Off Time vs Collector Current

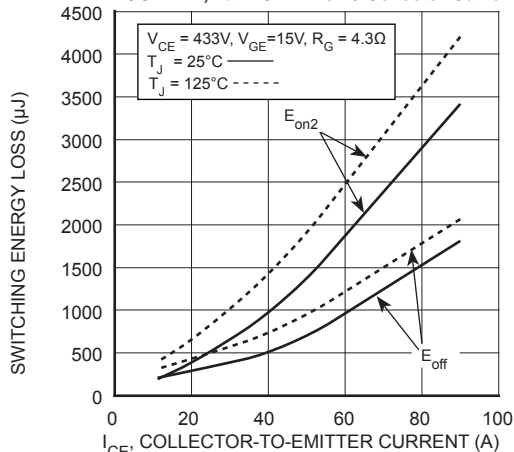

FIGURE 14, Energy Loss vs Collector Current

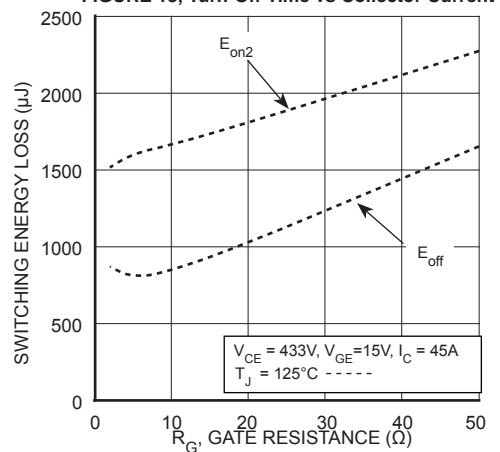

FIGURE 15, Energy Loss vs Gate Resistance

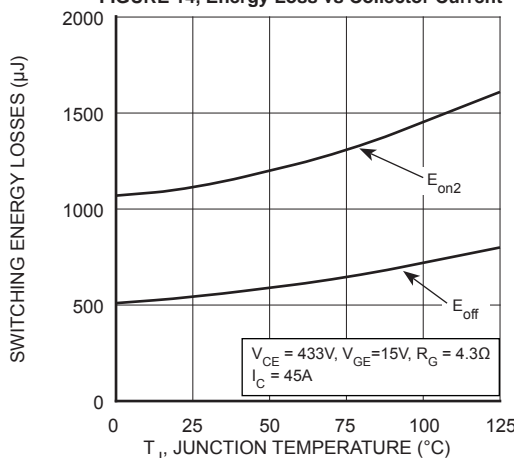

FIGURE 16, Switching Energy vs Junction Temperature

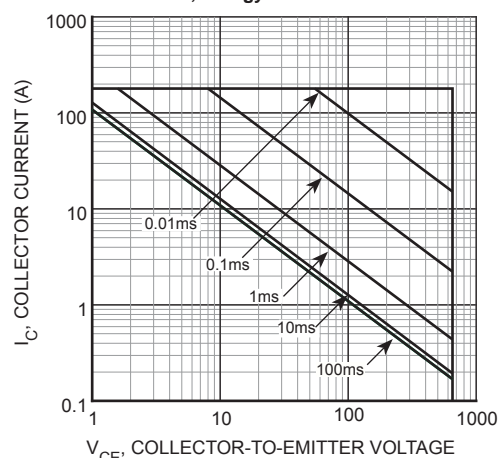

FIGURE 17, Minimum Switching Safe Operating Area

# ULTRA SOFT RECOVERY ANTI-PARALLEL DIODE

## MAXIMUM RATINGS

All Ratings:  $T_C = 25^\circ\text{C}$  unless otherwise specified.

Symbol	Characteristic / Test Conditions	APT45GR65B2DU30	Unit
$I_{F(AV)}$	Maximum Average Forward Current ( $T_C = 82^\circ\text{C}$ , Duty Cycle = 0.5)	30	Amps
$I_{F(RMS)}$	RMS Forward Current (Square wave, 50% duty)	41	
$I_{FSM}$	Non-Repetitive Forward Surge Current ( $T_J = 45^\circ\text{C}$ , 8.3ms)	210	

## STATIC ELECTRICAL CHARACTERISTICS

Symbol	Characteristic / Test Conditions	Min	Typ	Max	Unit
$V_F$	Forward Voltage		$I_F = 30\text{A}$	3	Volts
			$I_F = 60\text{A}$	3.9	
			$I_F = 60\text{A}, T_J = 125^\circ\text{C}$	3.5	

## DYNAMIC CHARACTERISTICS

Symbol	Parameter	Test Conditions	Min	Typ	Max	Unit
$t_{rr}$	Reverse Recovery Time	$I_F = 1.0\text{A}, \text{dif}/\text{dt} = -100 \text{ A}/\mu\text{s}, V_R = 30\text{V}, T_J = 25^\circ\text{C}$		28		ns
$t_{rr}$	Reverse Recovery Time	$I_F = 30 \text{ Amps}$ $\text{dif}/\text{dt} = -200 \text{ A}/\mu\text{s}$ $V_R = 433 \text{ Volts}$ $T_J = 25^\circ\text{C}$		80		ns
$Q_{rr}$	Reverse Recovery Charge			110		nC
$I_{RRM}$	Maximum Reverse Recovery Current			3		Amps
$E_{rr}$	Reverse Recovery Energy			2		$\mu\text{J}$
$t_{rr}$	Reverse Recovery	$I_F = 30 \text{ Amps}$ $\text{dif}/\text{dt} = -200 \text{ A}/\mu\text{s}$ $V_R = 433 \text{ Volts}$ $T_J = 125^\circ\text{C}$		343		ns
$Q_{rr}$	Reverse Recovery Charge			965		nC
$I_{RRM}$	Maximum Reverse Recovery Current			7		Amps
$E_{rr}$	Reverse Recovery Energy			88		$\mu\text{J}$
$t_{rr}$	Reverse Recovery	$I_F = 30 \text{ Amps}$ $\text{dif}/\text{dt} = -1000 \text{ A}/\mu\text{s}$ $V_R = 433 \text{ Volts}$ $T_J = 125^\circ\text{C}$		124		ns
$Q_{rr}$	Reverse Recovery Charge			1355		nC
$I_{RRM}$	Maximum Reverse Recovery Current			24		Amps
$E_{rr}$	Reverse Recovery Energy			211		$\mu\text{J}$
S	Softness Factor ( $t_b/t_a$ )	$I_F = 15\text{A}, \text{dif}/\text{dt} = -1000 \text{ A}/\mu\text{s}, V_R = 800\text{V}, T_J = 125^\circ\text{C}$		2		

## TYPICAL PERFORMANCE CURVES

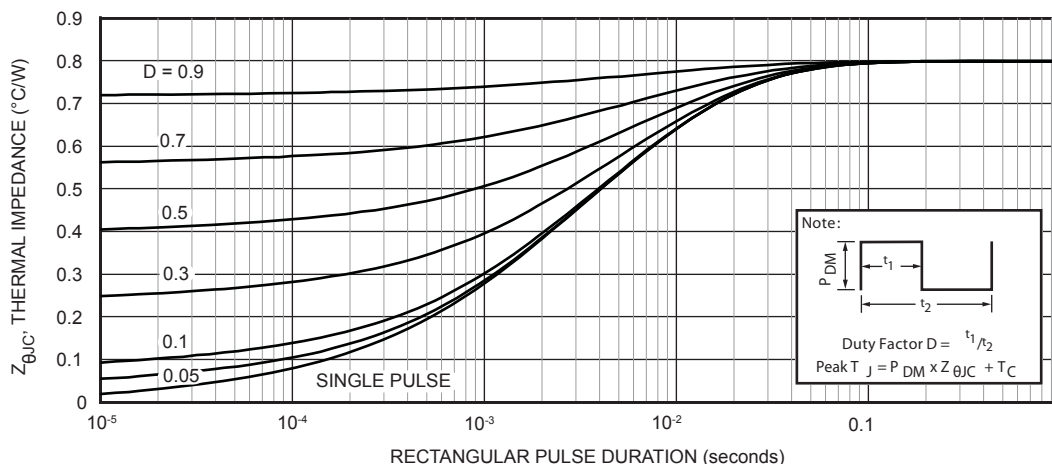

FIGURE 18, MAXIMUM EFFECTIVE TRANSIENT THERMAL IMPEDANCE, JUNCTION-TO-CASE vs. PULSE DURATION

# TYPICAL PERFORMANCE CURVES

APT45GR65B2DU30

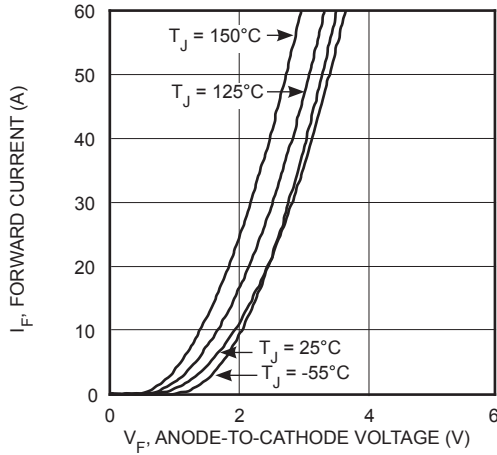

FIGURE 19, F Forward Current vs. Forward Voltage

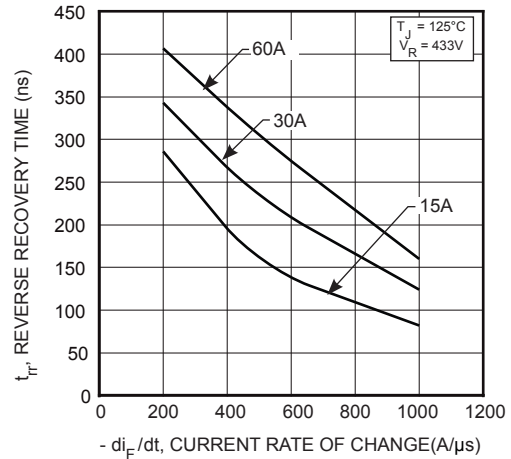

FIGURE 20, Reverse Recovery Time vs. Current Rate of Change

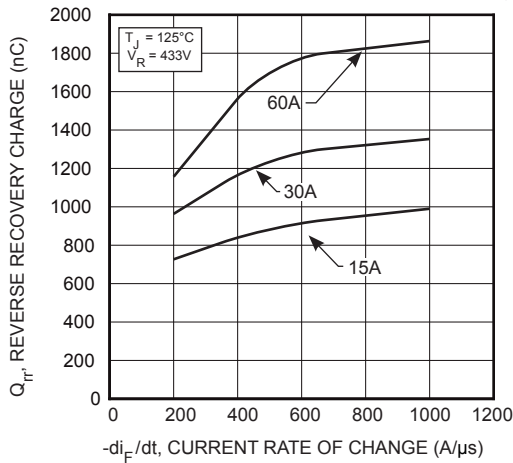

FIGURE 21, Reverse Recovery Charge vs. Current Rate of Change

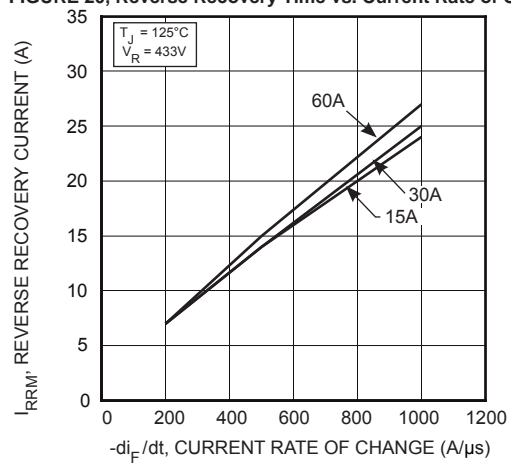

FIGURE 22, Reverse Recovery Current vs. Current Rate of Change

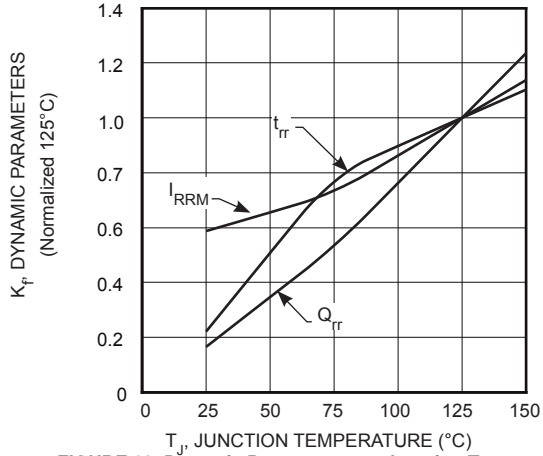

FIGURE 23, Dynamic Parameters vs. Junction Temperature

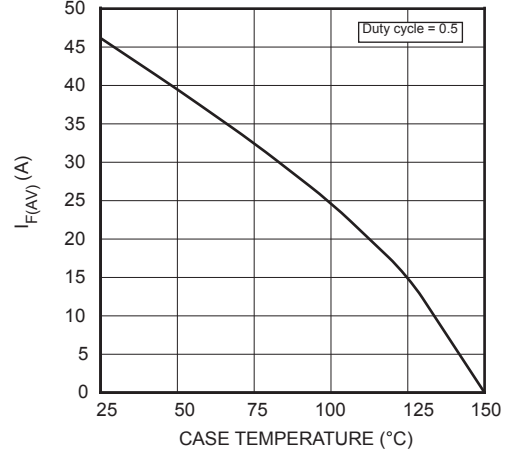

FIGURE 24, Max Average Forward Current vs. Case Temperature

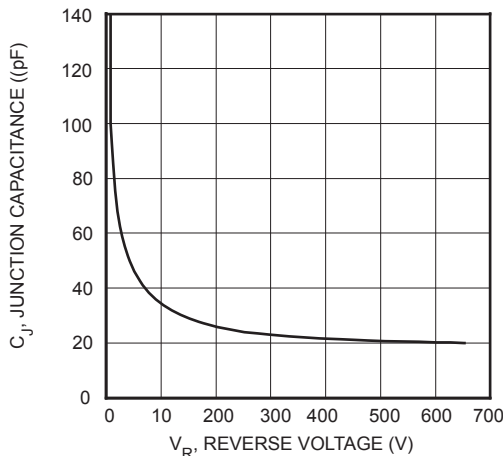

FIGURE 25, Junction Capacitance vs. Reverse Voltage

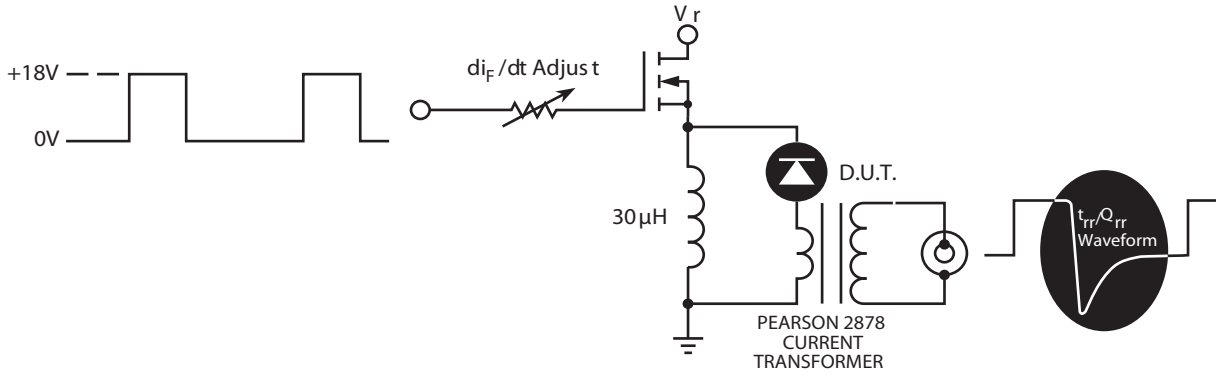

FIGURE 26, Diode Test Circuit

- 1  $I_F$  - Forward Conduction Current
- 2  $di_F/dt$  - Rate of Diode Current Change Through Zero Crossing
- 3  $I_{RRM}$  - Maximum Reverse Recovery Current
- 4  $t_a$  - Time to reach Maximum Reverse Recovery Current ( $I_{RRM}$ )
- 5  $t_b$  - Time from Maximum Reverse Recovery Current ( $I_{RRM}$ ) to projected zero crossing based on a straight line from  $I_{RRM}$  through 25%  $I_{RRM}$ .
- 6  $t_{rr}$  - Reverse Recovery Time measured from zero crossing where diode current goes from positive to negative, to the point at which the straight line through  $I_{RRM}$  and 0.25,  $I_{RRM}$  passes through zero
- 7  $Q_{rr}$  - Area Under the Curve Defined by  $I_{RRM}$  and  $t_{rr}$

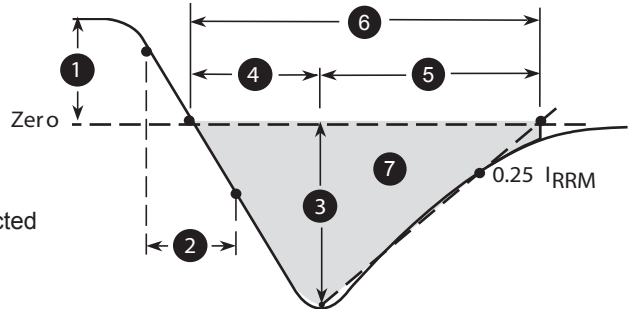
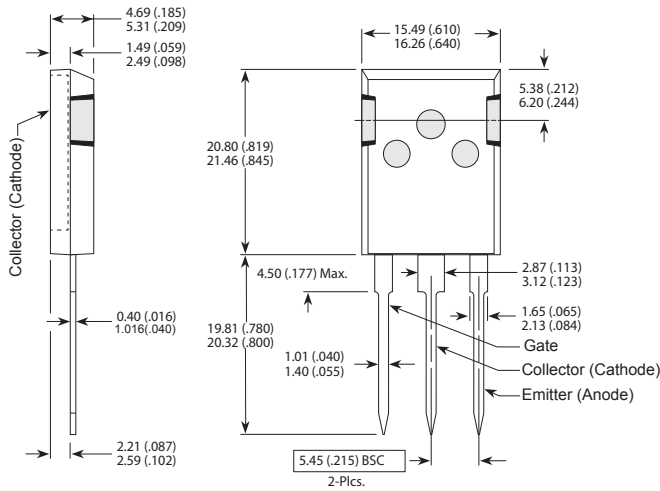

FIGURE 27, Diode Reverse Recovery Waveform Definition

**T-MAX<sup>®</sup> (B2) Package Outline**



These dimensions are equal to the TO-247 without the mounting hole.  
 Dimensions in Millimeters and (Inches)

**Disclaimer:**

The information contained in the document (unless it is publicly available on the Web without access restrictions) is PROPRIETARY AND CONFIDENTIAL information of Microsemi and cannot be copied, published, uploaded, posted, transmitted, distributed or disclosed or used without the express duly signed written consent of Microsemi. If the recipient of this document has entered into a disclosure agreement with Microsemi, then the terms of such Agreement will also apply. This document and the information contained herein may not be modified, by any person other than authorized personnel of Microsemi. No license under any patent, copyright, trade secret or other intellectual property right is granted to or conferred upon you by disclosure or delivery of the information, either expressly, by implication, inducement, estoppels or otherwise. Any license under such intellectual property rights must be approved by Microsemi in writing signed by an officer of Microsemi.

Microsemi reserves the right to change the configuration, functionality and performance of its products at anytime without any notice. This product has been subject to limited testing and should not be used in conjunction with life-support or other mission-critical equipment or applications. Microsemi assumes no liability whatsoever, and Microsemi disclaims any express or implied warranty, relating to sale and/or use of Microsemi products including liability or warranties relating to fitness for a particular purpose, merchantability, or infringement of any patent, copyright or other intellectual property right. Any performance specifications believed to be reliable but are not verified and customer or user must conduct and complete all performance and other testing of this product as well as any user or customer's final application. User or customer shall not rely on any data and performance specifications or parameters provided by Microsemi. It is the customer's and user's responsibility to independently determine suitability of any Microsemi product and to test and verify the same. The information contained herein is provided "AS IS, WHERE IS" and with all faults, and the entire risk associated with such information is entirely with the User. Microsemi specifically disclaims any liability of any kind including for consequential, incidental and punitive damages as well as lost profit. The product is subject to other terms and conditions which can be located on the web at <http://www.microsemi.com/terms-a-conditions>.