

MODEL:

PDUMNV30HV2

Monitored Rackmount PDU



**High Voltage
Input/Output**



L6-30P Plug



42 Outlets



**30A Max
Capacity**



**Multimode
Load Meter**

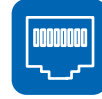

**Network
Interface**



0U Rackmount



**Toolless
Mounting
Buttons**

- A** Digital Load Meter
- B** C13 and C19 Outlets
- C** 15A Circuit Breakers
- D** Removable Cord Retention Brackets
- E** Removable Mounting Brackets
- F** Toolless Mounting Buttons with Removable 90° Rotation Brackets
- G** 10 ft. Input Power Cord
- H** L6-30P Twist-Lock Input Plug
- I** Durable Metal Case
- J** Network Interface
- K** RJ45 Ethernet Jack
- L** Manual Configuration Port
- M** Environmental Monitoring Port
- N** Network Interface Reset Button

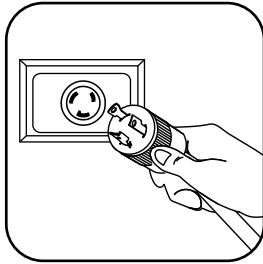

AC Input Connection: Insert L6-30P twist-lock plug into compatible L6-30R utility, generator or UPS outlet.

Also Includes: Cable Ties, Owner's Manual, PowerAlert Software CD-ROM

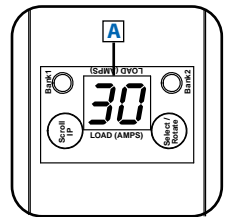
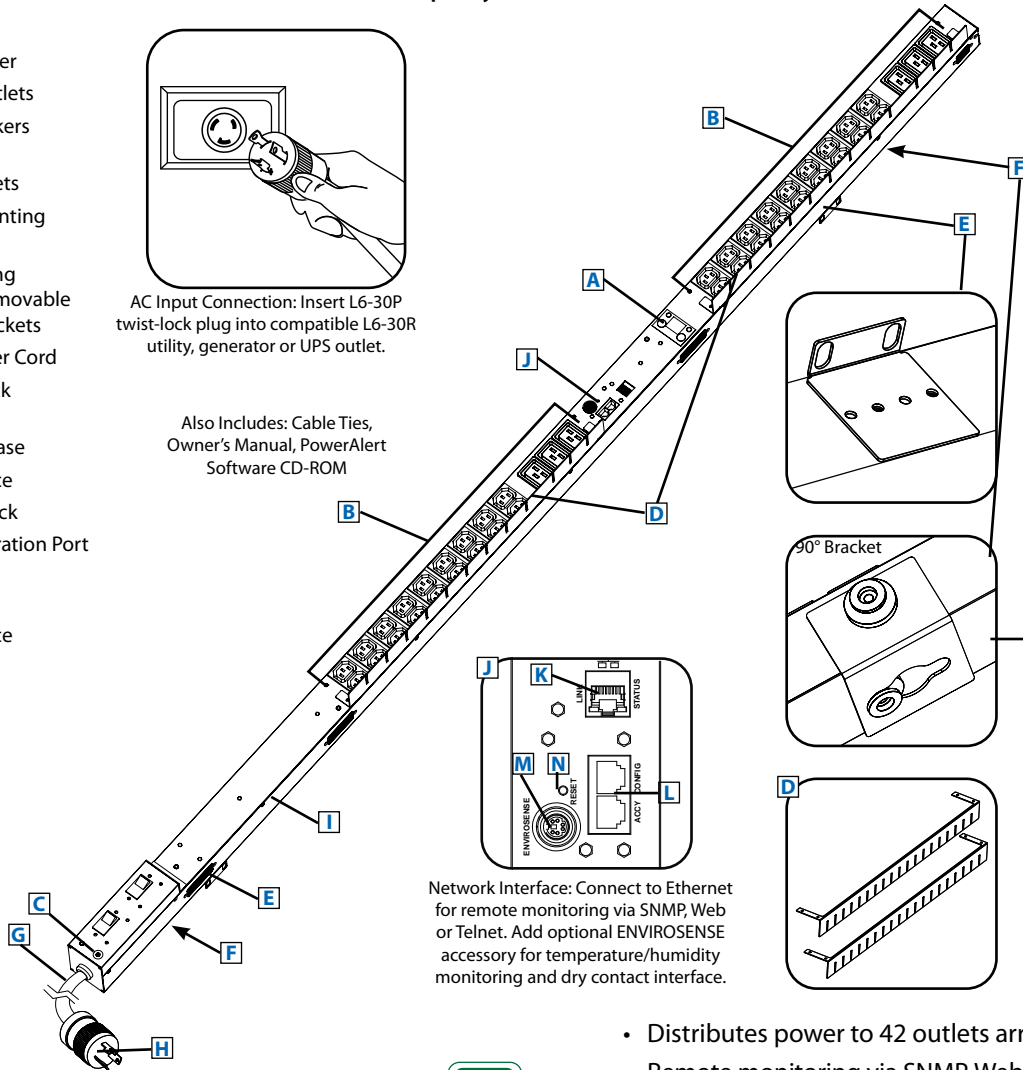

Multimode Load Meter: Press the "Select" button to switch modes—display the load for bank 1, bank 2 or both banks combined.

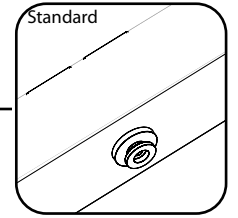
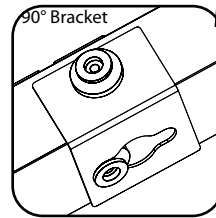
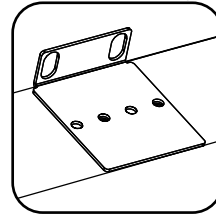

Note: Installed 17.67 mm toolless mounting buttons can be replaced with included 14.17 mm buttons for additional compatibility.

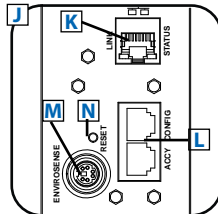

Network Interface: Connect to Ethernet for remote monitoring via SNMP, Web or Telnet. Add optional ENVIROSENSE accessory for temperature/humidity monitoring and dry contact interface.

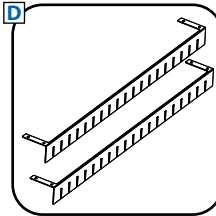

- Distributes power to 42 outlets arranged in two banks
- Remote monitoring via SNMP, Web or Telnet
- Displays load for either outlet bank or both banks combined in real time
- Perfect for rackmount server, network and telecom applications

SEE NEXT PAGE FOR DETAILED UNIT MEASUREMENTS



1111 W. 35th Street
Chicago, IL 60609 USA
773.869.1234
www.tripplite.com

Specifications

Model	PDUMNV30HV2
Voltage	208-240V
Frequency	50/60Hz
Maximum Capacity	30A
Agency-De-rated Capacity	24A
Input Connector	L6-30P
Cord Length	10 ft.
Outlets	42 (36 C13 / 6 C19)
Primary Mounting Option	0U (Vertical) Rackmount
Unit Weight & Dimensions	15 lbs / 70.5 x 2.2 x 2.65 in. <i>See next page for detailed unit measurements.</i>
Certifications	Tested to UL 60950-1 (US & Canada), NOM (Mexico), FCC Class A

Tripp Lite has a policy of continuous improvement. Specifications are subject to change without notice.



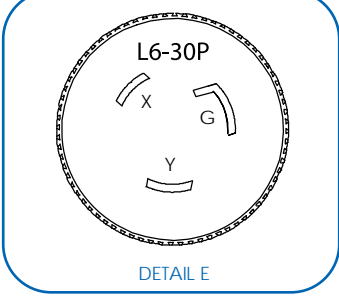
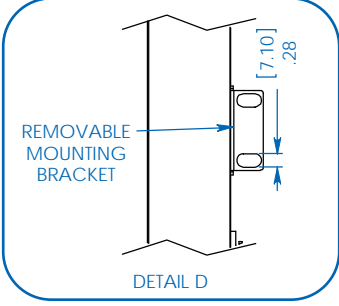
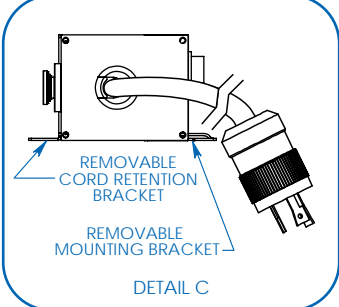
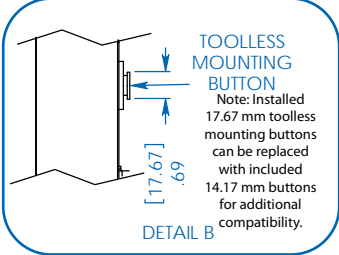
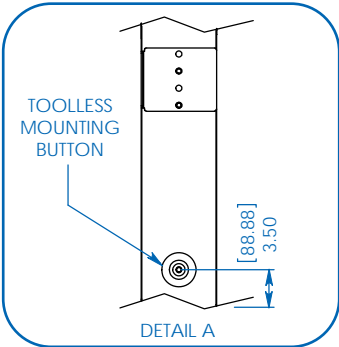
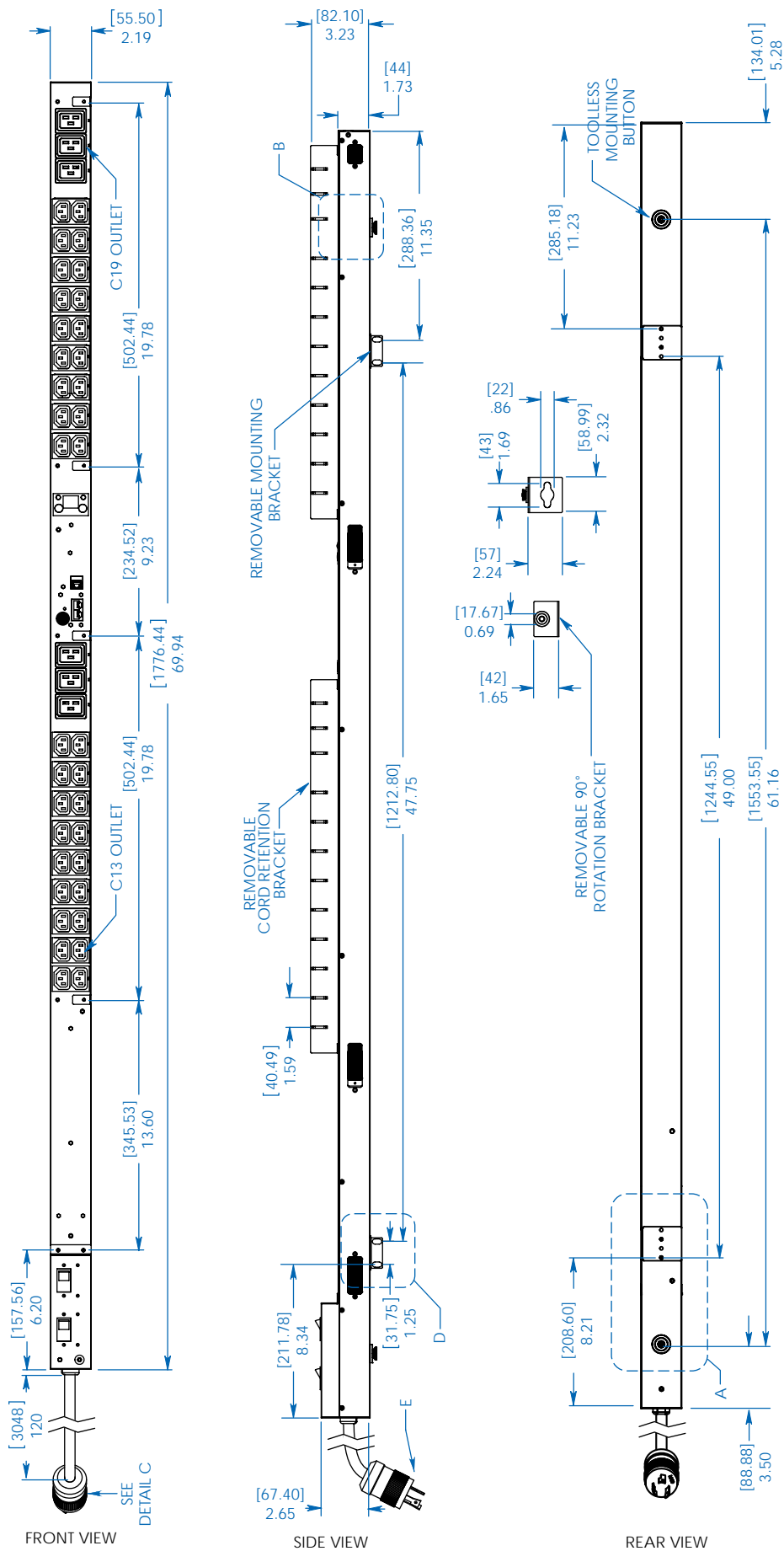

MODEL:
PDUMNV30HV2

TRIPP-LITE

1111 W. 35th Street
 Chicago, IL 60609 USA
 773.869.1234
 www.tripplite.com

Dimensions: [mm] INCHES

Tripp Lite has a policy of continuous improvement. Specifications are subject to change without notice.