

Energy Efficient Data Center Cabinet Systems



Net-Access™ Cabinet has tested compatible with Cisco Nexus 7018, MDS 9513, and Catalyst 6509. Go to www.panduit.com/cisco1 for disclaimer.

PANDUIT®

building a smarter,
unified business foundation
Connect. Manage. Automate.



Enhance Reliability. Overcome Thermal Challenges.

Data centers are mission-critical facilities and the nerve center of successful business operations. As more businesses are adopting consolidation, virtualization, and automation of networking assets to drive business results, a silo-based approach to designing, deploying and managing the physical infrastructure is becoming increasingly inadequate.

The growing interdependence of systems and applications, and the increased demands that they place on physical infrastructures, requires the integration of traditionally disparate and proprietary systems. This trend is dramatically changing infrastructure design, management strategies and effective synchronization of critical systems, opening the door for seamless convergence and interoperability of all core business systems.

Energy Efficient Data Center Cabinet Systems

Panduit draws from proven methodologies and global best practices to develop innovative, highly reliable and scalable physical infrastructure solutions. Panduit's switch, server, and storage equipment cabinet solutions significantly reduce total cost of ownership by increasing network availability, mitigating risk, and minimizing power consumption.

Both Panduit® Net-Access™ and new Net-SERV™ Cabinet Systems deliver energy efficiencies through shared thermal and cable management concepts.

Net-Access™ Cabinet System

Net-Access™ Switch and Server Cabinets have been optimized for higher density switch and server applications. Superior cable management, inset frame, and in-cabinet ducting options ensure proper airflow for improved network performance and availability.

Net-SERV™ Cabinet System

NEW Net-SERV™ Cabinets are designed to provide the best combination of space utilization and thermal management for server applications. Net-SERV™ Cabinets are designed to complement the Net-Access™ Cabinets and provide a complete, optimized physical infrastructure solution for all switch and server architectures.

Panduit's Unified Physical Infrastructure (UPI)

A unified approach to physical and logical systems architecture is imperative for solutions to fully address the need for availability, agility, integration, and security.

Panduit has developed the industry's most comprehensive and holistic approach to a Unified Physical Infrastructure and can help enterprises align, converge, and optimize critical systems – communication, computing, control, power, and security – to build a smarter, unified business foundation.

Mitigate Risk – Efficient physical infrastructure management enables seamless integration to reduce risks which can occur throughout core systems.

Lower Cost – Panduit physical infrastructure solutions drive financial advantages to reduce energy and occupancy costs, and help secure competitive advantage.

Increase Agility – A high level of integration within the physical infrastructure enables flexibility and improved business agility.

Enhance Sustainability – UPI-based solution offerings enable organizations to meet sustainability goals by driving resource and energy efficiencies across the physical infrastructure.

Unified Physical Infrastructure



communication computing control power security

Reduce Energy Costs 25% or More

Surging demand for processing power, work load virtualization and consolidation is increasing data center heat loads, making the thermal management of data centers challenging. Thermal issues that were once acceptable in a typical low-density data center are no longer tolerable in a high-density, high heat load environment:

- Hot air recirculation – exhaust is pulled back into equipment inlets
- Leakage – unintended hot/cold airflow paths
- Mixing of hot and cold air – results in a loss of cooling effectiveness
- Airflow obstructions – increased resistance to IT equipment fan airflow

Data center operators typically respond to these thermal issues in one or more of the following ways:

- Lower the supply air temperature set point on the cooling equipment
- Oversupply cool air by increasing the cooling equipment fan speed, increasing the amount of bypass air
- Run more cooling equipment than necessary, underutilizing available cooling capacity
- Oversize the cooling system to address isolated high-density regions

These responses are often ineffective and increase the capital and operational expenses by reducing the efficiency of the cooling system. However, by addressing the thermal issues at the root cause, data center operators can reduce energy costs while increasing thermal performance and efficiency.

Panduit's passive, optimized thermal management solutions enable high-density, high heat load data center designs while reducing energy costs of a typical data center by 25% or more.

Room Level Computational Fluid Dynamics Analysis of Data Center Thermal Characteristics

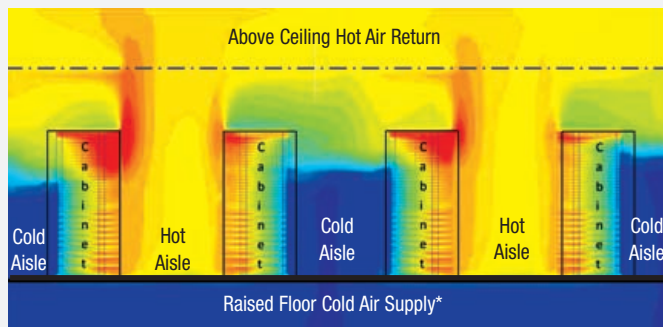

Typical Data Center

- Cool air does not reach the top portions of the cabinets, making servers in the top rack units vulnerable to overheating
- Hot exhaust air follows complex airflow path back to CRAH units
- Mixing of hot and cold air reduces the thermal efficiency of the cooling system

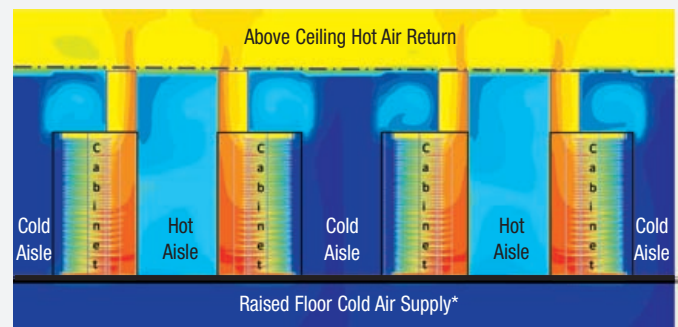

Data Center Utilizing Panduit Thermal Solutions

- Uniform distribution of cool air reaching the top of the cabinet
- Hot exhaust air is isolated and ducted directly to CRAH units
- Segregation of hot and cool air improves the overall thermal efficiency of the cooling system and makes the data center thermal environment more predictable and scalable

* Alternatively, in a slab environment, cold air can be supplied directly to the room.

Panduit Energy Efficient Cabinet Thermal Solutions

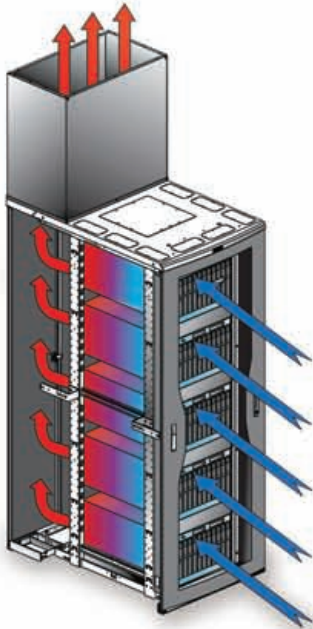

Panduit Energy Efficient Cabinets include innovative thermal solutions designed to maintain hot/cold air separation which enables improved cooling efficiency and reduced energy consumption.

- Vertical exhaust system to isolate hot exhaust air and duct it directly to CRAH units
- In-cabinet ducting solutions to properly direct cooling and exhaust airflows when network equipment has unconventional airflow patterns
- Integrated cable management solutions to enable optimized airflow and equipment performance
- Air sealing accessories to prevent leaks and enhance the utilization of cooling air

When combined with a well-designed cooling system, Panduit integrated cabinet thermal solutions can help reduce data center energy costs 25% or more.

Exhaust Containment for Efficient Cooling

The Panduit Vertical Exhaust System (VES) channels hot air from the cabinet directly into the ceiling plenum, eliminating hot air recirculation which can reduce energy consumption by allowing room and chilled water temperature set points to be raised. Studies have shown that each 1°C rise in chilled water temperature translates into a 3-4% energy savings. CapEx can be reduced by 16% through more effective use of cooling capacity.¹

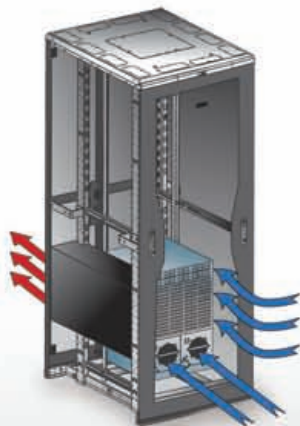

In-Cabinet Ducting Optimizes Cooling Air Flow

For network equipment that utilize side-to-side airflow patterns, in-cabinet ducting can be used to optimize cooling system efficiency by establishing front-to-back airflow patterns through the cabinet.

1) Each 1°C rise in chilled water temperature translates into 3-4% energy savings ¹ASHRAE 2005, Design Considerations for Datacom equipment Centers, American Society of Heating, Refrigeration, and Air Conditioning Engineers, ISBN 1-931862-94-X. Page 138.

Improved Cable Management Optimizes Air Flow

Panduit cabinets provide integral cable management, large pathways for routing and slacking cables, and vertically mounted patch panels and power outlet units (POUs). The integrated cable management positions cabling outside of equipment exhaust areas, minimizing airflow disruptions that could cause equipment overheating and failures.

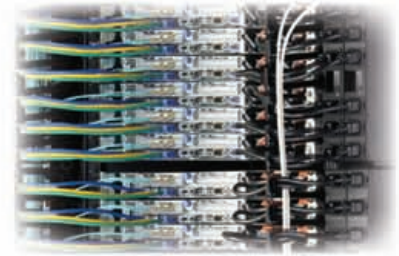

Sealing Accessories Boost Cooling Efficiency

Sealing accessories prevent the mixing of hot and cold air and increase thermal efficiency by eliminating leakage through cabinet and floor openings. Panduit® Cool Boot® Air Sealing Fittings seal off cable pass-through openings in the floor and the cabinet top minimizing leakage of air from the access floor and the cabinet.

Blanking panels seal empty rack spaces, eliminating the bypass of cooling air and recirculation of hot exhaust air maintaining hot and cold separation for improved efficiency.





Net-Access™ Cabinet System

Thermal Management and Cable Capacity for Switch and Server Applications

Net-Access™ Cabinets are the first choice for switch, server, and storage area network applications that require maximum thermal management capability, and the capacity to manage high cable densities.

Net-Access™ Switch Cabinet features include:

- In-cabinet ducting solutions to enable optimized airflow of switches with side-to-side airflow
- Large vertical pathways for high cable count applications
- Cable management fingers mount to front and back posts for maximum cabling configurations
- Dual hinge door for maximum accessibility between adjacent cabinets



Net-Access™ Server Cabinet features and options include:

- Vertical exhaust duct for optimal thermal performance
- Provides maximum cable management area and thermal performance
- Vertical patch panel configuration provides up to eight additional rack units in the same footprint
- Utilizes same platform as switch cabinet to enable maximum flexibility and deployment options

Net-Access™ Cabinet Applications

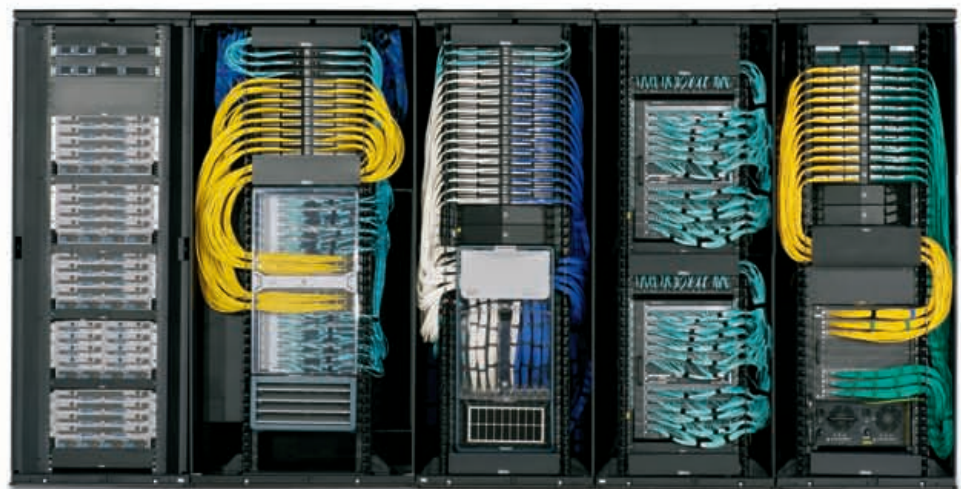

**UCS
Server**

**Nexus
7018**

**Nexus
7010**

**MDS
9513**

**Catalyst
6509**



Net-Access™ Switch Cabinets are compatible with Cisco^ Nexus 7018, MD9500 Series, and 6500 Series Switches.

Nexus 7018 and 7010 Applications are supported by Application Guides/Notes available at panduit.com.

Net-Access™ Cabinet Solution for Cisco^ Nexus 7018 Switch

Panduit offers a Net-Access™ Cabinet solution designed to meet the requirements of the Cisco Nexus 7018 Switch. The 1000mm (40") wide cabinet provides space to route and manage high densities of cables and provides required clearance for ducting to accommodate side to side cooling requirements.

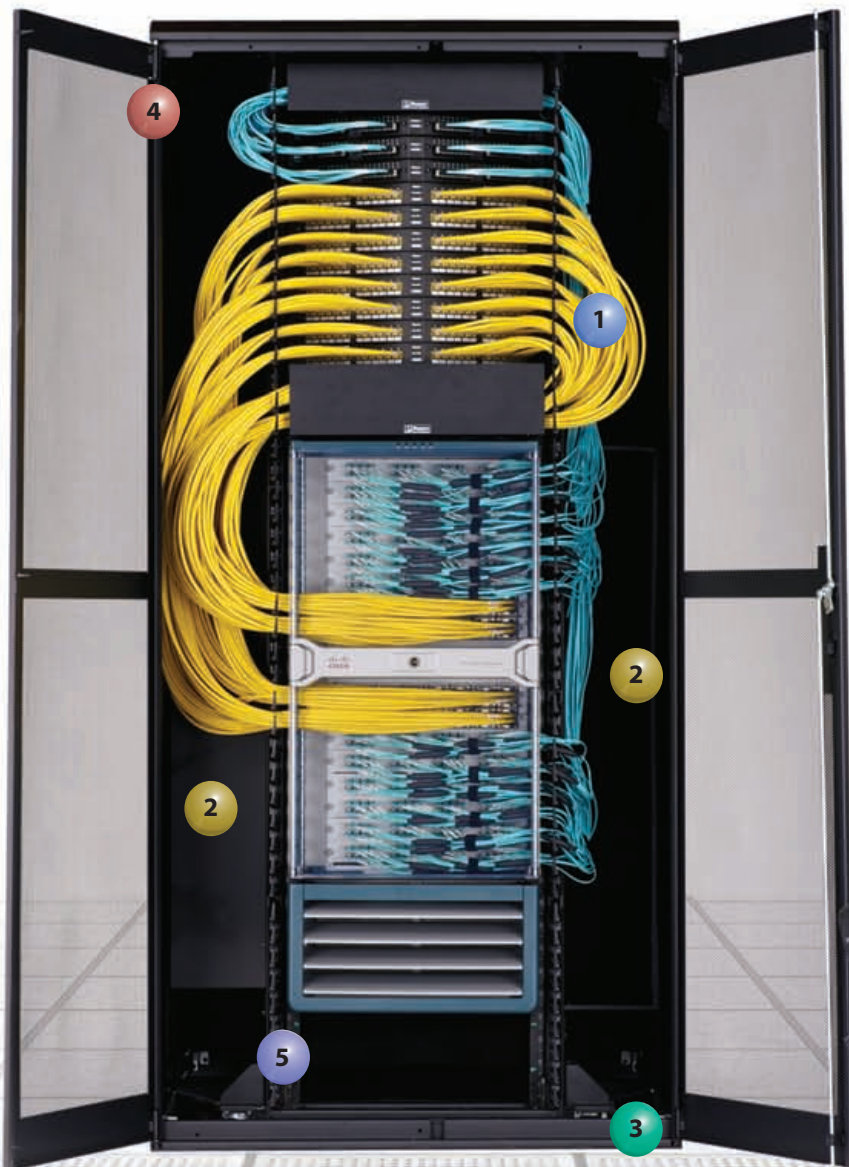

1 Cable Management

- Finger sections can be located where needed, on front and back of posts, to manage cables for greater routing flexibility
- Fingers align with rack spaces to ensure proper bend radius control and support cables as they transition to the vertical pathway



Cisco Nexus 7018 Cabinet - Complete solution consists of the following:

2 Air Duct Kit

- Exhaust and Inlet Ducts channel switch airflow to comply to hot aisle/cold aisle layouts
Part Number – **CNAE7018**



3 Cabinet Extension Kit

- Extends cabinet to 40" width and 48" depth to meet switch dimensional requirements
- Perforated split front and rear doors with lockable handles protect equipment and cables
Part Number – **CN7018-EXT**



4 Side Panel Kit

- Solid side panel is removable and lockable to provide security
* Covers one side of cabinet (two required per cabinet)
Part Number – **CNPS7018**

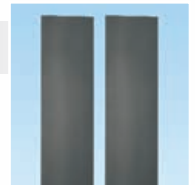

5 Cabinet

- Cabinet with two sets of #12-24 threaded equipment mounting rails. 45 RU cable management on front and rear of front posts.
Part Number – **CN3**



Net-Access™ Switch Cabinet Features

1 Large, Accessible Cable Pathways

- Vertical cable pathway design is optimized to provide unobstructed access to cabling for easy moves, adds, and changes



2 Dual Hinge Door

- Opens to the left and right enabling complete unobstructed access to adjacent cabinets and pathways



3 Cable Management

- Finger sections can be located where needed, on front and back of all four posts, to manage cables for greater routing flexibility
- Fingers align with rack spaces to ensure proper bend radius control and support cables as they transition to the vertical pathway



4 Thermal Management

- Inset cabinet frame posts and superior cable management ensure clear pathways and create a large area for airflow to provide proper heat dissipation
- Optional air ducts provide exhaust channels for equipment with high heat density applications



5 Grounding and Bonding

- Entire cabinet is fully electrically bonded, including equipment rails, doors, and side panels for protection of equipment and personnel
- StructuredGround™ Grounding System provides simple and convenient grounding for the entire cabinet



6 Routing Options for Overhead/Underfloor Cabling

- Knockouts in the top allow multiple options for overhead cable routing to provide flexibility and scalability
- Large bottom openings provide pathways for routing of cables from underfloor

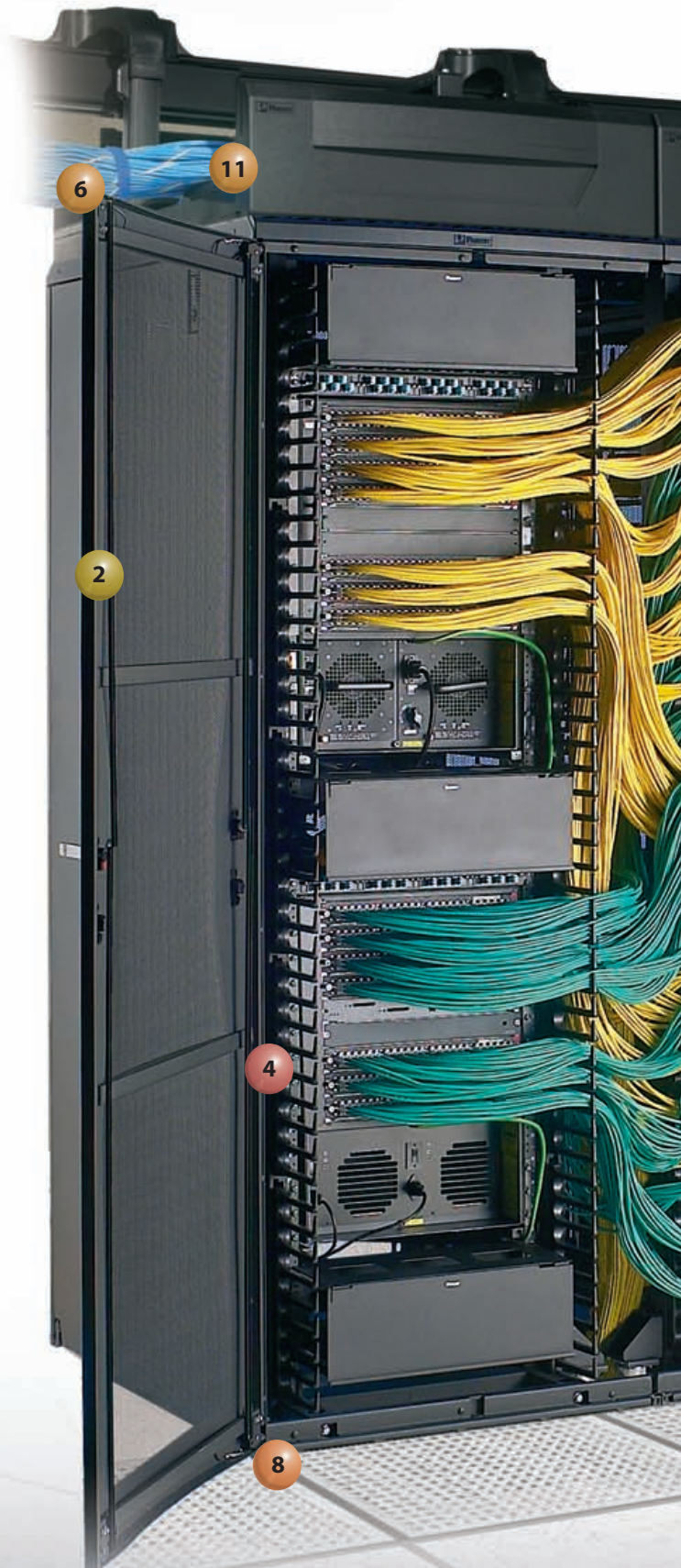
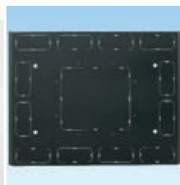



7 Adjustable Rails for Equipment Mounting

- Front and rear rails are easily and fully adjustable to accommodate a variety of equipment mounting requirements
- Printed rack space identification on rails provides for quick and easy installation of equipment
- Optional split rails provide flexibility for mounting of multiple equipment depths



8 Casters and Leveling Legs

- Optional casters mount to side of posts enabling safe, easy field installation or removal without tipping cabinet
- Leveling legs can be safely and easily adjusted without tipping the cabinet



9 Optional Side Cabinet Cable Management Brackets

- Allow mounting of 19" horizontal cable managers to provide pathway for routing cables from front-to-back of the cabinet
- Allow for mounting of cable strain relief bars to provide support for underfloor or overhead cabling



10 Optional Slack Spools

- Organize and manage patch cord slack allowing standardization of patch cord lengths
- Available in side mount for single cabinet or center mount for ganged applications to provide cable routing flexibility



Options and Accessories

11 Cabinet Top Air Sealing Fittings

- Optional air sealing fitting (CTG3X8) for routing and sealing copper cables entering the top of the cabinet. For use in 3" x 8" cabinet opening
- See page 27 for optional fiber optic fitting for routing and sealing fiber cables entering top of cabinet



12 CabRunner™ Overhead Cable Routing System

- Wide, molded design provides a high capacity pathway that is located directly on top of row of cabinets and does not need secondary mounting infrastructure
- Integral 3" (75mm) bend radius control protects cables from physical damage

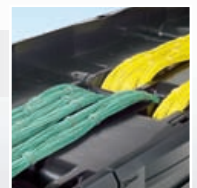

Net-Access™ Server Cabinet – Vertical Patch Panel Application

Vertical patch panels maximize rack space utilization for additional servers and other devices.

For 600mm (24") and 700mm (28") wide server cabinet solutions see pages 18-26.

1 Cable Management

- Fingers align with rack spaces to ensure proper bend radius control and support cables as they transition to the vertical pathway
- Finger sections can be located where needed to manage cables for greater routing flexibility



2 Thermal Management

- Cable management, inset cabinet frame, perforation patterns, and vertical blanking panels work together to ensure proper server airflow



3 Vertical Patch Panel Mounting

- Optional brackets allow for vertical mounting of up to four 1 RU EIA 19" copper or fiber patch panels to the side of the cabinet posts
- Aligns ports with rack spaces allowing standardization of patch cord lengths to reduce cable slack and provide superior thermal management



4 Power Outlet Unit Mounting

- Brackets are included to vertically mount POU's minimizing power cord lengths
- Universal features allow screw-on or tool-less mounting of Panduit or other POU's

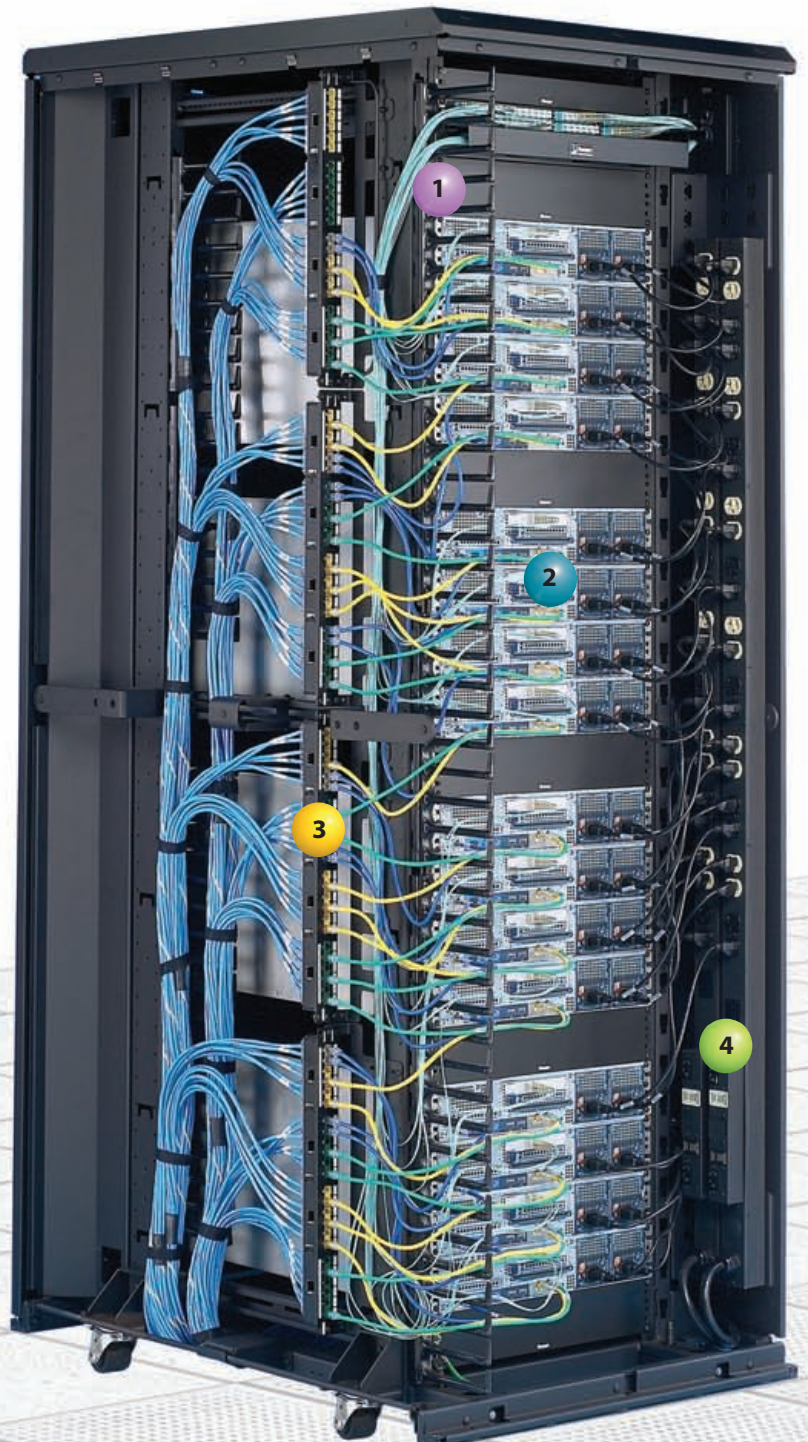

Net-Access™ Server Cabinet – Blade Server Application

Optional Vertical Exhaust System provides optimal thermal performance.

For 600mm (24") and 700mm (28") wide server cabinet solutions see pages 18-26.



1 Vertical Exhaust Duct

- Optional duct directs hot exhaust air to the plenum, enabling open area cooling efficiency



2 Cable Management

- Fingers align with rack spaces to ensure proper bend radius control and support cables as they transition to the vertical pathway
- Finger sections can be located where needed to manage cables for greater routing flexibility



3 Thermal Management

- Cable management, inset cabinet frame, perforation patterns, and vertical blanking panels work together to ensure proper server airflow

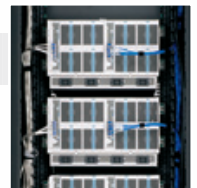

4 Power Outlet Unit Mounting

- Brackets are included to vertically mount POU's, minimizing power cord lengths
- Universal features allow screw-on or tool-less mounting of Panduit or other POU's





Net-Access™ Networked Power Outlet Units

Designed specifically for the Net-Access™ Cabinet, the Net-Access™ Vertical Power Outlet Unit maximizes power density and allows monitoring of power consumption via the network for improved network reliability.



Outlets align with rack units

- Vertical mounting does not occupy rack units
- Allows for standardization on optimal power cord lengths to reduce cord slack and congestion behind the equipment
- Plug retention device ensures a secure connection and provides a labeling location for power cord identification

High Power Density

- 30 Amps per power outlet unit
- Six power outlet units can be mounted on one side of the Net-Access™ Cabinet providing 90 Amps redundant power in the space of two traditional 66" vertical power outlet units

Monitor Power Consumption

- LED on unit displays voltage, current, power, and IP/MAC addresses
- Network connection allows remote monitoring and user definition of alarm traps and collection intervals via web access
- Daisy chain up to 50 power outlet units via an RJ-45 connection to a single switch port



Kit of (2) power cords and (2) plug retention devices for redundant power connections.

Part Number	Description	Std. Pkg. Qty.
PV12LN*	Vertical power strip 30 Amp, 240V, (12) IEC, C-13 receptacles, (2) 15 Amp magnetic breakers, 10' power cord with NEMA L6-30P twist lock plug, cTUVus. Dimensions: 24.12"H x 1.75"W x 7"D (613mm x 44.5mm x 178mm).	1
PV12PN*	Vertical power strip 30 Amp, 240V, (12) IEC, C-13 receptacles, (2) 15 Amp magnetic breakers, 10' power cord with IEC 309 plug, CE TUV T-Mark for EN60950-1. Dimensions: 24.12"H x 1.75"W x 7"D (613mm x 44.5mm x 178mm).	1
PC14C13-KIT	1.5' (458mm) Black C13 to C14 Power Cord (P/N: PC14C13BL1.5), 2.0' (610mm) Black C13 to C14 Power Cord (P/N: PC14C13BL2), Plug Retainer, Black (P/N: PC14C13-60), Plug Retainer, Natural Ivory (P/N: PC14C13-69).	1

*For use with Net-Access™ Cabinet.

Net-Access™ Cable Routing Systems

CabRunner™ Overhead Cable Routing System

The CabRunner™ Overhead Cable Routing System protects, routes, and manages large quantities of twisted pair data cables into and out of Net-Access™ Cabinets. This versatile system quickly mounts to the top of the cabinets and easily integrates with other cable pathways used throughout the data center for reduced installation costs.

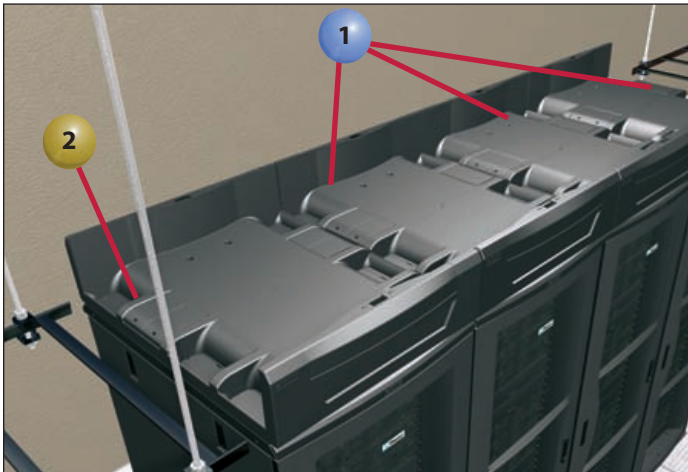

CabRunner™ Overhead Cable Routing System mounts directly on top of Net-Access™ Switch and Server Cabinets for ease of installation.

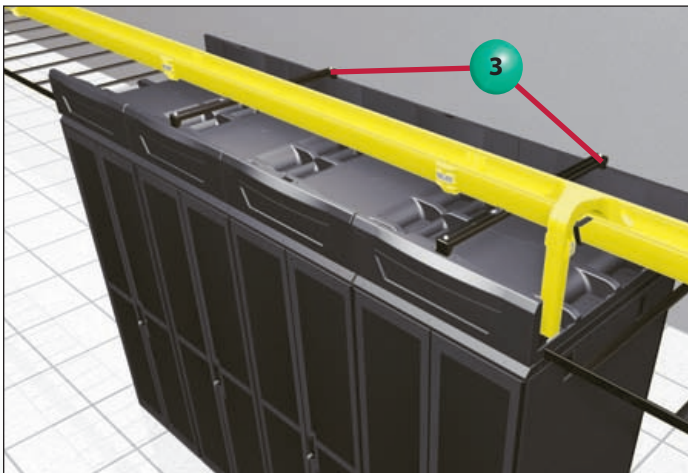

FiberRunner® Cable Routing System mounts to CabRunner™ Overhead Cable Routing System with optional trapeze bracket providing greater versatility.

1 Innovative Design

- Eliminates need for multiple infrastructure elements reducing installation time
- Complements cabinet design enhancing data center aesthetics
- Large pathway area accommodates high cable densities



2 Cable Routing and Management

- Multiple spillouts align with inlets on cabinets providing greater routing versatility
- Injection molded bridges cover unused spillouts to protect cables improving network performance



3 Integration with Fiber Optic Pathway

- Trapeze brackets allow fast and easy integration of the FiberRunner® Cable Routing System, reducing installation time and offering greater system flexibility



FiberRunner® Cable Routing System

The FiberRunner® Routing System consists of channels, fittings, and spillouts designed to segregate, route, and protect fiber optic and high performance copper cabling. Supported by a trapeze bracket, it can be installed directly over the CabRunner™ Overhead Cable Routing System for enhanced system flexibility.

Net-Access™ Cabinet Specifications

- 84.0"H x 31.5"W x 41.1"D (2134mm x 800mm x 1044mm) – 45 RU
- All welded frame construction
- Adjustable equipment mounting rails
- CN series equipment mounting depth up to 25.9" (658mm)
- CS series equipment mounting depth up to 29" (737mm), rear rail adjustment only
- Doors include keyed swing handles
- Side panels include keyed push button latches

- Cabinet supplied with cable management; for additional cable management finger sections, specify part number CNBRFK
- Durable black polyester epoxy powder coat finish
- UL Listed 2500 lbs. (1134 kg) load rating
- Cabinet ships assembled, one per pallet
- CN cabinets include hardware kit: (25) #12-24 screws, ganging brackets, and grommet edging
- CS cabinets include hardware kit: (50) cage-nuts and screws, ganging brackets, anti-tip brackets, and grommet edging

Cable Capacity

Channel	No Slack Spool							With Slack Spool						
	Channel Area		Cable Capacity*					Channel Area		Cable Capacity*				
	In. ²	cm ²	Cat 6A (0.298")	Cat 6A (0.289")	Cat 6 (0.250")	Cat 5e (0.187")	Fiber (3mm)	In. ²	cm ²	Cat 6A (0.298")	Cat 6A (0.289")	Cat 6 (0.250")	Cat 5e (0.187")	Fiber (3mm)
End	42.2	272.3	242	257	343	614	1540	32.4	209	185	197	264	471	1182
Center	84.4	544.5	484	514	687	1229	3081	74.6	481.3	427	454	607	1086	2723

*Note: Capacities are based upon a fill rate of 40% to accommodate proper cable routing techniques.

Net-Access™ Switch Cabinet



CN1
CN1CN



CN2
CN2CN



CN3
CN3CN



CN4



CN5

Part Number	Description	Std. Pkg. Qty.
CN1**	Cabinet with dual hinge perforated front door. Split perforated rear door. Solid side panels. Two sets of #12-24 threaded equipment mounting rails. 45 RU cable management on front and rear of front posts. Empty cabinet weight is 373 lbs. (169 kg).	1
CN2**	Cabinet with dual hinge perforated front door. Split perforated rear door. Two sets of #12-24 threaded equipment mounting rails. 45 RU cable management on front and rear of front posts. Empty cabinet weight is 275 lbs. (125 kg).	1
CN3**	Cabinet with two sets of #12-24 threaded equipment mounting rails. 45 RU cable management on front and rear of front posts. Empty cabinet weight is 207 lbs. (94 kg).	1
CN4	Cabinet with split perforated front and rear doors. Solid side panels. Two sets of #12-24 threaded equipment mounting rails. 45 RU cable management on front and rear of front posts. Empty cabinet weight is 360 lbs. (163 kg).	1
CN5	Cabinet frame with split perforated front and rear doors. Two sets of #12-24 threaded equipment mounting rails. 45 RU cable management on front and rear of front posts. Empty cabinet weight is 262 lbs. (119 kg).	1

**For cage nut rails, use CN*CN, i.e. CN1CN.

Net-Access™ Server Cabinet



CS1



CS2



CS3

Part Number	Description	Std. Pkg. Qty.
CS1	Cabinet with single hinge perforated front door. Split perforated rear door. Solid side panels. Two sets of cage nut equipment mounting rails. 45 RU cable management on rear of rear posts. One set of vertical blanking panels. One set of POU mounting brackets. Empty cabinet weight is 397 lbs. (180 kg).	1
CS2	Cabinet with single hinge perforated front door. Split perforated rear door. Two sets of cage nut equipment mounting rails. 45 RU cable management on rear of rear posts. One set of vertical blanking panels. One set of POU mounting brackets. Empty cabinet weight is 297 lbs. (135 kg).	1
CS3	Cabinet with two sets of cage nut equipment mounting rails. 45 RU cable management on rear of rear posts. One set of vertical blanking panels. One set of POU mounting brackets. Empty cabinet weight is 226 lbs. (102 kg).	1

Net-Access™ Vertical Exhaust System

- For use with Panduit® Net-Access™ Server Cabinet (CS Series)
- Engineered design minimizes required plenum area behind cabinet
- Cabinet extension adds 6.5 inches (165mm) to depth of cabinet
- Passive cooling system
- Directly vents network equipment exhaust into return plenum of data center



Part Number	Description	Std. Pkg. Qty.
CVED32	Vertical exhaust cabinet extension and solid rear split doors. Leveling legs and gasket kit included.	1
CVED32VE	Variable duct extension is infinitely adjustable between 42" (1067mm) to 70" (1778mm).	1
CVED32VES	Variable short duct extension is infinitely adjustable between 20.0" (508mm) to 36.0" (914mm).	1

Net-Access™ Cabinet Accessories



CNDDDE



CNDSH



CNDS



CNPS



CNRT



CSRCE

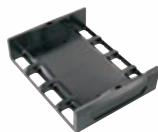

CRB6BL



CRB6VEDBL



CRBRDGBL



CRTB



CRVEDTB

Part Number	Description	Std. Pkg. Qty.
CNDDDE	Dual hinge door opens to the left and right to provide maximum accessibility to the cabinet. Open perforated design enables optimum airflow to equipment. Includes keyed swing handles and two point latches.	1
CNDSH	Single hinge door quickly reverses from left-hinging to right-hinging for increased data center design flexibility. Open perforated design enables optimum airflow to equipment. Includes keyed swing handles.	1
CNDS	Split doors open in the middle, minimize the door swing footprint and can be used in narrow data center hot aisles. Perforated design provides optimum airflow. Includes keyed swing handles and single point latch.	1
CNPS	Removable solid side panel covers and protects cable and equipment. Lockable push button latches allow for quick release and removal of side panels for easier and faster moves, adds, and changes.	1
CNPP	Removable perforated side panels cover and protect cable and equipment. Lockable push button latches allow for quick release and removal of side panels for easier and faster moves, adds, and changes.	1
CNRT	#12-24 threaded equipment mounting rails, sold in pairs. For use when additional sets of rails are desired for multiple equipment mounting depths within a cabinet.	1
CNRC	Cage nut equipment mounting rails, sold in pairs.	1
CSRCE	Extended front server cabinet cage nut equipment mounting rails, sold in pairs.	1
CRB6BL	CabRunner™ Overhead Cable Routing System Base Unit with 6" (150mm) high wall. Supplied with shroud and fasteners required for assembly to Net-Access™ Cabinets.	1
CRB6VEDBL	CabRunner® Overhead Cable Routing System Base Unit with 6" (150mm) high wall. Supplied with a shroud and fasteners required for assembly to Net-Access™ Cabinets with a Vertical Exhaust Duct.	1
CRBRDGBL	CabRunner™ Overhead Cable Routing System Bridge Insert. Snaps in to CRB6BL to cover unused cable spillouts and provide bend radius control for adjacent cabinet.	1
CRTB	CabRunner™ Overhead Cable Routing System Trapeze Bracket. Used to provide a mounting structure for integrating FiberRunner® Cable Routing System to the base unit.	1
CRVEDTB	CabRunner® Overhead Cable Routing System Trapeze Bracket. Used to provide a mounting structure for integrating FiberRunner® Cable Routing System to the base unit on Net-Access™ Cabinets with a vertical exhaust duct.	1

Part Number	Description	Std. Pkg. Qty.
CNBRFK	9 RU cable management finger sections. Kit includes finger sections to complete two sides of posts.	1
CNAE1	Air ducts provide exhaust channels for equipment for high heat density configurations. Designed for Cisco^ 6509 switch.	1
CNAE2	Air ducts provide exhaust channels for equipment for high heat density configurations. Designed for Cisco^ 9513 switch.	1
CNAE3	Air ducts provide exhaust channels for equipment for high heat density configurations. Designed for Cisco^ 6513 switch.	1
CNAE7018	Air duct kit for Cisco^ Nexus 7018 switch. Use with CN7018-EXT extension kit and CN3 cabinet to house the Cisco^ Nexus 7018 switch.	1
CNPS7018	Removable solid side panels cover and protect cable and equipment. Side panels for use with CN7018-EXT extension kit for the cabinet to house the Cisco^ Nexus 7018 switch. Covers one side of cabinet (2 required per cabinet).	1
CN7018-EXT	Cabinet extension kit for Cisco Nexus 7018 switch. Use CN3 cabinet to achieve 40"W x 48"D (1003mm x 1219mm) cabinet frame.	1
CNSPE	End channel slack spools manage copper and fiber patch cord slack in the vertical pathway. Package includes left and right slack spools and mounting brackets.	1
CNSPCA	Center channel slack spool for use between ganged cabinets. Includes one center spool and one mounting bracket.	1
CNFBB	Side cabinet cable management bracket for side mounting 19" EIA equipment.	1
CNCSTR	Casters can be field installed without tipping cabinet for easy movement of a loaded or unloaded cabinet. Includes set of four casters.	1
CVPPB	Bracket to vertically mount 1 RU EIA 19" products including copper and fiber patch panels and power outlet units.	1
CVPDUB	Bracket for vertical POU mounting to the side of the cabinet posts (kit of two).	1



CNBRFK



CNAE1



CNSPE



CNSPCA



CNFBB



CNCSTR



CVPPB



CVPDUB

^Cisco is a registered trademark of Cisco Technology, Inc.

Net-SERV™ Cabinet

700mm (28") Wide – Vertical Patch Panel Server Configuration

Vertical patch panels maximize rack space utilization for additional servers and other devices.

- Cabinets provide an optimized solution for server applications, and complement the Net-Access™ Cabinet with a consistent aesthetic appearance

* Vertical patch panel solution provides up to four additional rack units in the same footprint

* Positions network connections in the optimum location allowing the use of single length patch cords

* See page 24 for detailed ordering information

1 Finger Cable Management

- Fingers align with rack spaces to ensure proper bend radius control and support cables as they transition to the vertical pathway
- Finger sections can be located where needed to manage cables for greater routing flexibility



2 Thermal Management

- Cable management, outset cabinet frame, perforation patterns and vertical blanking panels work together to ensure proper server airflow



3 Power Outlet Unit Mounting

- Brackets are included to vertically mount POU's minimizing power cord lengths
- Tool-less mounting of Panduit or other POU's



4 Vertical Patch Panel Mounting

- Brackets allow for vertical mounting of up to four 1 RU EIA 19" copper or fiber patch panels to the side of the cabinet posts
- Aligns ports with rack spaces allowing standardization of patch cord lengths to reduce cable slack and provide superior thermal management



Net-SERV™ Cabinet

700mm (28") Wide – High Density Server Configuration

Data and power cables are organized in segregated channels away from server exhaust for unobstructed air flow.

- 700mm (28") wide Net-SERV™ Cabinets provide an optimized solution for server applications, and complement the Net-Access™ Cabinet with consistent aesthetic appearance
- The high density solution provides four separate vertical pathways and modular L-rings with bend radius control for optimum cable routing
- See page 25 for detailed ordering information



1 Vertical Exhaust Duct

- Optional duct directs hot exhaust air to the plenum, enabling improved cooling efficiency



2 Thermal Management

- Cable management, outset cabinet frame, perforation patterns, and vertical blanking panels work together to ensure proper server airflow

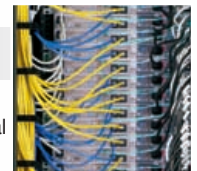

3 Power Outlet Unit Mounting

- Brackets are included to vertically mount POUs, minimizing power cord lengths
- Tool-less mounting of Panduit or other POUs



4 Cable Management Channel

- Four channels per cabinet provide optimal cable management channels for segregation
- Modular L-rings provided per channel allow placement of cable management at desired rack unit
- Channel capacity = 203 (Cat. 6A cables @0.310 dia. @ 40% Fill)



Net-SERV™ Cabinet

600mm (24") Wide – Standard Density Server Configuration

Integral cable management and POU mounting brackets accommodate a wide range of server applications.

- 600mm (24") wide Net-SERV™ Cabinets utilize the minimum footprint required for server applications and complement the Net-Access™ Cabinet with a consistent aesthetic appearance
- The standard density solution provides cable management fingers at each rack unit to manage data and power cables
- See page 23 for detailed ordering information

1 Thermal Management

- Cable management, outset cabinet frame, perforation patterns, and vertical blanking panels work together to ensure proper server airflow



2 Power Outlet Unit Mounting

- Brackets are included to vertically mount POUs, minimizing power cord lengths
- Tool-less mounting of Panduit or other POUs



3 Finger Cable Management

- Fingers align with rack spaces to ensure proper bend radius control and support cables as they transition to the vertical pathway
- Finger sections can be located where needed to manage cables for greater routing flexibility
- Channel capacity = 94 (Cat. 6A cables @0.310 dia. @ 40% Fill)

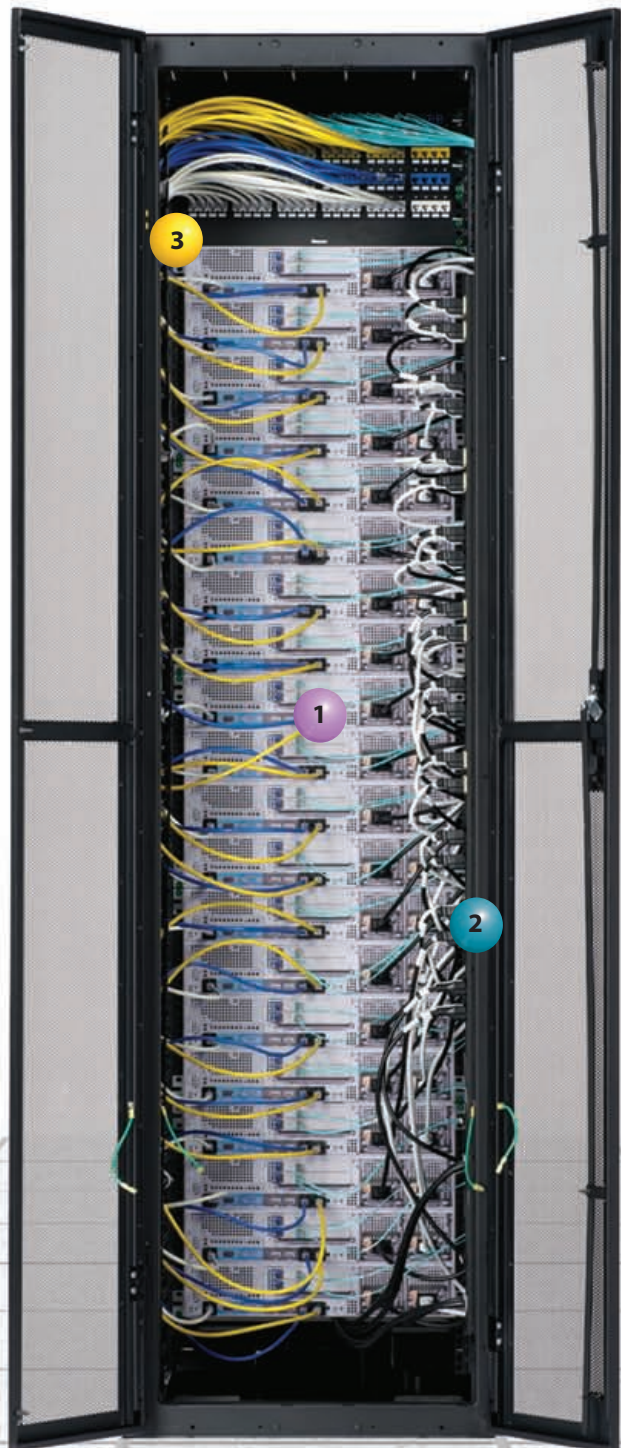

Net-SERV™ Cabinet

600mm (24") Wide – High Density Server Configuration

Data and power cables are organized in segregated channels away from server exhaust for unobstructed air flow.

- 600mm (24") wide Net-SERV™ Cabinets utilize the minimum footprint required for server applications and complement the Net-Access™ Cabinet with a consistent aesthetic appearance
- The high density solution provides four separate vertical pathways and modular L-rings with bend radius control for segregated cable routing
- See page 25 for detailed ordering information



1 Vertical Exhaust Duct

- Optional duct directs hot exhaust air to the plenum, enabling improved cooling efficiency



2 Thermal Management

- Cable management, outset cabinet frame, perforation patterns, and vertical blanking panels work together to ensure proper server airflow

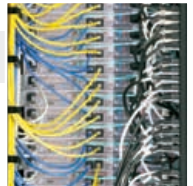

3 Power Outlet Unit Mounting

- Brackets are included to vertically mount POUs, minimizing power cord lengths
- Tool-less mounting of Panduit or other POUs



4 Cable Management Channel

- Four channels per cabinet provide optimal cable management channels for segregation
- Modular L-rings provided per channel allow placement of cable management at desired rack unit
- Channel capacity = 122 (Cat. 6A cables @ 0.310 dia. @ 40% Fill)



Net-SERV™ Cabinet Specifications

- 1200mm (48") depth
- Two sets, cage nut, infinitely adjustable equipment mounting rails, (50) #12-24 cage nuts and screws included
- Printed rack space identification on front and back of rails, default is numbers up, may be field adjusted to numbers down
- Equipment mounting depth up to 42" (1067mm)
- Doors include keyed swing handles
- Side panels include keyed locks
- POU mounting brackets included to mount two POU's
- Vertical blanking panels installed
- Easily adjustable leveling legs installed
- Ganging brackets included
- Anti-tip brackets included
- Available in four configuration options: Basic, Standard Density, High Density, and Vertical Patching
- Durable black polyester epoxy powder coat finish
- All welded frame construction
- 2500 lbs. (1134 kg) load rating
- Removable top cap included
- Cabinet ships assembled, one per pallet
- Optional casters available
- Optional vertical exhaust duct for maximum energy efficiency



Part Number Example:

S	7	5	2	C	1	2	9	H	V
Series	Width	Height	Depth	Rails	Front Doors	Back Doors	Side Panel	Cable Management	Top Panel
S = Server	6 = 600mm (23.6") 7 = 700mm (27.6")	2 = 42RU 5 = 45RU	2 = 1200mm (47.2")	C = Cage Nuts, Numbers Up	1 = Perf. Full Single Hinge	2 = Perforated Split 3 = Solid Full Single Hinge	1 = One Single Side Panel 2 = Two Side Panels 9 = No Side Panels	F = Standard Density – Left and Right Fingers H = High Density – Four Cable Management Panels P = Vertical Patch B = Basic – No Cable Mgmt.	V = Vertical Exhaust Duct

Basic Configuration

- Cabinet provided without cable management
- Includes brackets for mounting two vertical power outlet units



Part Number	Width	Height	Description
S722C122B	28"/700mm	42 RU (78"/1984mm)	Cabinet with full perforated front door. Split perforated rear door. Solid side panels.
S752C122B	28"/700mm	45 RU (83"/2118mm)	
S622C122B	24"/600mm	42 RU (78"/1984mm)	
S652C122B	24"/600mm	45 RU (83"/2118mm)	



Part Number	Width	Height	Description
S722C129B	28"/700mm	42 RU (78"/1984mm)	Cabinet with full perforated front door. Split perforated rear door. No side panels.
S752C129B	28"/700mm	45 RU (83"/2118mm)	
S622C129B	24"/600mm	42 RU (78"/1984mm)	
S652C129B	24"/600mm	45 RU (83"/2118mm)	

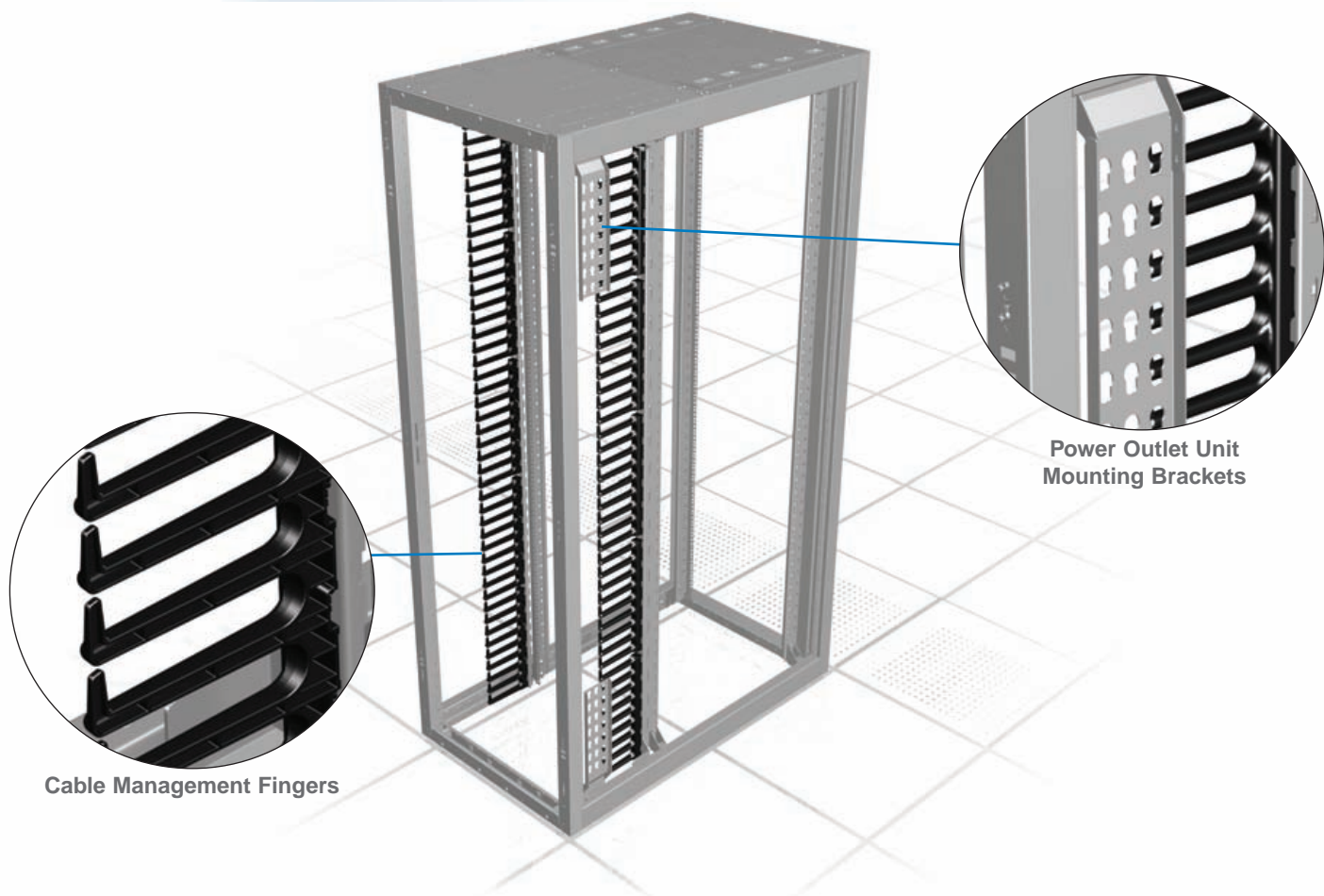

Cable Management Fingers

Power Outlet Unit Mounting Brackets

Standard Density Cable Management Configuration

- Cabinet supplied with two sets of cable management fingers

Part Number	Width	Height	Description
S722C122F	28"/700mm	42 RU (78"/1984mm)	Cabinet with full perforated front door. Split perforated rear door. Solid side panels.
S752C122F	28"/700mm	45 RU (83"/2118mm)	
S622C122F	24"/600mm	42 RU (78"/1984mm)	
S652C122F	24"/600mm	45 RU (83"/2118mm)	

Part Number	Width	Height	Description
S722C129F	28"/700mm	42 RU (78"/1984mm)	Cabinet with full perforated front door. Split perforated rear door. No side panels.
S752C129F	28"/700mm	45 RU (83"/2118mm)	
S622C129F	24"/600mm	42 RU (78"/1984mm)	
S652C129F	24"/600mm	45 RU (83"/2118mm)	



Net-SERV™ Cabinet Specifications

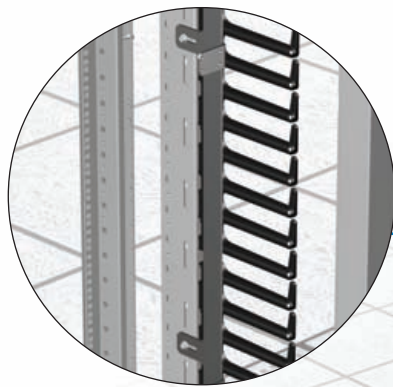

Vertical Patch Panel Mounting Brackets

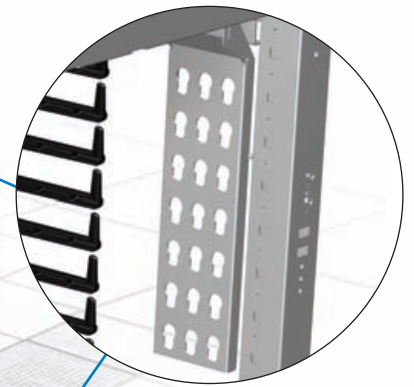

Power Outlet Unit Mounting Brackets

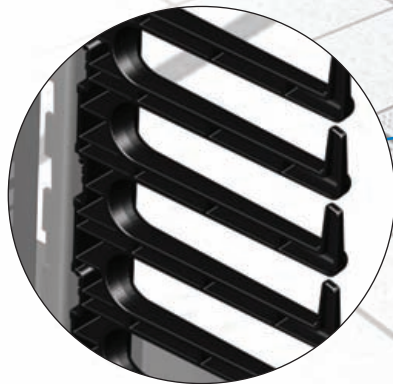

Cable Management Fingers

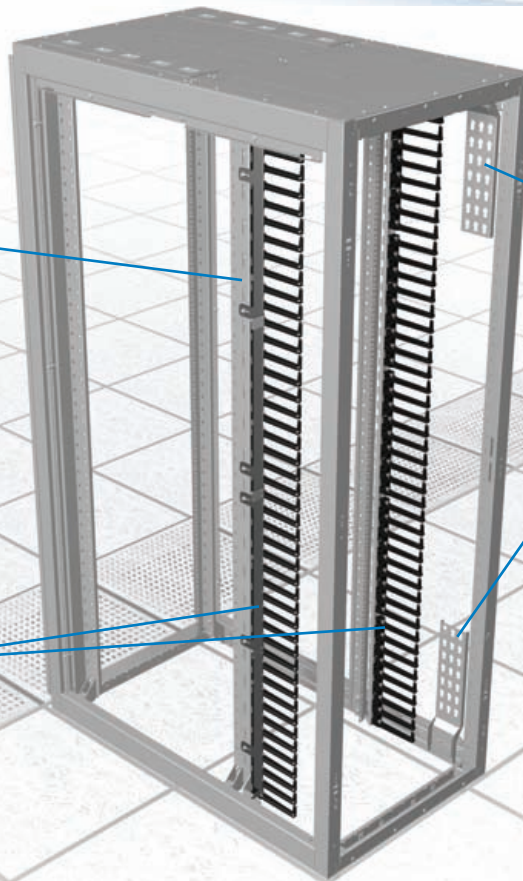

Vertical Patch Cable Management Configuration

- Cabinet supplied with cable management fingers and vertical 19" EIA brackets

Part Number	Width	Height	Description
S722C122P	28"/700mm	42 RU (78"/1984mm)	Cabinet with full perforated front door.
S752C122P	28"/700mm	45 RU (83"/2118mm)	Split perforated rear door. Solid side panels.



Part Number	Width	Height	Description
S722C129P	28"/700mm	42 RU (78"/1984mm)	Cabinet with full perforated front door.
S752C129P	28"/700mm	45 RU (83"/2118mm)	Split perforated rear door. No side panels.

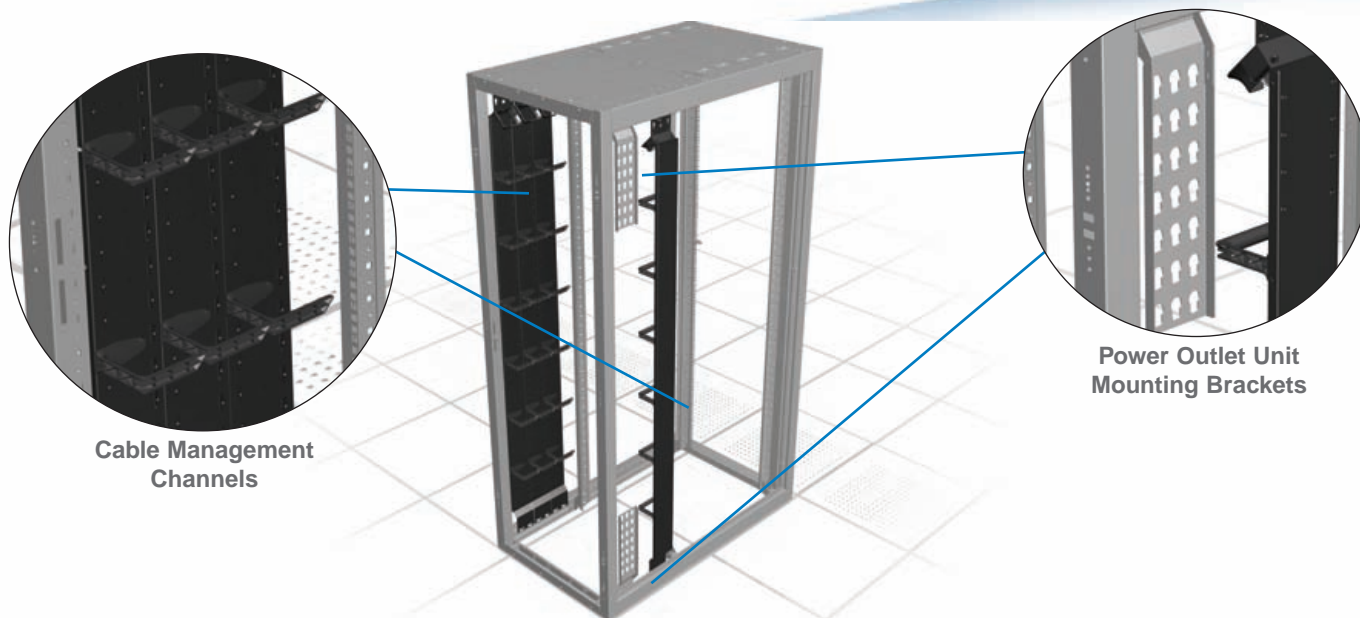

Cable Management Channels

Power Outlet Unit Mounting Brackets

High Density Cable Management Configuration

- Cabinet supplied with four cable management channels and L-Rings

Part Number	Width	Height	Description
S722C122H	28"/700mm	42 RU (78"/1984mm)	Cabinet with full perforated front door. Split perforated rear door. Solid side panels.
S752C122H	28"/700mm	45 RU (83"/2118mm)	
S622C122H	24"/600mm	42 RU (78"/1984mm)	
S652C122H	24"/600mm	45 RU (83"/2118mm)	



Part Number	Width	Height	Description
S722C129H	28"/700mm	42 RU (78"/1984mm)	Cabinet with full perforated front door. Split perforated rear door. No side panels.
S752C129H	28"/700mm	45 RU (83"/2118mm)	
S622C129H	24"/600mm	42 RU (78"/1984mm)	
S652C129H	24"/600mm	45 RU (83"/2118mm)	

Configuration for Vertical Exhaust Duct and High Density Cable Management

- Cabinet supplied with four cable management channels and L-Rings
- Vertical exhaust duct extends cabinet supplied with 42"(1067mm) to 70"(1778mm)
- Directly vents network equipment exhaust into return plenum of data center

Part Number	Width	Height	Description
S722C131HV	28"/700mm	42 RU (78"/1984mm)	Cabinet with full perforated front door. Solid rear door. Single side panel.
S752C131HV	28"/700mm	45 RU (83"/2118mm)	
S622C131HV	24"/600mm	42 RU (78"/1984mm)	
S652C131HV	24"/600mm	45 RU (83"/2118mm)	





S22PS
S52PS

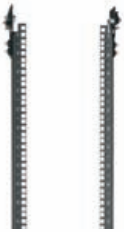

S62RC
S72RC
S65RC
S75RC



SCSTR



SVPDUB



SVPPB

Part Number	Description	Std. Pkg. Qty.
Side Panels		
S22PS	42 RU removable solid side panel covers and protects cable and equipment. Single Lock allows for quick release and removal of side panels for easier and faster moves, adds, and changes.	1
S52PS	45 RU removable solid side panel covers and protects cable and equipment. Single Lock allows for quick release and removal of side panels for easier and faster moves, adds, and changes.	1
Equipment Mounting Rails		
S62RC	42 RU x 600mm (24") wide cage nut equipment mounting rails, sold in pairs.	1
S72RC	42 RU x 700mm (28") wide cage nut equipment mounting rails, sold in pairs.	1
S65RC	45 RU x 600mm (24") wide cage nut equipment mounting rails, sold in pairs.	1
S75RC	45 RU x 700mm (28") wide cage nut equipment mounting rails, sold in pairs.	1
Casters		
SCSTR	Includes set of four casters.	1
Power Outlet Unit Mounting Brackets		
SVPDUB	Brackets for tool-less mounting of two power outlet units.	1
Vertical Patch Panel Mounting Bracket		
SVPPB	Bracket to vertically mount 1 RU EIA 19" products including copper and fiber patch panels.	1

Top of Cabinet Air Sealing Accessories

Designed for the Net-Access™ and Net-SERV™ Cabinets, innovative air sealing accessories prevent cooling air from escaping through cable inlets improving thermal efficiency of the cabinets. Air sealing accessories snap into the cabinet top knock-outs for fast configuration.



Cool Boot® Cabinet Top Air Sealing Fitting is used to seal copper data cables entering the cabinet.

600 mm (24") Net-SERV™ Cabinet shown with optional vertical exhaust duct.

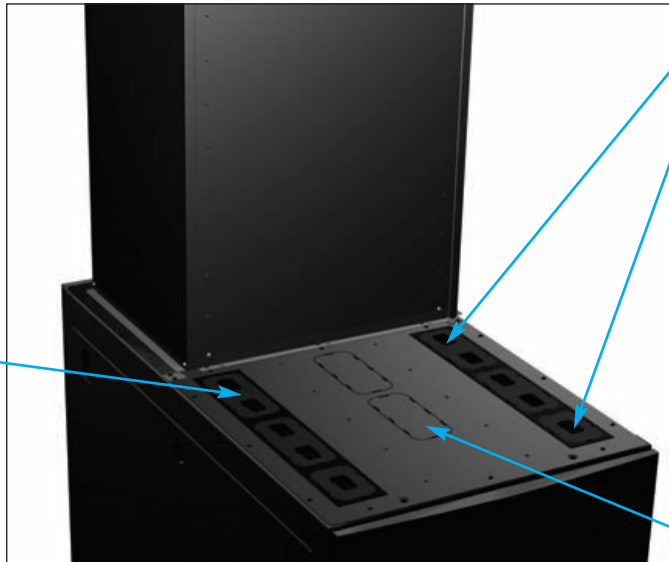

Net-SERV™ Cabinets are provided with four pre-installed 3"x 8" and two 3"x 5" cabinet top covers and cable protection bezels.



Cabinet Top Air Sealing Fiber Optic Fitting is used to provide a transition and seal for fiber optic cables entering the cabinet via slit corrugated tubing.



Cabinet Top Cover and Cable Protection Bezel are used when additional knock-outs are removed from the cabinet.

Part Number	Description	Std. Pkg. Qty.
Cool Boot® Cabinet Top Air Sealing Fitting		
CTG3X8	Used to seal off 3" x 8" cabinet top openings when cables are routed through the top of a cabinet. Airtight fabric and Ultra-Cinch™ Tie closes top of fabric, minimizing hot air bypass around cables to improve cooling of network equipment and reduce energy costs. For use with both Net-SERV™ and Net-Access™ Cabinets.	1
Cabinet Top Air Sealing Fiber Optic Fitting		
CTIDT15	Used to transition 1.5" (38mm) diameter slit corrugated tubing directly into a 3" x 8" or 3" x 5" cabinet top opening. Split design allows easy access to add or remove cables. Fitting minimizes hot air bypass around tubing to improve cooling of network equipment and reduce energy costs. For use with both Net-SERV™ and Net-Access™ Cabinets.	1
Cabinet Top Cover and Cable Protection Bezel		
CTCC3X8	Used to seal off 3" x 8" cabinet top openings after knock-outs are removed. Can also be used to add the CTG3X8 or CTIDT15 to openings where knock-out has been removed. For use with both Net-SERV™ and Net-Access™ Cabinets.	1
Slit Corrugated Loom Tubing		
CLT150F-X3*	Slit corrugated loom tubing provides a vertical pathway as cables transfer from the FiberRunner® Fitting to the equipment below. Inside diameter is 1.5" (38.1mm) and outside diameter 1.7" (43.2mm). Sold in 10' rolls.	1



*For other colors replace suffix X3 (Orange) with X4 (Yellow) or X20 (Black).

Power Outlet Units



CMRPSH15

Part Number	Description	Std. Pkg. Qty.
Horizontal 15 AMP		
CMRPSH15	Horizontal power strip with a 15 A, 125 V, ten NEMA 5-15R receptacles, one 15 A thermal breaker, and 10' power cord with NEMA 5-15P plug. UL and c-UL Listed. Dimensions: 1.7"H x 19"W x 3.8"D (44mm x 483mm x 95mm).	1



CMRPSH20

Horizontal 20 AMP With and Without Digital Monitor		
CMRPSH20	Horizontal power strip with a 20 A, 125 V, ten NEMA 5-20R receptacles, one 20 A thermal breaker, and 10' power cord with NEMA 5-20P plug. UL and c-UL Listed. Dimensions: 1.7"H x 19"W x 3.8"D (44mm x 483mm x 95mm).	1
CMRPSH20M	Horizontal power strip with a 20 A, 125 V, ten NEMA 5-20R receptacles, one 20 A thermal breaker, red LED current monitor and 10' power cord with NEMA 5-20P plug. UL and c-UL Listed. Dimensions: 1.7"H x 19"W x 4.5"D (44mm x 483mm x 1148mm).	1



CMRPSV20

Vertical 20 AMP With Straight and Twist Lock Plug		
CMRPSV20	Vertical power strip with a 20 A, 125 V, ten NEMA 5-20R receptacles, one 20 A thermal breaker, and 10' power cord with NEMA 5-20P plug. UL and c-UL Listed. Dimensions: 38.5"H x 1.9"W x 1.3"D (978mm x 47mm x 33mm).	1
CMRPSV20TL	Vertical power strip with a 20 A, 125 V, ten NEMA 5-20R receptacles, one 20 A thermal breaker, and 10' power cord with NEMA L5-20P twist lock plug. UL and c-UL Listed. Dimensions: 38.5"H x 1.9"W x 1.3"D (978mm x 47mm x 33mm)	1
CMRPSVD20	Vertical power strip with dual 20 A, 125 V ten NEMA 5-20R receptacles per circuit, two 20 A thermal breakers, and two 15' power cords with NEMA 5-20P plugs. UL and c-UL Listed. Dimensions: 66.3"H x 1.9"W x 1.3"D (1683mm x 47mm x 33mm).	1
CMRPSVD20TL	Vertical power strip with dual 20 A, 125 V ten NEMA 5-20R receptacles per circuit, two 20 A thermal breakers, and two 15' power cords with NEMA L5-20P twist lock plugs. UL and c-UL Listed. Dimensions: 66.3"H x 1.9"W x 1.3"D (1683mm x 47mm x 33mm).	1



CMRPSVD20

Refer to www.panduit.com for detailed information on the complete line of power outlet units.

Power Outlet Units (continued)

Part Number	Description	Std. Pkg. Qty.
Horizontal 30 AMP With and Without Digital Monitor		
RPSH103C13TL6M	19" horizontal or vertical power strip 30 A, 250 V, ten IEC-13 receptacles, four 15 A thermal breakers, red LED current monitor, and 10' power cord with NEMA L6-30P twist lock plug. Mounts horizontal or vertical. UL and c-UL Listed. Dimensions: 1.7"H x 19.0"W x 1.6"D (43mm x 483mm x 41mm).	1
RPSH163C13TL6	Horizontal power strip 30 A, 250 V, sixteen IEC-13 receptacles, four 15 A thermal breakers, and 10' power cord with NEMA L6-30P twist lock plug. UL and c-UL Listed. Dimensions: 3.5"H x 19"W x 1.6"D (88mm x 483mm x 41mm).	1
RPSH163C13TL6M	Horizontal power strip 30 A, 250 V, sixteen IEC-13 receptacles, four 15 A thermal breakers, red LED current monitor, and 10' power cord with NEMA L6-30P twist lock plug. UL and c-UL Listed. Dimensions: 3.5"H x 19"W x 1.6"D (88mm x 483mm x 41mm).	1
Vertical 30 AMP		
RPSV243520TL5	Vertical power strip 30 A, 125 V, 24 NEMA 5-20R receptacles, two 20 A single pole magnetic breaker/switch with integral switch guard, 10' power cord with NEMA L5-30P twist lock plug. UL and c-UL Listed. Dimensions: 66.3"H x 2.0"W x 2.0"D (1683mm x 51mm x 51mm).	1
RPSV243620TL6	Vertical power strip 30 A, 250 V, 24 NEMA 6-20R receptacles, two 20 A double pole magnetic breaker/switch with integral switch guard, 10' power cord with NEMA L6-30P twist lock plug. UL and c-UL Listed. Dimensions: 66.3"H x 2.0"W x 2.0"D (1683mm x 51mm x 51mm).	1
RPSV303C139TL6	Vertical power strip 30 A, 250 V, 24 IEC-13 and 6 IEC-19 receptacles, two 20 A double pole magnetic breaker/switch with integral switch guard, 10' power cord with NEMA L6-30P twist lock plug. UL and c-UL Listed. Dimensions: 66.3"H x 2.0"W x 2.0"D (1683mm x 51mm x 51mm).	1
RPSV303C139TL6M	Vertical power strip 30 A, 250 V, 24 IEC-13 and 6 IEC-19 receptacles, two 20 A double pole magnetic breaker/switch with integral switch guard, red LED current monitor and 10' power cord with NEMA L6-30P twist lock plug. UL and c-UL Listed. Dimensions: 66.3"H x 2.0"W x 2.0"D (1683mm x 51mm x 51mm).	1
PC14C13BL1.5	1.5' (458mm) black C13 to C14 power cord.	1
PC14C13BL2	2.0' (610mm) black C13 to C14 power cord.	1
PC14C13BL3	3.0' (915mm) black C13 to C14 power cord.	1



RPSH103C13TL6M



RPSH163C13TL6



RPSV243620TL6



Refer to www.panduit.com for detailed information on the complete line of power outlet units.



DPFP1



DPFP2



DPFP4



DPFP8



RSHLF23



RFG12X4SMY



CDE1

Part Number	Description	Std. Pkg. Qty.
DPFP1	1 RU metal horizontal blanking panel to prevent cold air bypass through open rack units.	1
DPFP2	2 RU metal horizontal blanking panel to prevent cold air bypass through open rack units.	1
DPFP4	4 RU metal horizontal blanking panel to prevent cold air bypass through open rack units.	1
DPFP8	8 RU metal horizontal blanking panel to prevent cold air bypass through open rack units.	1
RSHLF23	Adjustable shelf, 275 lbs. load rating. Dimensions: 1.7"H x 19.0"W x 23.0"D.	1
RSHLF	Adjustable shelf, 275 lbs. load rating. Dimensions: 1.7"H x 19.0"W x 30.0"D.	1
RFG12X4SMY	Cool Boot™ Raised Floor Air Sealing Grommet for surface mount applications. Overall size of 12" x 4" allows for 10.2" x 2.2" capacity.	1
RFG12X8SMY	Cool Boot™ Raised Floor Air Sealing Grommet for surface mount applications. Overall size of 12" x 8" allows for 10.2" x 6.2" capacity.	1
RFG12X4Y	Cool Boot™ Raised Floor Air Sealing Grommet for integral mount applications. Overall size of 12" x 4" allows for 10.2" x 2.2" capacity.	1
RFG12X8Y	Cool Boot™ Raised Floor Air Sealing Grommet for integral mount applications. Overall size of 12" x 8" allows for 10.2" x 6.2" capacity.	1
CDE1	Server cabinet to air intake duct for high heat density configurations. Designed for Cisco^ 4948, 4928, and 4924 switch.	1

^Cisco is a registered trademark of Cisco Technology, Inc.

Part Number	Description	Std. Pkg. Qty.
CGNBSK	Bonding stud kit for cage nut rail fasteners; includes 25 bonding studs and 50 bonding nuts.	1
RGCBNJ660P22	Common bonding network (CBN) jumper kit; #6 AWG (16mm ²); 60" (1.52m) length; 45° bent lug on grounding strip side; provided with .16 oz. (5cc) of antioxidant, two each #12-24 x 1/2", M6 x 12mm, #10-32 x 1/2" and M5 x 12mm thread-forming screws and a copper compression HTAP for connecting to the MCBN in sizes ranging from #6-#2 AWG (16 – 25mm ²).	1
RGS134-1Y	Rack grounding strip kit; 78.65" (2m) length; .67" (17mm) width; .05" (1.27mm) thickness; provided with .16 oz. (5cc) of antioxidant, one grounding sticker and three each #12-24 x 1/2", M6 x 12mm, #10-32 x 1/2" and M5 x 12mm thread-forming screws.	1
RGS134B-1	Cage nut grounding strip kit; 78.65" (2m) length; .67" (17mm) width; .05" (1.27mm) thickness; provided with .16 oz. (5cc) of antioxidant, one grounding sticker, three cage nut bonding studs, eight #12-24 bonding nuts and three strip clips.	1
RGESD2B-1	ESD port kit for cage nut rail fasteners: two-hole ESD port with 5/8" hole spacing, provided with an ESD protection sticker, .16 oz. (5cc) of antioxidant, two cage nut bonding studs and two #12-24 bonding nuts.	1
RGESDWS	Adjustable fabric ESD wrist strap with 6' coil cord, banana plug, 1 megohm resistor and 4mm snap.	1

Refer to www.panduit.com/dcgrounding for detailed information on the complete line of StructuredGround™ Grounding System products.



CGNBSK



RGCBNJ660P22



RGS134-1Y



RGS134B-1



RGESDWS

Real-World Solutions to Ensure the Success of Our Customers

With a proven reputation for excellence and technology innovation, a robust ecosystem of global partners, and long-term alliances with top industry leaders, Panduit is a valuable, trusted partner offering strategic vision and real-world solutions to ensure the success of our customers.



Innovative Technology Leadership

Panduit is an industry leader in developing innovative technology solutions that meet the rapidly evolving needs of our customers around the world. Our commitment to continued leadership is supported by significant ongoing investment, dedicated manufacturing facilities, strategic technology alliances, and collaborative R&D with other industry leaders.



Global Business & Commitment

Panduit's ongoing commitment to excellence and our technology alliances with key industry leaders such as Cisco Systems, EMC, Emerson, and IBM enables our highly skilled and knowledgeable global sales, systems engineering, and technical support teams to engage with critical customer challenges that range from initial problem determination all the way to resolution. Local specialists, trained to global standards and competencies, provide consistent regional support that brings value to local business. Our global value chain, which combines manufacturing, distribution, and service, provides prompt responses to customer-related issues, and streamlines procurement and delivery to any global destination.



Best-In-Class Partner Ecosystem

Panduit employs a consultative approach to identify customer needs and engage appropriate partners in a collaborative fashion to serve our customers. Panduit's robust ecosystem of architects, consultants, engineers, designers, systems integrators, contractors, and distributors offer a full portfolio of lifecycle services. Our partners are trained on relevant services to Plan & Design, Build & Deploy, and Maintain & Operate to deliver predictable and measurable results.



Worldwide Alliances

Panduit has established long-term strategic alliances with top global industry leaders such as Cisco Systems, EMC, HP, IBM, Liebert, and Rockwell Automation to develop and integrate innovative, holistic solutions for our customers. We continually invest in relationships and resources for solving our customers' greatest business challenges.



Eco-Sustainability & Global Citizenship

With a long-standing commitment to environmental excellence, Panduit continually develops and implements solutions designed to protect, replenish, and restore the world in which we live and operate. This commitment is demonstrated by Panduit's LEED Gold certified new world headquarters and future sustainable building plans using its own revolutionary Unified Physical InfrastructureSM approach to enable convergence of critical systems for driving energy efficiency.

*Transform Your
Physical Infrastructure
Call or visit us online,
we can show you how.*

Panduit Corp.
World Headquarters
Tinley Park, IL 60487

cs@panduit.com
US and Canada: 800.777.3300
Europe, Middle East, and Africa:
44.208.601.7200
Latin America: 52.33.3777.6000
Asia Pacific: 65.6305.7575

www.panduit.com

PANDUIT[®]