

LOC	DIST	REVISIONS			
		NO	DATE	BY	CHK
J	-	D	05DEC2007	T.K	M.K
		E	23JUL2010	T.T	T.M

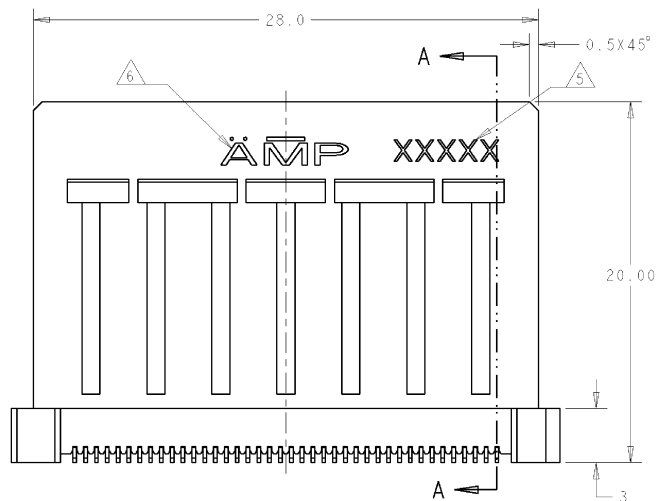

SECT A-A  
SCALE 8:1

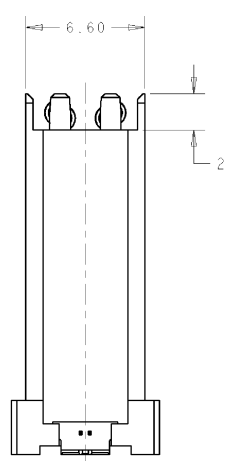
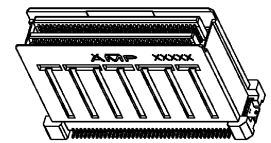
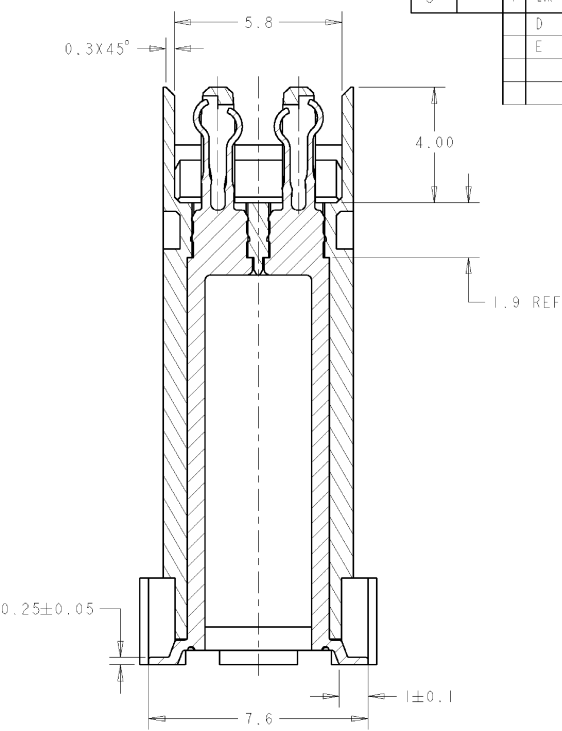
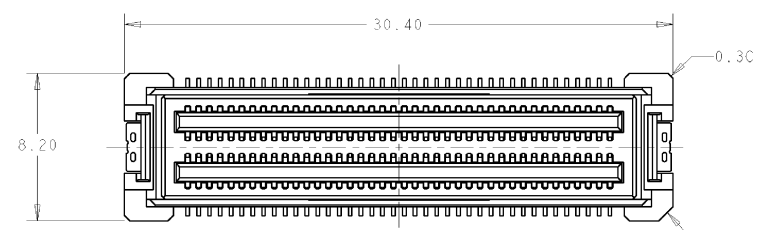
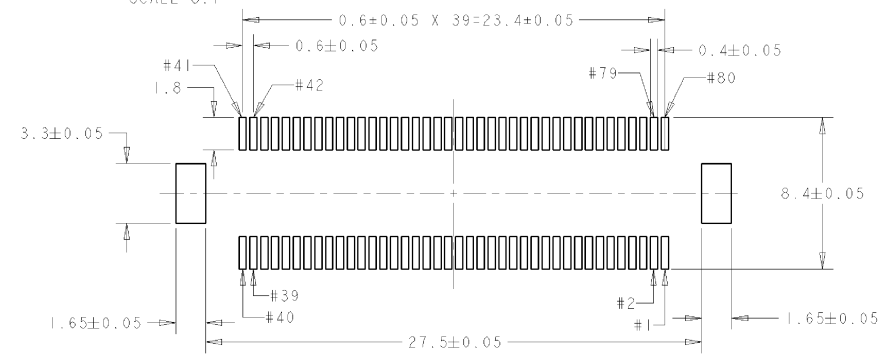
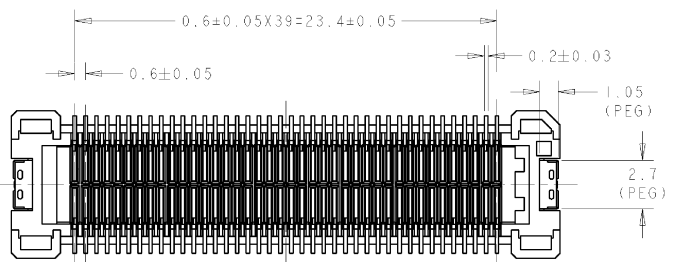

推奨基板取付寸法  
RECOMMENDED PCB LAYOUT

- 1 MATERIAL : HOUSING: LCP  
: CONTACT: COPPER ALLOY
- 2 FINISH : UNDER Ni PL. 0.8μmMIN  
: CONTACT AREA: Au PL. 0.3μmMIN  
: SOLDERING AREA: Au FLASH
- 3. COPLANARITY 0.1MAX.
- 4. -1 IS 45 CONNECTORS IN HARD TRAY.  
AND -2 IS 49 CONNECTORS IN HARD TRAY (SEE SHEET 2,3)
- 5. DATE CODE IS MARKED TO CHINA PRODUCTION PRODUCT.  
THE FACE SIDE AND BACK SIDE IS NOT ASKED.
- 6 AMP : MADE IN JAPAN  
AMP : MADE IN CHINA

- 1 材料:ハウジング : 液晶ポリマー  
: コンタクト : 銅合金
- 2 仕上り : 全面ニッケル下地 0.8μmMIN  
: 接点部 金メッキ 0.3μmMIN  
: 非点付部 金フラッシュ
- 3. コプラナリティー 0.1MAX
- 4. 梱包形態は、-1は45個入り、-2は49個入り(シート2,3参照)  
: 中国生産品に関しては、このエリアにテートコードが印字される。  
: ハウジングの表裏は問わない。
- 6 AMP : 日本生産品  
AMP : 中国生産品

<small>THIS DRAWING IS A CONTROLLED DOCUMENT FOR TYCO ELECTRONICS CORPORATION                  IT IS TO BE USED ONLY BY PERSONS AUTHORIZED BY THE ORGANIZATION                  SHOULD BE CONTACTED FOR THE LATEST REVISION.</small>		DWN : K. Sakai 23JAN2006 CHK : F. Takemasa 23JAN2006 APPV : M. Kimura 23JAN2006	Tyco Electronics Corporation Kawasaki, Japan
DIMENSIONS: mm	TOLERANCES UNLESS OTHERWISE SPECIFIED: 0 PLC ±0.3 1 PLC ±0.25 2 PLC ±0.2 3 PLC ±0.2 4 PLC ±0.2 ANGLES ±0.3	NAME: HDR ASSEMBLY 20mm HEIGHT 0.6mm PITCH 80P MICRO-STACK CONNECTOR	RESTRICTED TO: -
MATERIAL: SEE NOTE 1	FINISH: SEE NOTE 2	WEIGHT: 3.9g CUSTOMER DRAWING	SIZE: A2 CAGE CODE: 00779 DRAWING NO: 6376609 SCALE: 5:1 SHEET 1 OF 2 REV E

THIS DRAWING IS UNPUBLISHED. RELEASED FOR PUBLICATION 2006  
 © COPYRIGHT 2006 BY TYCO ELECTRONICS CORPORATION. ALL RIGHTS RESERVED.

LOC	DIST	REVISIONS			
P	LTR	DESCRIPTION	DATE	DWN	APVD
J	-	-	-	-	-

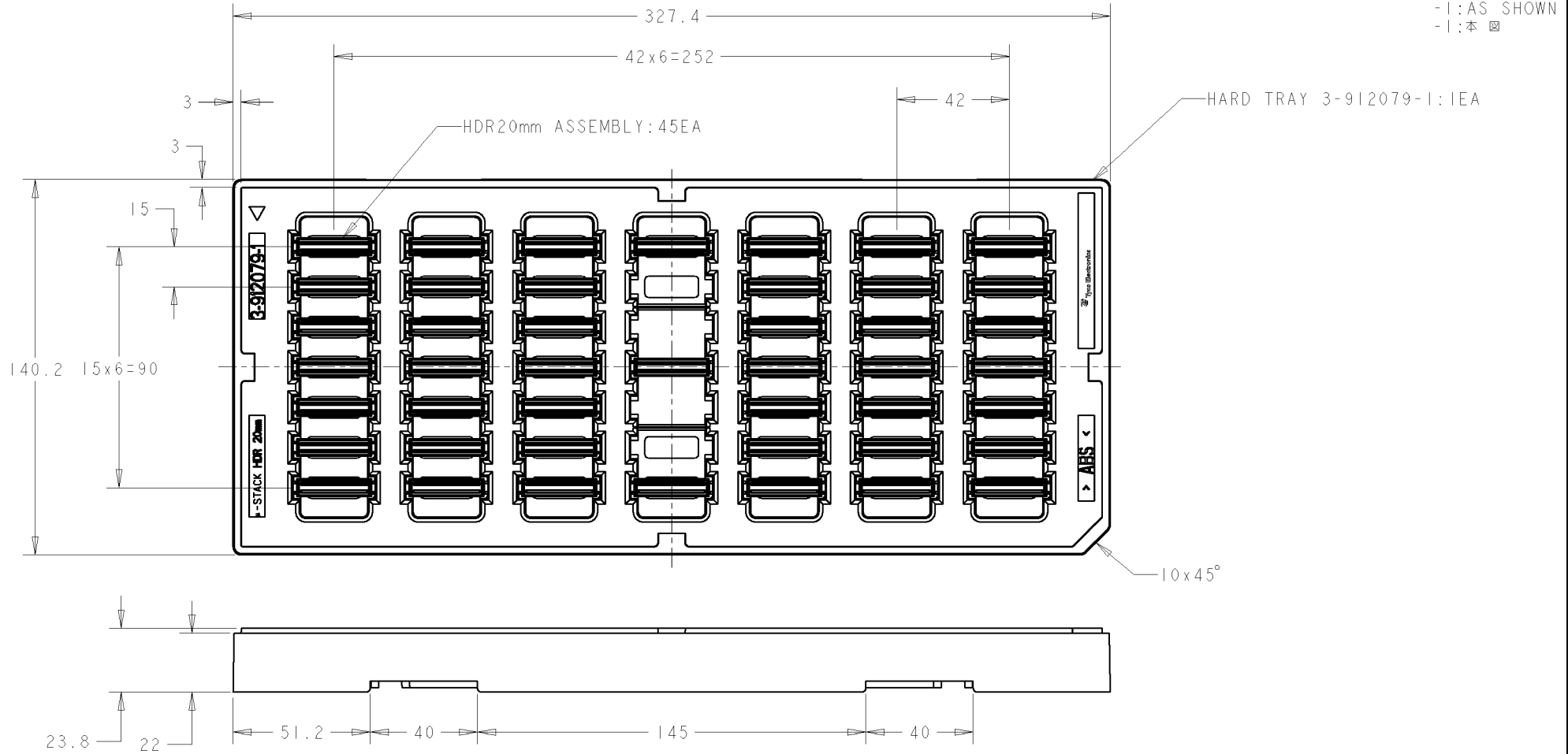

Fig 1: HARD TRAY PACKING SPEC

45	BLACK
CONN QTY	HARD TRAY COLOR

<small>THIS DRAWING IS A CONTROLLED DOCUMENT FOR TYCO ELECTRONICS CORPORATION. IT IS SUBJECT TO CHANGE AND THE CONTROLLING ENGINEERING ORGANIZATION SHOULD BE CONTACTED FOR THE LATEST REVISION.</small>		DWN <u>K. Sakai</u> 23JAN2006 CHK <u>E. Takemasa</u> 23JAN2006 APVD <u>M. Kimura</u> 23JAN2006		<b>Tyco Electronics</b> Tyco Electronics Corporation Kawasaki, Japan	
DIMENSIONS: mm		TOLERANCES UNLESS OTHERWISE SPECIFIED: 0. PLC ± 1. PLC ± 2. PLC ± 3. PLC ± 4. PLC ± ANGLES ±		NAME HDR ASSEMBLY 20mm HEIGHT 0.6mm PITCH 80P MAICRO-STACK CONNECTOR	
MATERIAL -		FINISH -		PRODUCT SPEC 108-5724	
		APPLICATION SPEC -		SIZE CAGE CODE DRAWING NO A3 00779 C=6376609	
		WEIGHT -		RESTRICTED TO -	
CUSTOMER DRAWING				SCALE 2:3 SHEET 2 OF 2 REV E	