

SMD Schottky Barrier Diode



SMD Diodes Specialist

CDBF0540 (RoHS Device)

$I_o = 500 \text{ mA}$

$V_R = 40 \text{ Volts}$



Features

- Low forward voltage.
- Designed for mounting on small surface.
- Extremely thin / leadless package.
- Majority carrier conduction.

Mechanical data

- Case: 1005(2512) standard package, molded plastic.
- Terminals: Gold plated, solderable per MIL-STD-750, method 2026.
- Marking code: cathode band & BN
- Mounting position: Any
- Weight: 0.006 gram (approx.).

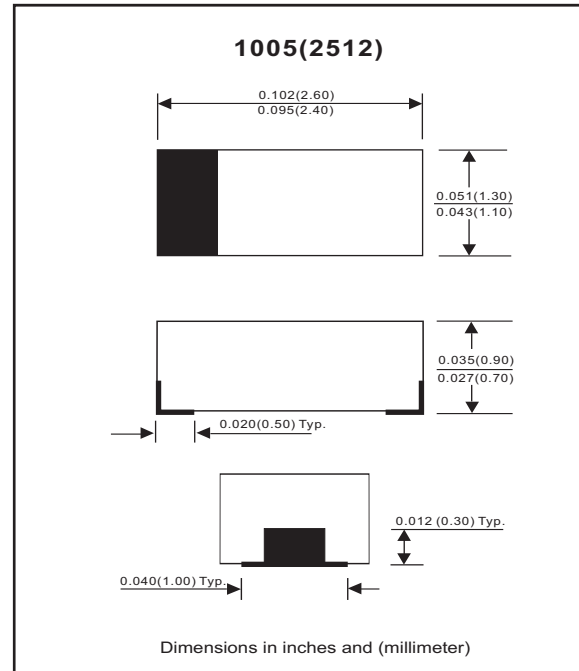

Maximum Rating (at $T_A=25^\circ\text{C}$ unless otherwise noted)

Parameter	Conditions	Symbol	Min	Typ	Max	Unit
Peak reverse voltage		V_{RM}			40	V
Reverse voltage		V_R			40	V
Average forward rectified current		I_o			500	mA
Forward current, surge peak	8.3 ms single half sine-wave superimposed on rate load (JEDEC method)	I_{FSM}			5.5	A
Storage temperature		T_{STG}	-40		+125	$^\circ\text{C}$
Junction temperature		T_j			+125	$^\circ\text{C}$

Electrical Characteristics (at $T_A=25^\circ\text{C}$ unless otherwise noted)

Parameter	Conditions	Symbol	Min	Typ	Max	Unit
Forward voltage	$I_F = 0.5 \text{ A}$ @ $T_a = 25^\circ\text{C}$ $I_F = 1 \text{ A}$ @ $T_a = 25^\circ\text{C}$ $I_F = 0.5 \text{ A}$ @ $T_a = 100^\circ\text{C}$ $I_F = 1 \text{ A}$ @ $T_a = 100^\circ\text{C}$	V_F			0.51 0.64 0.46 0.62	V
Reverse current	$V_R = 20 \text{ V}$ @ $T_a = 25^\circ\text{C}$ $V_R = 40 \text{ V}$ @ $T_a = 25^\circ\text{C}$ $V_R = 20 \text{ V}$ @ $T_a = 100^\circ\text{C}$ $V_R = 40 \text{ V}$ @ $T_a = 100^\circ\text{C}$	I_R			0.01 0.02 2 5	mA
Capacitance between terminals	$f = 1 \text{ MHz}$, and 0 VDC reverse voltage	C_T			170	pF
Reverse recovery time	$I_F = I_R = 10 \text{ mA}$, $I_{rr} \times I_R$, $R_L = 100 \text{ ohm}$	T_{rr}		22		ns

REV:B

RATING AND CHARACTERISTIC CURVES (CDBF0540)

Fig. 1 - Forward characteristics

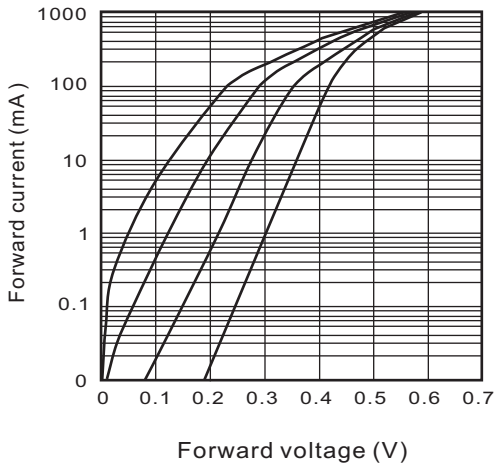

Fig. 2 - Reverse characteristics

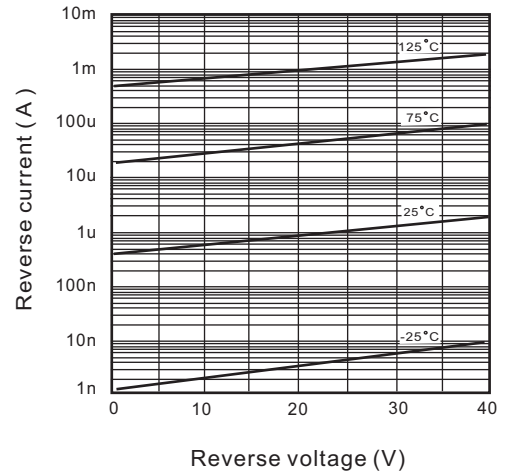

Fig. 3 - Capacitance between terminals characteristics

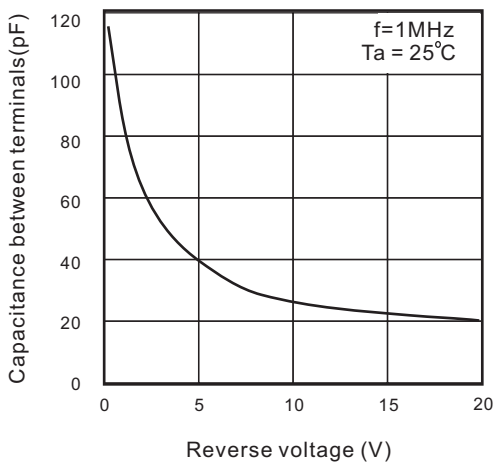
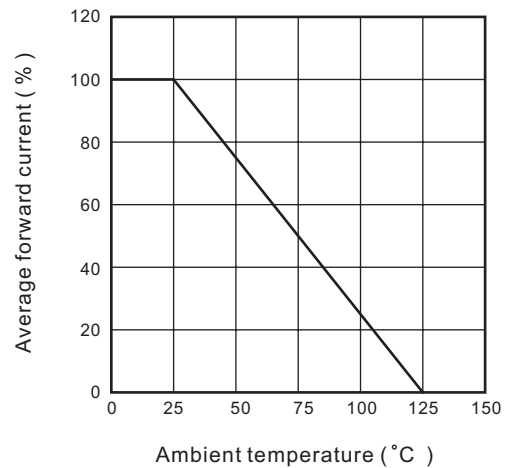
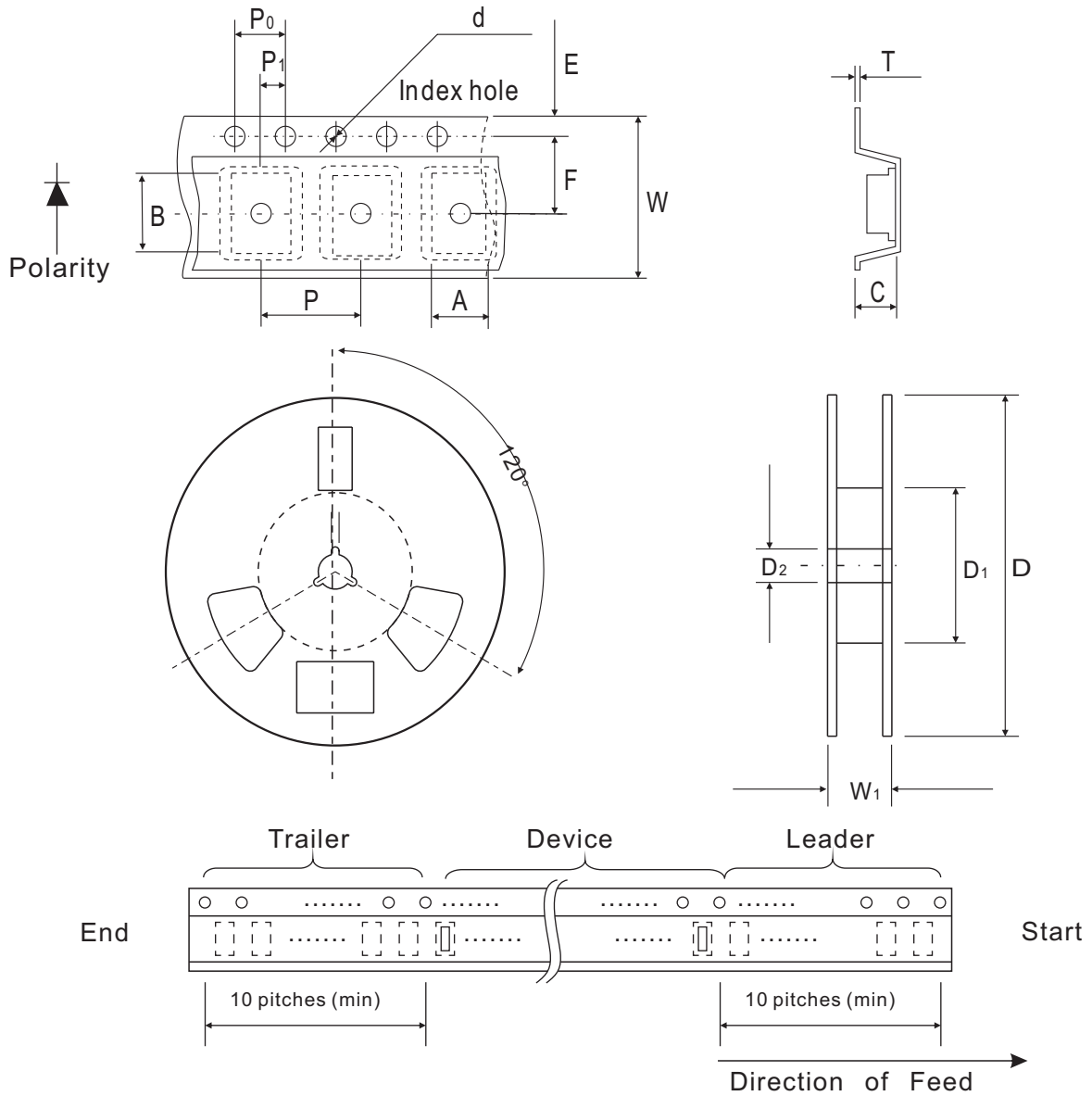

Fig. 4 - Current derating curve



Reel Taping Specification



F/1005	SYMBOL	A	B	C	d	D	D ₁	D ₂
	(mm)	1.55 ± 0.10	2.65 ± 0.10	1.05 ± 0.10	1.55 ± 0.05	178 ± 1	60.0 MIN.	13.0 ± 0.20
	(inch)	0.061 ± 0.004	0.104 ± 0.004	0.041 ± 0.004	0.061 ± 0.002	7.008 ± 0.04	2.362 MIN.	0.512 ± 0.008

F/1005	SYMBOL	E	F	P	P ₀	P ₁	T	W	W ₁
	(mm)	1.75 ± 0.10	3.50 ± 0.05	4.00 ± 0.10	4.00 ± 0.10	2.00 ± 0.05	0.23 ± 0.05	8.00 ± 0.20	13.5 MAX.
	(inch)	0.069 ± 0.004	0.138 ± 0.002	0.157 ± 0.004	0.157 ± 0.004	0.079 ± 0.004	0.009 ± 0.002	0.315 ± 0.008	0.531 MAX.

Marking Code

Part Number	Marking Code
CDBF0540	BN



Suggested PAD Layout

SIZE	F/1005	
	(mm)	(inch)
A	2.10	0.083
B	1.20	0.047
C	1.20	0.047
D	3.30	0.130
E	0.90	0.035

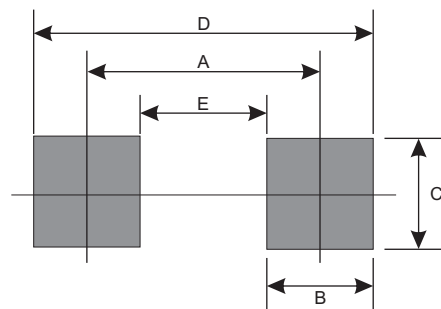

Standard Package

Case Type	Qty per Reel	Reel Size
	(Pcs)	(inch)
F/1005	4000	7