

Cylindrical High-Intensity LED (5 mm)

OVLLx8C7

- Wide viewing angle
- High-brightness indicator
- Industry standard lead spacing
- Unique lens shape for flexible applications

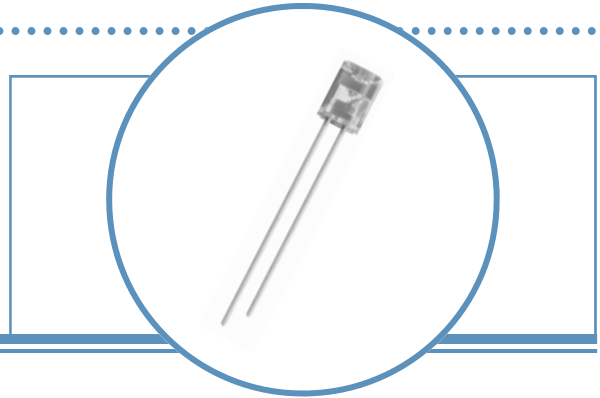

The **OVLLx8C7** series is designed for superior performance in signage and lighting applications that require wide-angle uniform light output. These devices combine a high-intensity LED with a unique flat-topped T-1 $\frac{3}{4}$ package to provide both high brightness and a wide spatial radiation pattern.

Applications

- Channel letter and other signage backlighting
- Decorative architectural indoor and outdoor lighting accents
- Industrial and consumer indicators

Part Number	Material	Emitted Color	Intensity Typ. mcd	Lens Color
OVLLB8C7	InGaN	Blue	300	Water Clear
OVLLG8C7	InGaN	Green	670	Water Clear
OVLLR8C7	AllnGaP	Red	570	Water Clear
OVLly8C7	AllnGaP	Yellow	650	Water Clear

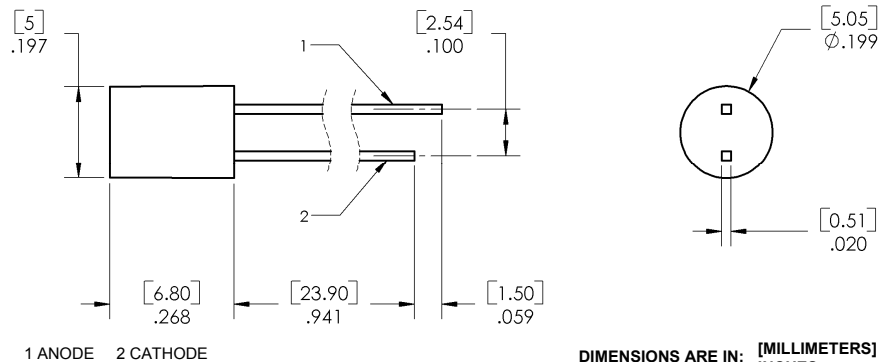

DIMENSIONS ARE IN: [MILLIMETERS]
INCHES



**DO NOT LOOK DIRECTLY
AT LED WITH UNSHIELDED
EYES OR DAMAGE TO
RETINA MAY OCCUR.**

OPTEK reserves the right to make changes at any time in order to improve design and to supply the best product possible.

Cylindrical High-Intensity LED

OVLLx8C7



Absolute Maximum Ratings

T_A = 25° C unless otherwise noted

Storage Temperature Range	All	-40 ~ +100° C
Operating Temperature Range	All	-40 ~ +85° C
Reverse Voltage	All	5 V
Continuous Forward Current	Blue, Green	20 mA
	Red, Yellow	30 mA
Peak Forward Current (10% Duty Cycle, 1 KHz)	Blue, Green	50 mA
	Red, Yellow	100 mA
Power Dissipation	Blue, Green	80 mW
	Red, Yellow	78 mW
Lead Soldering Temperature (4 mm from the base of the epoxy bulb) ¹	All	260° C
LED Junction Temperature	All	125° C
Current Linearity vs. Ambient Temperature	Blue, Green	-0.2 mA/° C
	Red, Yellow	-0.5 mA/° C

Note:

- Solder time less than 5 seconds at temperature extreme.

Electrical Characteristics

T_A = 25° C unless otherwise noted

SYMBOL	PARAMETER	COLOR	MIN	TYP	MAX	UNITS	CONDITIONS
I _v	Luminous Intensity	Blue	170	300	----	mcd	I _F = 20 mA
		Green	415	670	----		
		Red	415	570	----		
		Yellow	470	650	----		
V _F	Forward Voltage	Blue, Green	----	3.4	4.0	V	I _F = 20 mA
		Red, Yellow	----	2.2	2.6		
I _R	Reverse Current	Blue, Green	----	----	50	μA	V _R = 5 V
		Red, Yellow	----	----	10		
λ _P	Peak Wavelength	Blue	----	466	----	nm	I _F = 20 mA
		Green	----	521	----		
		Red	----	633	----		
		Yellow	----	593	----		
λ _D	Dominant Wavelength	Blue	----	470	----	nm	I _F = 20 mA
		Green	----	525	----		
		Red	----	623	----		
		Yellow	----	589	----		
2Θ _{1/2} H-H	50% Power Angle	All	----	85	----	deg	I _F = 20 mA

OPTEK reserves the right to make changes at any time in order to improve design and to supply the best product possible.

Cylindrical High-Intensity LED

OVLLx8C7

Beam Pattern

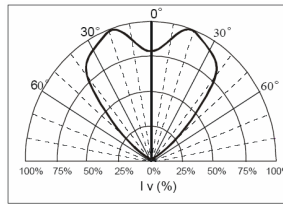

Standard Bins ($I_F = 20 \text{ mA}$)

Lamps are sorted to luminous intensity (I_V) and dominant wavelength (λ_D) bins shown. Orders may be filled with any or all bins contained as below.

OVLBGD8 (BLUE)

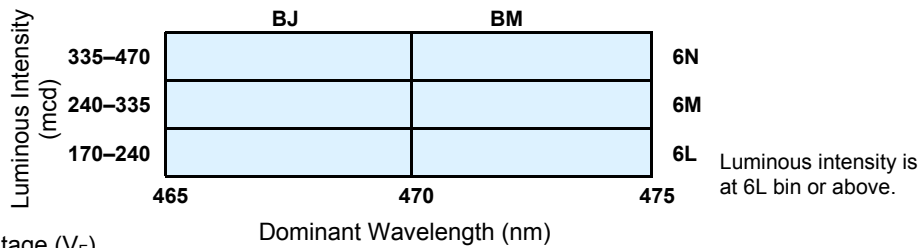

Forward Voltage (V_F)

Rank	H	J	K	L
Voltage	2.6–3.0	3.0–3.3	3.3–3.6	3.6–4.0

OVLKGGD8 (GREEN)

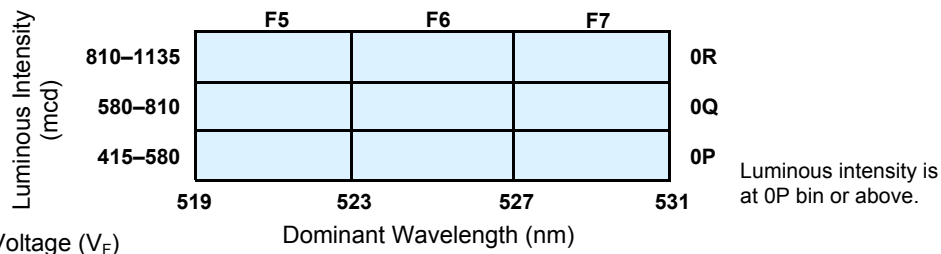

Forward Voltage (V_F)

Rank	H	J	K	L
Voltage (V)	2.6–3.0	3.0–3.3	3.3–3.6	3.6–4.0

OVLJRGD8 (RED)

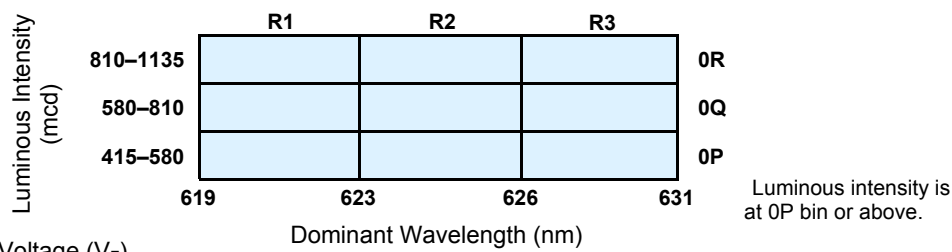

Forward Voltage (V_F)

Rank	G	H	J	6
Voltage	1.8–2.0	2.0–2.2	2.2–2.4	2.4–2.6

Important Notes:

- All ranks will be included per delivery, rank ratio will be based on the chip distribution.
- To designate luminous intensity ranks, please contact OPTEK.
- Pb content <1000 PPM.

OPTEK reserves the right to make changes at any time in order to improve design and to supply the best product possible.

Cylindrical High-Intensity LED

OVLLx8C7

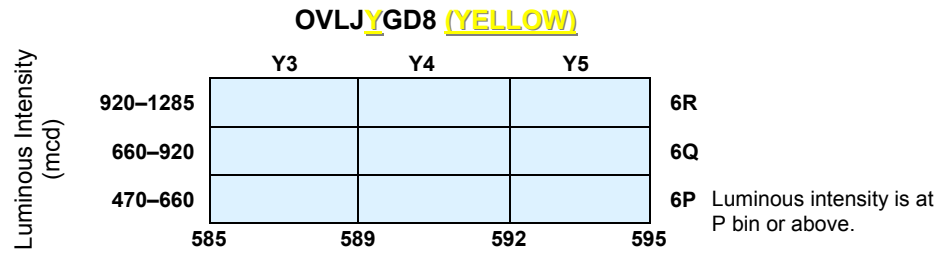

Forward Voltage (V _F)	Dominant Wavelength (nm)			
Rank	G	H	J	6
Voltage	1.8–2.0	2.0–2.2	2.2–2.4	2.4–2.6

Important Notes:

1. All ranks will be included per delivery, rank ratio will be based on the chip distribution.
2. To designate luminous intensity ranks, please contact OPTEK.
3. Pb content <1000 PPM.

OPTEK reserves the right to make changes at any time in order to improve design and to supply the best product possible.

Typical Electro-Optical Characteristics Curves (BLUE)

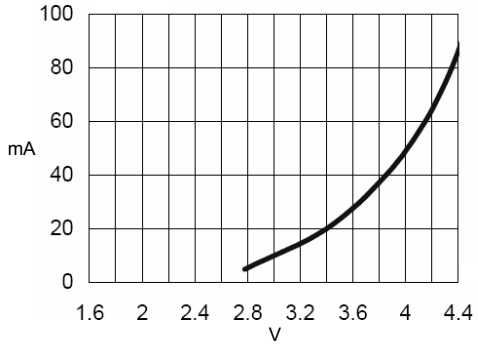

Forward Current vs Forward Voltage

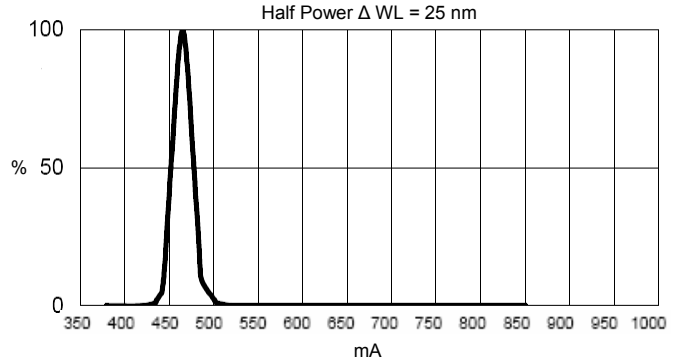

Relative Luminous Intensity vs Wavelength

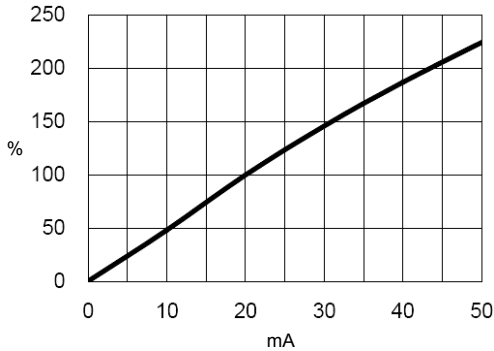

Relative Luminous Intensity vs Forward Current

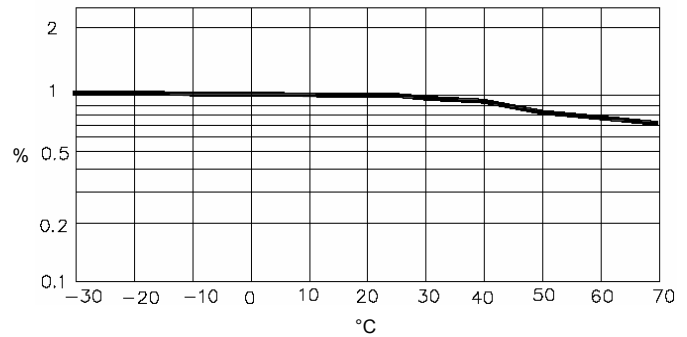

Relative Luminous Intensity vs Ambient Temperature

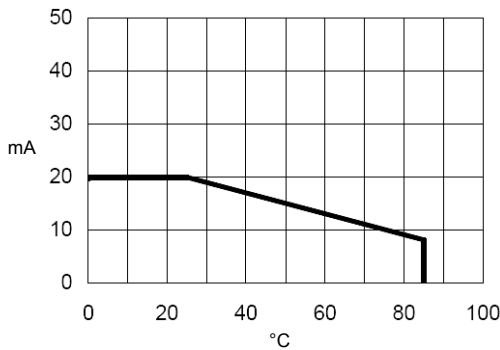

Forward Current vs Ambient Temperature

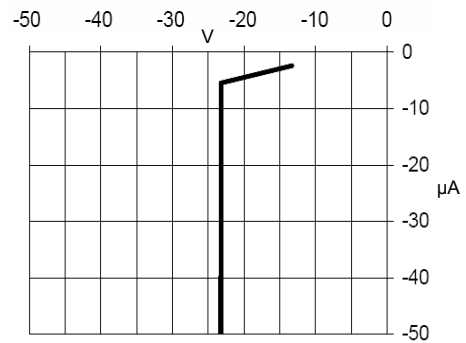

Reverse Current vs Reverse Voltage

OPTEK reserves the right to make changes at any time in order to improve design and to supply the best product possible.

Typical Electro-Optical Characteristics Curves (GREEN)

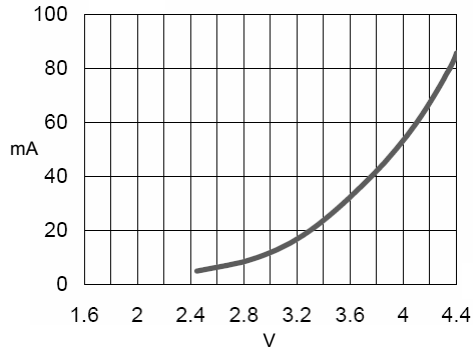

Forward Current vs Forward Voltage

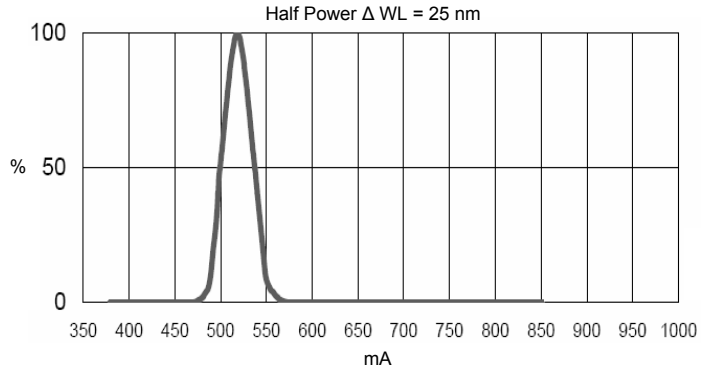

Relative Luminous Intensity vs Wavelength

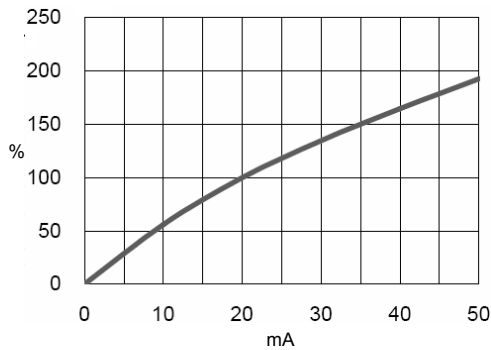

Relative Luminous Intensity vs Forward Current

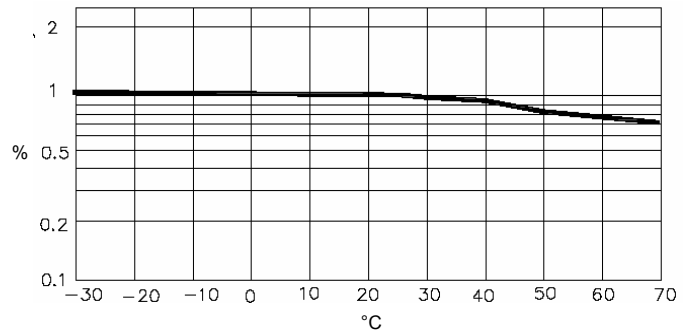

Relative Luminous Intensity vs Ambient Temperature

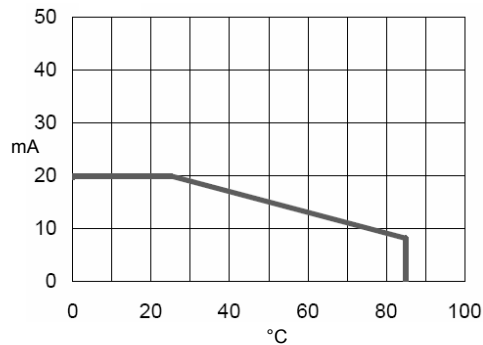

Forward Current vs Ambient Temperature

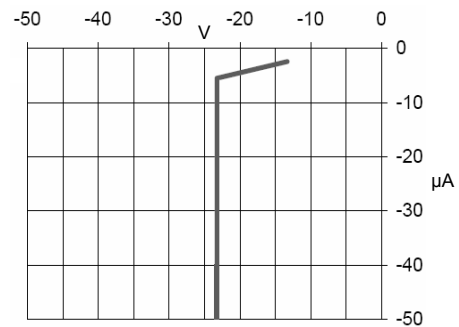

Reverse Current vs Reverse Voltage

OPTEK reserves the right to make changes at any time in order to improve design and to supply the best product possible.

Typical Electro-Optical Characteristics Curves (RED)

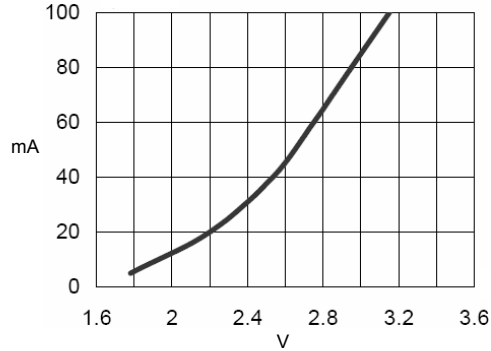

Forward Current vs Forward Voltage

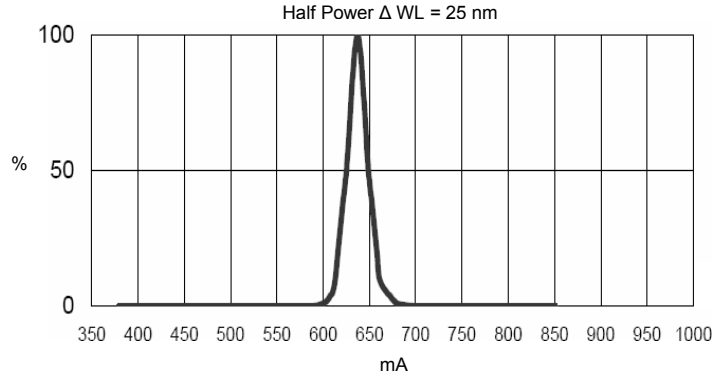

Relative Luminous Intensity vs Wavelength

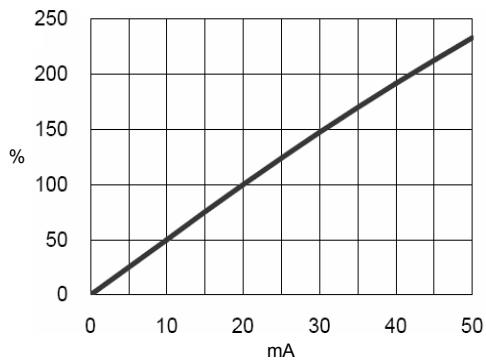

Relative Luminous Intensity vs Forward Current

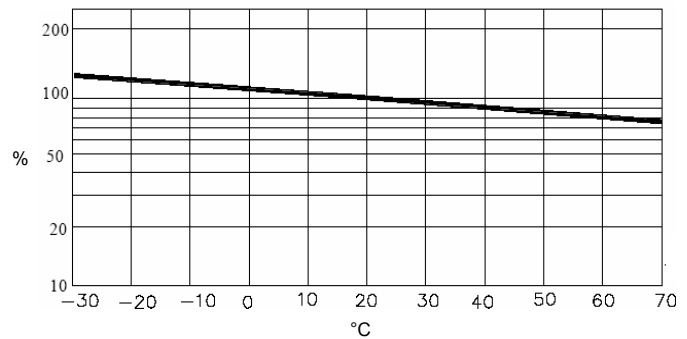

Relative Luminous Intensity vs Ambient Temperature

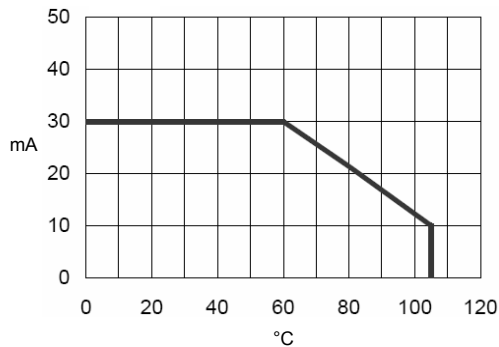

Forward Current vs Ambient Temperature

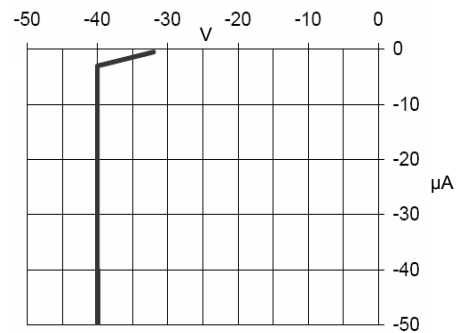

Reverse Current vs Reverse Voltage

OPTEK reserves the right to make changes at any time in order to improve design and to supply the best product possible.

Typical Electro-Optical Characteristics Curves (YELLOW)

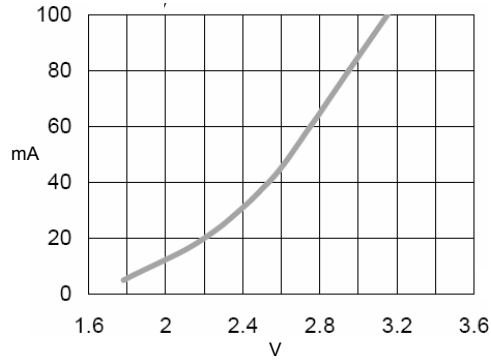

Forward Current vs Forward Voltage

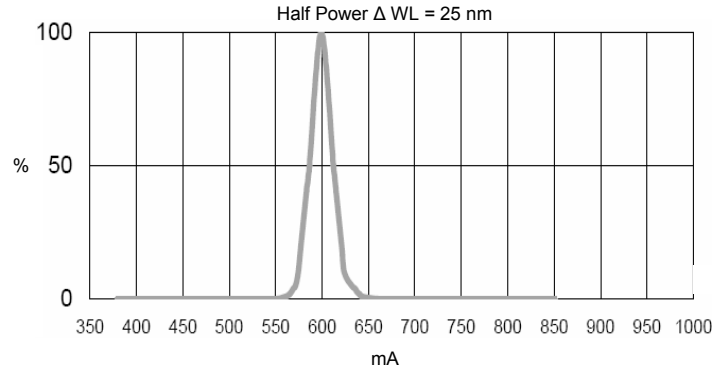

Relative Luminous Intensity vs Wavelength

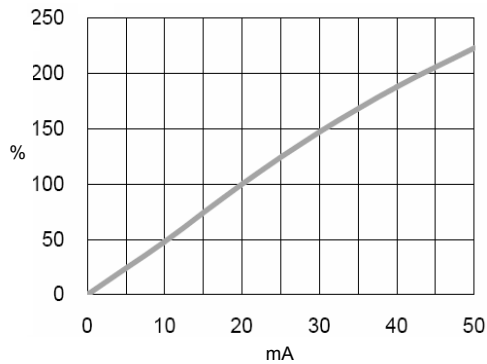

Relative Luminous Intensity vs Forward Current

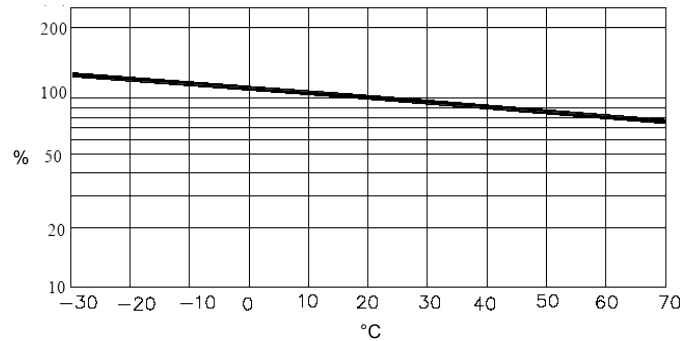

Relative Luminous Intensity vs Ambient Temperature

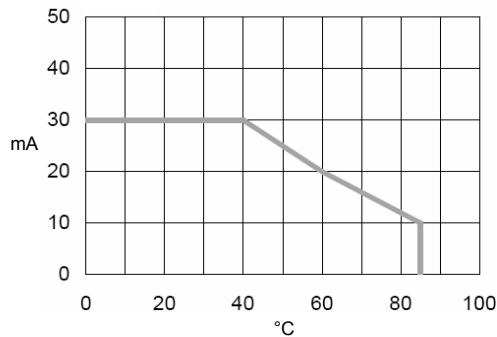

Forward Current vs Ambient Temperature

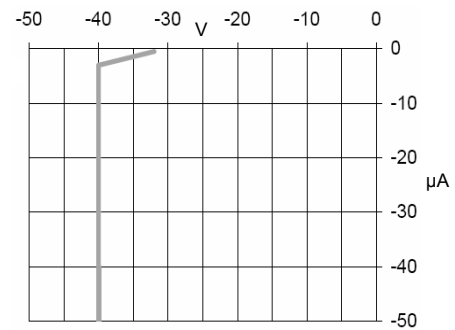

Reverse Current vs Reverse Voltage

OPTEK reserves the right to make changes at any time in order to improve design and to supply the best product possible.

Cylindrical High-Intensity LED OVLLx8C7

Packing Information: Available in bulk or reel



Bulk: 500 pcs/bag

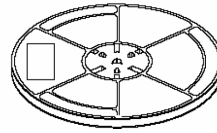

13-inch reel: 2000 pcs/reel

Carrier Tape Dimensions: Loaded quantity 2000 pieces per reel

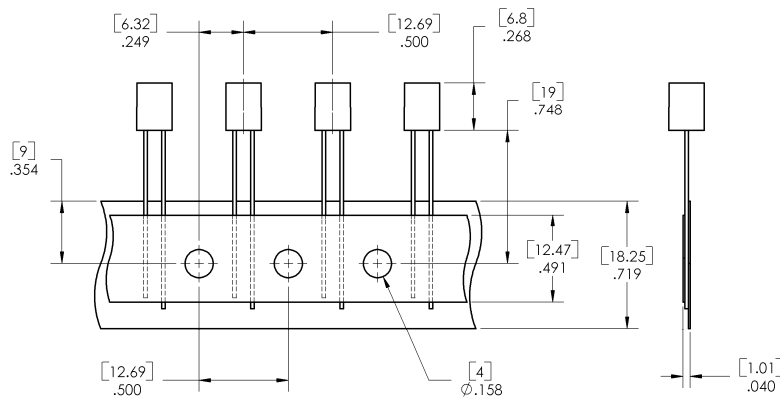

DIMENSIONS ARE IN INCHES AND [MILLIMETERS].

Moisture Resistant Packaging

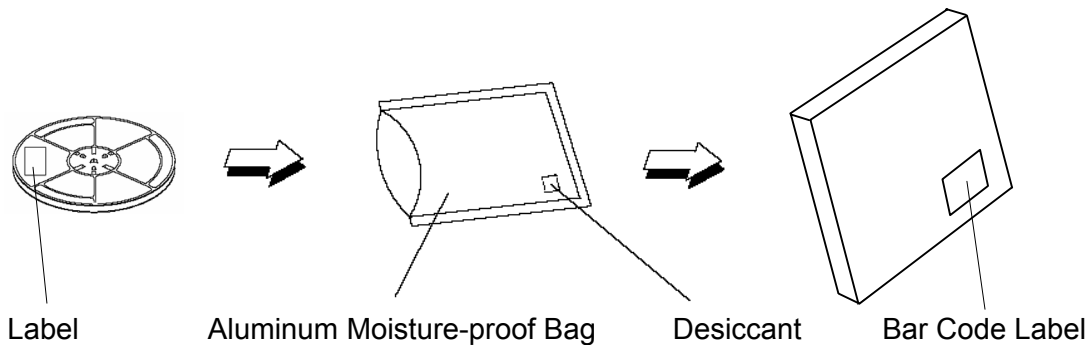

OPTEK reserves the right to make changes at any time in order to improve design and to supply the best product possible.