

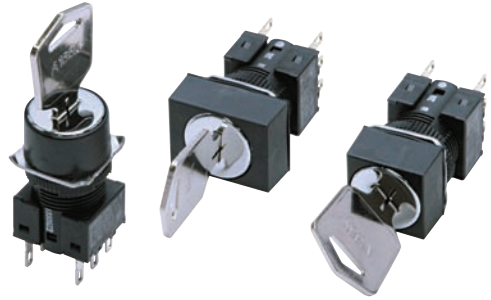

A165K



Separate Construction with Cylindrical 16-dia. Body

- Short mounting depth, less than 28.5 mm below panel
- Wide range of switching capacity from standard to microload
- Oil-resistant IP65 models

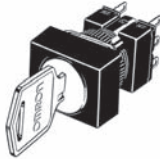
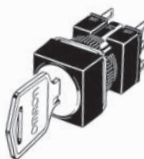

 Refer to *Safety Precautions for All Pushbutton Switches/ Indicators* and *Safety Precautions* on page 11.

List of Models

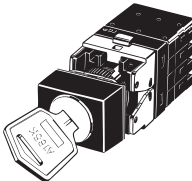
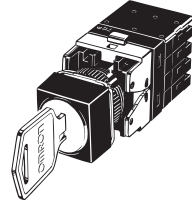
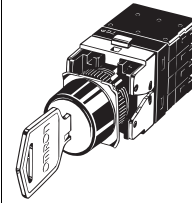
	Model		
	Rectangular	Square	Round
Solder terminals	 <p>A165K-J Series</p>	 <p>A165K-A Series</p>	 <p>A165K-T Series</p>
Screwless clamp connector	 <p>A165K-J Series</p>	 <p>A165K-A Series</p>	 <p>A165K-T Series</p>

Model Number Structure

Model Number Legend The model numbers used to order sets of Units are illustrated below. One set comprises the Selector, Switch, and 2 Keys.
For information on combinations, refer to *Ordering Information* on page 3.

A 1 6 5 K - ⁽¹⁾ J ⁽²⁾ 3 M L - ⁽³⁾ 2

(1) Shape of Selector

Symbol	Shape	Color
J	Rectangular	Black
A	Square	
T	Round	

(2) Number of Notches/Resetting Method

Symbol	No. of notches	Reset method	Key release position
2ML	2 notches	Manual	Left
2MR			Right
2M			Left and right
2AL	3 notches	Automatic	Left
3MC		Manual	Center
3MR			Right
3ML			Left
3M			Left, right, and center
3AC	3 notches	Automatic	Center

(3) Contact Configuration

Symbol	Type	Terminal
1	SPDT	Solder Terminal
2	DPDT	
2S	DPDT	Screw-less Clamp

Note: Only DPDT contacts are available with 3-notch models.

Ordering Information

Ordering as a Set The model numbers used to order sets of Units are given in the following tables. One set comprises the Selector, Switch and 2 Keys.

Solder Terminals

Rectangular Models



Oil-resistant IP65

Number of notches	Output	Reset method	Key release position	Model
2 notches	SPDT	Manual	Left	A165K-J2ML-1
			Right	A165K-J2MR-1
			Left and right	A165K-J2M-1
	DPDT	Automatic	Left	A165K-J2AL-1
			Left	A165K-J2ML-2
			Right	A165K-J2MR-2
DPDT	Manual	Left and right	A165K-J2M-2	
		Left	A165K-J2AL-2	
		Left	A165K-J3MC-2	
3 notches	DPDT	Manual	Right	A165K-J3MR-2
			Left	A165K-J3ML-2
			Left, right, and center	A165K-J3M-2

Square Models



Oil-resistant IP65

Number of notches	Output	Reset method	Key release position	Model
2 notches	SPDT	Manual	Left	A165K-A2ML-1
			Right	A165K-A2MR-1
			Left and right	A165K-A2M-1
	DPDT	Automatic	Left	A165K-A2AL-1
			Left	A165K-A2ML-2
			Right	A165K-A2MR-2
DPDT	Manual	Left and right	A165K-A2M-2	
		Left	A165K-A2AL-2	
		Left	A165K-A3MC-2	
3 notches	DPDT	Manual	Right	A165K-A3MR-2
			Left	A165K-A3ML-2
			Left, right, and center	A165K-A3M-2

Round Models





Oil-resistant IP65



Number of notches	Output	Reset method	Key release position	Model
2 notches	SPDT	Manual	Left	A165K-T2ML-1
			Right	A165K-T2MR-1
			Left and right	A165K-T2M-1
	DPDT	Automatic	Left	A165K-T2AL-1
			Left	A165K-T2ML-2
			Right	A165K-T2MR-2
DPDT	Manual	Left and right	A165K-T2M-2	
		Left	A165K-T2AL-2	
		Left	A165K-T3MC-2	
3 notches	DPDT	Manual	Right	A165K-T3MR-2
			Left	A165K-T3ML-2
			Left, right, and center	A165K-T3M-2

Ordering Information

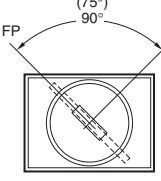
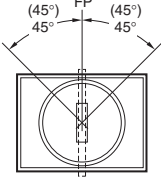
Ordering Individually Selectors and Switches can be ordered separately. Combinations that are not available as sets can be created using individual Units. Also, store the parts as spares for maintenance and repairs.

Operation Units (Listed on Page 5.)			
<p>Rectangular (A165K-J)</p> 	<p>Square (A165K-A)</p> 	<p>Round (A165K-T)</p> 	<p>(Standard condition when shipped)</p> <div style="display: flex; justify-content: space-around;"> <div style="text-align: center;"> <p>Switches with 2 Notches</p> <p>(75°) 90°</p>  </div> <div style="text-align: center;"> <p>Switches with 3 Notches</p> <p>(45°) FP (45°) 45°</p>  </div> </div> <p>Note: The figures in parentheses are for self-resetting models. FP: Free position</p>
<p>Two keys are provided.</p>			

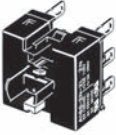
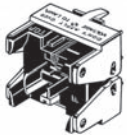



Switches (Listed on Page 5.)		
<p>Solder terminals</p> 	<p>PCB terminals</p> 	<p>Screw-less clamp connector</p> 



Ordering Information

Ordering Individually Selectors and Switches can be ordered separately. Combinations that are not available as sets can be created using individual Units. Also, store the parts as spares for maintenance and repairs.

Selectors

Appearance	Number of notches	Reset method	Key release position	Model
Rectangular (A165K-J) 	2 notches	Manual	⊘	A165K-J2ML
			⊙	A165K-J2MR
		Automatic	⊗	A165K-J2M
			⊖	A165K-J2AL
	3 notches	Manual	⊖	A165K-J3MC
			⊙	A165K-J3MR
			⊘	A165K-J3ML
		Automatic	⊗	A165K-J3M
			⊖	A165K-J3AC
			⊖	A165K-J3AC
Square (A165K-A) 	2 notches	Manual	⊘	A165K-A2ML
			⊙	A165K-A2MR
		Automatic	⊗	A165K-A2M
			⊖	A165K-A2AL
	3 notches	Manual	⊖	A165K-A3MC
			⊙	A165K-A3MR
			⊘	A165K-A3ML
		Automatic	⊗	A165K-A3M
			⊖	A165K-A3AC
			⊖	A165K-A3AC
Round (A165K-T) 	2 notches	Manual	⊘	A165K-T2ML
			⊙	A165K-T2MR
		Automatic	⊗	A165K-T2M
			⊖	A165K-T2AL
	3 notches	Manual	⊖	A165K-T3MC
			⊙	A165K-T3MR
			⊘	A165K-T3ML
		Automatic	⊗	A165K-T3M
			⊖	A165K-T3AC
			⊖	A165K-T3AC

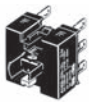
Switches

Appearance	Classification			Model	
	Switches	2 notches	SPDT	Solder terminal	A16S-2N-1
			DPDT		A16S-2N-2
		3 notches	DPDT	A16S-3N-2	
		2 notches	SPDT	PCB terminal	A16S-2N-1P
			DPDT		A16S-2N-2P

Switch Units with Screw-less Clamp Connectors

Appearance	Classification			Model	Remarks	
	Common to standard load and microload.	DPDT	2 notches	Non-lighted	A16-2S	Common to ones for pushbutton switches.
			3 notches		A16S-3N-2LS	



Ordering Information

Accessories and Tools (Order Separately)

Accessories

Name	Appearance	Classification	Model	Remarks
Panel Plugs		Rectangular	A16ZJ-3003	Used for covering the panel cutouts for future panel expansion. Degree of protection: IP40 Color: Black
		Square	A16ZA-3003	
		Round	A16ZT-3003	

Tools

Name	Appearance	Model	Applicable types					Remarks
			Pushbutton Switch	Knob-type Selector Switch	Key-type Selector Switch	Emergency Stop Switch	Indicator	
Screw Fitting		A16Z-3004	Yes	Yes	Yes	Yes	Yes	Convenient for ganged installation.
Extractor		A16Z-5080	Yes	Yes	Yes	Yes	Yes	Convenient for extracting the Lamp from a Solder-terminal Socket Unit.

Key

Appearance	Model
	A165K-KEY

Note: Two Keys are provided.

Ordering as a Set: Refer to page 3.

- Specifications, and dimensions: Refer to page 7 to 10.
- Accessories, replacements, and tools: Refer to this page.

Specifications

Approved Standard Ratings

UL, cUL (File No. E41515)

5 A at 125 VAC, 3 A at 250 VAC (general use)
3 A at 30 VDC (resistive)

Note: Certification has been obtained for the Switch Unit.
For detailed information on individual products that have received certification, consult your supplier.

TÜV (EN60947-5-1) (Low Voltage Directive)

3 A at 250 VAC
3 A at 30 VDC

CCC (GB14048.5)

5 A at 125 VAC
3 A at 250 VAC
3 A at 30 VDC

Ratings

Contacts

Rated voltage	Resistive load
125 VAC	5 A
250 VAC	3 A
30 VDC	3 A

Minimum applicable load: 1 mA at 5 VDC

Rated values are obtained from tests conducted under the following conditions.

1. Load: Resistive load
2. Mounting conditions: No vibration and no shock
3. Temperature: 20±2°C
4. Operating frequency: 20 times/min

Contact Form

Name	Contact form
SPDT	

Characteristics

Socket Units

Item	Type	Key-type Selector Switch
Allowable operating frequency	Mechanical	20 operations/minute max.
	Electrical	10 operations/minute max.
Insulation resistance		100 MΩ min. (at 500 VDC)
Contact resistance		100 mΩ max. (initial value)
Dielectric strength	Between terminals of same polarity	1,000 VAC, 50/60 Hz for 1 minute
	Between terminals of different polarity	2,000 VAC, 50/60 Hz for 1 minute
	Between each terminal and ground	2,000 VAC, 50/60 Hz for 1 minute
Vibration resistance	Malfunction	10 to 55 Hz, 1.5-mm double amplitude (malfunction within 1 ms)
Shock resistance	Destruction	500 m/s ² max.
	Malfunction	150 m/s ² max. (malfunction within 1 ms)
Durability	Mechanical	250,000 operations min. (durability of key: 10,000 operations min.)
	Electrical	100,000 operations min.
Electric shock protection class		Class II
PTI (tracking characteristic)		175
Degree of contamination		3 (IEC60947-5-1)
Weight		Approx. 26.5 g (in the case of a DPDT switch key)
Ambient operating temperature		-10°C to 55°C (with no icing or condensation)
Ambient operating humidity		35% to 85%RH
Ambient storage temperature		-25°C to 65°C (with no icing or condensation)

Screw-less Clamp

Item	Type	Screw-less Clamp			
Recommended wire size		0.5 mm ² twisted wire or 0.8 mm-dia. solid wire			
Usable wires and tensile strength	Twisted wire	0.3 mm ²	0.5 mm ²	0.75 mm ²	1.25 mm ²
	Solid wire	0.5 mm dia.	0.8 mm dia.	1.0 mm dia.	---
	Tensile strength	10 N	20 N	30 N	40 N
Length of exposed wire		10 ±1 mm			
Compliant standards		JIS C 2811 Terminal Blocks for Industrial Use			

Operating Characteristics

Characteristics	Type	Key-type Selector Switch	
		2 notches	3 notches
Operating torque (OF) max.		0.1 N·m	
Set position (SP)		90±5°	45° ⁺¹⁰ ₀

Operation Angle

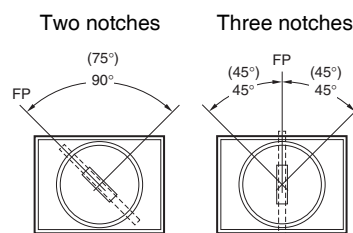

Note: The angle used for automatic reset is shown in parentheses.
FP: Free position

Contact Configuration

No. of notches	Contact configuration				
	SPDT		DPDT		
	Position	SW	Position	SW2	SW1
2 notches					
3 notches	---	---			
	---	---			
	---	---			

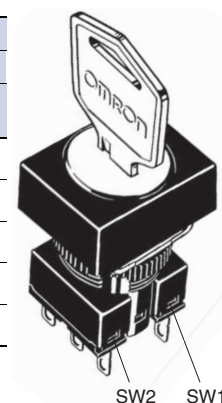

Nomenclature

Model Structure

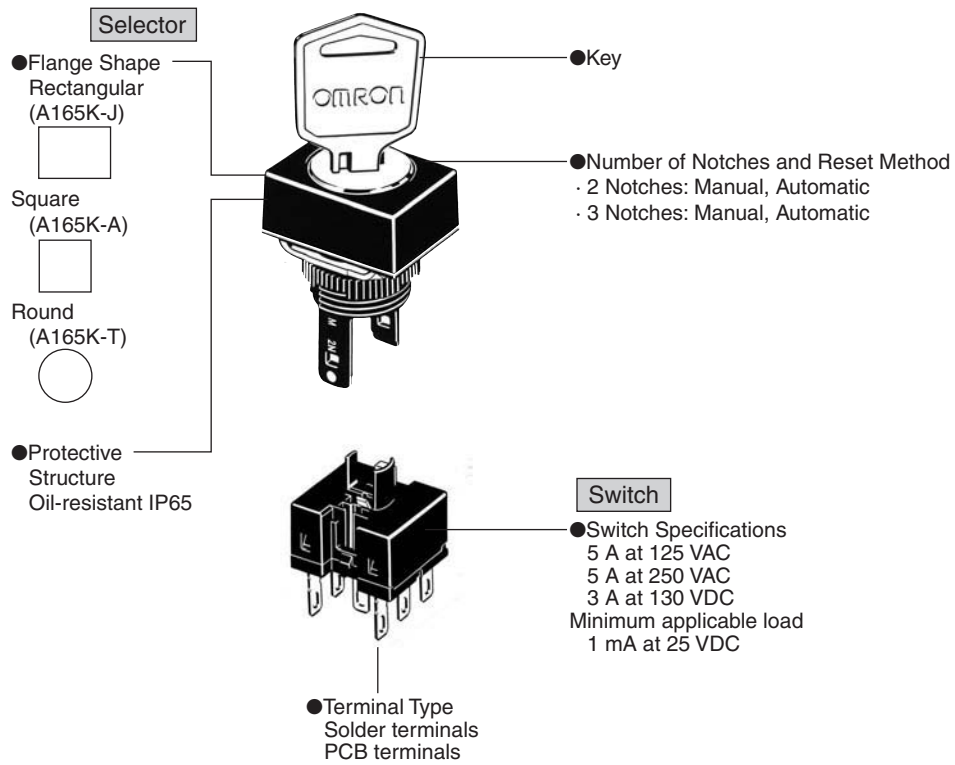

The flange can be rotated to easily change the operation angle of the knob.

For information on rotating the flange, refer to the A165S/W datasheet.

Example: Knob-type Selector Switch with Two Notches

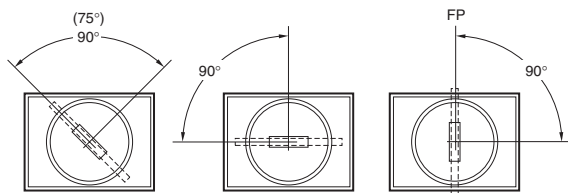

(Standard condition when shipped)

Note: The angle is 75° for self-resetting models.

Dimensions The Dimension shows 2-switch outputs.

Rectangular A165K-J Solder terminals (tab terminals #110)

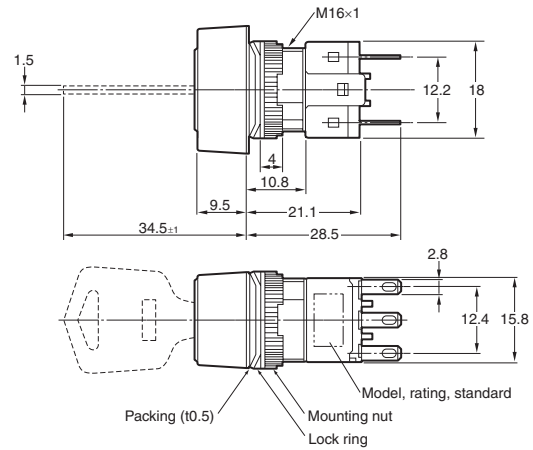
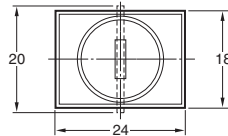

* Refer to the A165S/W for Panel cutouts.

Square A165K-A Solder terminals (tab terminals #110)

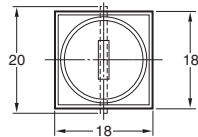
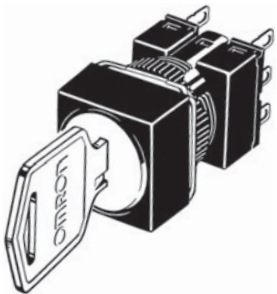

* Refer to the A165S/W for Panel cutouts.

Round A165K-T Solder terminals (tab terminals #110)

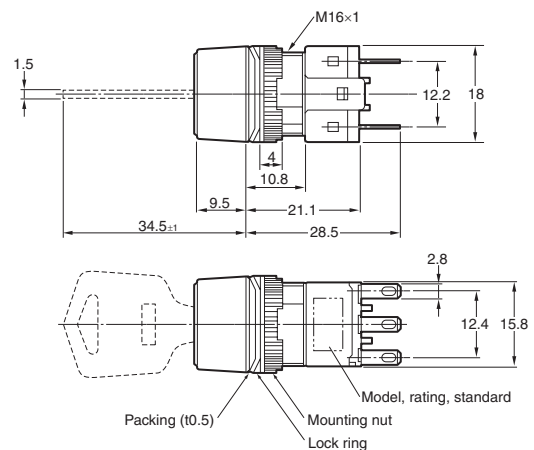
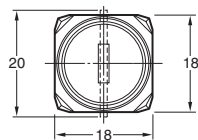

* Refer to the A165S/W for Panel cutouts.

Dimensions

• The Dimension shows 2-switch outputs. • The lamp terminal is also provided with non-lighted models. • A rectangular model is listed as an example. (Unit: mm)

Rectangular A165K□-2S

Screw-Less Clamp

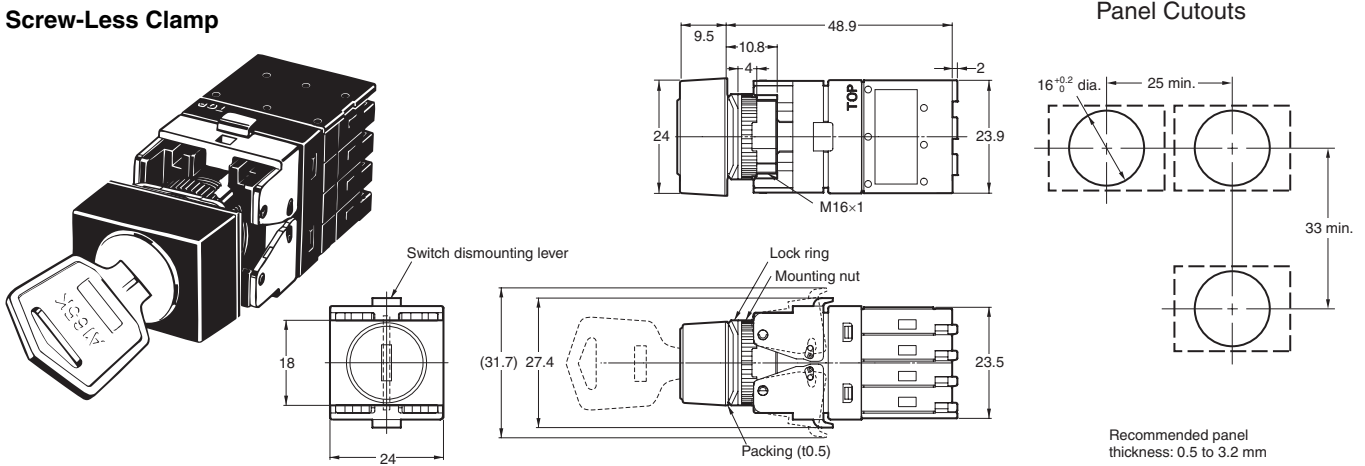

Terminal Arrangement

For information on the terminal arrangement, refer to the A165S/W datasheet.

Panel Mounting and Socket Unit Mounting and Removal

Refer to the A16 Pushbutton Switch datasheet.

Flange Rotation

Refer to the A165S/W datasheet.

Safety Precautions

Refer to *Safety Precautions for All Pushbutton Switches/Indicators*.

Precautions for Correct Use

Mounting

- Always make sure that the power is turned OFF before mounting, removing, or wiring the Switch, or performing maintenance.
- Do not tighten the mounting nut more than necessary using tools such as pointed-nose pliers. Doing so will damage the mounting nut.

The tightening torque is 0.29 to 0.49 N·m.

Wiring

- Solder terminals and quick-connect terminals (#110) are commonly used for terminals.
- Be sure to use electrical wires that are a size appropriate for the applied voltage and carry current (conductor size is 0.5 to 0.75 mm²). Perform soldering according to the conditions provided below. If the soldering is not properly performed, the lead wires will become detached, resulting in short-circuits.
 1. Hand soldering: 350°C, within 3 s
 2. Dip soldering: 350°C, within 3 s

Wait for one minute after soldering before exerting any external force on the solder.
- Use non-corrosive resin fluid as the flux.
- Make sure that the electric cord is wired so that it does not touch the Unit. If the electric cord touches the Unit, then electric wires with a heat resistance of 100°C min. must be used.
- After wiring the Switch, maintain an appropriate clearance and creepage distance.

Operating Environment

- The IP65 model is designed with a degree of protection so that it will not sustain damage if it is subjected to water from any direction to the front of the panel.

Using the Microload

- Insert a contact protection circuit, if necessary, to prevent the reduction of life expectancy due to extreme wear on the contacts caused by loads where inrush current occurs when the contact is opened and closed.
- The A16 allows both a standard load (125 V at 5A, 250 V at 3 A) and a microload. If a standard load is applied, however, the microload area cannot be used. If the microload area is used with a standard load, the contact surface will become rough, and the opening and closing of the contact for a microload may become unreliable.
- The minimum applicable load is the N-level reference value. This value indicates the malfunction reference level for the reliability level of 60% (λ 60) (conforming to JIS C5003). The equation, λ 60 = 0.5×10^{-6} /operations indicates that the estimated malfunction rate is less than 1/2,000,000 operations with a reliability level of 60%.

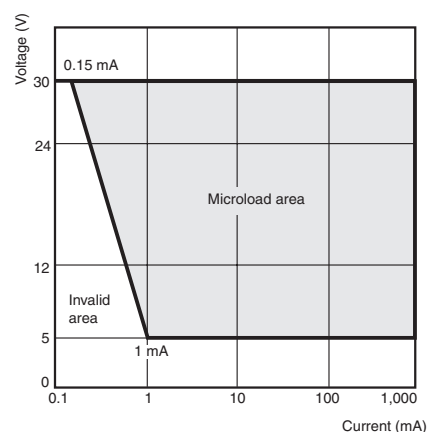

Others

- The oil-resistant IP65 uses NBR rubber and is resistant to general cutting oil and cooling oil. Some particular oils cannot be used with the oil-resistant IP65, however, so contact your OMRON representative for details.
- If the panel is to be finished with coating, etc., make sure that the panel meets the specified dimensions after the coating.
- Do not subject the Switch to extreme shock or vibration. Doing so will cause malfunctions and damage to the Switch. Do not let sharp objects come into contact with the Switches that are made of resin. Doing so will damage the Switches, causing scratches on the outside of the operating parts, and malfunction. When handling the Switches, do not throw or drop them.

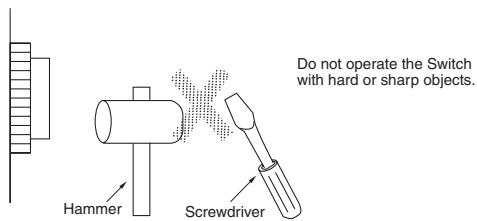
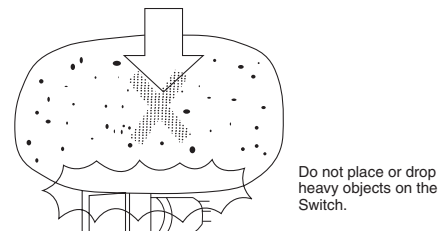
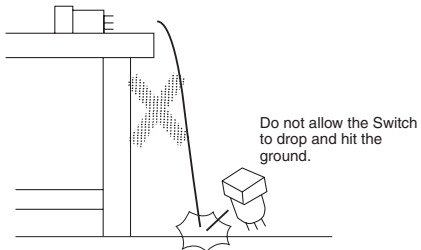

Terms and Conditions Agreement

Read and understand this catalog.

Please read and understand this catalog before purchasing the products. Please consult your OMRON representative if you have any questions or comments.

Warranties.

(a) Exclusive Warranty. Omron's exclusive warranty is that the Products will be free from defects in materials and workmanship for a period of twelve months from the date of sale by Omron (or such other period expressed in writing by Omron). Omron disclaims all other warranties, express or implied.

(b) Limitations. OMRON MAKES NO WARRANTY OR REPRESENTATION, EXPRESS OR IMPLIED, ABOUT NON-INFRINGEMENT, MERCHANTABILITY OR FITNESS FOR A PARTICULAR PURPOSE OF THE PRODUCTS. BUYER ACKNOWLEDGES THAT IT ALONE HAS DETERMINED THAT THE PRODUCTS WILL SUITABLY MEET THE REQUIREMENTS OF THEIR INTENDED USE.

Omron further disclaims all warranties and responsibility of any type for claims or expenses based on infringement by the Products or otherwise of any intellectual property right. (c) Buyer Remedy. Omron's sole obligation hereunder shall be, at Omron's election, to (i) replace (in the form originally shipped with Buyer responsible for labor charges for removal or replacement thereof) the non-complying Product, (ii) repair the non-complying Product, or (iii) repay or credit Buyer an amount equal to the purchase price of the non-complying Product; provided that in no event shall Omron be responsible for warranty, repair, indemnity or any other claims or expenses regarding the Products unless Omron's analysis confirms that the Products were properly handled, stored, installed and maintained and not subject to contamination, abuse, misuse or inappropriate modification. Return of any Products by Buyer must be approved in writing by Omron before shipment. Omron Companies shall not be liable for the suitability or unsuitability or the results from the use of Products in combination with any electrical or electronic components, circuits, system assemblies or any other materials or substances or environments. Any advice, recommendations or information given orally or in writing, are not to be construed as an amendment or addition to the above warranty.

See <http://www.omron.com/global/> or contact your Omron representative for published information.

Limitation on Liability; Etc.

OMRON COMPANIES SHALL NOT BE LIABLE FOR SPECIAL, INDIRECT, INCIDENTAL, OR CONSEQUENTIAL DAMAGES, LOSS OF PROFITS OR PRODUCTION OR COMMERCIAL LOSS IN ANY WAY CONNECTED WITH THE PRODUCTS, WHETHER SUCH CLAIM IS BASED IN CONTRACT, WARRANTY, NEGLIGENCE OR STRICT LIABILITY.

Further, in no event shall liability of Omron Companies exceed the individual price of the Product on which liability is asserted.

Suitability of Use.

Omron Companies shall not be responsible for conformity with any standards, codes or regulations which apply to the combination of the Product in the Buyer's application or use of the Product. At Buyer's request, Omron will provide applicable third party certification documents identifying ratings and limitations of use which apply to the Product. This information by itself is not sufficient for a complete determination of the suitability of the Product in combination with the end product, machine, system, or other application or use. Buyer shall be solely responsible for determining appropriateness of the particular Product with respect to Buyer's application, product or system. Buyer shall take application responsibility in all cases.

NEVER USE THE PRODUCT FOR AN APPLICATION INVOLVING SERIOUS RISK TO LIFE OR PROPERTY OR IN LARGE QUANTITIES WITHOUT ENSURING THAT THE SYSTEM AS A WHOLE HAS BEEN DESIGNED TO ADDRESS THE RISKS, AND THAT THE OMRON PRODUCT(S) IS PROPERLY RATED AND INSTALLED FOR THE INTENDED USE WITHIN THE OVERALL EQUIPMENT OR SYSTEM.

Programmable Products.

Omron Companies shall not be responsible for the user's programming of a programmable Product, or any consequence thereof.

Performance Data.

Data presented in Omron Company websites, catalogs and other materials is provided as a guide for the user in determining suitability and does not constitute a warranty. It may represent the result of Omron's test conditions, and the user must correlate it to actual application requirements. Actual performance is subject to the Omron's Warranty and Limitations of Liability.

Change in Specifications.

Product specifications and accessories may be changed at any time based on improvements and other reasons. It is our practice to change part numbers when published ratings or features are changed, or when significant construction changes are made. However, some specifications of the Product may be changed without any notice. When in doubt, special part numbers may be assigned to fix or establish key specifications for your application. Please consult with your Omron's representative at any time to confirm actual specifications of purchased Product.

Errors and Omissions.

Information presented by Omron Companies has been checked and is believed to be accurate; however, no responsibility is assumed for clerical, typographical or proofreading errors or omissions.

2015.9

In the interest of product improvement, specifications are subject to change without notice.

OMRON Corporation
Industrial Automation Company

<http://www.ia.omron.com/>

(c)Copyright OMRON Corporation 2015 All Right Reserved.