

CPDUR5V0R-HF

RoHS Device
Halogen Free

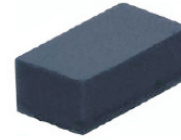

Features

- Bi-directional ESD protection.
- IEC61000-4-2 Level 4 ESD protection.
- Surface mount package.
- Operating voltage: 5V

Mechanical data

- Case: 0603/SOD-523F standard package, molded plastic.
- Terminals: Gold plated, solderable per MIL-STD-750,method 2026
- Mounting position: Any
- Weight: 0.003 grams(approx.).

Circuit Diagram

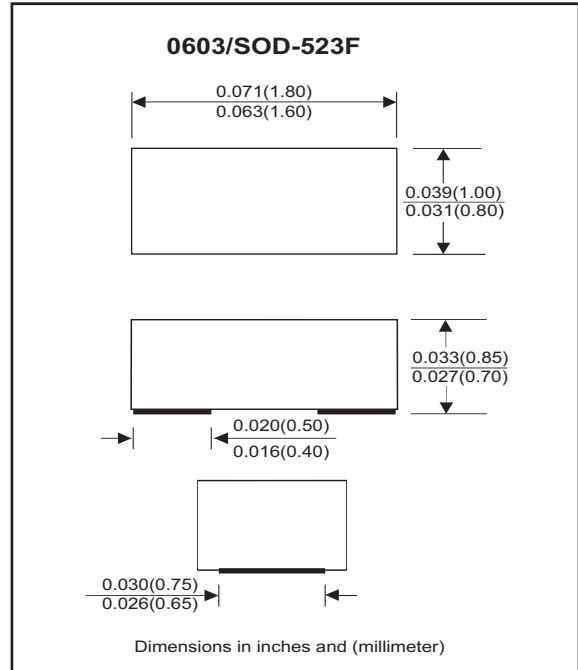

Maximum Rating And Electrical Characteristics (at TA=25°C unless otherwise noted)

Parameter	Conditions	Symbol	Min	Typ	Max	Unit
Reverse stand-Off voltage		V _{RWM}	-	-	5	V
Diode breakdown voltage	I _R = 1mA	V _{BD}	5.6	-	9.4	V
Reverse leakage current	V _R = 5V	I _L	-	5	90	nA
Junction capacitance	V _R = 0V, f = 1MHz	C _T	-	20	30	pF
ESD capability	IEC 61000-4-2(Air)	ESD	-	-	±30	kV
	IEC 61000-4-2(Contact)	ESD	-	-	±30	kV
Clamping Voltage	I _{PP} = 1 A, t _p =8/20us	V _c	-	-	8	V
	I _{PP} = 11 A, t _p =8/20us	V _c	-	-	12	V
Operation temperature		T _j	-40	-	+150	°C
Storage temperature		T _{STG}	-40	-	+150	°C

RATING AND CHARACTERISTIC CURVES (CPDUR5V0R-HF)

Fig. 1 - Reverse Characteristics

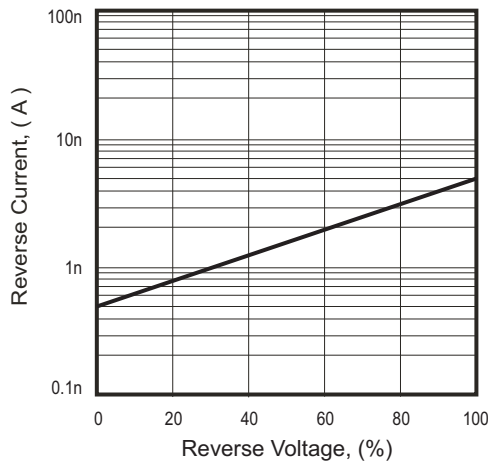

Fig. 2 - Capacitance Between Terminals Characteristics

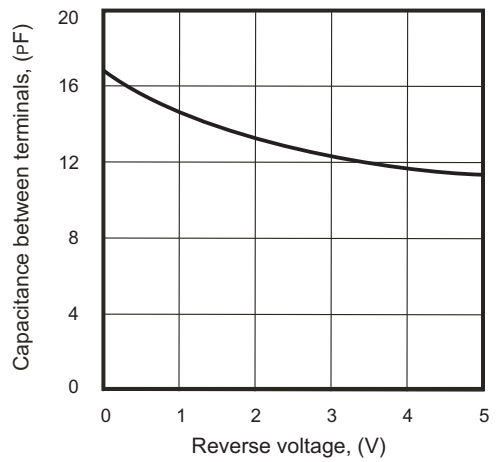

Fig.3 - Clamping Voltage Vs. Peak Pulse Current

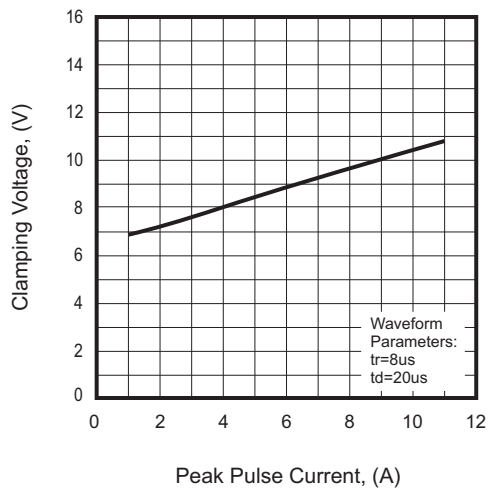
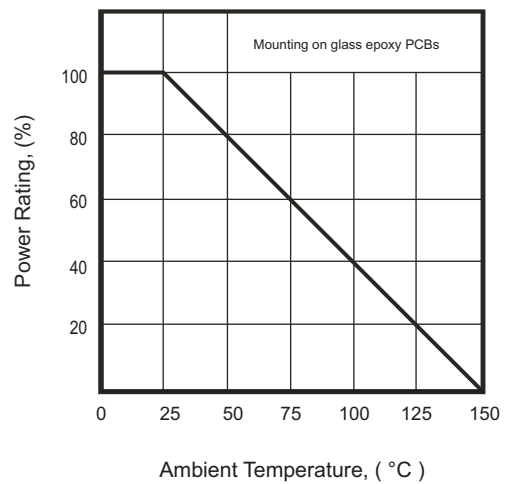
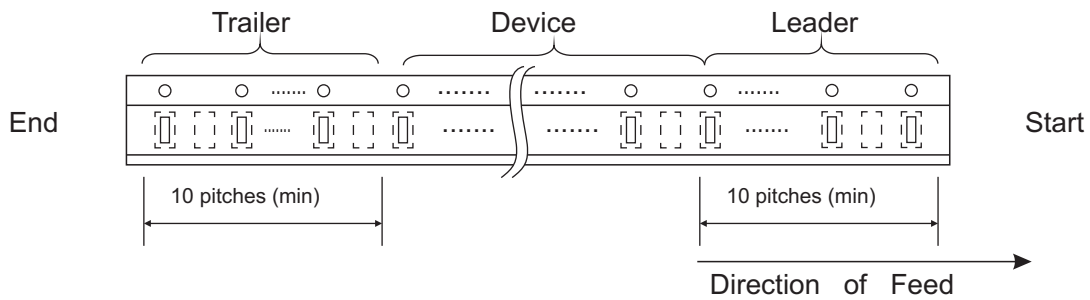
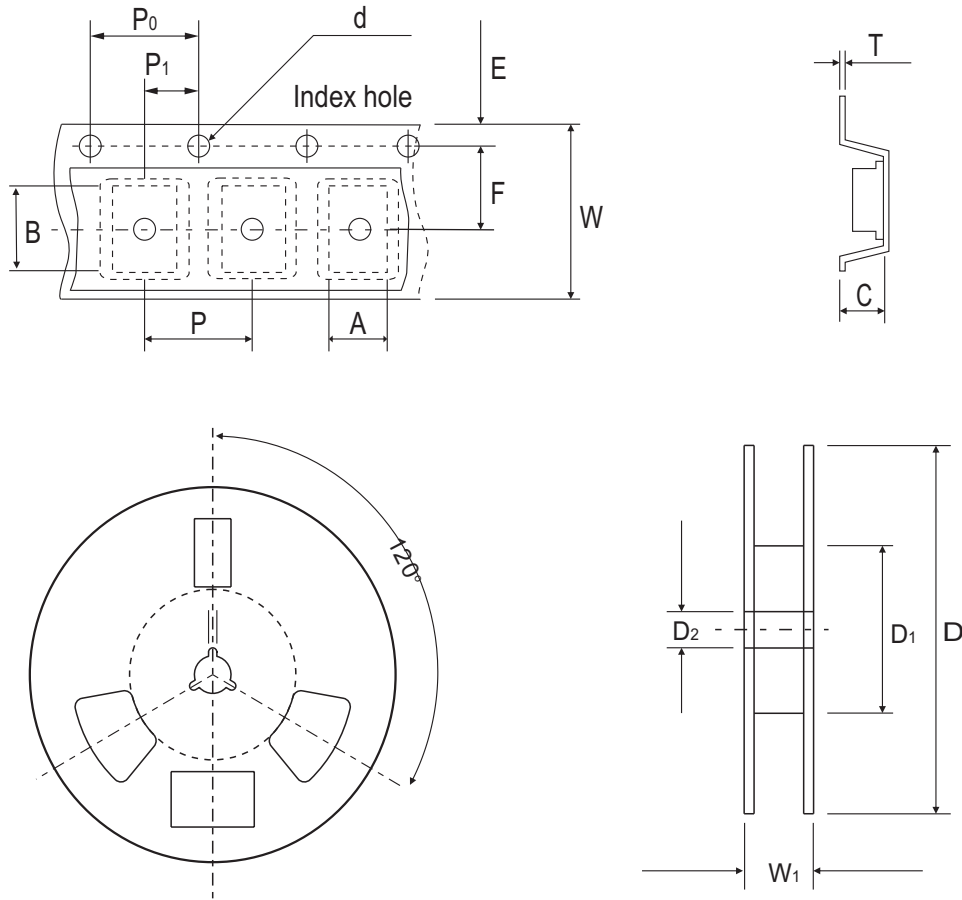

Fig. 4 - Power Rating Derating Curve



Reel Taping Specification



0603 (SOD-523)	SYMBOL	A	B	C	d	D	D ₁	D ₂
	(mm)	1.00 ± 0.10	1.85 ± 0.10	1.00 ± 0.10	1.55 ± 0.05	178 ± 1	60.0 MIN.	13.0 ± 0.20
	(inch)	0.039 ± 0.004	0.073 ± 0.004	0.039 ± 0.004	0.061 ± 0.002	7.008 ± 0.04	2.362 MIN.	0.512 ± 0.008

0603 (SOD-523)	SYMBOL	E	F	P	P ₀	P ₁	T	W	W ₁
	(mm)	1.75 ± 0.10	3.50 ± 0.05	4.00 ± 0.10	4.00 ± 0.10	2.00 ± 0.05	0.23 ± 0.05	8.00 ± 0.20	13.5 MAX.
	(inch)	0.069 ± 0.004	0.138 ± 0.002	0.157 ± 0.004	0.157 ± 0.004	0.079 ± 0.004	0.009 ± 0.002	0.315 ± 0.008	0.531 MAX.

Marking Code

Part Number	Marking Code
CPDUR5V0R-HF	E5R



Suggested PAD Layout

SIZE	0603/SOD-523F	
	(mm)	(inch)
A	1.25	0.049
B	0.60	0.024
C	1.00	0.039
D	1.85	0.073
E	0.65	0.026

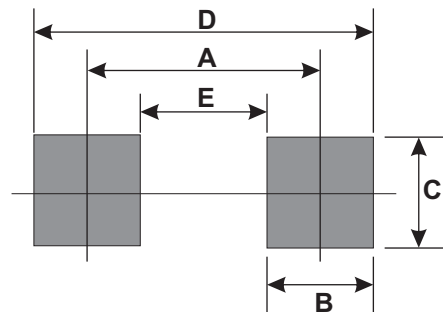

Standard Packaging

Case Type	REEL PACK	
	REEL (pcs)	Reel Size (inch)
0603/SOD-523F	4,000	7