

User Manual

SOM-4463 B2

ADVANTECH

Enabling an Intelligent Planet

Copyright

The documentation and software included with this product are copyrighted 2014 by Advantech Co., Ltd, all rights reserved. Advantech Co., Ltd. reserves the right to improve the products described in this manual at any time without notice.

No part of this manual may be reproduced, copied, translated or transmitted in any form or by any means without the prior written permission of Advantech Co., Ltd. The information provided in this manual is intended to be accurate and reliable. However, Advantech Co., Ltd. assumes no responsibility for its use, nor for any infringements of the rights of third parties, which may result from its use.

Acknowledgements

AMI is a trademark of American Megatrends Inc.

VIA is a trademark of VIA Technologies, Inc.

IBM, PC/AT, PS/2, and VGA are trademarks of International Business Machines Corporation.

Intel® and Pentium® are trademarks of Intel Corporation.

Microsoft Windows® is a registered trademark of Microsoft Corp.

RTL is a trademark of Realtek Semi-Conductor Co., Ltd.

ESS is a trademark of ESS Technology, Inc.

UMC is a trademark of United Microelectronics Corporation.

SMI is a trademark of Silicon Motion, Inc.

Creative is a trademark of Creative Technology LTD.

CHRONTEL is a trademark of Chrontel Inc.

All other product names or trademarks are properties of their respective owners.

Product Warranty (2 years)

Advantech warrants the original purchaser that each of its products will be free from defects in materials and workmanship for two years from the date of purchase.

This warranty does not apply to any products that have been repaired or altered by persons other than repair personnel authorized by Advantech, or products that have been subject to misuse, abuse, accident, or improper installation. Advantech assumes no liability under the terms of this warranty as a consequence of such events.

Because of Advantech's high quality-control standards and rigorous testing, most of our customers never need to use our repair service. If an Advantech product is defective, it will be repaired or replaced at no charge during the warranty period. For out-of-warranty repairs, you will be billed according to the cost of replacement materials, service time and freight. Please consult your dealer for more details.

If you think you have a defective product, follow these steps:

1. Collect all the information about the problem encountered. (For example, CPU speed, Advantech products used, other hardware and software used, etc.) Note anything abnormal and list any onscreen messages displayed when the problem occurs.
2. Call your dealer and describe the problem. Please have your manual, product, and any relevant information readily available.
3. If your product is diagnosed as defective, obtain an RMA (return merchandise authorization) number from your dealer. This enables us to process your return more quickly.
4. Carefully pack the defective product, a completed Repair and Replacement Order Card, and proof of purchase date (such as a photocopy of your sales receipt) in a shippable container. Products returned without a proof of purchase date are not eligible for our warranty service.
5. Write the RMA number clearly on the outside of the package and ship the product prepaid to your dealer.

Technical Support and Assistance

1. Visit the Advantech website at www.advantech.com/support for the latest information about this product.
2. Contact your distributor, sales representative, or Advantech's customer service center for technical support if you require additional assistance. Please have the following information ready before calling:
 - Product name and serial number
 - Description of the peripheral attachments
 - Description of the software (operating system, version, application software, etc.)
 - Comprehensive description of the problem
 - The exact wording of any error messages

Safety Instructions

1. Read these safety instructions carefully.
2. Retain this user manual for future reference.
3. Disconnect this equipment from all AC outlets before cleaning. Use only a damp cloth for cleaning. Do not apply liquid or spray detergents.
4. For plugged-in equipment, the power outlet socket must be located near the equipment and easily accessible.
5. Protect this equipment from humidity.
6. Place this equipment on a reliable surface during installation. Dropping or letting the equipment fall may cause damage.
7. The openings of the enclosure are designated for air convection to prevent the equipment from overheating. **DO NOT COVER THESE OPENINGS.**
8. Ensure the power source voltage is correct before connecting the equipment to a power outlet.
9. Position the power cord away from high-traffic areas. Do not place anything over the power cord.
10. All cautions and warnings on the equipment should be noted.
11. If unused for a lengthy duration, disconnect the equipment from the power source to avoid damage from transient overvoltage.
12. Never pour liquid into an opening. This may cause fire or electrical shock.
13. Never open the equipment. For safety reasons, the equipment should only be opened by qualified service personnel.
14. If any of the following occurs, have the equipment checked by authorized service personnel:
 - The power cord or plug is damaged.
 - Liquid has penetrated into the equipment.
 - The equipment has been exposed to moisture.
 - The equipment is malfunctioning, or does not operate according to the user manual.
 - The equipment has been dropped and damaged.
 - The equipment shows obvious signs of breakage.

Safety Precautions - Static Electricity

Follow the simple precautions provided below to protect yourself from harm and the products from damage.

- To avoid electrical shock, always disconnect the power from the PC chassis before manual handling. Do not touch components on the CPU card or other cards when the PC is powered on.
- Disconnect the power before making configuration changes. A sudden rush of power after connecting a jumper or installing a card can damage sensitive electronic components.

Packing List

Before beginning card installation, please ensure that the following items have been shipped:

- SOM-4463 B2 module with heat spreader
- User manual and drivers

Contents

Chapter 1	General Information	1
1.1	Introduction	2
1.2	Specifications	2
1.2.1	Standard System-On-Module Functions	2
1.2.2	VGA/Flat-Panel Display Interface	2
1.2.3	Audio Function	2
1.2.4	LAN LED Function	3
	Table 1.1: LAN LED Signaling and Behavior Default Settings	3
1.2.5	Mechanical and Environmental Specifications.....	3
Chapter 2	Mechanical Information	5
2.1	Board Connectors	6
	Figure 2.1 SOM-4463 B2 Connector Locations	6
2.2	Board Mechanical Drawings	6
2.2.1	Front Side	6
	Figure 2.2 SOM-4463 B2 Front Side	6
2.2.2	Rear Side	7
	Figure 2.3 SOM-4463 B2 Rear Side	7
Chapter 3	BIOS Setup Information	9
3.1	Introduction	10
	Figure 3.1 Setup Program Initial Screen.....	10
3.2	Entering Setup	11
3.2.1	Main Setup.....	11
	Figure 3.2 Main Setup Screen	11
3.2.2	Advanced BIOS Features Setup.....	12
	Figure 3.3 Advanced BIOS Features Setup Screen	12
	Figure 3.4 CPU Configuration Settings.....	12
	Figure 3.5 IDE Configuration	13
	Figure 3.6 Floppy Configuration	14
	Figure 3.7 Super I/O Configuration	15
	Figure 3.8 Hardware Health Configuration	16
	Figure 3.9 ACPI Settings	16
	Figure 3.10 General ACPI Configuration	17
	Figure 3.11 Advanced ACPI Configuration	17
	Figure 3.12 Chipset ACPI Configuration	18
	Figure 3.13 AHCI Configuration	19
	Figure 3.14 APM Configuration	19
	Figure 3.15 Event Log Configuration	20
	Figure 3.16 MPS Configuration	21
	Figure 3.17 Smbios Configuration	21
	Figure 3.18 USB Configuration	22
	Figure 3.19 USB Mass Storage Device Configuration.....	23
3.3	Advanced PCI/PnP Settings	24
	Figure 3.20 PCI/PNP Setup Screen	24
3.4	Boot Settings.....	25
	Figure 3.21 Boot Setup Utility	25
3.4.1	Boot Settings Configuration	25
	Figure 3.22 Boot Settings Configuration	25
3.5	Security Setup.....	26

	Figure 3.23 Password Configuration	26
3.6	Advanced Chipset Settings	27
	Figure 3.24 Advanced Chipset Settings	27
3.6.1	North Bridge Chipset Configuration	27
	Figure 3.25 North Bridge Configuration	27
	Figure 3.26 Video Function Configuration	28
3.6.2	South Bridge Chipset Configuration	29
	Figure 3.27 South Bridge Configuration	29
3.7	Exit Options	30
	Figure 3.28 Exit Options	30
Chapter 4	Driver Installation	33
4.1	Driver Introduction	34
4.2	Driver Installation	34
Appendix A	Watchdog Timer	35
A.1	Programming the Watchdog Timer	36
Appendix B	System Assignments	39
B.1	System I/O Ports	40
	Table B.1: System I/O Ports	40
B.2	DMA Channel Assignments	41
	Table B.2: DMA Channel Assignments	41
B.3	Interrupt Assignments	42
	Table B.3: Interrupt Assignments	42
B.4	System Memory Map	43
	Table B.4: System Memory Map	43

Chapter 1

General Information

This chapter provides general information about the SOM-4463 B2 CPU System on Module.

- Introduction
- Specifications

1.1 Introduction

SOM-4463 B2 is an embedded CPU module that is fully compliant with the SOM-ETX form factor standard. This new CPU module supports Intel N455/D525 +ICH8M chipsets, which support PCI and ISA interfaces. In a basic form factor of 95 x 114 mm, SOM-4463 B2 provides a scalable, cost-effective, and easy-to-integrate solution that utilizes a plug-in CPU module on an application-specific customer solution board. The SOM-4463 B2 module with advanced I/O capacity incorporates PCI, ISA, IDE, USB 2.0, SATA, and LVDS interfaces. SOM-4463 B2 offers design partners greater flexibility for applications that require cost-effective solutions while maintaining a compact form factor.

The SOM-4463 B2 module is equipped with a N455/D525 CPU, DDR3 memory, as well as D525, which extends the memory capacity to 4GB. SOM-4463 B2 is the most complete of all current ETX modules. Featuring two IDE interfaces and 24-bit LVDS support, this module is the ideal system for both old and new applications.

1.2 Specifications

1.2.1 Standard System-On-Module Functions

- **CPU:** Intel® Atom™ N455 single-core processor
Intel® Atom™ D525 dual-core processor
- **BIOS:** AMI 16-Mbit Flash BIOS
- **Chipset:** Intel® N455/D525 +ICH8M
- **System memory:** DDR3 667 MHz up to 2GB (N455)
DDR3 800 MHz up to 4GB (D525)
- **Enhanced IDE interface:** Two EIDE channels that support two devices. BIOS auto-detect up to UDMA -100
- **Watchdog timer:** 256 potential timer intervals, ranging from 1 to 255 seconds or minutes, according to the software setup; features jumperless selection and system reset signal generation.
- **USB interface:** Supports 4 USB 2.0 ports
- **Expansion interface:** Supports PCI and ISA bus interfaces

1.2.2 VGA/Flat-Panel Display Interface

- **Chipset:** Intel® N455/D525
- **Memory size:** DVMT 3.0 supports up to 128 MB
- **Display mode:**
CRT Mode: Up to 1400 x 1050 (N455)
Up to 2048 x 1536 (D525)
LVDS Mode: Supports 18/24-bit LVDS

1.2.3 Audio Function

- **Audio interface:** Realtek ALC892 codec

1.2.4 LAN LED Function

Because of the variations in LAN chips, the behavior settings for the SOM-4463 B2 LAN LED have been changed, as shown in the table below.

Table 1.1: LAN LED Signaling and Behavior Default Settings

ETX-X4 Conn. Pin-out	SOM-4463 B1 LED Indicator	SOM-4463 B2 LED Indicator
D10 (LILED#) LED behavior	LINK (10/100) On indicates Link; off indicates non-Link	LINK (100) On indicates Link; off indicates non-Link/Link(10)
D12 (ACTLED#) LED behavior	ACT (10/100) Flashing indicates activation	ACT (10/100) Flashing indicates activation
D14 (SPEEDLED#) LED behavior	LINK (10/100) On denotes10 and 100	LINK (100) On denotes100 Off denotes10

1.2.5 Mechanical and Environmental Specifications

- **Dimensions:** ETX form factor, 114 x 95 mm (4.5 x 3.74")
- **Power supply voltage:** +5 V power only
(+5VSB is optional for ACPI and ATX power)
- **Power requirements:**
Max: +5 V @ 2.73 A (D525 w/4GB DDR3 memory)
- **Operating temperature:** 0 ~ 60 °C (32 ~ 140 °F)
- **Operating humidity:** 0 ~ 90% relative humidity, non-condensing
- **Weight:** 0.103 kg (total package weight)

Chapter 2

Mechanical Information

This chapter provides connector information and mechanical drawings.

- Connector Information
- Mechanical Drawings

2.1 Board Connectors

Two connectors are located at the rear side of SOM-4463 B2 to enable connection to a carrier board.

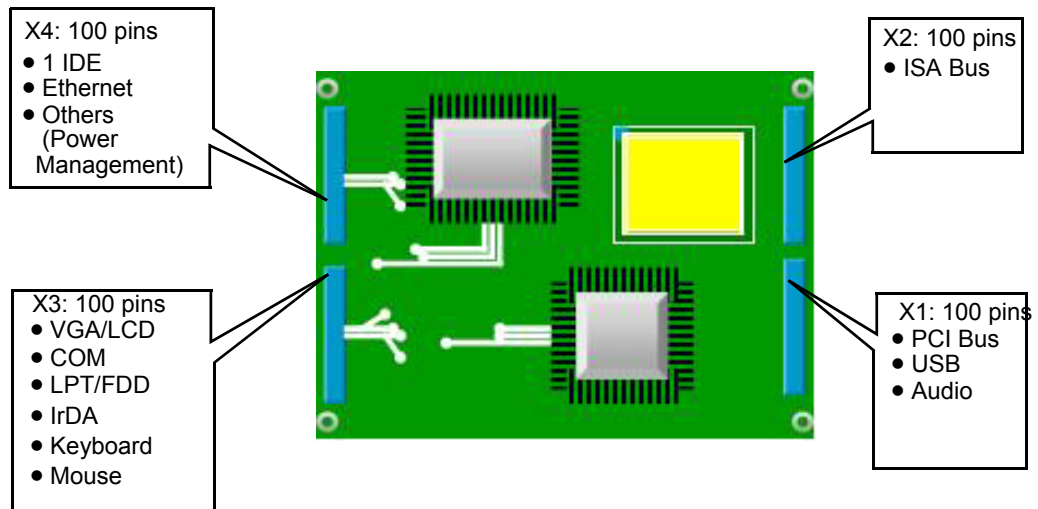

Figure 2.1 SOM-4463 B2 Connector Locations

■ Pin Assignments for X1/2/3/4 Connectors

For information about the pin assignments for X1/2/3/4 connectors, please refer to the SOM-ETX Design and Specification guide available for download at: http://www.advantech.com/COM_Design_Support_Services/documentdownload.aspx

2.2 Board Mechanical Drawings

2.2.1 Front Side

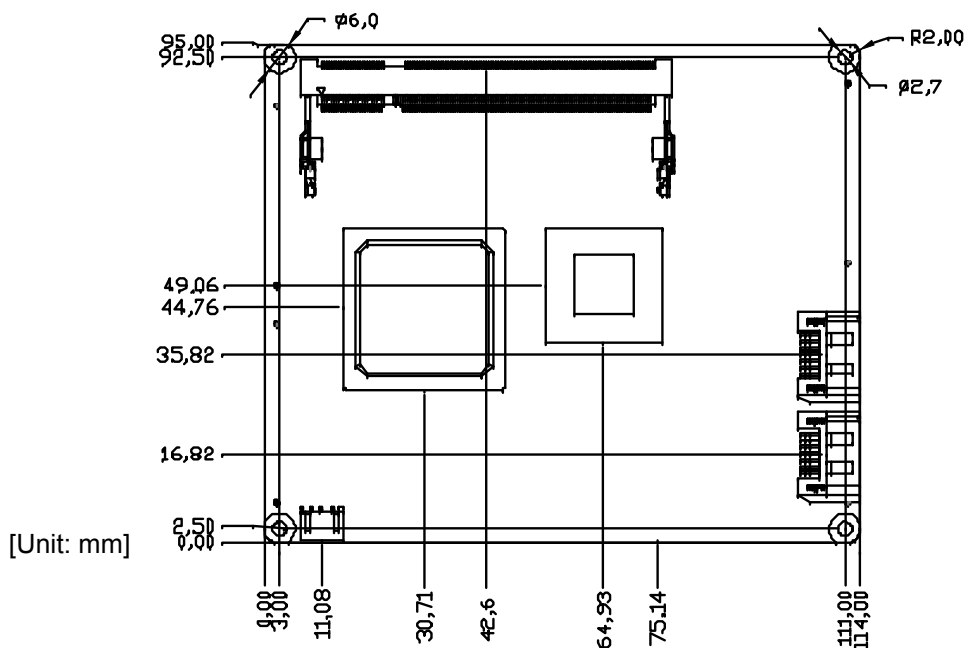

Figure 2.2 SOM-4463 B2 Front Side

2.2.2 Rear Side

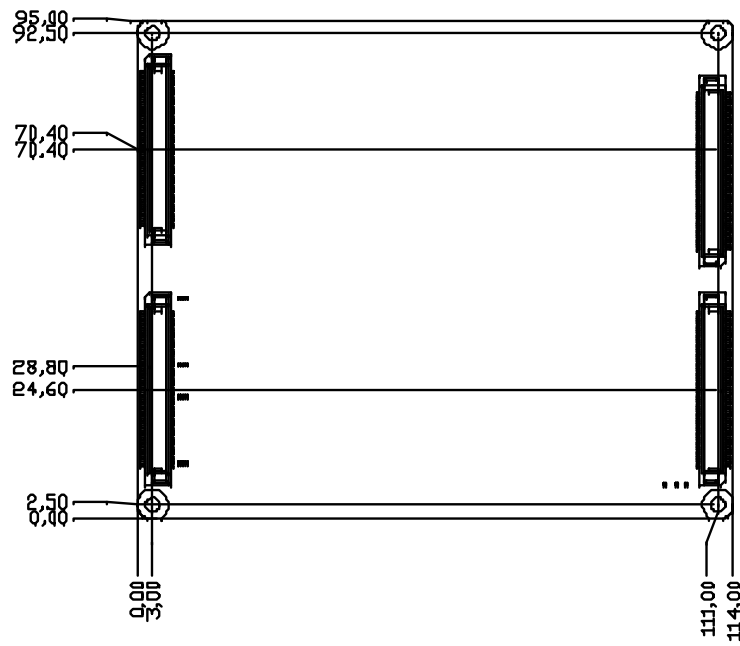

Figure 2.3 SOM-4463 B2 Rear Side

Chapter 3

BIOS Setup Information

This chapter details the basic BIOS settings.

- Main Setup
- Advanced Setup
- PCIPnP Setup
- Boot Setup
- Security Setup
- Chipset Setup

3.1 Introduction

AMIBIOS has been integrated into numerous motherboards for over a decade. With the AMIBIOS Setup program, users can modify the BIOS settings and control various system features. This chapter describes the basic navigation of the SOM-4463 B2 BIOS setup screens.

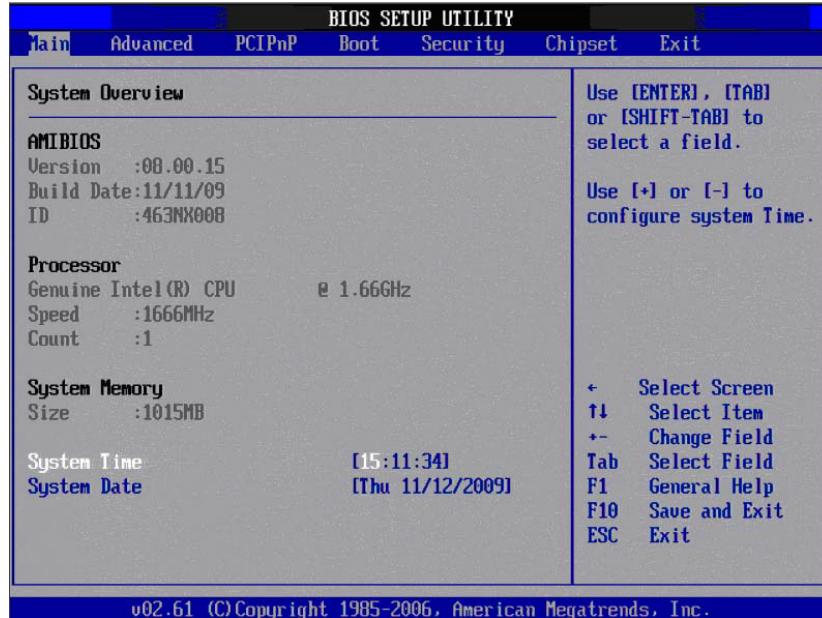

Figure 3.1 Setup Program Initial Screen

AMI's BIOS ROM features a built-in setup program that allows users to modify the basic system configuration. This information is stored in a CMOS backup battery, which retains the setup information even when the power is turned off.

3.2 Entering Setup

The BIOS is activated immediately after the computer is powered on. The BIOS reads the system information contained in the CMOS and initiates the system check and configuration process. Next, the BIOS identifies and launches an operating system located on one of the disks before turning over control to that operating system. When the BIOS is in control, the setup program can be activated using either of the following methods:

1. Press immediately after switching the system on.
2. Press when the following message appears at the bottom of the screen during the power-on self-test (POST).

If the message disappears before you can respond, restart the system and try again. The system can be restarted by turning the power off then on again, pressing the Reset button on the system case, or simultaneously pressing <Ctrl>, <Alt>, and <Delete>.

3.2.1 Main Setup

When first entering the BIOS setup utility, users will land on the Main setup screen. Users can always return to the Main setup screen by selecting the Main tab. This page features two setup options, which are explained in this section. The main BIOS setup screen is shown below.

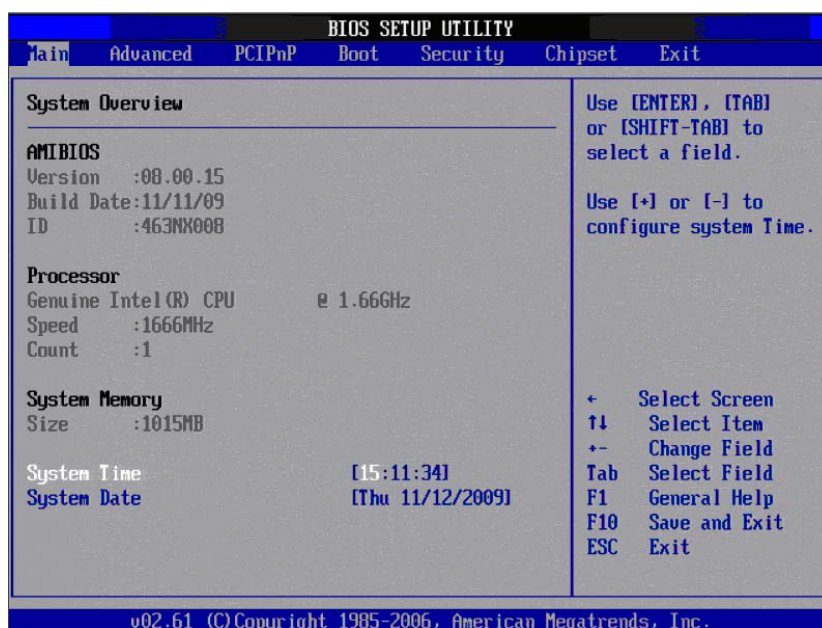

Figure 3.2 Main Setup Screen

The Main BIOS setup screen features two main frames. The left frame displays all configurable options. The grayed-out options cannot be configured, whereas the blue options can be. The right frame displays the key legend.

The area above the key legend is reserved for text messages. When an option is selected in the left frame, the text display color changes white. This is typically accompanied by a relevant text message.

■ System Time / System Date

Use this option to change the system time and date. Highlight the System Time or System Date options using the <Arrow> keys. Enter new values using the keyboard. Press the <Tab> or <Arrow> keys to move between fields. The date must be entered in MM/DD/YY format, and the time must be entered in HH:MM:SS format.

3.2.2 Advanced BIOS Features Setup

Select the Advanced tab from the SOM-4463 B2 setup screen to enter the Advanced BIOS setup screen. Select any item in the left frame of the screen, for example, “CPU Configuration”, to open the submenu for that item. Users can select an Advanced BIOS setup option by highlighting it using the <Arrow> keys. All Advanced BIOS Setup options are described in this section. The images presented below show the Advanced BIOS Setup screen. The submenus for each item are described in the following pages.

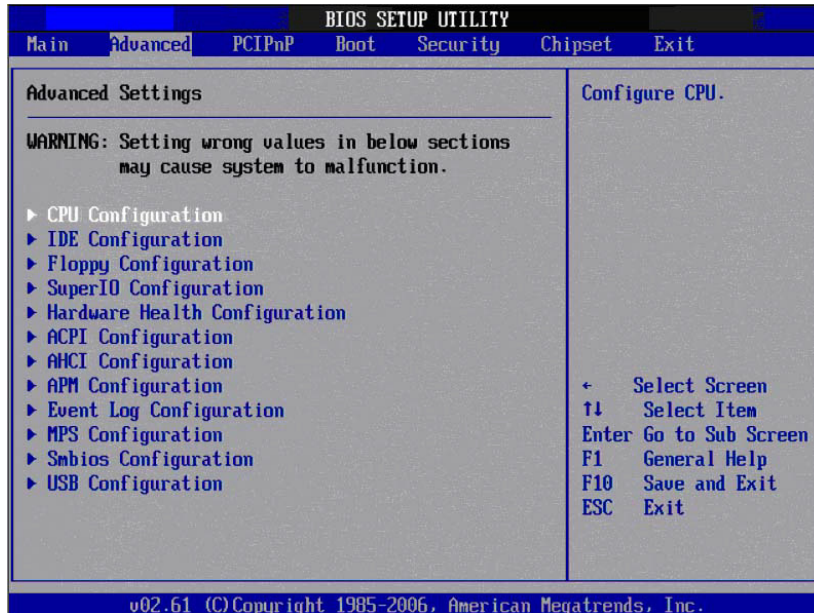

Figure 3.3 Advanced BIOS Features Setup Screen

3.2.2.1 CPU Configuration

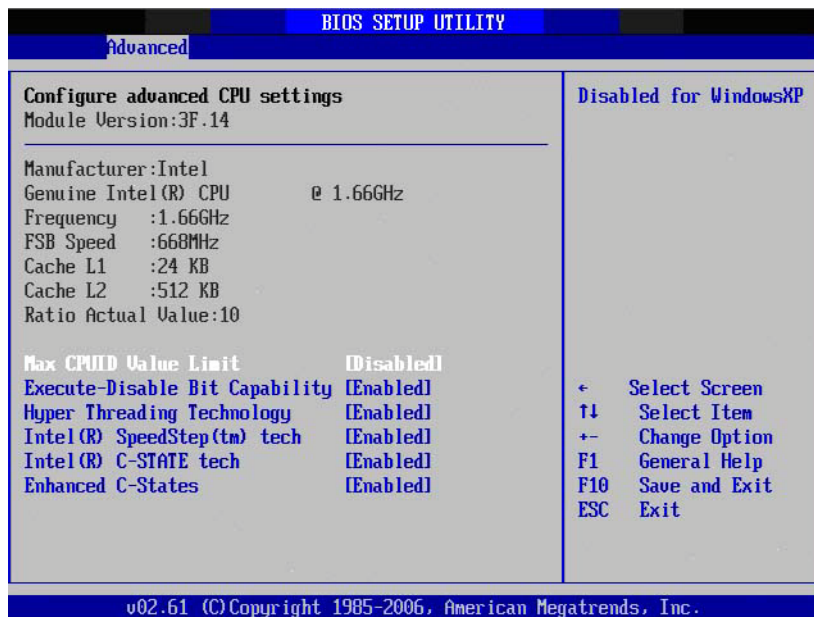

Figure 3.4 CPU Configuration Settings

■ Max CPUID Value Limit

This item allows users to limit the maximum CPUID value.

- **Execute-Disable Bit Capability**
This item allows users to enable or disable the No-Execution page protection technology.
- **Hyper Threading Technology**
This item allows users to enable or disable Intel® Hyper Threading technology.
- **Intel® SpeedStep™ Technology**
When this item is disable, the CPU runs at the default speed, if enabled, the CPU speed is controlled by the operating system.
- **Intel® C-STATE Technology**
This item allows the CPU to save additional power when in idle mode.
- **Enhanced C-States**
This item allows users to enable or disable Intel® C-STATE technology.

3.2.2.2 IDE Configuration

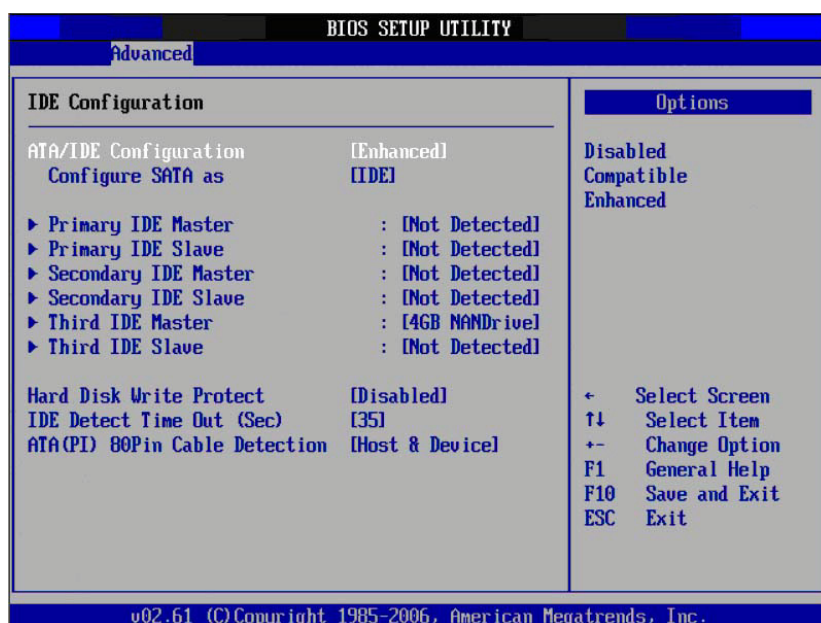

Figure 3.5 IDE Configuration

- **ATA / IDE Configuration**
Users can set this item as either “Disabled”, “Compatible”, or “Enhanced”.
- **Legacy IDE Channels**
When set as Enhanced, users can select either the IDE or AHCI modes. When set as Compatible, users can select “SATA only”, “SATA Primary, PATA Secondary” or “PATA only”.
- **Primary / Secondary / Third IDE Master / Slave**
The BIOS auto detects the presence of IDE device and displays the device status.
 - **Type:** Select the type of SATA driver: Not Installed, Auto, CD/DVD, or ARMD
 - **LBA / Large Mode:** Enable or disable LBA mode.
 - **Block (Multi-Sector Transfer):** Enable or disable multi-sector data transfers.
 - **PIO Mode:** Enable or disable PIO mode.
 - **DMA Mode:** Enable or disable DMA mode.
 - **S.M.A.R.T.:** Select Self-Monitoring, Analysis, and Reporting Technology.
 - **32-Bit Data Transfers:** Enable or disable 32-bit data transfers.

- **Hard Disk Write Protect**
Enable or disable device write protection. This is only effective if the device is accessed through the BIOS.
- **IDE Detect Time Out (Sec)**
This item allows users to set the time out value for ATA/ATAPI device detection.
- **ATA(PI) 80 Pin Cable Detection**
This item allows users to select the method for detecting the IDE 80 pin cable.

3.2.2.3 Floppy Configuration

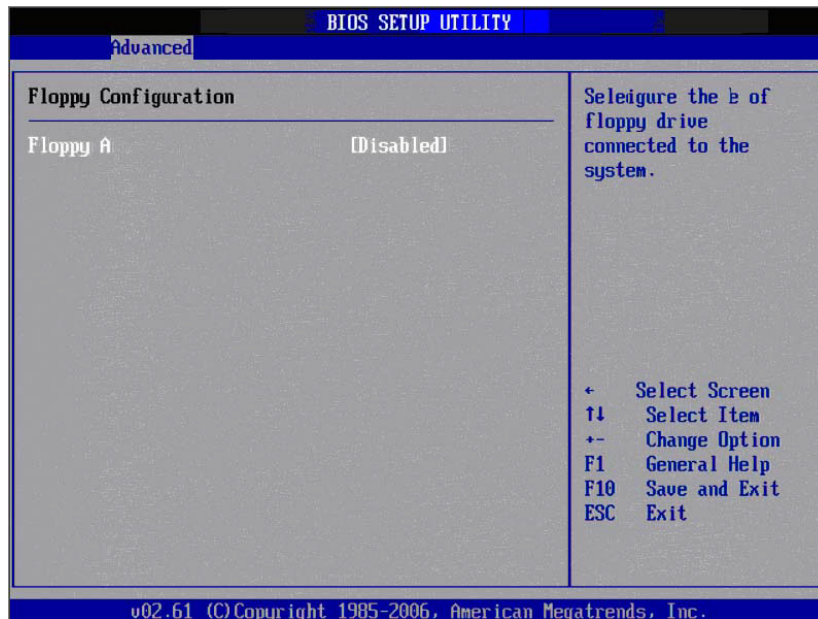

Figure 3.6 Floppy Configuration

- **Floppy A**
Select the type of floppy drive connected to the system, if any. Users are advised to disable the floppy drive when installing Windows Vista if no floppy drive is connected.

3.2.2.4 Super I/O Configuration

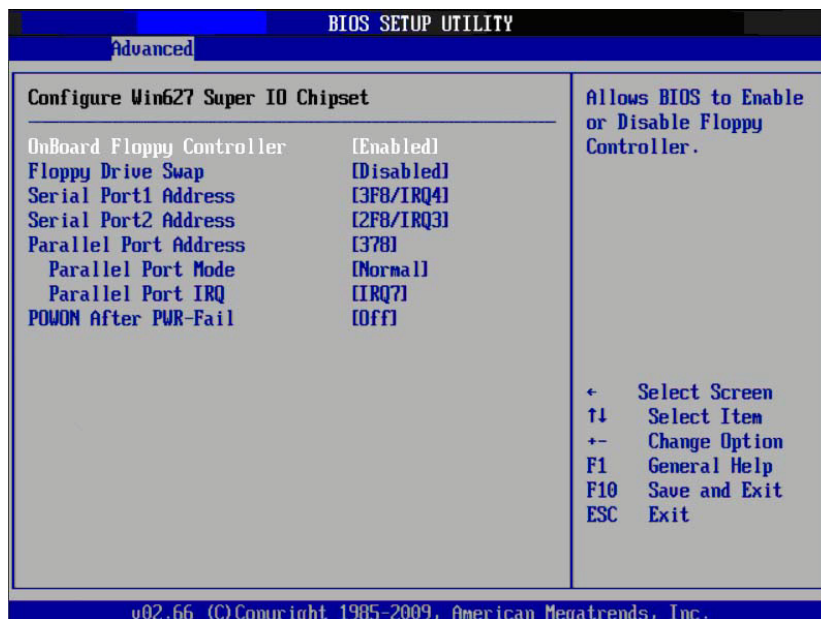

Figure 3.7 Super I/O Configuration

- **Onboard Floppy Controller**
This item allows users to enable or disable the onboard floppy controller.
- **Floppy Drive Swap**
This item allows users to enable or disable the floppy drive swap function.
- **Serial Port 1 / Port 2 Address**
These items allow users to select the base addresses and IRQs for Serial Ports 1 and 2.
- **Parallel Port Address**
This item allows users to select the base address of the parallel port.
- **Parallel Port Mode**
This item allows users to select the mode for the parallel port.
- **Parallel Port IRQ**
This item allows users to select the IRQ for the parallel port.
- **POWON After PWR-Fail**
For this item, users can select either “Off”, “On, or “Former Status”.

3.2.2.5 Hardware Health Configuration



Figure 3.8 Hardware Health Configuration

- **ACPI Critical Shutdown Temp**
This item allows users to set the CPU system shutdown temperature for the ACPI OS.
- **System / CPU Temperature**
+5 V / +5 VSB / VBAT

3.2.2.6 ACPI Settings

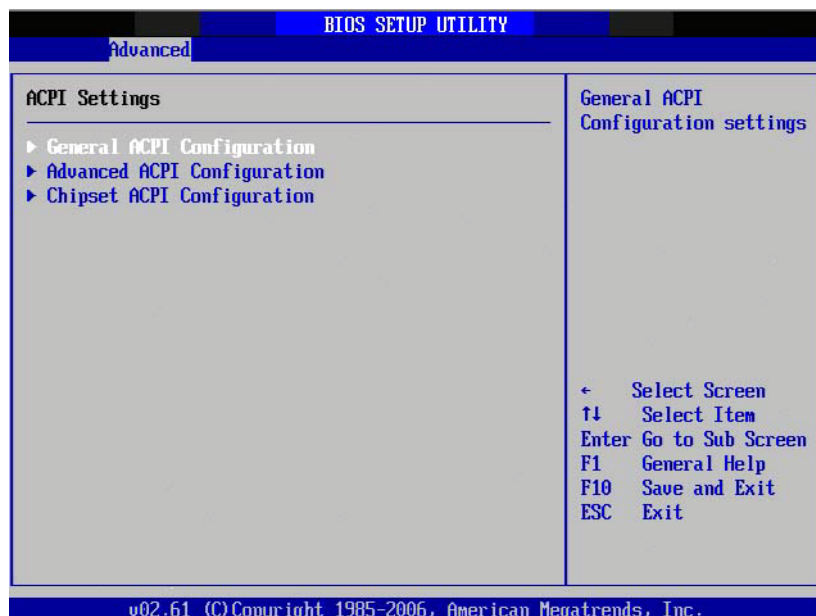

Figure 3.9 ACPI Settings

3.2.2.7 General ACPI Configuration

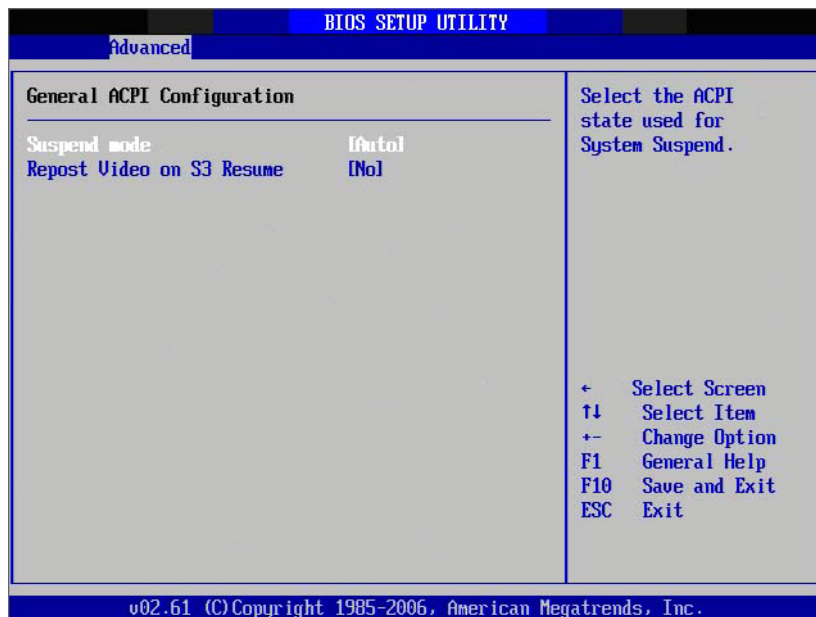

Figure 3.10 General ACPI Configuration

- **Suspend Mode**
This item allows users to select the ACPI state used for system suspend.
- **Report Video on S3 Resume**
This item allows users to invoke VGA BIOS POST on S3 / STR resume.

3.2.2.8 Advanced ACPI Configuration

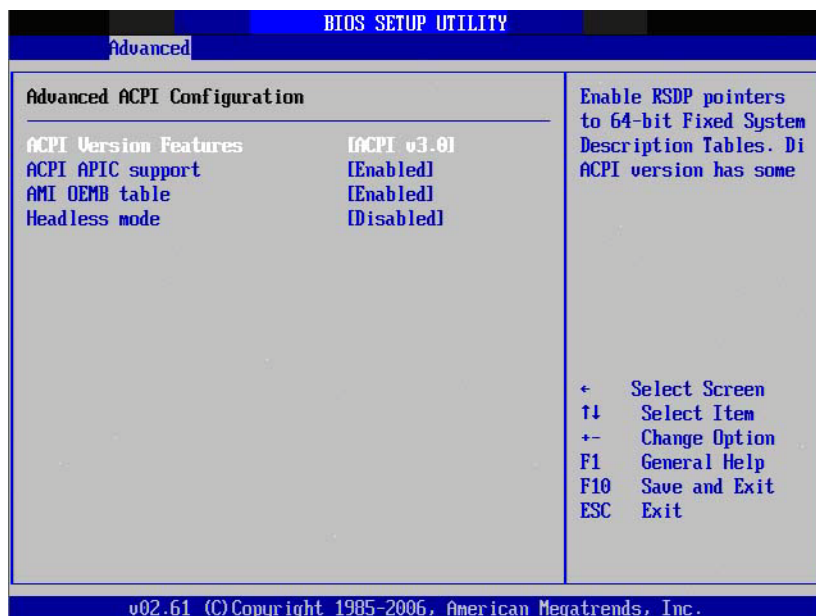

Figure 3.11 Advanced ACPI Configuration

- **ACPI Version Features**
This item allows users to enable RSDP pointers for 64-bit fixed system description tables.

- **ACPI APIC Support**
This item allows users to include APIC table pointers in RSDT pointer lists.
- **AMI OEMB Table**
This item allows users to include OEMB table pointers in R(x)SDT pointer lists.
- **Headless Mode**
This item allows users to enable or disable Headless mode through ACPI.

3.2.2.9 Chipset ACPI Configuration

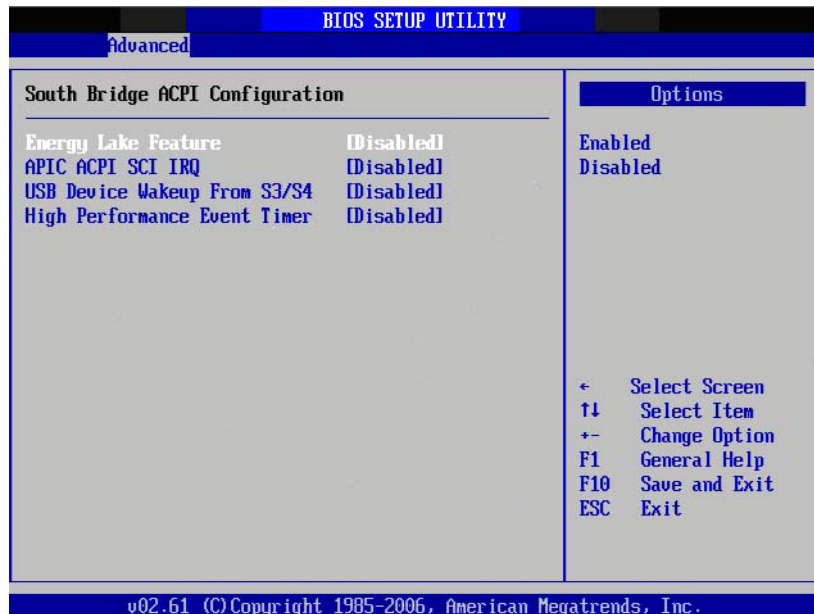

Figure 3.12 Chipset ACPI Configuration

- **Energy Lake Feature**
This item allows users to configure Intel's Energy Lake power management technology.
- **APIC ACPI SCI IRQ**
This item allows users to enable or disable APIC ACPI SCI IRQ.
- **USB Device Wakeup From S3/S4**
This item allows users to enable or disable USB device wakeup from S3/S4.
- **High-Performance Event Timer**
This item allows users to enable or disable a high-performance event timer.

3.2.2.10 AHCI Configuration

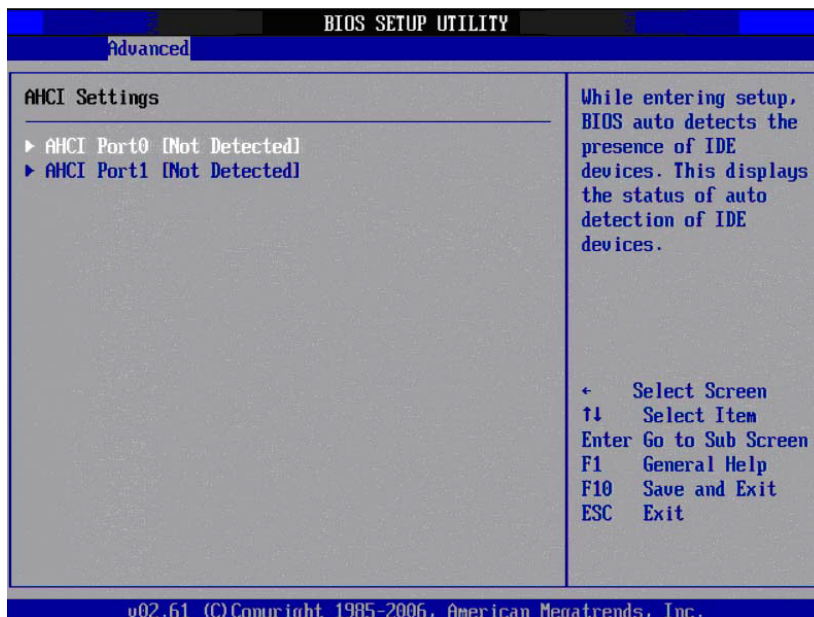

Figure 3.13 AHCI Configuration

- **AHCI Port 0 / Port 1**

When setup is initiated, the BIOS auto detects the presence of IDE devices and displays their status.

3.2.2.11 APM Configuration

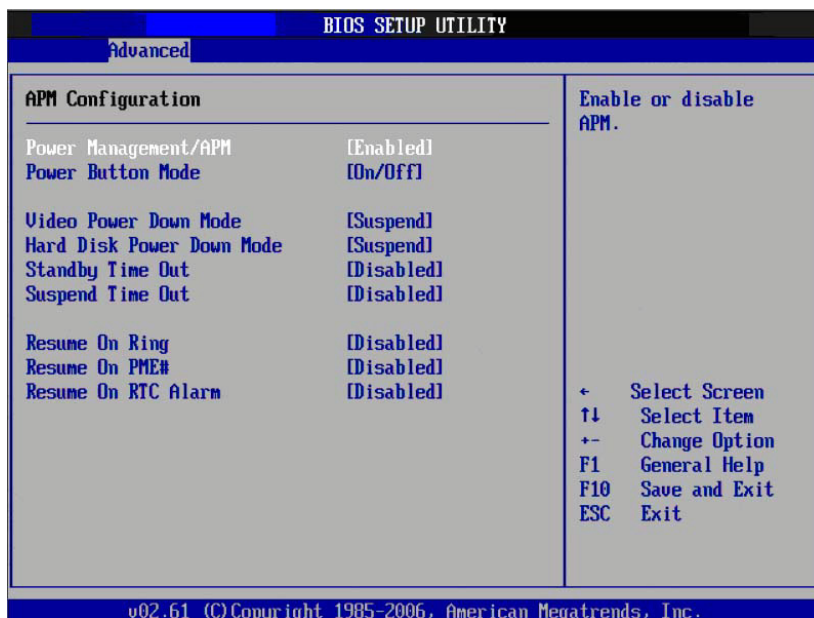

Figure 3.14 APM Configuration

- **Power Management / APM**

This item allows users to enable or disable APM.

- **Power Button Mode**

This item allows users to specify whether the system is powered on, off, or enters suspend mode when the power button is pressed. The following options are also available:

- **Video Power Down Mode**
Powers down video in suspend or standby mode.
- **Hard Disk Power Down Mode**
Powers down hard disk in suspend or standby mode.
- **Standby Time Out**
Enters standby mode at the specified time.
- **Suspend Time Out**
Enters suspend mode at the specified time.
- **Resume On Ring**
This item allows users to enable or disable RI from generating a wake event.
- **Resume On PME#**
This item allows users to enable or disable PME from generating a wake event.
- **Resume On RTC Alarm**
This item allows users to enable or disable RTC from generating a wake event.

3.2.2.12 Event Log Configuration

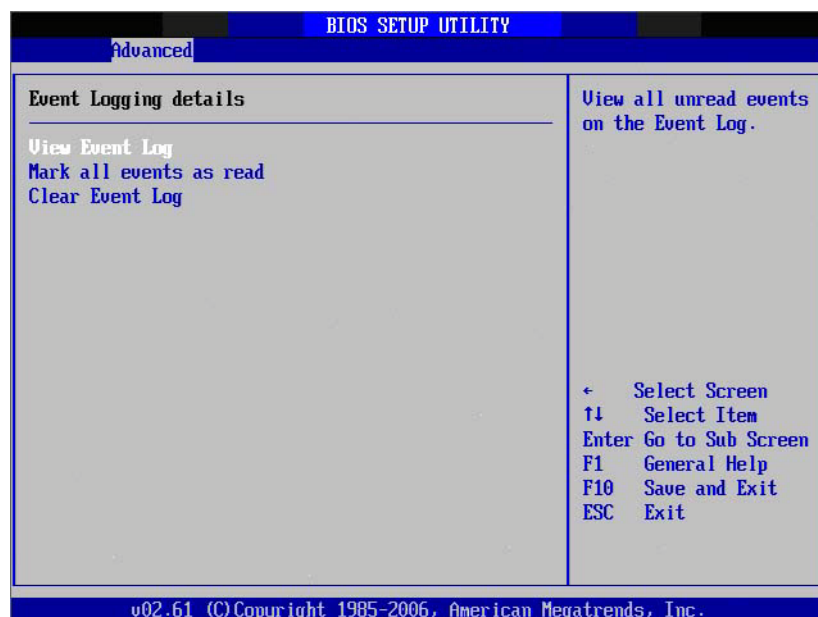

Figure 3.15 Event Log Configuration

- **View Event Log**
This item allows users to view all unread events in the event log.
- **Mark All Events as Read**
This item allows users to mark all unread events as read.
- **Clear Event Log**
This item allows users to clear all events in the event log.

3.2.2.13 MPS Configuration

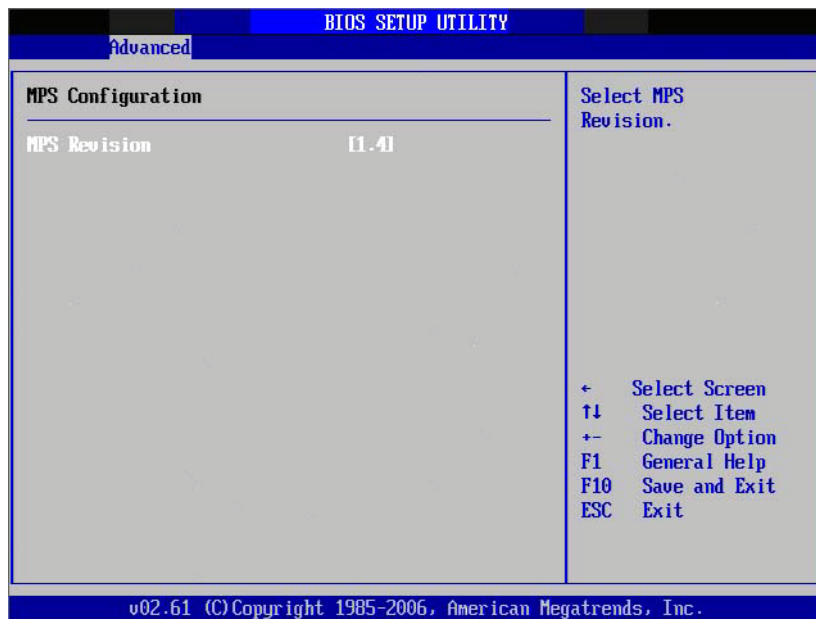

Figure 3.16 MPS Configuration

- **MPS Revision**
This item allows users to select MPS revision.

3.2.2.14 Smbios Configuration

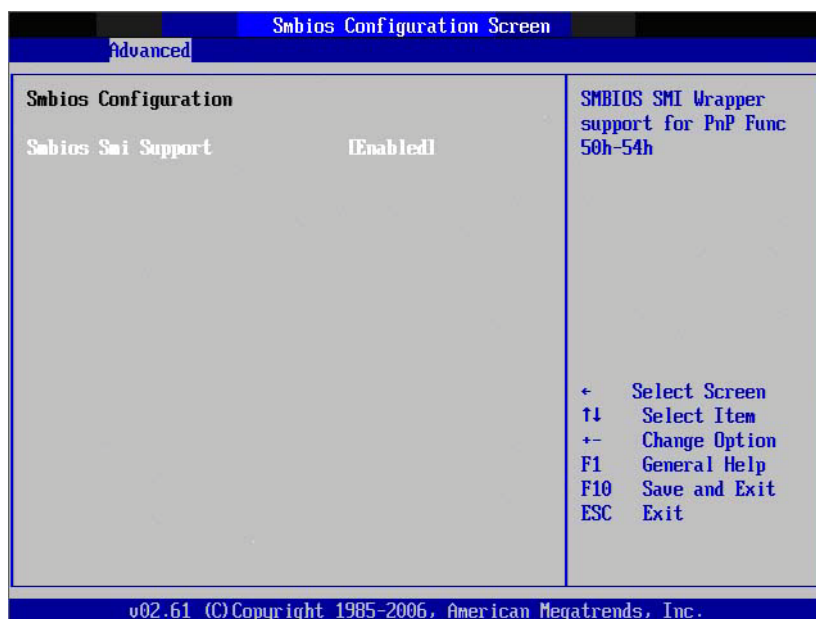

Figure 3.17 Smbios Configuration

- **Smbios Smi Support**
SMBIOS SMI wrapper support for PnP function 50 - 54h.

3.2.2.15 USB Configuration

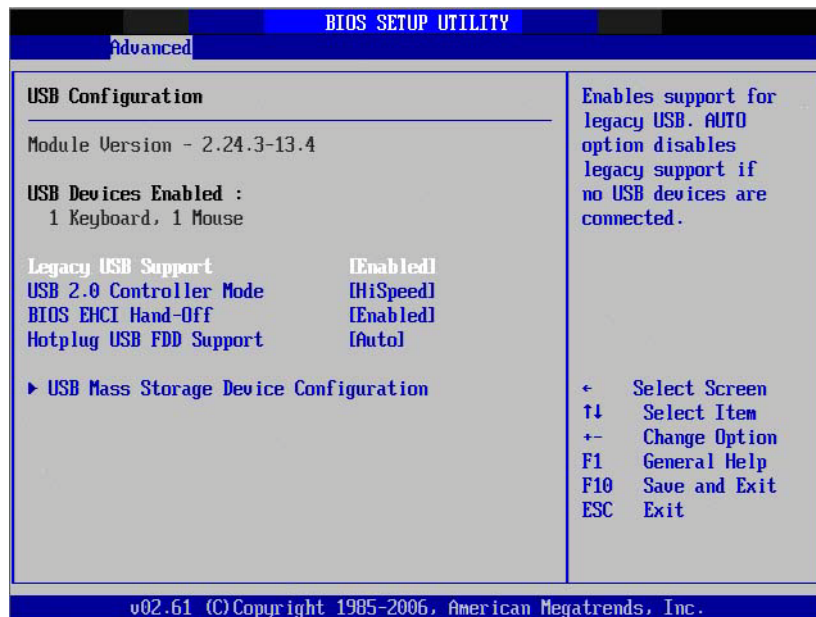

Figure 3.18 USB Configuration

- **Legacy USB Support**
This item allows users to enable legacy USB support. The "Auto" option disables legacy support if no USB devices are connected.
- **USB 2.0 Controller Mode**
This item allows users to choose between hi-speed (480 Mbps) or full-speed (12 Mbps) mode.
- **BIOS EHCI Hands Off**
This item provides a workaround for operating systems without EHCI hands off support. EHCI ownership change requests should be claimed by the EHCI driver.
- **Hotplug USB FDD Support**
A dummy FDD device can be created and associated with a hot-plugged FDD. The "Auto" option creates this dummy device only if no USB FDD is present.

3.2.2.16 USB Mass Storage Device Configuration

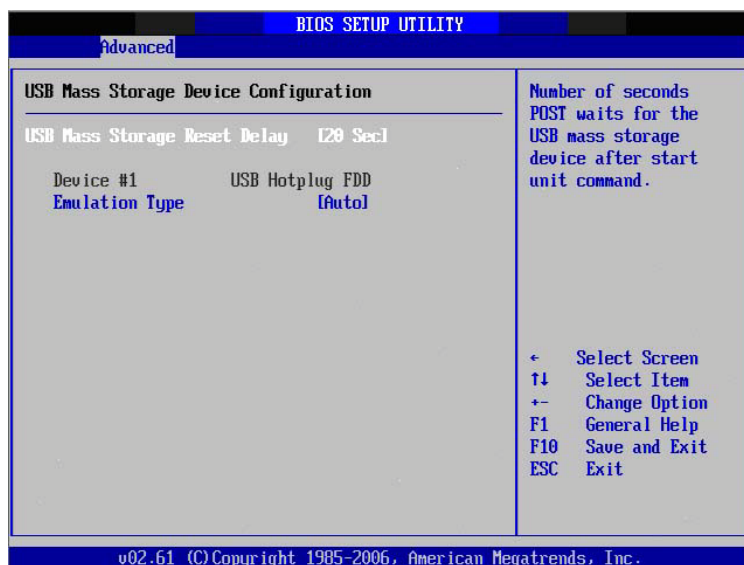

Figure 3.19 USB Mass Storage Device Configuration

- **USB Mass Storage Reset Delay**
This item allows users to specify the number of seconds that the POST waits for the USB mass storage device to initialize after executing a start unit command.
- **Emulation Type**
If this item is set to “Auto”, USB devices smaller than 530MB are emulated as floppy drives and the remaining are emulated as hard disk drives. The “Force FDD” option enables users to force an FDD-formatted drive to boot as an FDD (i.e., ZIP drive).

3.3 Advanced PCI/PnP Settings

Select the PCI/PnP tab from the SOM-4463 B2 BIOS Setup screen to enter the PnP BIOS Setup screen. Users can select a PnP BIOS Setup option by highlighting it using the <Arrow> keys. All PnP BIOS Setup options are described in this section. The PnP BIOS Setup screen is shown below.

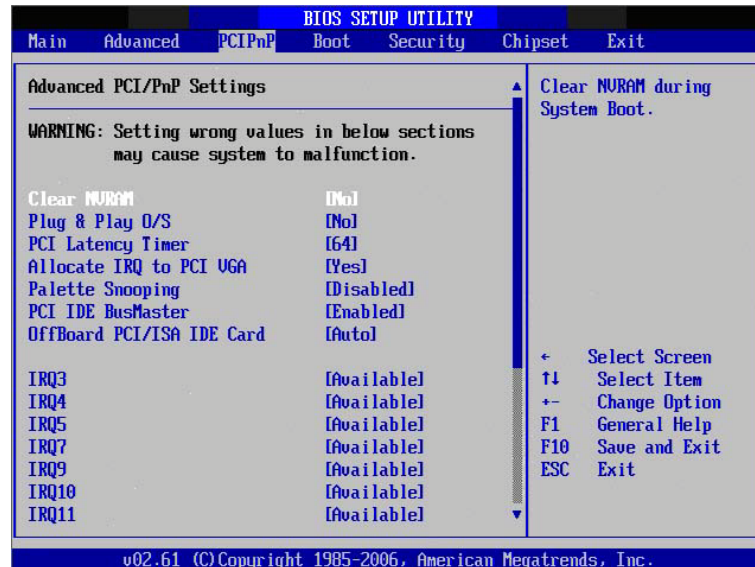

Figure 3.20 PCI/PNP Setup Screen

- **Clear NVRAM**
Users can set this item to force the BIOS to clear the non-volatile random access memory (NVRAM). The Optimal and Fail-Safe default setting is “No”.
- **Plug & Play O/S**
When this item is set to “No”, the BIOS configures all system devices. When set to “Yes”, if users install a PnP operating system, the operating system will configure the PnP devices not required for booting.
- **PCI Latency Timer**
This item allows users to select the value in units of PCI clocks for the PCI device latency timer register.
- **Allocate IRQ to PCI VGA**
When set to “Yes”, the system assigns IRQ to the PCI VGA card if the card requests an IRQ. When set to “No”, the system does not assign IRQ to the PCI VGA card even if the card requests an IRQ.
- **Palette Snooping**
This item allows users to resolve problems caused by non-standard VGA cards.
- **PCI IDE BusMaster**
When set to “Enable”, PCI bus mastering is used to read and write to IDE drives.
- **OffBoard PCI / ISA IDE Card**
Certain PCI IDE cards may require the card input PCI slot to be specified. When set to “Auto”, most PCI IDE cards are supported.
- **IRQ3 / 4 / 5 / 7 / 9 / 10 / 11**
This item allows users to assign an interruption type for IRQ-3, 4, 5, 7, 9, 10, 11.

- **DMA Channel 0 / 1 / 3 / 5 / 6 / 7**

When set to “Available”, the system specifies that DMA is available for use by PCI / PnP devices. When set to “Reserved”, the system specifies that DMA is reserved for use by legacy ISA devices.

- **Reserved Memory Size**

This item allows users to reserve a portion of the memory block for legacy ISA devices.

3.4 Boot Settings



Figure 3.21 Boot Setup Utility

3.4.1 Boot Settings Configuration



Figure 3.22 Boot Settings Configuration

- **Quick Boot**
This item allows the BIOS to skip certain tests when booting, reducing the time required to boot the system.
- **Quiet Boot**
If this option is set to “Disabled”, the BIOS displays the standard POST messages. If set to “Enabled”, an OEM logo is displayed instead of POST messages.
- **AddOn ROM Display Mode**
This item allows users to set the display mode for optional ROM.
- **Bootup Num-Lock**
This item allows users to specify the number lock power-on state.
- **PS/2 Mouse Support**
This item allows users to select PS/2 mouse support.
- **Wait For “F1” If Error**
This item allows users to set the system to wait for the F1 key to be pressed if an error occurs.
- **Hit “DEL” Message Display**
If enabled, this item allows users to press to run display Setup in POST.
- **Interrupt 19 Capture**
This item allows users to authorize optional ROMs to trap Interrupt 19.

3.5 Security Setup

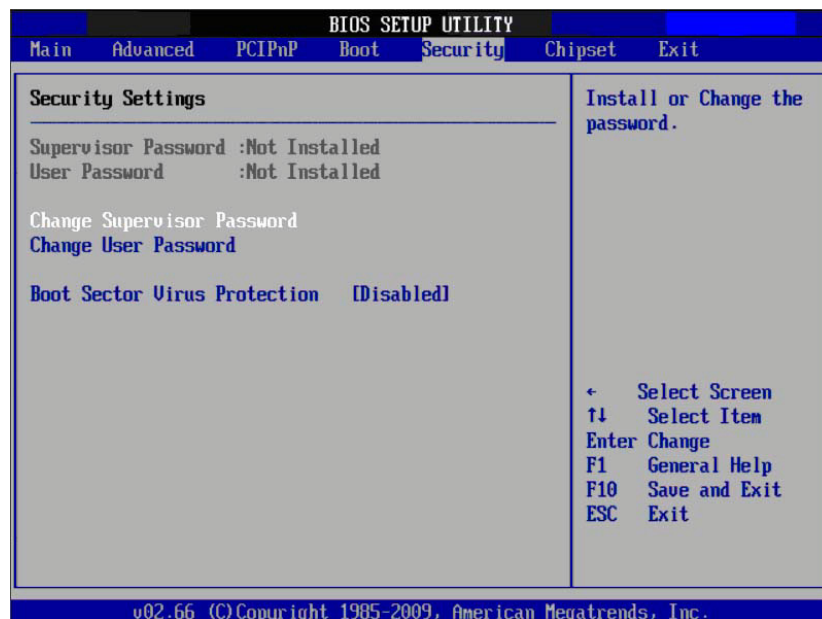

Figure 3.23 Password Configuration

Select the Security tab from the SOM-4463 B2 BIOS Setup menu. All Security options, including password protection and virus protection, are described in this section. To access the submenu for the following items, select the item and press <Enter>:

- **Change Supervisor / User Password**
Select this option and press <Enter> to access the submenu; then input a password.

- **Boot Sector Virus protection**

The boot sector virus protection function will warn users if any program tries to write to the boot sector.

3.6 Advanced Chipset Settings



Figure 3.24 Advanced Chipset Settings

3.6.1 North Bridge Chipset Configuration

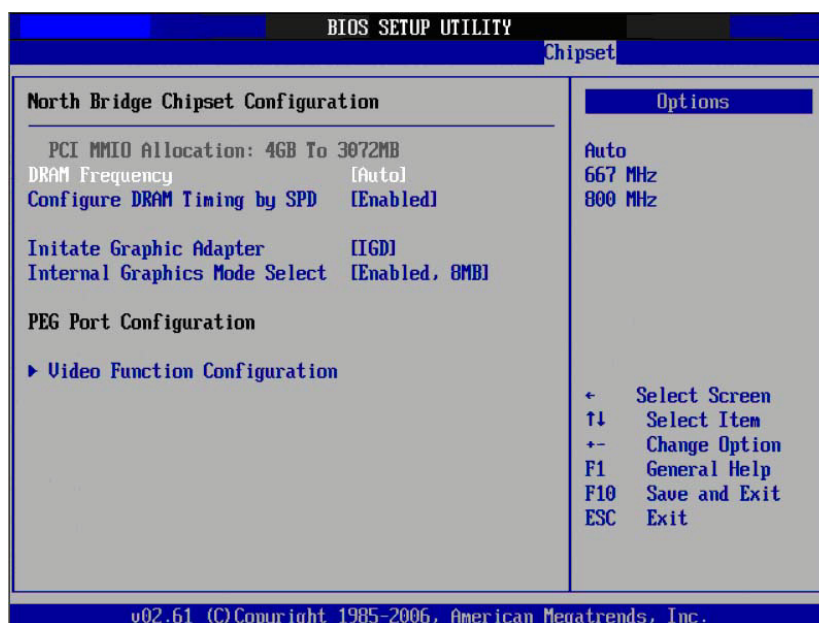

Figure 3.25 North Bridge Configuration

- **DRAM Frequency**

This item allows users to manually adjust the DRAM frequency.

- **Configure DRAM Timing by SPD**

This item allows users to enable or disable detection by DRAM SPD.

- **Memory Hole**
This item allows users to reserve 15 ~ 16MB of memory for ISA devices.
- **Initiate Graphic Adapter**
This item allows users to specify which graphics controller to use as the primary boot device.
- **Internal Graphics Mode Select**
This item allows users to specify the amount of system memory that can be used by the internal graphics device.

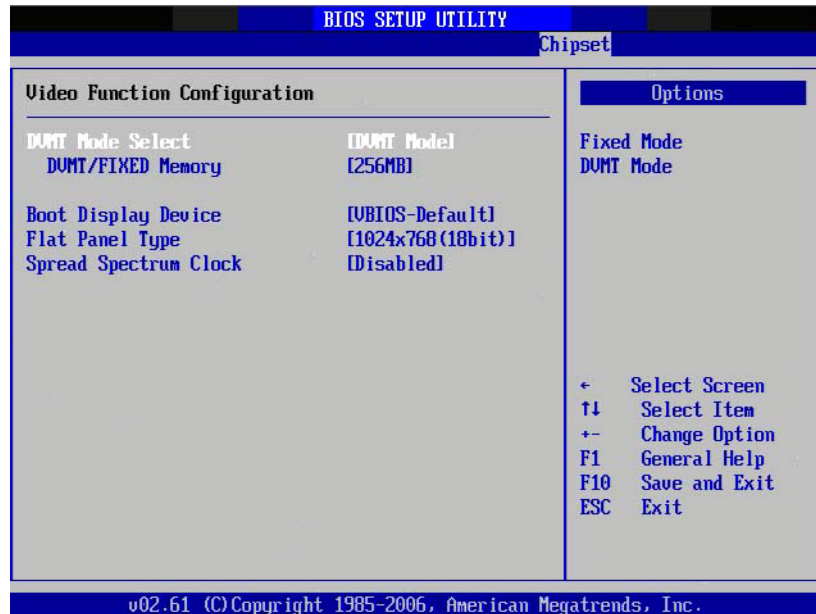

Figure 3.26 Video Function Configuration

- **DVMT Mode Select**
Displays the active system memory mode.
- **DVMT / FIXED Memory**
This item allows users to specify the amount of DVMT / FIXED system memory to allocate for video memory.
- **Boot Display Device**
This item allows users to select the boot display device at the POST stage.
- **Flat-Panel Display Type**
This item allows users to set the resolution of flat-panel displays.
- **Spread Spectrum Clock**
This item allows users to enable or disable the spread spectrum clock.

3.6.2 South Bridge Chipset Configuration

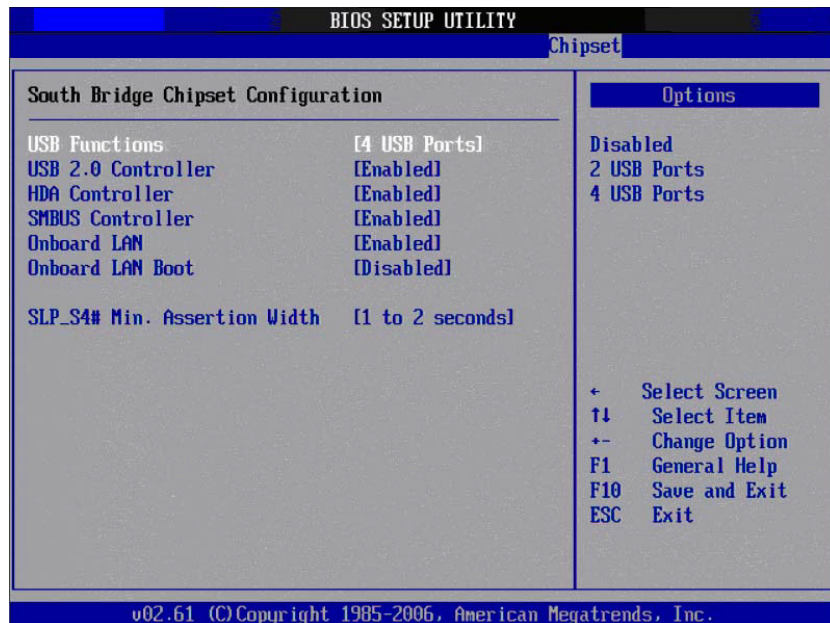

Figure 3.27 South Bridge Configuration

- **USB Functions**
Disabled, 2 USB Ports, 4 USB Ports
- **USB 2.0 Controller**
This item allows users to enable or disable the USB 2.0 controller.
- **HDA Controller**
This item allows users to enable or disable the HDA controller.
- **SMBUS Controller**
This item allows users to enable or disable the SMBUS controller.
- **SLP_S4# Min. Assertion Width**
This item allows users to set a delay of sorts.

3.7 Exit Options

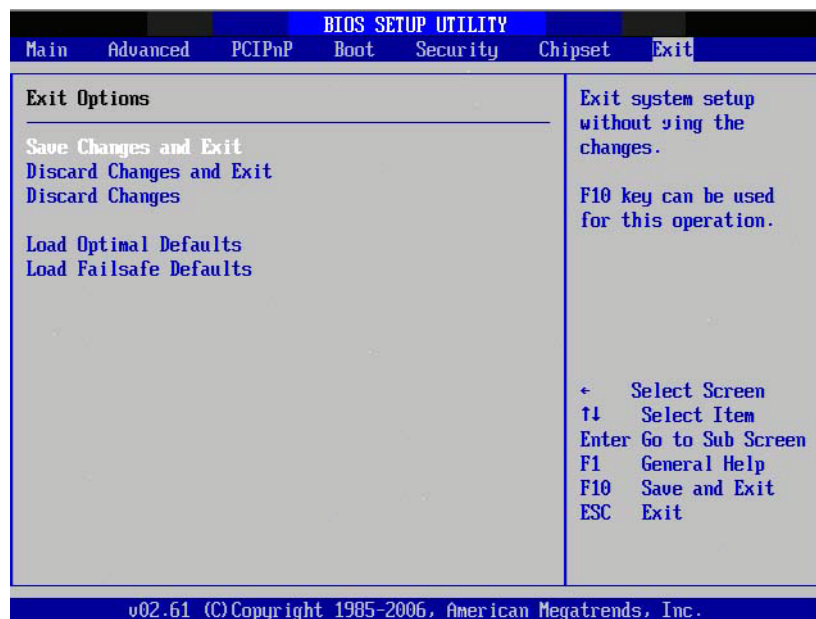

Figure 3.28 Exit Options

- **Save Changes and Exit**

After completing the system configuration, select this option to save changes and exit the BIOS setup menu. Next, reboot the computer to implement all system configuration parameters.

 1. Select the “Save Changes and Exit” option from the Exit menu and press <Enter>. This generates the following message: Save Configuration Changes and Exit Now? [OK] [Cancel]
 2. Select “OK” or “Cancel”.
- **Discard Changes and Exit**

Select this option to exit the BIOS setup menu without making permanent changes to the system configuration.

 1. Select the “Discard Changes and Exit” option from the Exit menu and press <Enter>. This generates the following message: Discard Changes and Exit Setup Now? [OK] [Cancel]
 2. Select “OK” to discard changes and exit.
- **Discard Changes**

Select this option to discard changes to the system configuration without exiting the BIOS setup menu.

 1. Select the “Discard Changes” option from the Exit menu and press <Enter>.
- **Load Optimal Defaults**

All setup items are automatically configured with their optimal settings when this option is selected. Optimal defaults are designed for maximum system performance, but may not be ideal for all computer applications. Specifically, do not use optimal defaults if your computer is experiencing system configuration problems. To enable this item setting, select the “Load Optimal Defaults” option from the Exit menu and press <Enter>.
- **Load Fail-Safe Defaults**

All setup items are automatically configured to their fail-safe settings when this option is selected. Fail-Safe defaults are designed for maximum system stability,

but not maximum performance. Users are advised to select fail-safe defaults if experiencing system configuration problems.

- 1 Select the “Load Fail-Safe Defaults” option from the Exit menu and press <Enter>. This generates the following message: Load Fail-Safe Defaults? [OK] [Cancel]
- 2 Select “OK” to load fail-safe defaults.

Chapter 4

Driver Installation

This chapter provides driver installation information.

- Driver Introduction
- Driver Installation

4.1 Driver Introduction

The CD shipped with SOM-4463 B2 should contain the drivers listed below. Please adhere to the following sequence to complete the driver installation process:

Step 1- Install Intel INF Update Driver

Step 2- Install Intel Graphic Driver

Step 3- Install Audio Driver

Step 4- Install Intel Ethernet Driver

Step 5- Install IT8888 PCI to ISA Driver

Note! *For Windows XP Embedded, Windows CE 5.0, and Linux support, please contact an Advantech sales representative or technical personnel.*



Note! *A Windows XP update may be required to enable USB 2.0 function. Please refer to Web link below for detailed information.*



<http://www.microsoft.com/whdc/system/bus/USB/USB2support.mspx>

4.2 Driver Installation

Product drivers for various OS are provided and can be updated from the website link shown below. Please search by product model name.

<http://support.advantech.com.tw>

The image shows a CD-ROM on the left and a screenshot of the Advantech website on the right. An arrow points from the CD to the website. The CD is labeled "Drivers & Manuals for Embedded Computing Platform" and "Embedded Computing Group". The website screenshot shows the "Support & Download" section with a search bar and navigation links.

Appendix **A**

Watchdog Timer

This appendix provides information about the watchdog timer programming functions.

- Programming the Watchdog Timer

A.1 Programming the Watchdog Timer

Sample code for programming the watchdog timer function:

Enter the extended function mode, interruptible double-write

```
MOV DX,2EH
MOV AL,87H
OUT DX,AL
OUT DX,AL
```

Configured logical device 8, configuration register CRF6

```
MOV DX,2EH
MOV AL,2BH
OUT DX,AL
MOV DX,2FH
IN AL,DX
AND AL,OEF; set bit 4 = 0 Pin 89 = WDTO
OUT DX,AL
MOV DX,2EH
MOV AL,07H; point to Logical Device Number Reg.
OUT DX,AL
MOV DX,2FH
MOV AL,08H; select logical device 8
OUT DX,AL;
MOV DX,2EH
MOV AL,30H; set the watchdog to activate or inactivate
OUT DX,AL
MOV DX,2FH
MOV AL,01H; 01: activate 00: inactivate
OUT DX,AL;
MOV DX,2EH
MOV AL,F5H; the setting counter unit is seconds
OUT DX,AL
MOV DX,2FH
MOV AL,00H
OUT DX,AL;
MOV DX,2EH
MOV AL,F6H
OUT DX,AL
MOV DX,2FH
MOV AL,05H; set to 5 seconds
OUT DX,AL
```

;-----

; Exit the extended function mode |

;-----

MOV DX,2EH

MOV AL,AAH

OUT DX,AL

Appendix **B**

System Assignments

This appendix details the system resource allocation.

- System I/O Ports
- DMA Channel Assignments
- Interrupt Assignments
- System Memory Map

B.1 System I/O Ports

Table B.1: System I/O Ports

I/O Address (Hex)	
0000 - 000F	Direct memory access controller
0000 - 0CF7	PCI bus
0010 - 001F	Motherboard resources
0020 - 0021	Programmable interrupt controller
0022 - 003F	Motherboard resources
0040 - 0043	System timer
0044 - 005F	Motherboard resources
0060 - 0060	Standard 101/102-key or Microsoft Natural PS/2 keyboard
0061 - 0061	System speaker
0062 - 0063	Motherboard resources
0064 - 0064	Standard 101/102-key or Microsoft Natural PS/2 keyboard
0065 - 006F	Motherboard resources
0070 - 0071	System CMOS / real-time clock
0072 - 007F	Motherboard resources
0080 - 0080	Motherboard resources
0081 - 0083	Direct memory access controller
0084 - 0086	Motherboard resources
0087 - 0087	Direct memory access controller
0088 - 0088	Motherboard resources
0089 - 008B	Direct memory access controller
008C - 008E	Motherboard resources
008F - 008F	Direct memory access controller
0090 - 009F	Motherboard resources
00A0 - 00A1	Programmable interrupt controller
00A2 - 00BF	Motherboard resources
00C0 - 00DF	Direct memory access controller
00E0 - 00EF	Motherboard resources
00F0 - 00FF	Numeric data processor
01F0 - 01F7	Primary IDE channel
0274 - 0277	ISAPNP Read Data Port
0279 - 0279	ISAPNP Read Data Port
0280 - 028F	Motherboard resources
0290 - 029F	Motherboard resources
02F8 - 02FF	Communications Port (COM 2)
0378 - 037F	Printer Port (LPT1)
03B0 - 03BB	Intel Graphics Media Accelerator 3150
03C0 - 03DF	Intel Graphics Media Accelerator 3150
03F6 - 03F6	Primary IDE channel
03F8 - 03FF	Communications Port (COM1)
0400 - 041F	Intel ICH8 Family SMBus Controller - 283E
04D0 - 04D1	Motherboard resources
0500 - 053F	Motherboard resources
0800 - 087F	Motherboard resources

Table B.1: System I/O Ports

0A00 - 0A0F	Motherboard resources
0A79 - 0A79	ISAPNP Read Data Port
0D00 - FFFF	PCI bus
C800 - C807	Intel Graphics Media Accelerator 3150
C880 - C89F	Intel ICH8 Family USB Universal Host Controller - 2831
CC00 - CC1F	Intel ICH8 Family USB Universal Host Controller - 2830
D080 - D08F	Intel ICH8M three-port Serial ATA Storage Controller - 2828
D400 - D40F	Intel ICH8M three-port Serial ATA Storage Controller - 2828
D480 - D483	Intel ICH8M three-port Serial ATA Storage Controller - 2828
D800 - D807	Intel ICH8M three-port Serial ATA Storage Controller - 2828
D880 - D883	Intel ICH8M three-port Serial ATA Storage Controller - 2828
DC00 - DC07	Intel ICH8M three-port Serial ATA Storage Controller - 2828
EO00 - EFFF	Intel ICH8 Family PCI-E Root Port 5 - 2847
E800 - E8FF	Realtek PCIe FE Family Controller
FFA0 - FFAF	Intel ICH8M Ultra ATA Storage Controller - 2850

B.2 DMA Channel Assignments

Table B.2: DMA Channel Assignments

Channel	Function
0	Available
1	Available
2	Available
3	Available
4	Direct memory access controller
5	Available
6	Available
7	Available

B.3 Interrupt Assignments

Table B.3: Interrupt Assignments

Interrupt#	Interrupt source
IRQ 0	System timer
IRQ 1	Standard 101/102-key or Microsoft Natural PS/2 keyboard
IRQ 2	Available
IRQ 3	Communications Port (COM 2)
IRQ 4	Communications Port (COM 1)
IRQ 5	Available
IRQ 6	Available
IRQ 7	Available
IRQ 8	System CMOS/ real-time clock
IRQ 9	Microsoft ACPI-compliant system
IRQ 10	Intel ICH8 Family SMBus Controller - 283E
IRQ 11	Available
IRQ 12	PS/2-compatible Mouse
IRQ 13	Numeric data processor
IRQ 14	Primary IDE channel
IRQ 15	Available
IRQ 16	Intel Graphics Media Accelerator 3150
IRQ 16	Realtek PCIe FE Family Controller
IRQ 18	Intel ICH8M three-port Serial ATA Host Controller - 2828
IRQ 19	Intel ICH8 Family USB Universal Host Controller - 2831*
IRQ 21	Microsoft UAA Bus Driver for High Definition Audio
IRQ 22	Intel ICH8 Family PCI-E Root Port 1 - 283F
IRQ 22	Intel ICH8 Family PCI-E Root Port 5 - 2847
IRQ 23	Intel ICH8 Family USB Universal Host Controller - 2830*
IRQ 23	Intel ICH8 Family USB Universal Host Controller - 2836*

*USB and Ethernet IRQ is automatically set by the system.

B.4 System Memory Map

Table B.4: System Memory Map	
Address range (Hex)	Device
00000000 - 0009FFFF	System board
000A0000 - 000BFFFF	Intel Graphics Media Accelerator 3150
000A0000 - 000BFFFF	PCI Bus
000C0000 - 000CFFFF	System board
000D0000 - 000DFFFF	PCI Bus
000E0000 - 000FFFFFF	System board
00100000 - 3F6FFFFFF	System board
3F700000 - DFFFFFFF	PCI Bus
D0000000 - DFFFFFFF	Intel Graphics Media Accelerator 3150
E0000000 - EFFFFFFF	Motherboard resource
F0000000 - FED8FFFF	PCI Bus
FDF00000 - FDFFFFFF	Intel ICH8 Family PCI-E Root Port 5 - 2847
FDF00000 - FDFFFFFF	Realtek PCIe FE Family Controller
FE880000 - FE8FFFFF	Intel Graphics Media Accelerator 3150
FE900000 - FE9FFFFF	Intel Graphics Media Accelerator 3150
FEAC0000 - FEA7FFFF	Intel Graphics Media Accelerator 3150
FEAF8000 - FEAFBFFF	Microsoft UAA Bus Driver for high-definition audio
FEAFF800 - FEAFBFFF	Intel ICH8 Family USB2 Enhanced Host Controller - 2836
FEAFFC00 - FEAFFCFF	Intel ICH8 Family SMBus Controller - 283E
FEB00000 - FEBFFFFF	Intel ICH8 Family PCI-E Root Port 5 - 2847
FEBFF000 - FEBFFFFF	Realtek PCIe FE Family Controller
FEC00000 - FEC0FFFF	Motherboard resources
FED14000 - FED19FFF	System board
FED1C000 - FED1FFFF	Motherboard resources
FED20000 - FED3FFFF	Motherboard resources
FED40000 - FED8FFFF	Motherboard resources
FED90000 - FED93FFF	System board
FED90000 - FFFFFFFF	System board
FEE00000 - FEE0FFFF	Motherboard resources

ADVANTECH

Enabling an Intelligent Planet

www.advantech.com

Please verify specifications before quoting. This guide is intended for reference purposes only.

All product specifications are subject to change without notice.

No part of this publication may be reproduced in any form or by any means, electronic, photocopying, recording or otherwise, without prior written permission from the publisher.

All brand and product names are trademarks or registered trademarks of their respective companies.

© Advantech Co., Ltd. 2014