

DETAILS

Product Number	F14487_FLORENCE-1R-MAXI-WG
Family	Florence
Type	Lens
Color	clear
Diameter	21,65 x 286 mm
Height	11,04 mm
Style	rectang
Optic Material	PMMA
Holder Material	
Fastening	
Status	production ready
ROHS Compliant	Yes
Date Updated	21/12/2016



OPTICAL PROPERTIES

LED	Viewing Angle	Light Beam	Efficiency	cd/lm	Connector
L0-280024-xxx-C0800-L267	asymmetric deg	Asymmetric	90 %	0.770	-
XP-G	Asymmetric deg	Asymmetric	92 %	1.400	-
XP-E2	asymmetric deg	Asymmetric	94 %	1.470	-
XP-E	Asymmetric deg	Asymmetric	91 %	1.700	-
XB-H	sim: Asymmetric	Asymmetric	sim: 90 %	-	-
XQ-E	asymmetric deg	Asymmetric	94 %	1.580	-
XP-G2	Asymmetric deg	Asymmetric	93 %	1.500	-
XQ-E HI	sim: Asymmetric	Asymmetric	sim: 91 %	sim: 2.460	-
LUXEON Rebel ES	Asymmetric deg	Asymmetric	92 %	1.300	-
LUXEON T	sim: Asymmetric	Asymmetric	sim: 90 %	-	-
LUXEON R	sim: Asymmetric	Asymmetric	sim: 88 %	-	-
LUXEON Rebel	Asymmetric deg	Asymmetric	92 %	1.400	-
LUXEON A	Asymmetric deg	Asymmetric	92 %	1.400	-
LUXEON Z ES	asymmetric deg	Asymmetric	94 %	1.300	-
LUXEON TX	sim: Asymmetric	Asymmetric	sim: 91 %	-	-
LUXEON 3030 2D	Asymmetric deg	Asymmetric	91 %	1.000	-
LUXEON 3014	Asymmetric deg	Asymmetric	93 %	1.500	-
NCSxx19B	Asymmetric deg	Asymmetric	91 %	1.300	-
NF2x757A	sim: Asymmetric	Asymmetric	sim: 89 %	-	-
NVSxx19B/NVSxx19C	Asymmetric deg	Asymmetric	91 %	1.200	-
NF2x757G	asymmetric deg	Asymmetric	90 %	1.040	-
Duris S5 (2 chip)	Asymmetric deg	Asymmetric	91 %	1.100	-
Oslon SSL 80	Asymmetric deg	Asymmetric	93 %	1.700	-
Duris E 2835	sim: Asymmetric	Asymmetric	sim: 94 %	sim: 1.500	-
Fortimo LED Line 1ft 1100lm xx0 1R xv2	Asymmetric deg	Asymmetric	94 %	0.940	-



PRODUCT DATASHEET

Florence series

last update 21/12/2016

OPTICAL PROPERTIES

LED	Viewing Angle	Light Beam	Efficiency	cd/lm	Connector
LT-S282N	Asymmetric deg	Asymmetric	94 %	1.200	-
LM301A	Asymmetric deg	Asymmetric	91 %	1.100	-
LM561C	asymmetric deg	Asymmetric	94 %	1.130	-
LM28xB Series	Asymmetric deg	Asymmetric	93 %	1.100	-
CALGD0414-M8W1	asymmetric deg	Asymmetric	92 %	1.050	-
CALGD0814-M17W1	asymmetric deg	Asymmetric	92 %	1.040	-

H G F E D C B A

4

4

285.6

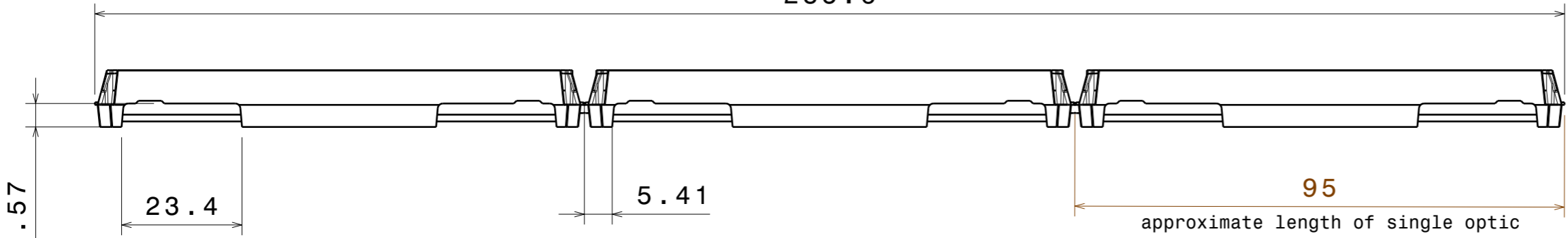

Left view

3

3

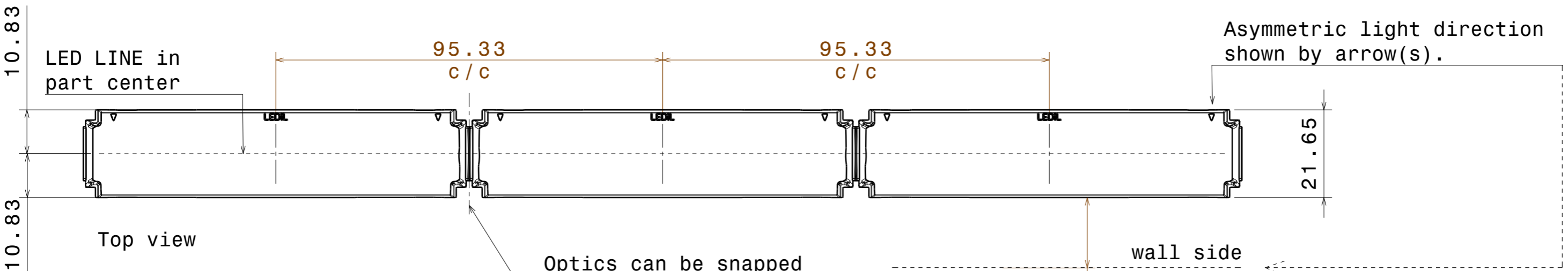

Top view

2

2

Highly recommended to cover wall-side wire outlet with light fixture to avoid reflections from components.
Cover max level = lens top level to avoid blocking light from the wall.

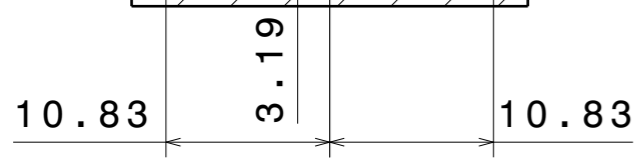
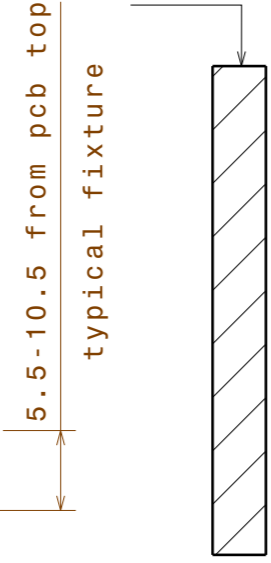

INDEX	PART NO	DESCRIPTION	MATERIAL	COLOUR
1	C14487	FLORENCE-1R-MAXI-WG	PMMA	clear

Tolerances if not otherwise shown
According to DIN ISO 2768-1
Linear measures: class M
According to DIN ISO 2768-2
Form and position: class L

LEDiL LediL Oy
Salorankatu 10
FIN 24240 SALO
Finland

THIRD ANGLE PROJECTION:

DRAWING TITLE
C14487_FLORENCE-1R-MAXI-WG

This drawing is the property of LEDiL Oy. It may not be reproduced, copied or communicated without a written agreement with LEDiL Oy.

SIZE PART NUMBER
A3 C14487

SCALE 1:1 WEIGHT SHEET 1/1

H G B A

Luminaire: Ledil F14487_FLORENCE-1R-MAXI-WG_(CeZos)

Lamps: 1 x CeZos_(L0-280024-xxx-C0800-L267)_1346.29lm@250mA_CCT=3000K_P=8.5017W_I=0.25A

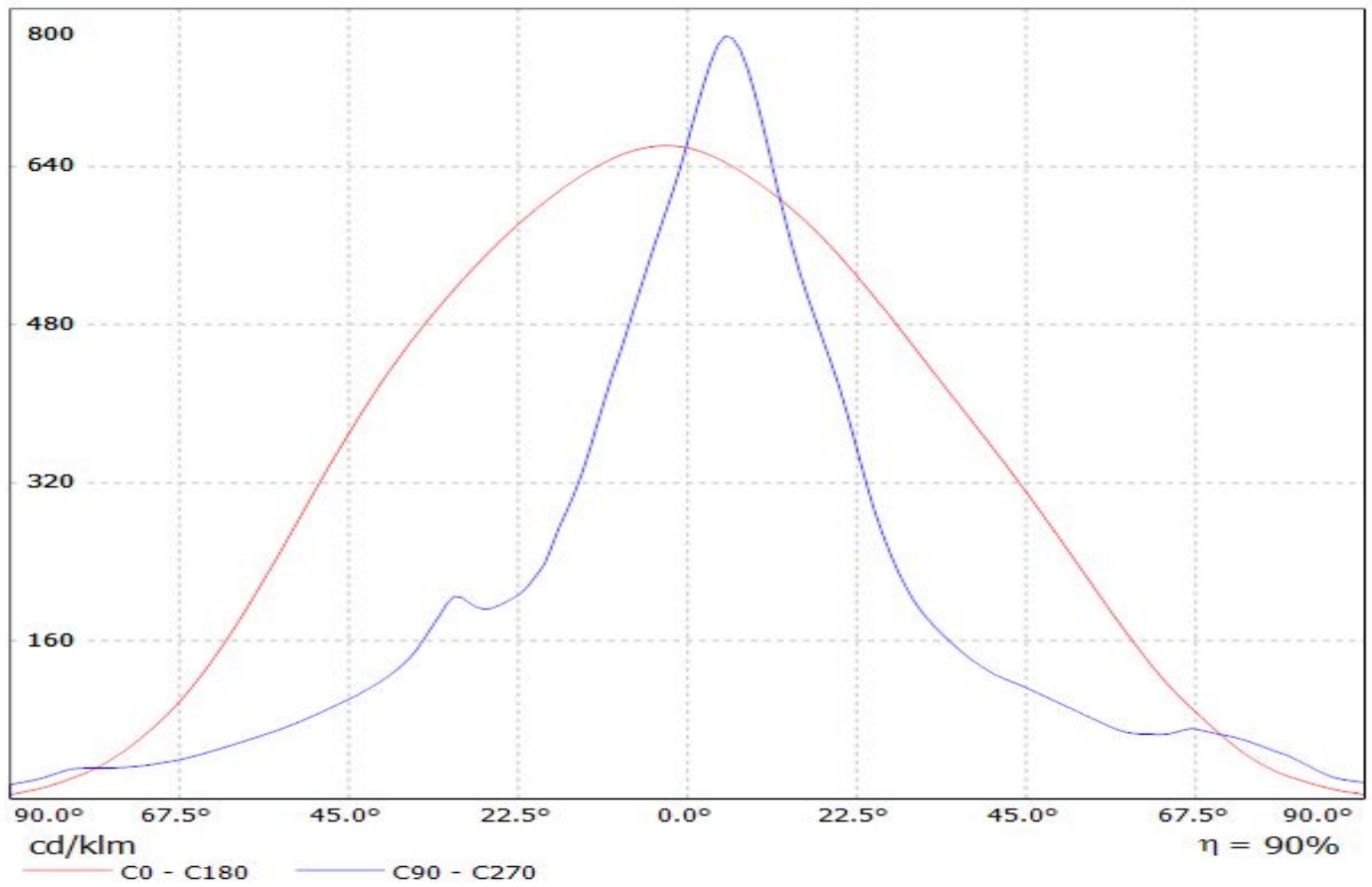

Ledil F14487_FLORENCE-1R-MAXI-WG_(XP-G) / LDC (Linear)

Luminaire: Ledil F14487_FLORENCE-1R-MAXI-WG_(XP-G)

Lamps: 1 x Cree_XP-G_x12_(XPGWHT-L1-CWPI-00BE7)_795.108lm@250mA_P=8.6W_I=0.25A

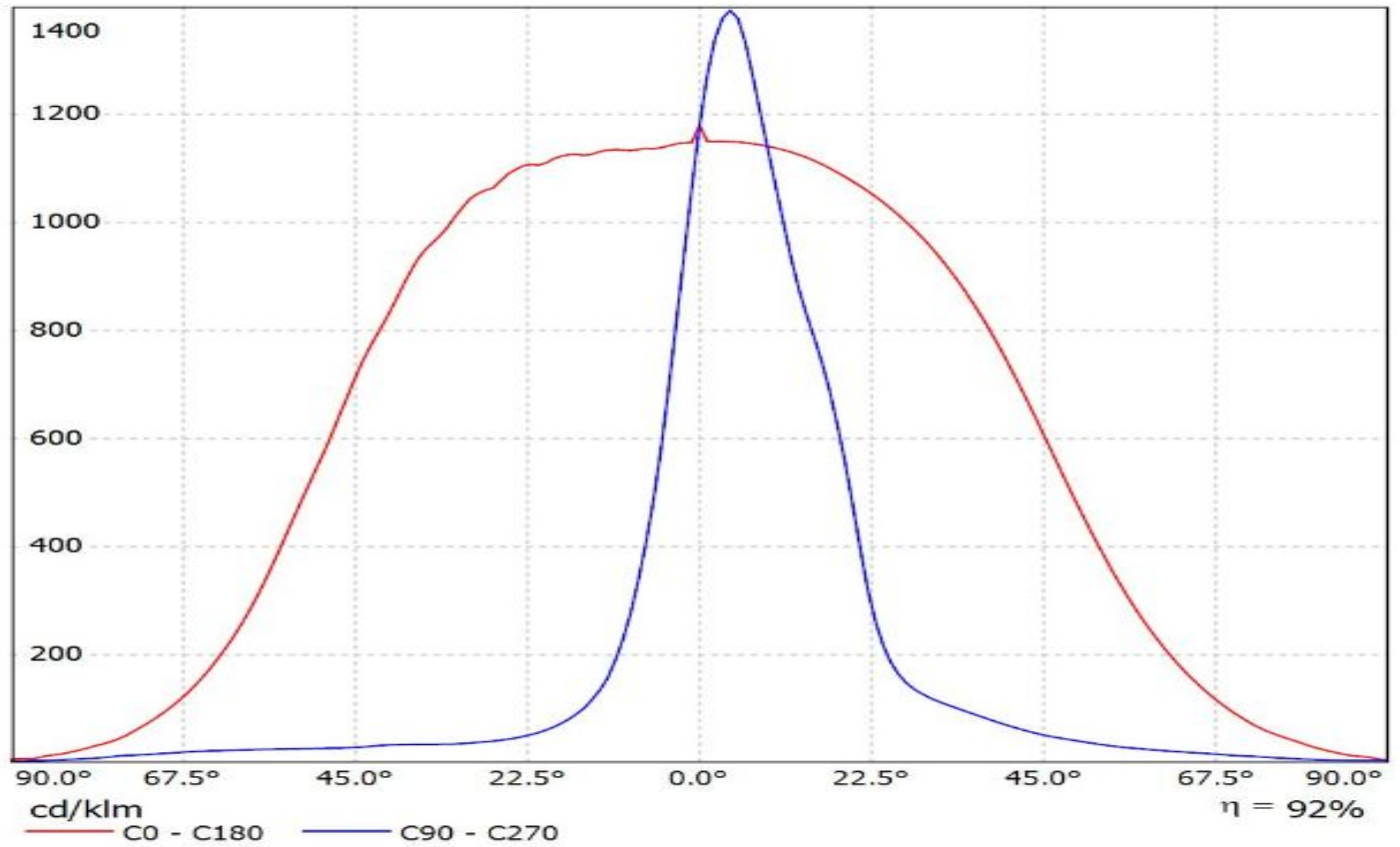

Luminaire: LEDiL Oy F14487_FLORENCE-1R-MAXI-WG_(XP-E2)_2
Lamps: 1 x (XP-E2_florence)_881.969lm@250mA_P=8.62385W_I=0.2498mA

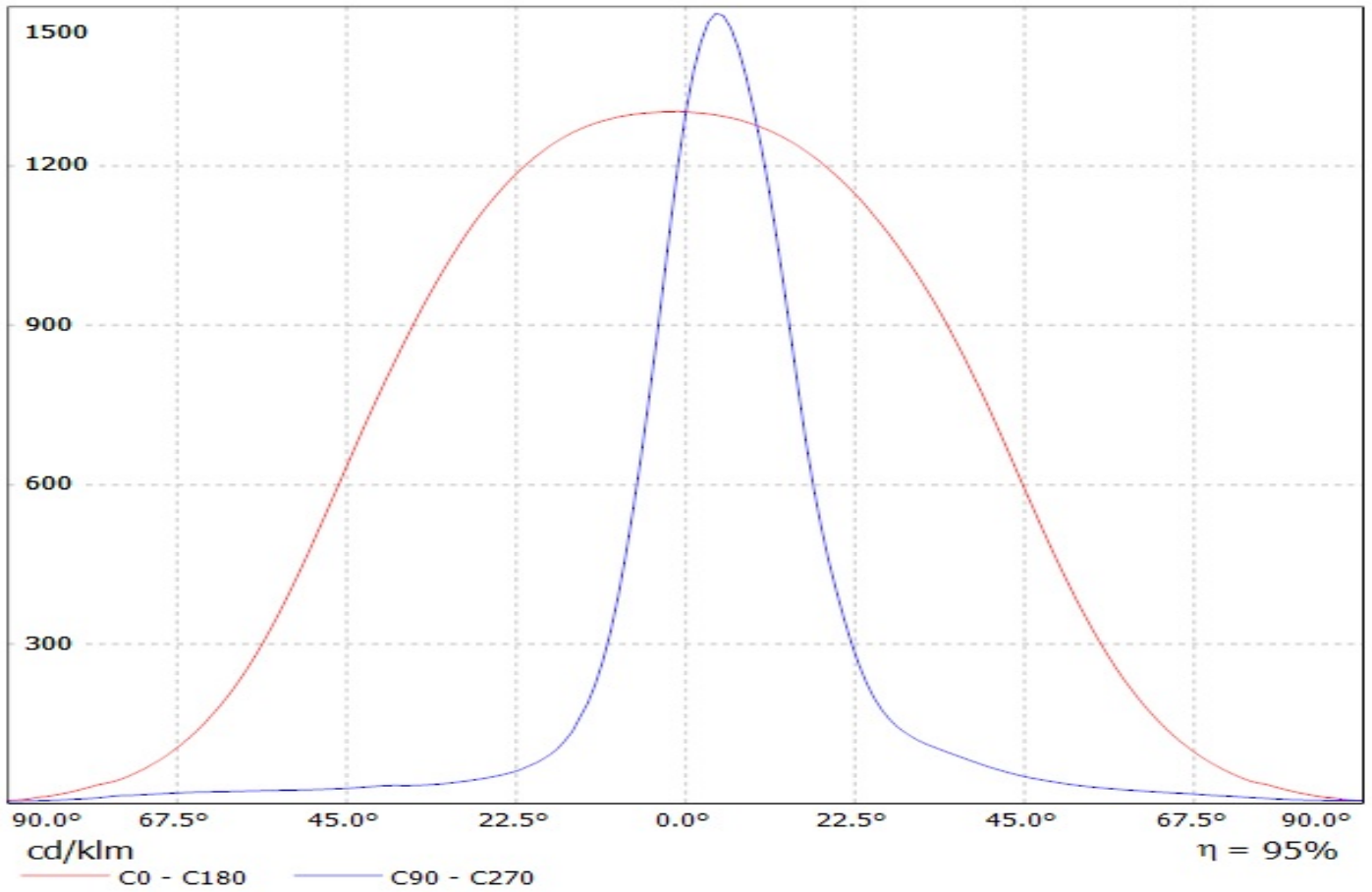

Ledil F14487_FLORENCE-1R-MAXI-WG_(XP-E) / LDC (Linear)

Luminaire: Ledil F14487_FLORENCE-1R-MAXI-WG_(XP-E)

Lamps: 1 x Cree_XP-E_x12_(XPEWHT-L1-3C0-Q5-0-06)_941.258lm@250mA_P=9W_I=0.25A

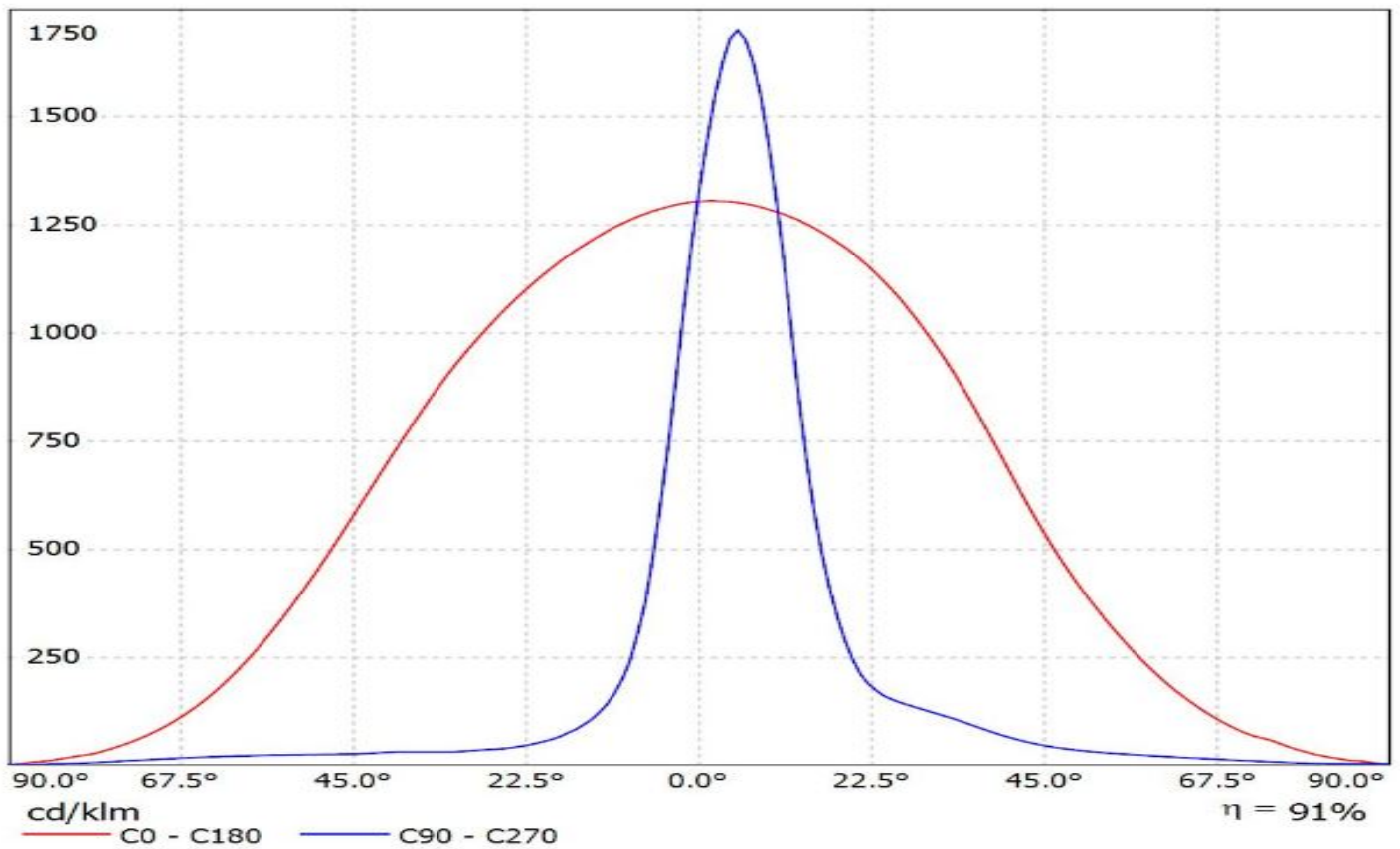

Luminaire: LEDiL Oy F14487_FLORENCE-1R-MAXI-WG_(XQ-E)

Lamps: 1 x CREE_XQ-E_(XQEAWT-0-7B1-Q40-0H-00001)_872.003lm@250mA_P=8.58163W_I=249.8mA

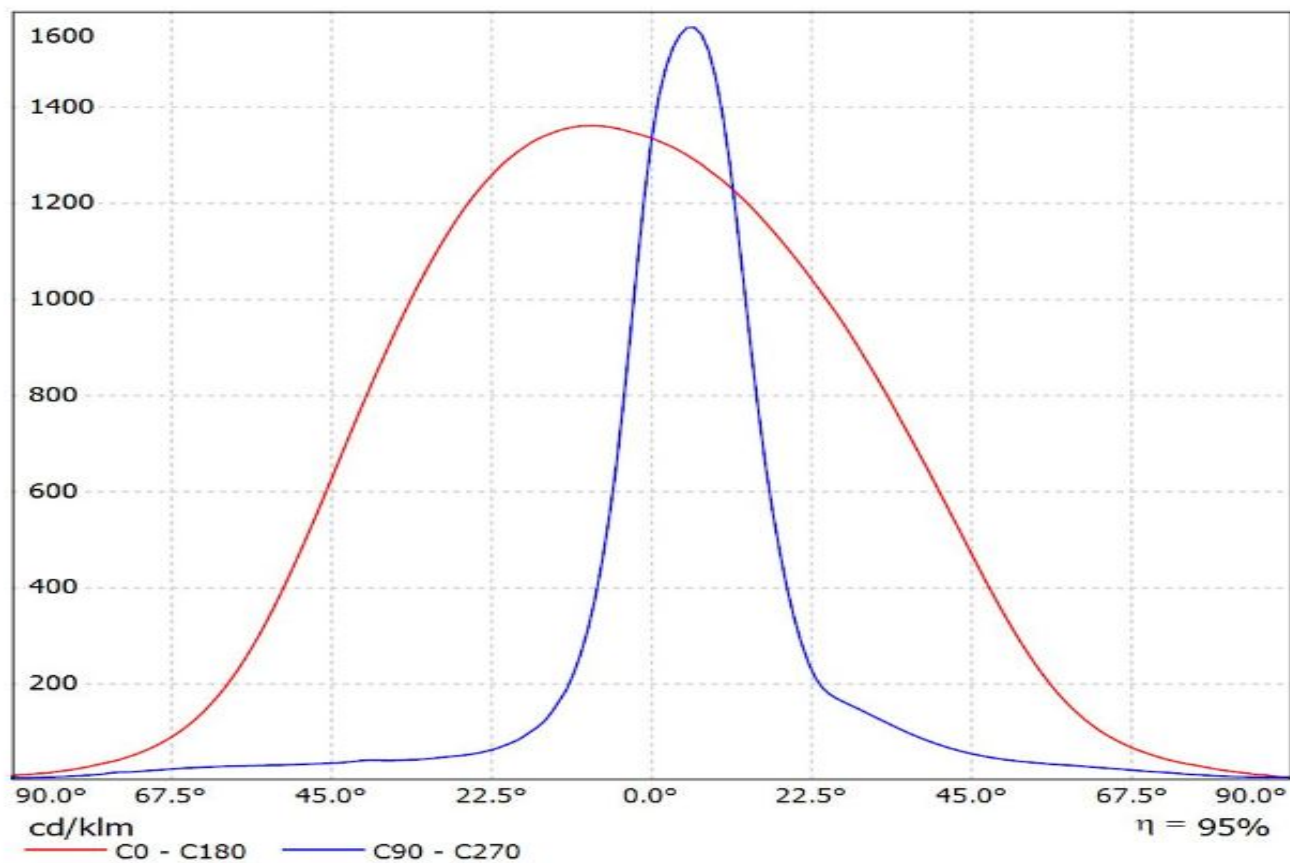

Ledil F14487_FLORENCE-1R-MAXI-WG_(XP-G2) / LDC (Linear)

Luminaire: Ledil F14487_FLORENCE-1R-MAXI-WG_(XP-G2)

Lamps: 1 x Cree_XP-G2_x12_(XPGBWT-01-4A0-R3-0-01)_1206.16lm@250mA_P=8.5W_I=0.25A

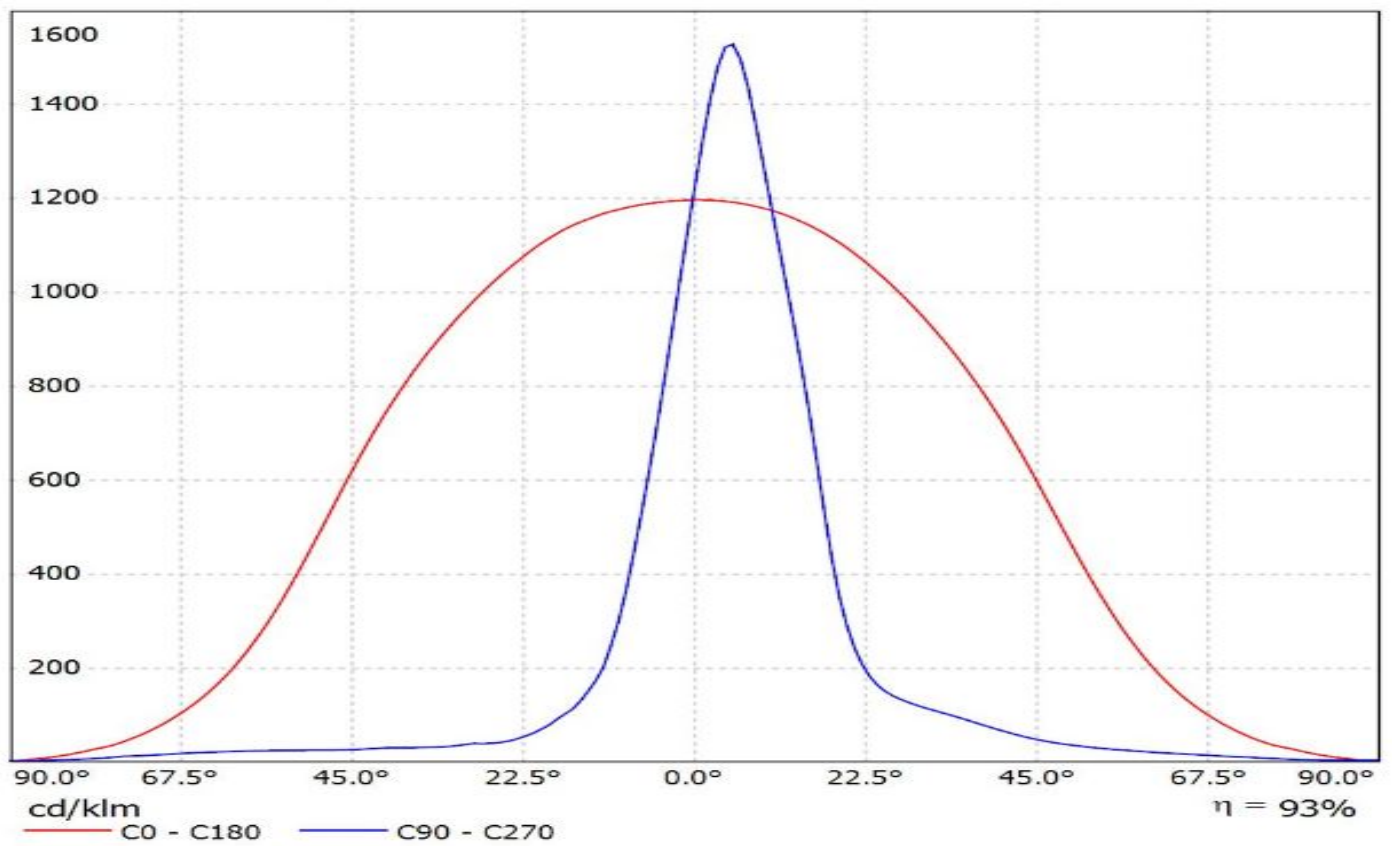

Ledil F14487_FLORENCE-1R-MAXI-WG_(Rebel-ES) / LDC (Linear)

Luminaire: Ledil F14487_FLORENCE-1R-MAXI-WG_(Rebel-ES)

Lamps: 1 x Luxeon_Rebel-ES_x12_(LXML-PWC2)_1141.53lm@250mA_P=8.65W_I=0.25A

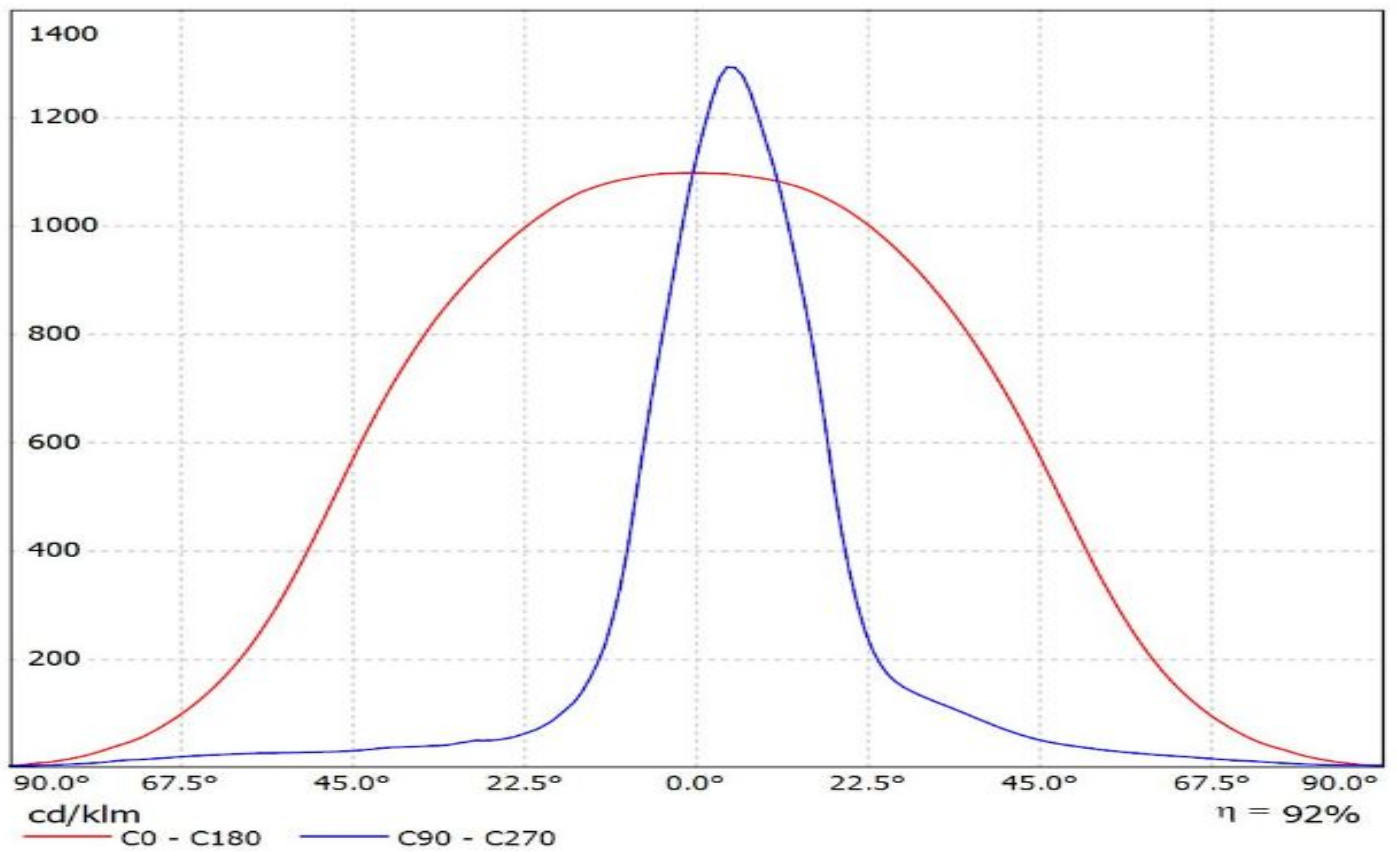

Ledil F14487_FLORENCE-1R-MAXI-WG_(Rebel) / LDC (Linear)

Luminaire: Ledil F14487_FLORENCE-1R-MAXI-WG_(Rebel)

Lamps: 1 x Luxeon_Rebel_x12_(LXM8-PW30)_763.184lm@250mA_P=8.3W_I=0.25A

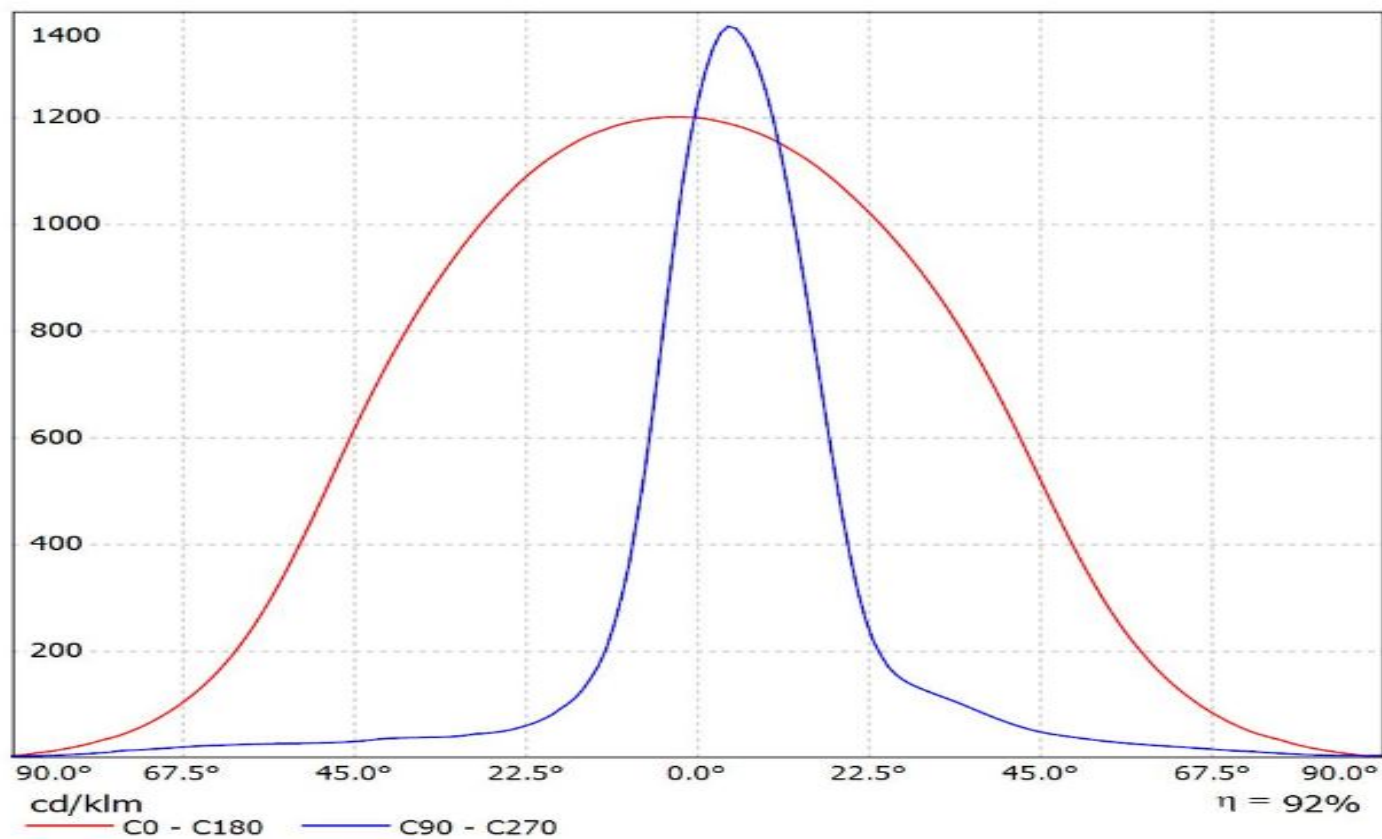

Ledil F14487_FLORENCE-1R-MAXI-WG_(Luxeon_A) / LDC (Linear)

Luminaire: Ledil F14487_FLORENCE-1R-MAXI-WG_(Luxeon_A)

Lamps: 1 x Luxeon_A_x12_(LXH8-PW30)_834.791lm@250mA_P=8.3W_I=0.25A

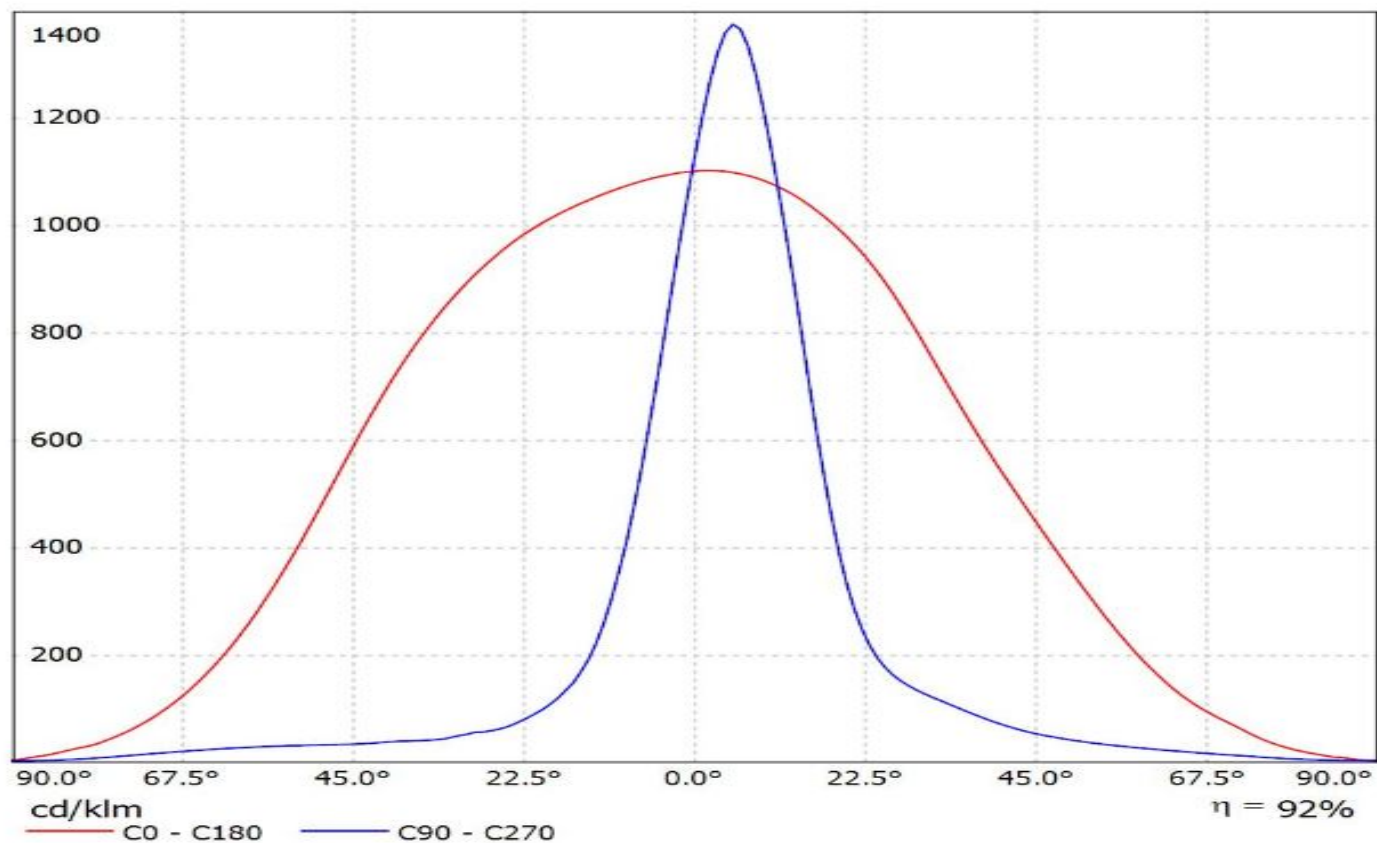

Luminaire: LEDiL Oy F14487_FLORENCE-1R-MAXI-WG_(LUXEON_Z-ES)

Lamps: 1 x LUXEON_Z-ES_(LXZ2-3080-3)_882.543lm@250mA_CCT=3000K_P=8.27363W_I=249.8mA

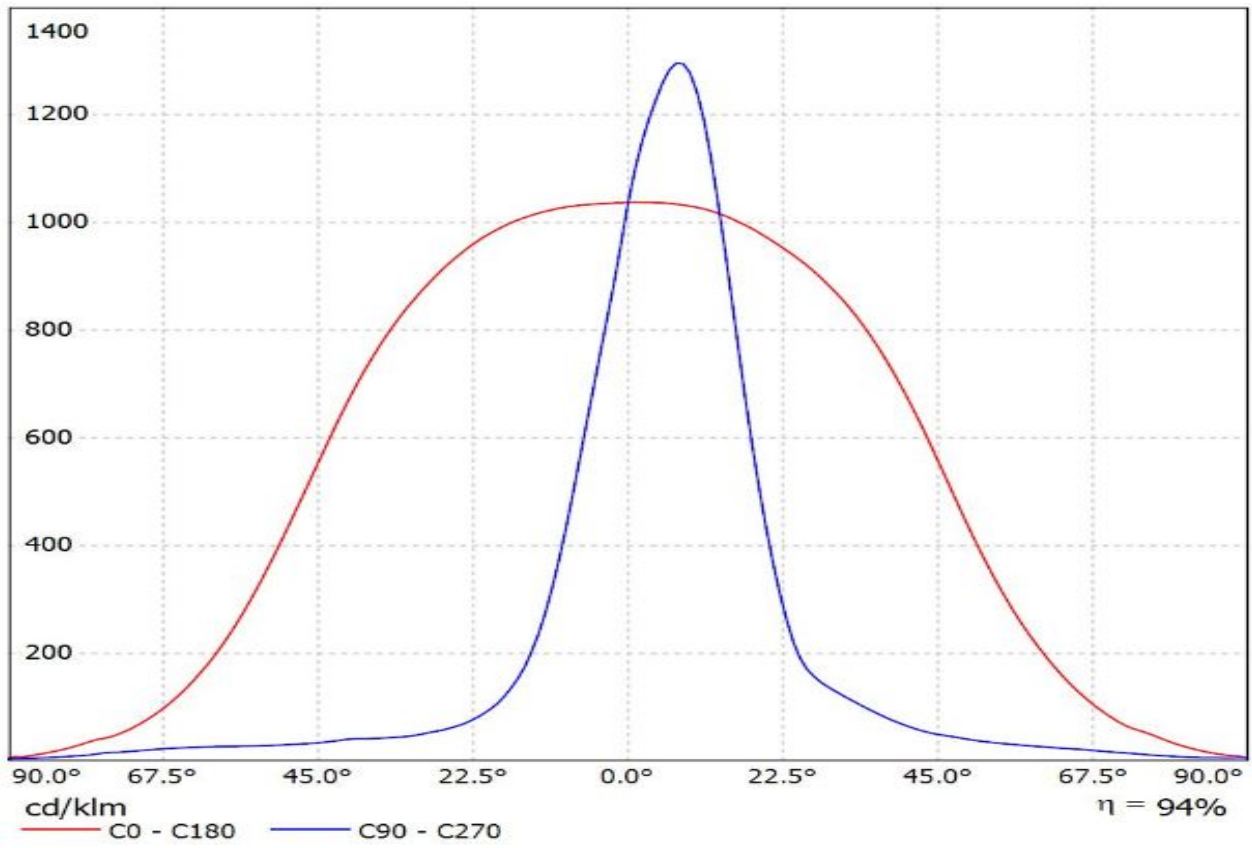

Ledil F14487_FLORENCE-1R-MAXI-WG_(Luxeon_3030_2D) / LDC (Linear)

Luminaire: Ledil F14487_FLORENCE-1R-MAXI-WG_(Luxeon_3030_2D)
Lamps: 1 x Luxeon_3030_2D_x22_(L130-4080003000W21)
_1602.96lm@200mA_CCT=4000K_P=12.8W_I=0.2A

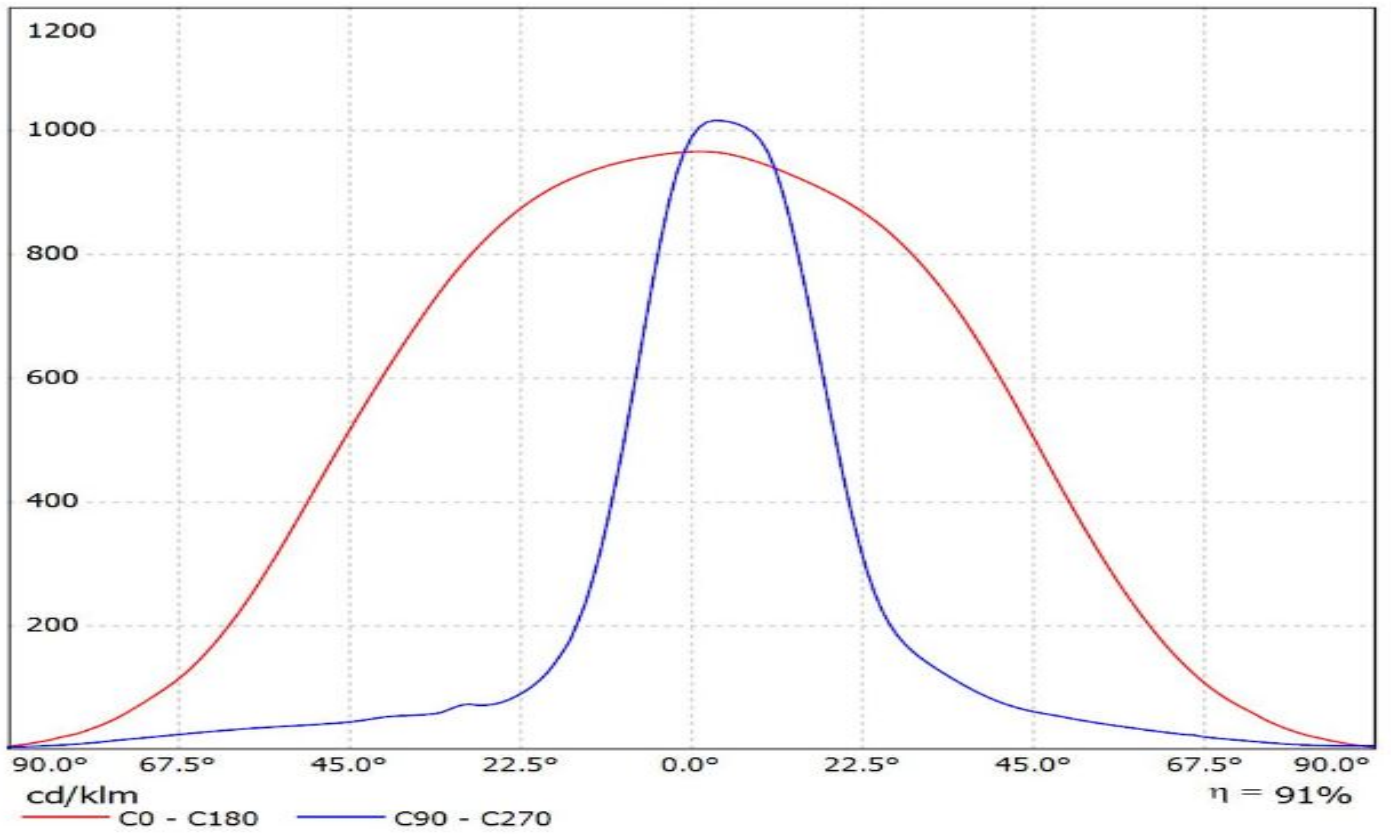

Luminaire: Ledil F14487_FLORENCE-1R-MAXI-WG_(3014_x22)

Lamps: 1 x Luxeon_3014_x22_(L130-5080)_283.51lm@60mA_P=1.9087W_I=0.060mA

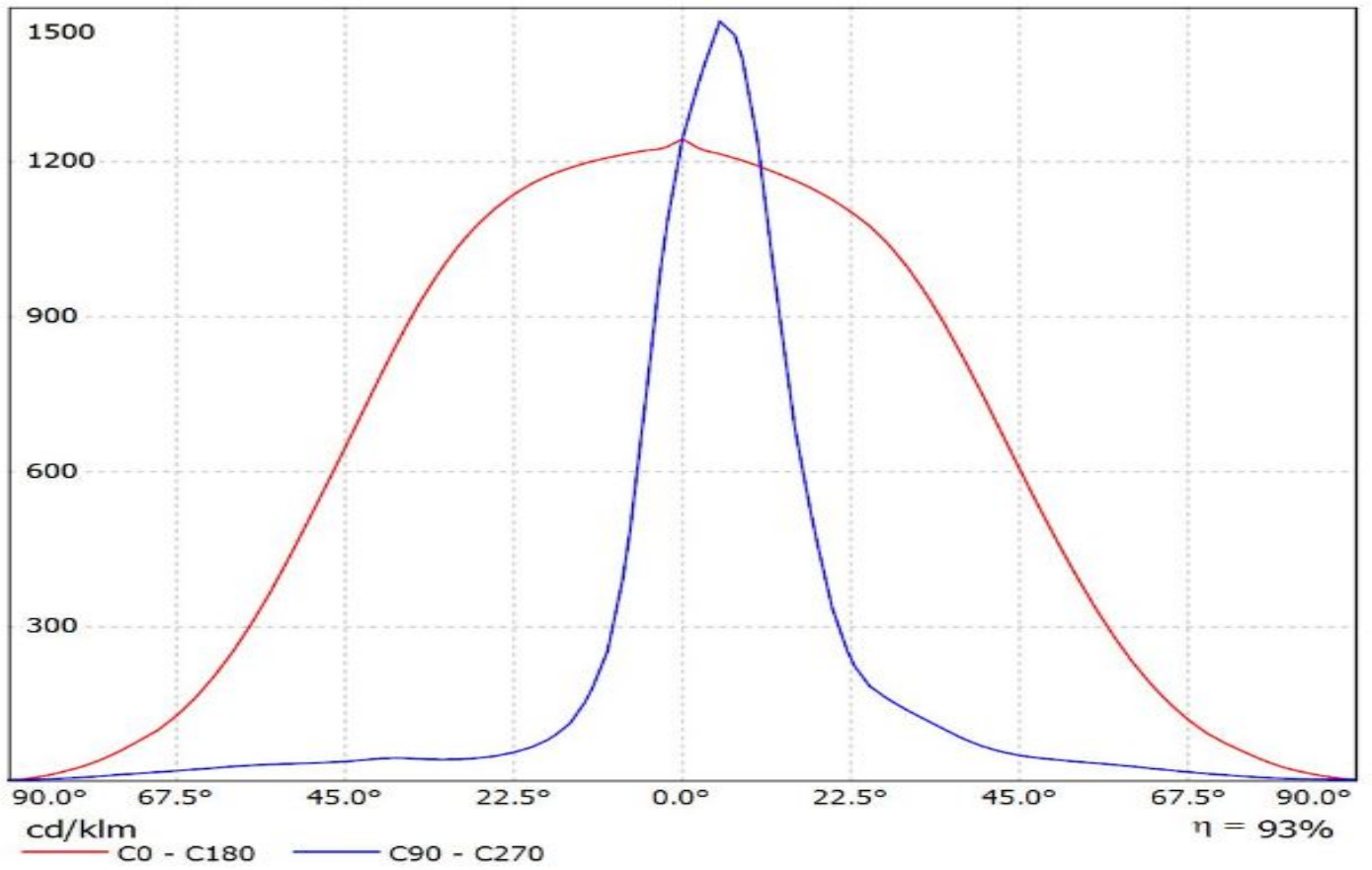

Ledil F14487_FLORENCE-1R-MAXI-WG_(NCSxx19B) / LDC (Linear)

Luminaire: Ledil F14487_FLORENCE-1R-MAXI-WG_(NCSxx19B)

Lamps: 1 x Nichia_NCSxx19B_x12_(NCSL219B)_941.258lm@250mA_P=8.9W_I=0.25A

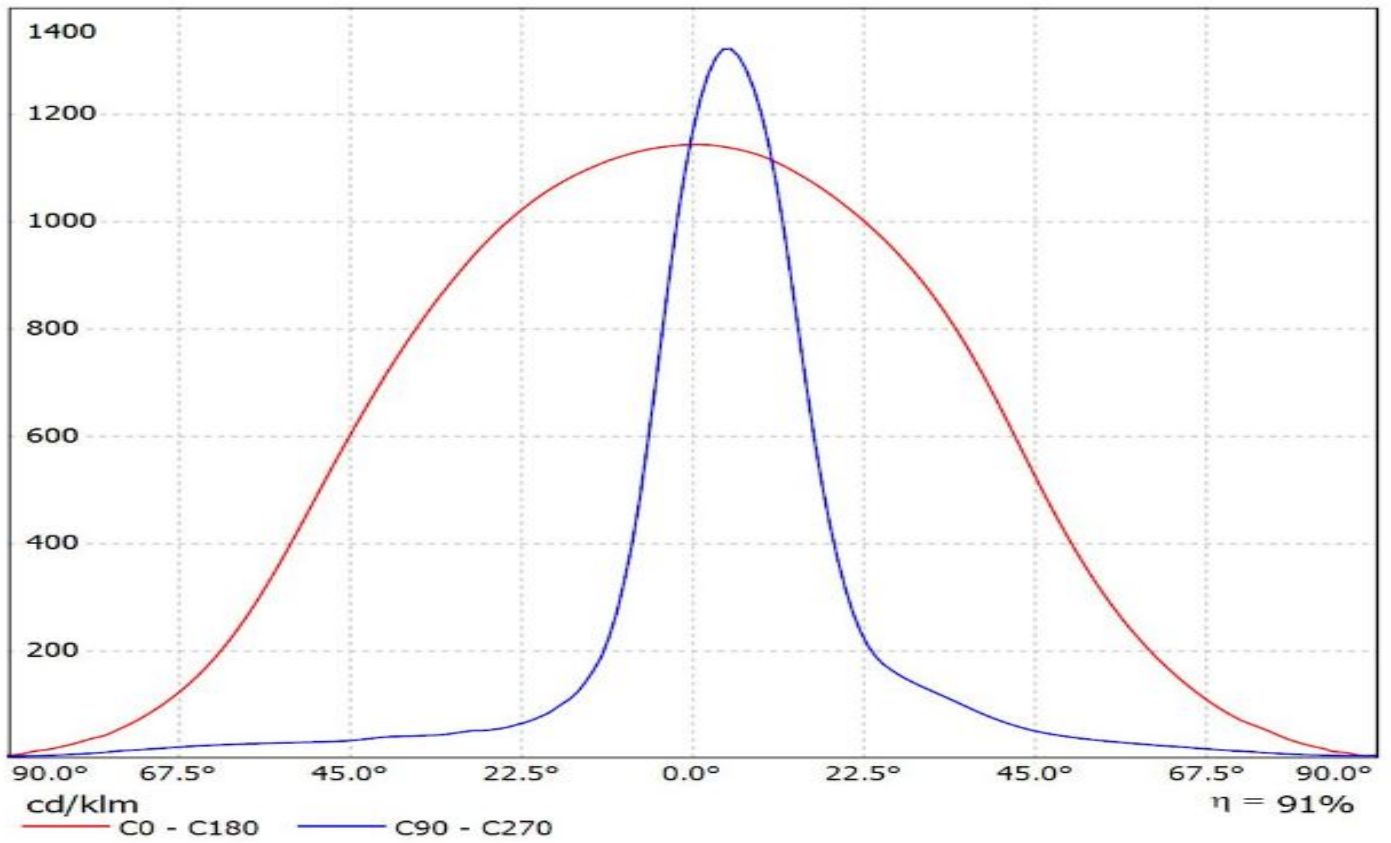

Ledil F14487_FLORENCE-1R-MAXI-WG_(NVSxx19B) / LDC (Linear)

Luminaire: Ledil F14487_FLORENCE-1R-MAXI-WG_(NVSxx19B)

Lamps: 1 x Nichia_NVSxx19B_x12_(NVSL219B)_1045.07lm@250mA_P=8.6W_I=0.25A

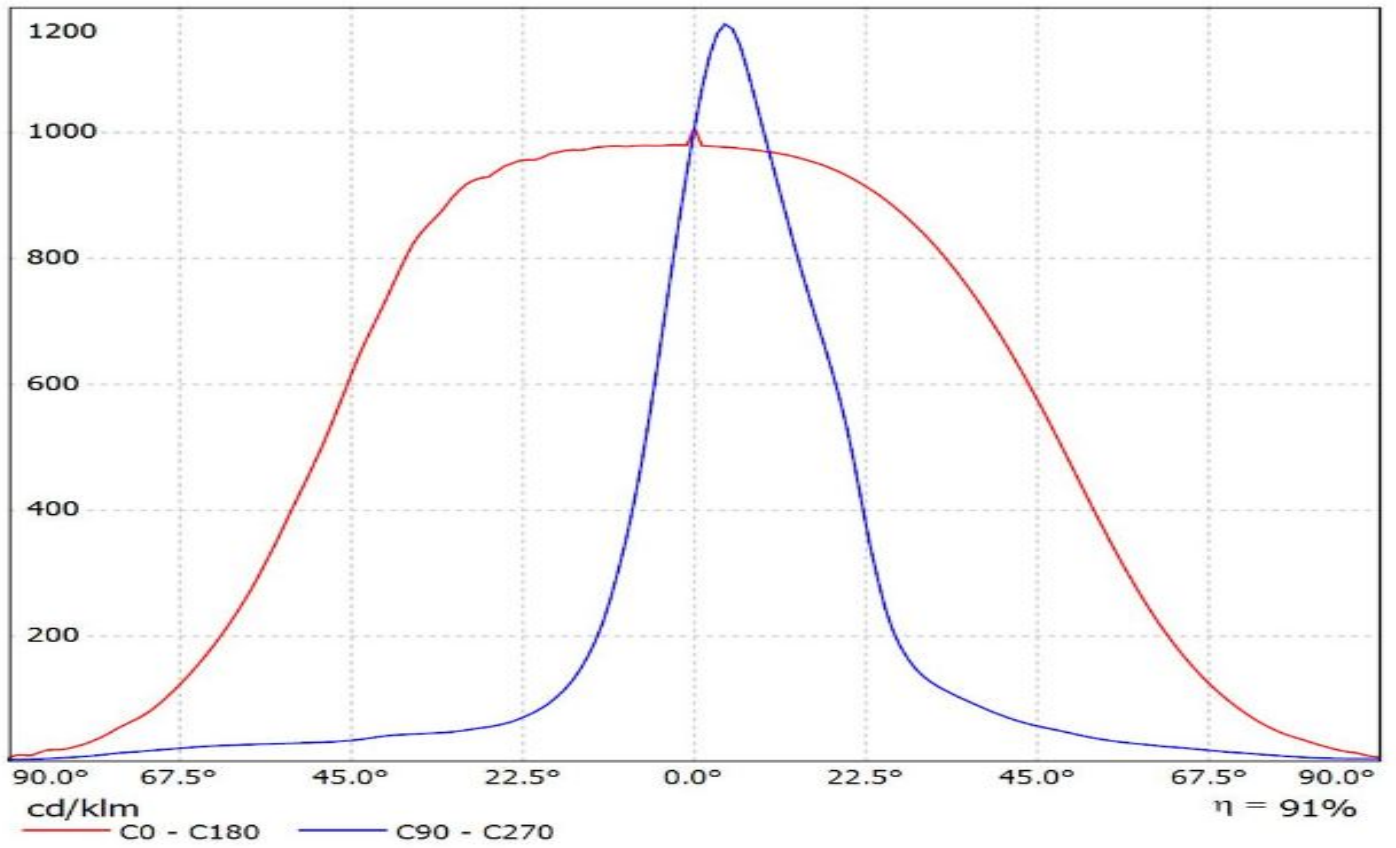

Luminaire: Ledil F14487_FLORENCE-1R-MAXI-WG_(NF2W757G)
Lamps: 1 x NF2W757G_378.284lm@65mA_CCT=?K_P=1.97W_I=0.065A

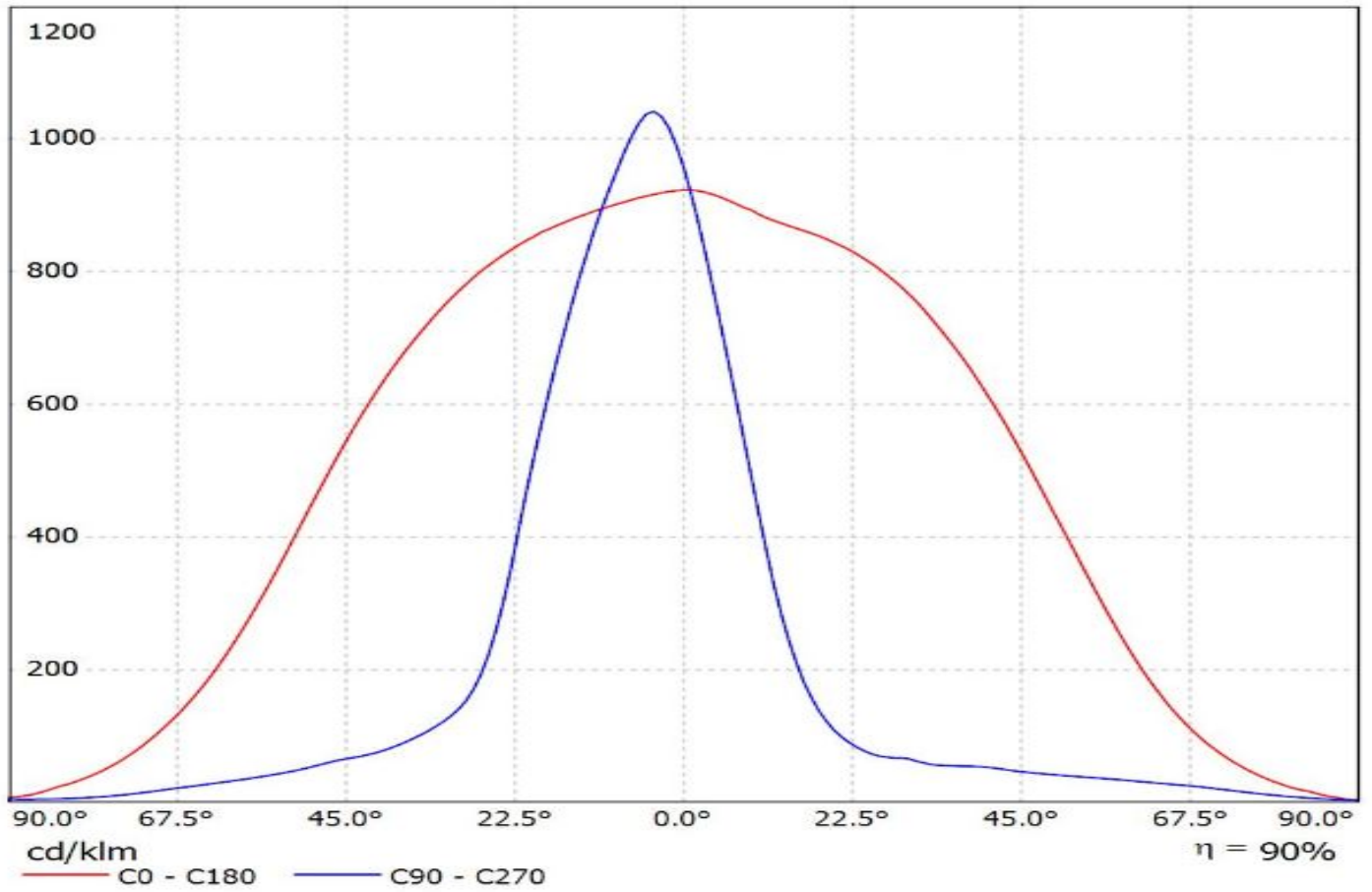

Ledil F14487_FLORENCE-1R-MAXI-WG_(Duris_S5-2chip) / LDC (Linear)

Luminaire: Ledil F14487_FLORENCE-1R-MAXI-WG_(Duris_S5-2chip)

Lamps: 1 x Osram_Duris_S5-2chip_x22_1225.67lm@150mA_P=9.55W_I=150mA

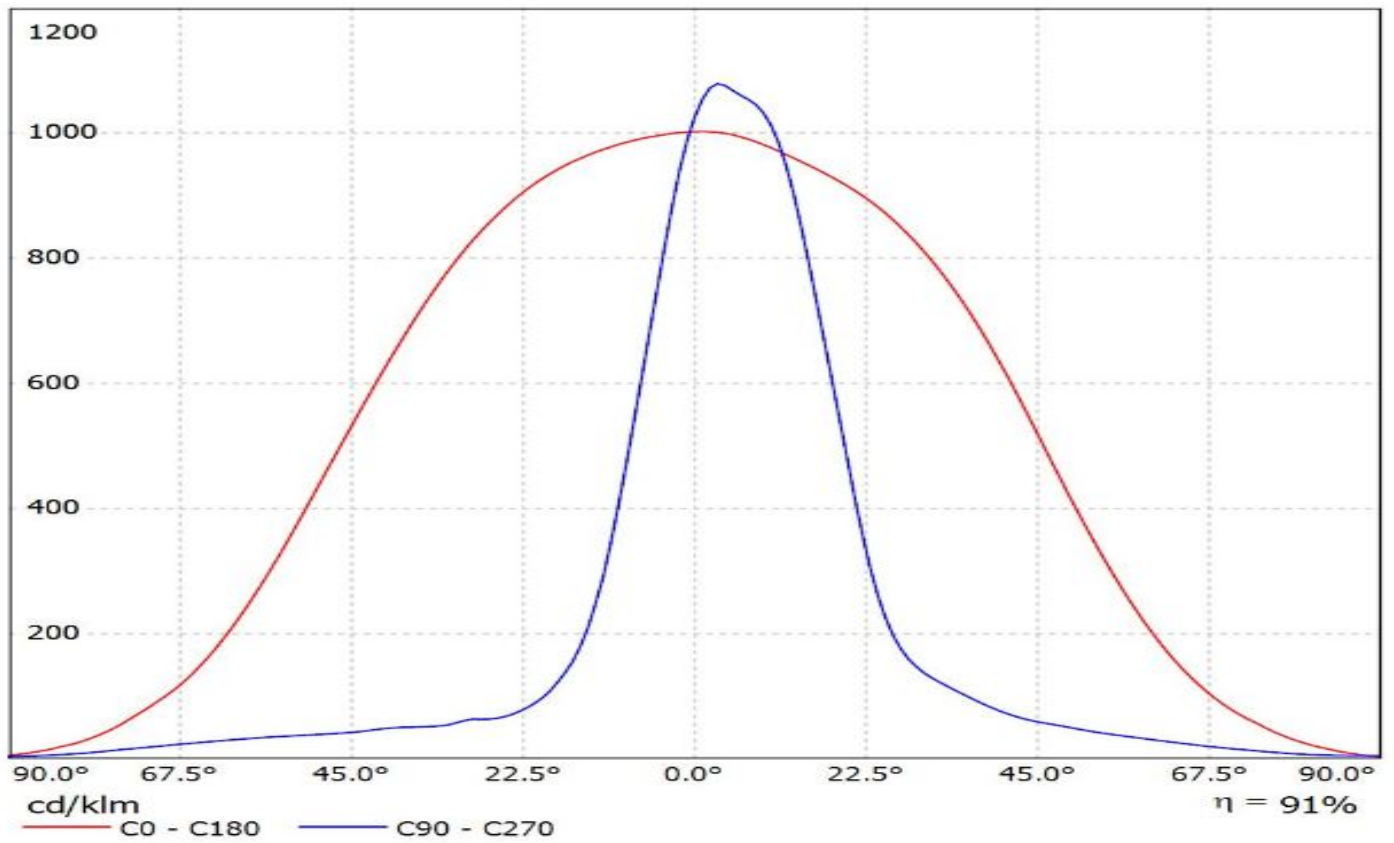

Ledil F14487_FLORENCE-1R-MAXI-WG_(SSL80) / LDC (Linear)

Luminaire: Ledil F14487_FLORENCE-1R-MAXI-WG_(SSL80)

Lamps: 1 x Osram_Oslon_SSL80_x12_(LCW_CQ7P.EC)_838.967lm@250mA_P=9.3W_I=0.25A

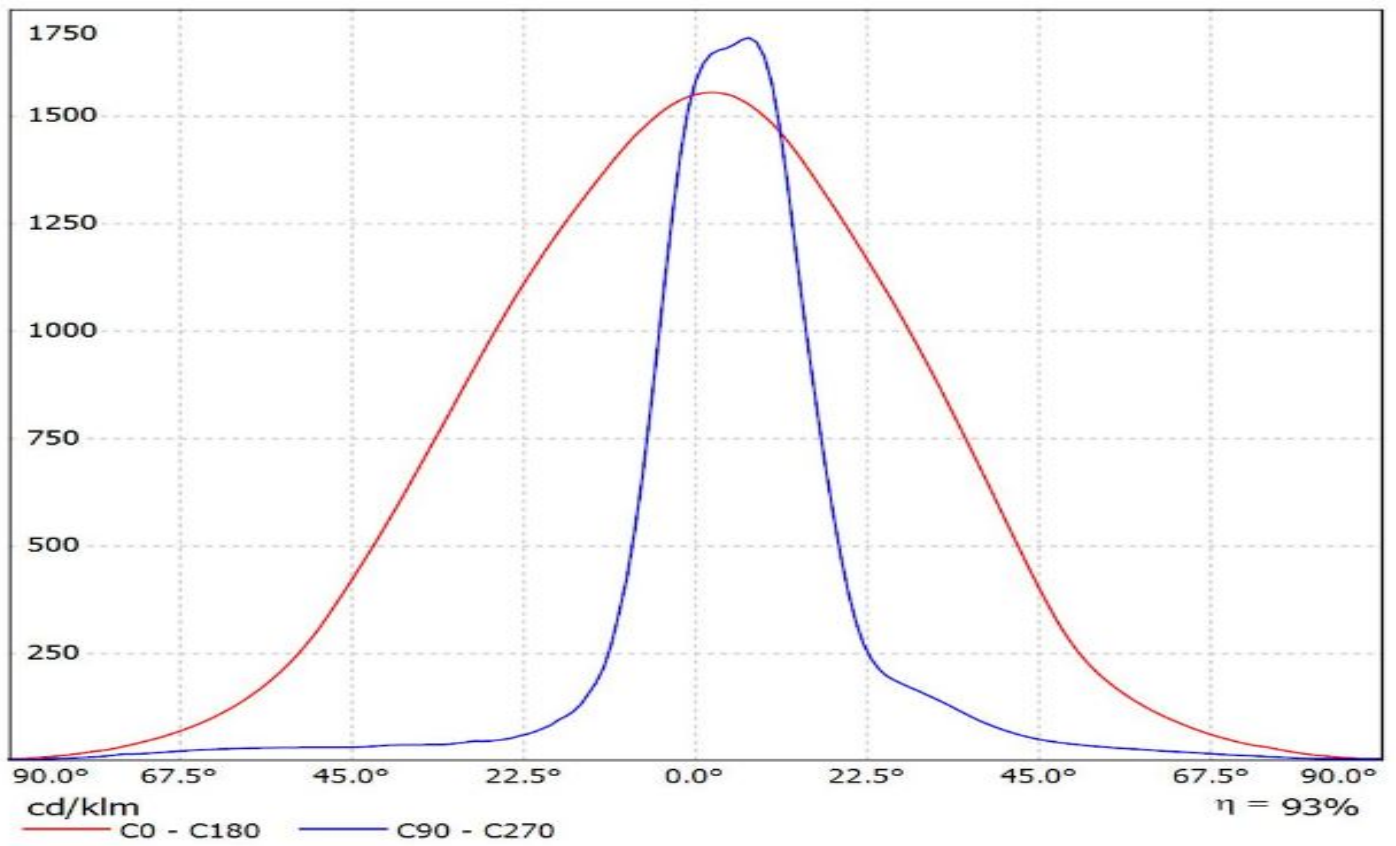

Luminaire: Ledil Oy F14487_FLORENCE-1R-MAXI-WG_(Duris_E_2835)_SIMULATED
Lamps: 1 x Osram Duris E 2835 - GW JTLRS1.EM

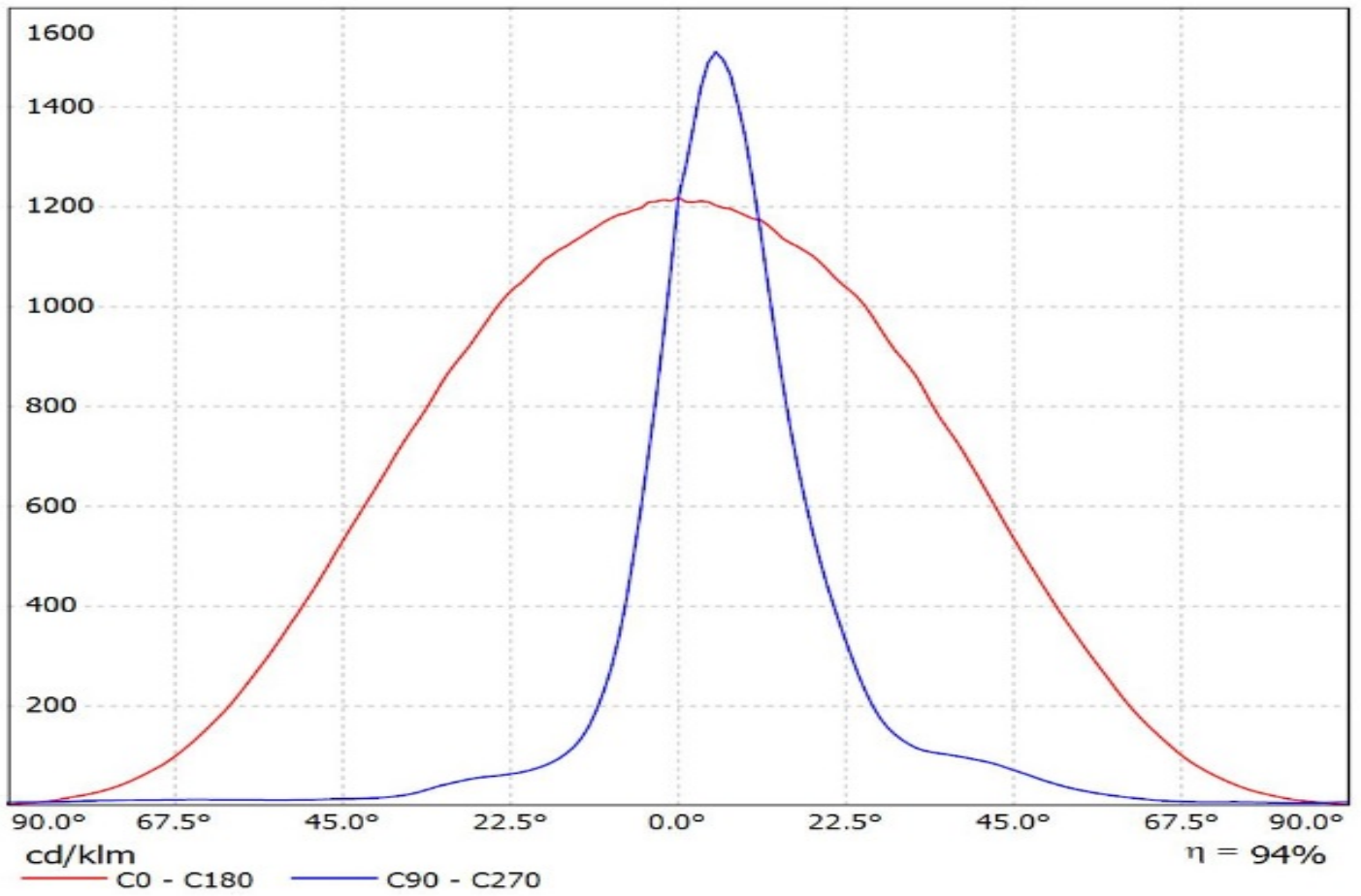

Luminaire: LEDiL Oy F14487_FLORENCE-1R-MAXI-WG_(Fortimo_LED_line_1ft_1100lm_840_1R_LV2)
Lamps: 1 x Philips_Fortimo_LED_line_1ft_1100lm_840_1R_LV2_1067.99lm@250mA_P=8.04281W_I=0.2498mA

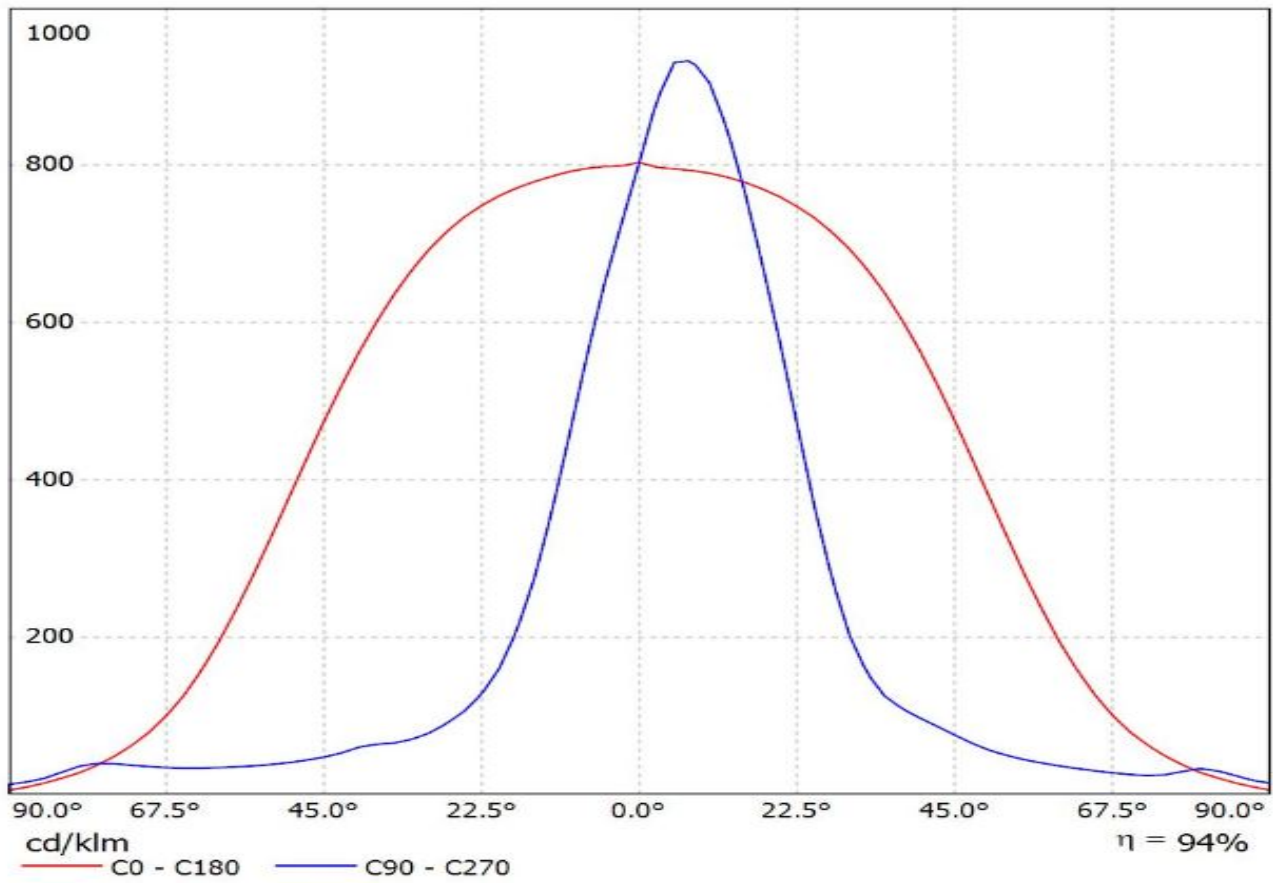

Luminaire: Ledil F14487_FLORENCE-1R-MAXI-WG_(LT-S282N)

Lamps: 1 x Samsung SI-B8T071280LD_LM5618+_1401.55lm@250mA_P=9.185W_I=0.25A

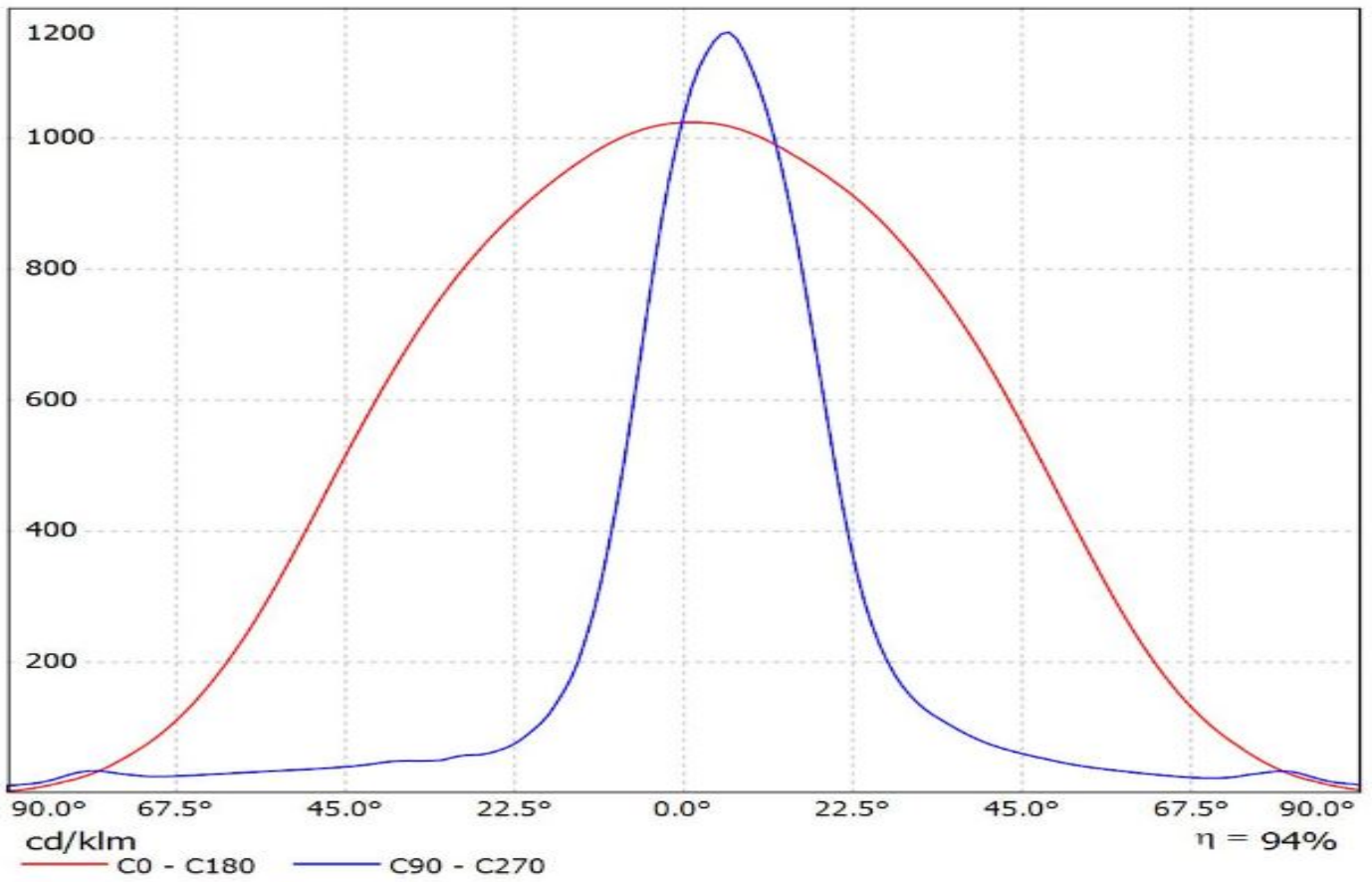

Luminaire: Ledil F14487_FLORENCE-1R-MAXI-WG_(LM301A)

Lamps: 1 x Samsung_LM301A_x11_(SPMWHT328FD5WAT0S0)_1107.77lm@250mA_P=8.1W_I=0.25A

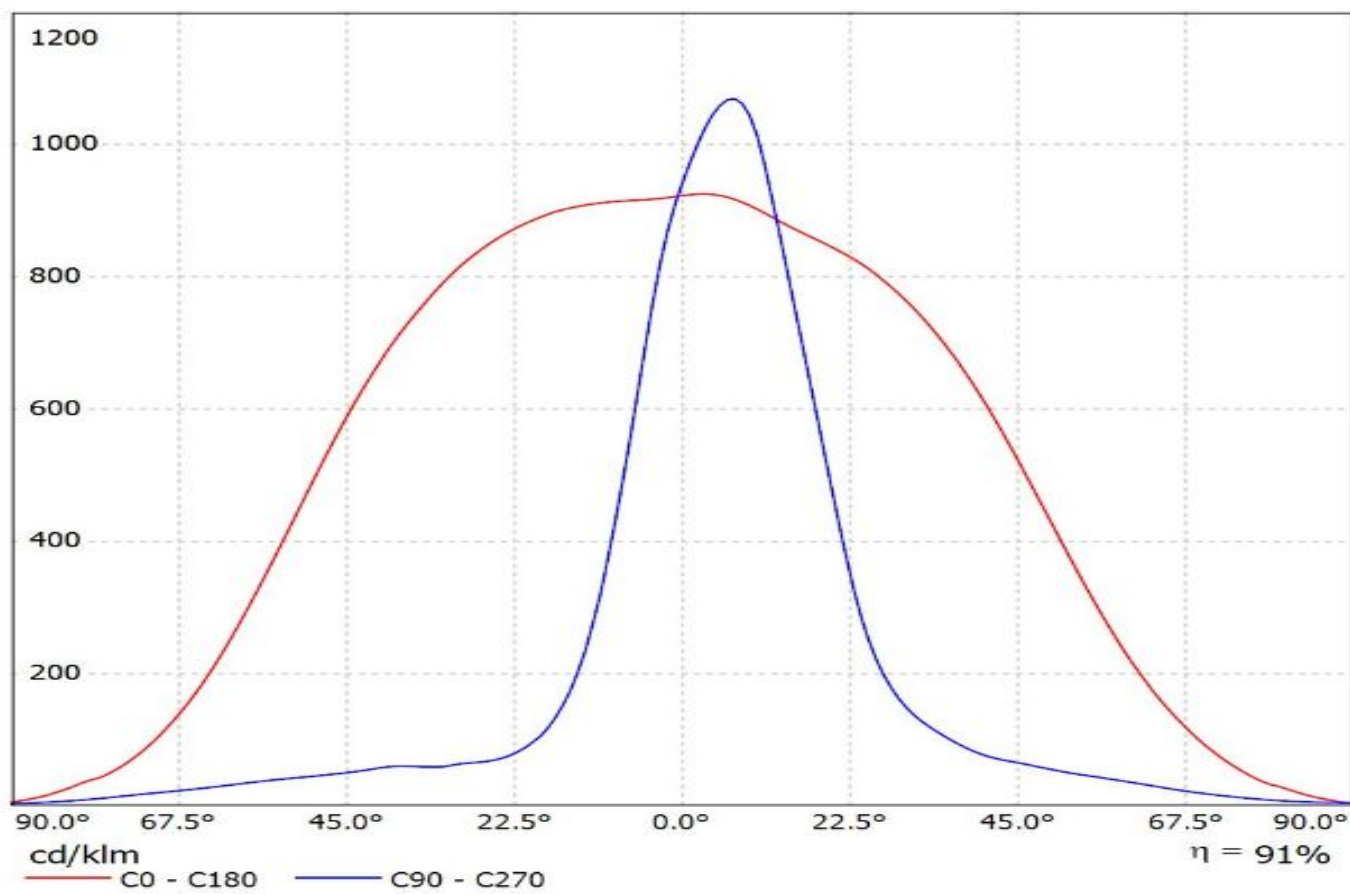

Luminaire: LEDiL Oy F14487_FLORENCE-1R-MAXI-WG_(LM561C)
Lamps: 1 x Samsung_LM561C_685.154lm@130mA_P=3.9367W_I=0.130A

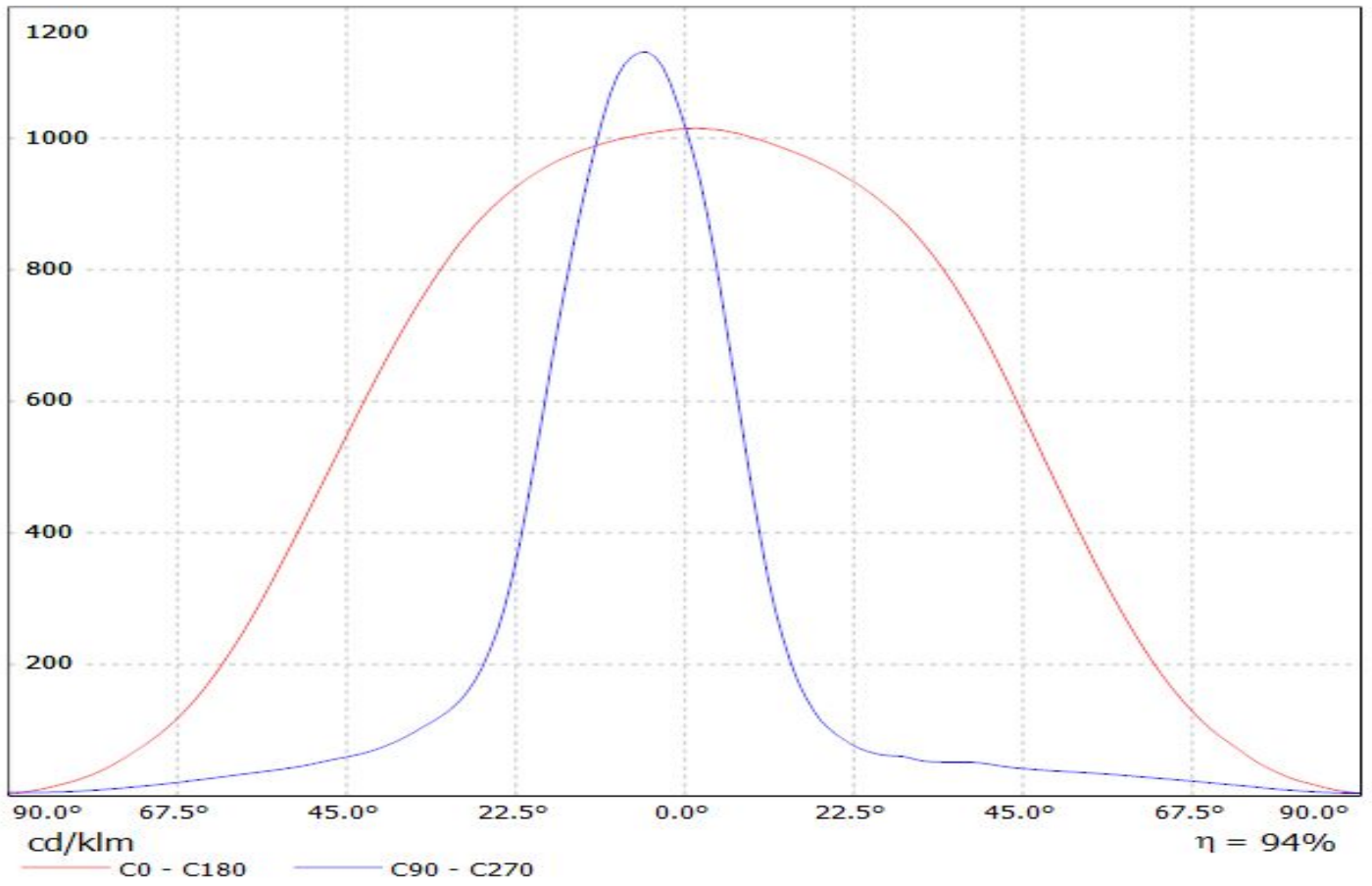

Luminaire: LEDiL Oy F14487_FLORENCE-1R-MAXI-WG_(LM281B)
Lamps: 1 x Samsung_LM281B_1309.14lm@300mA_P=10.244W_I=0.300A

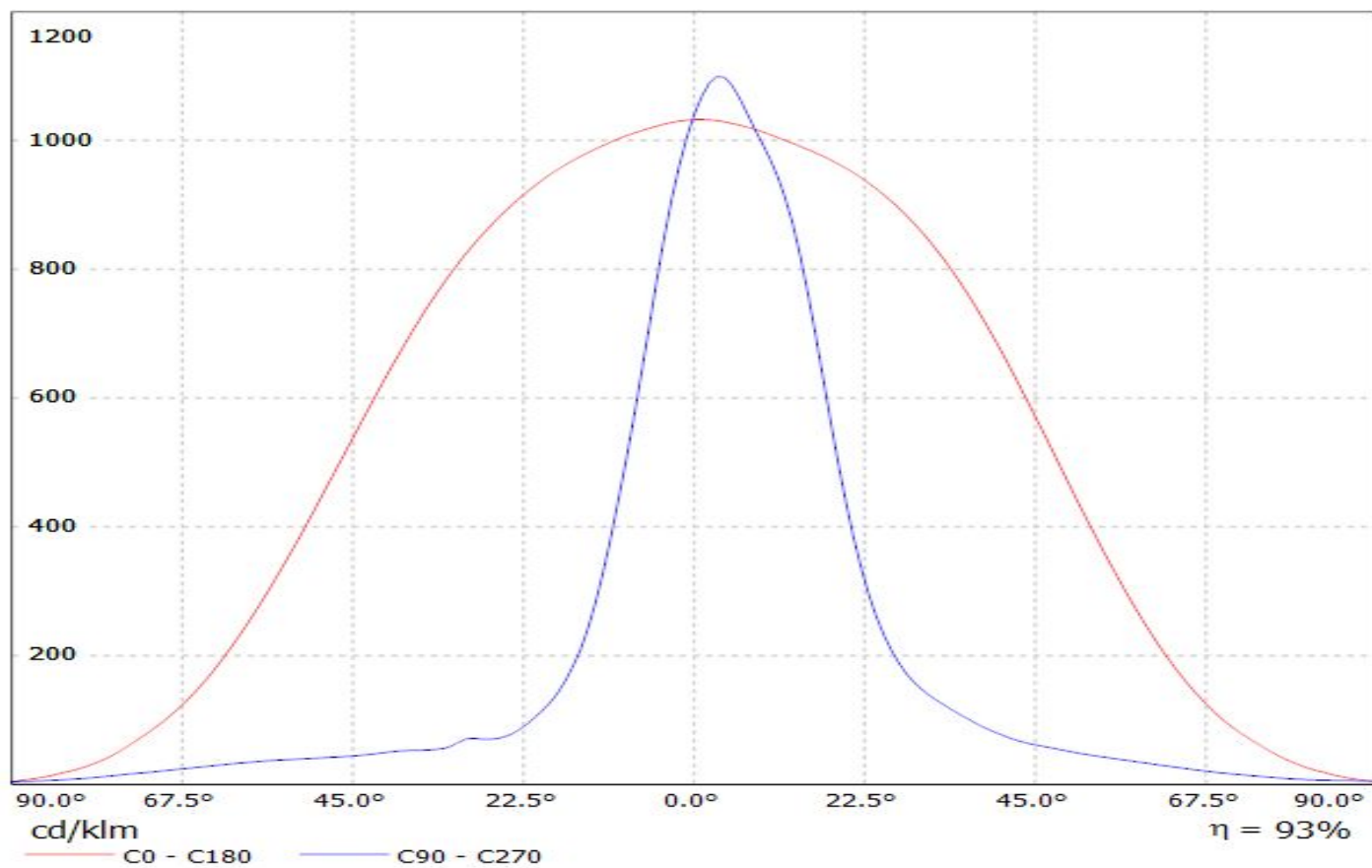

Luminaire: Ledil F14487_FLORENCE-1R-MAXI-WG_(CALGD0414-M8W1)
Lamps: 1 x Citizen_(CALGD0414-M8W1)_556.672lm@350mA_P=4.0291W_I=0.3499A

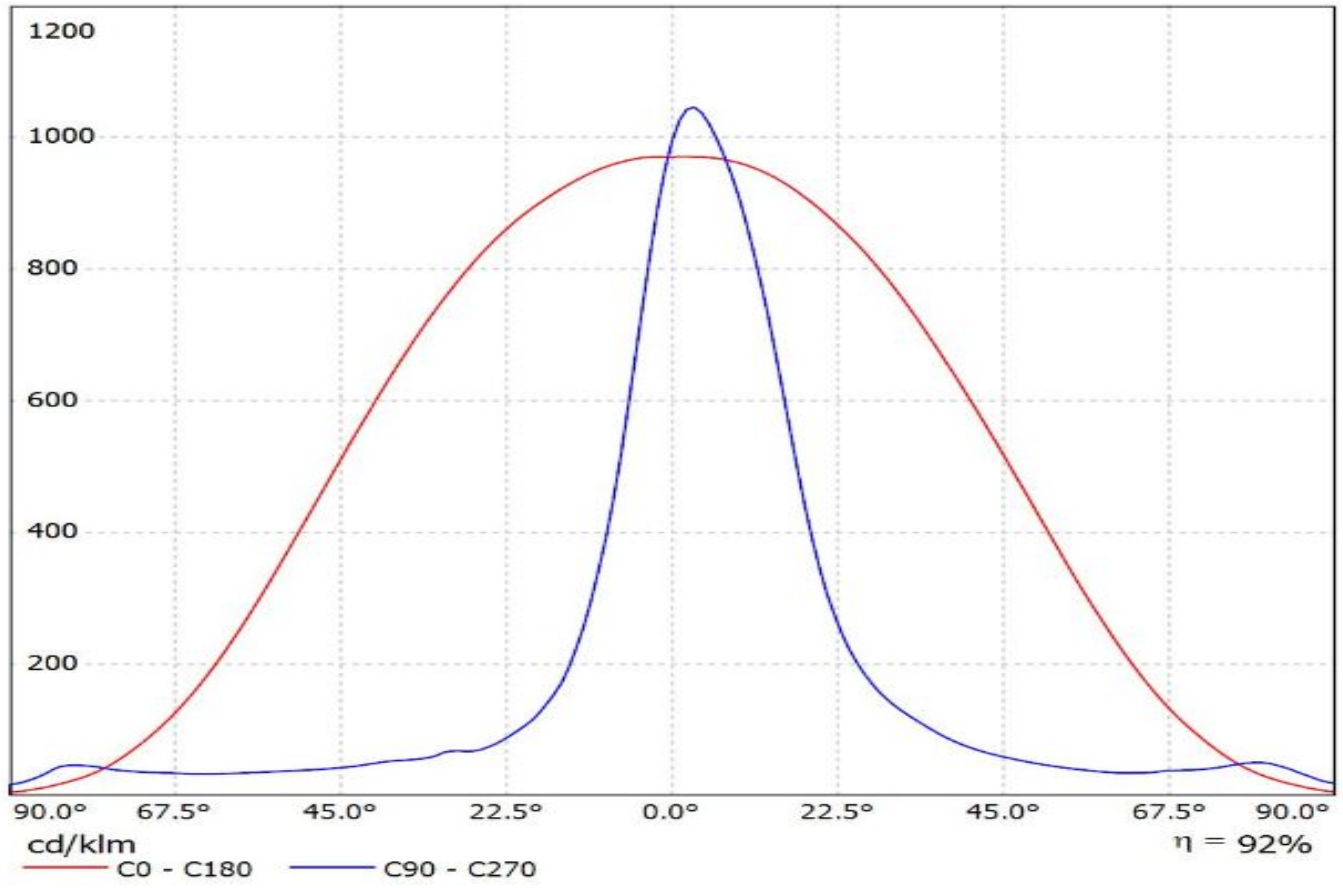

Luminaire: Ledil F14487_FLORENCE-1R-MAXI-WG_(CALGD0814-M17W1)
Lamps: 1 x CALGD0814-M17W1_1094.82lm@350mA_P=7.9555W_I=0.35A

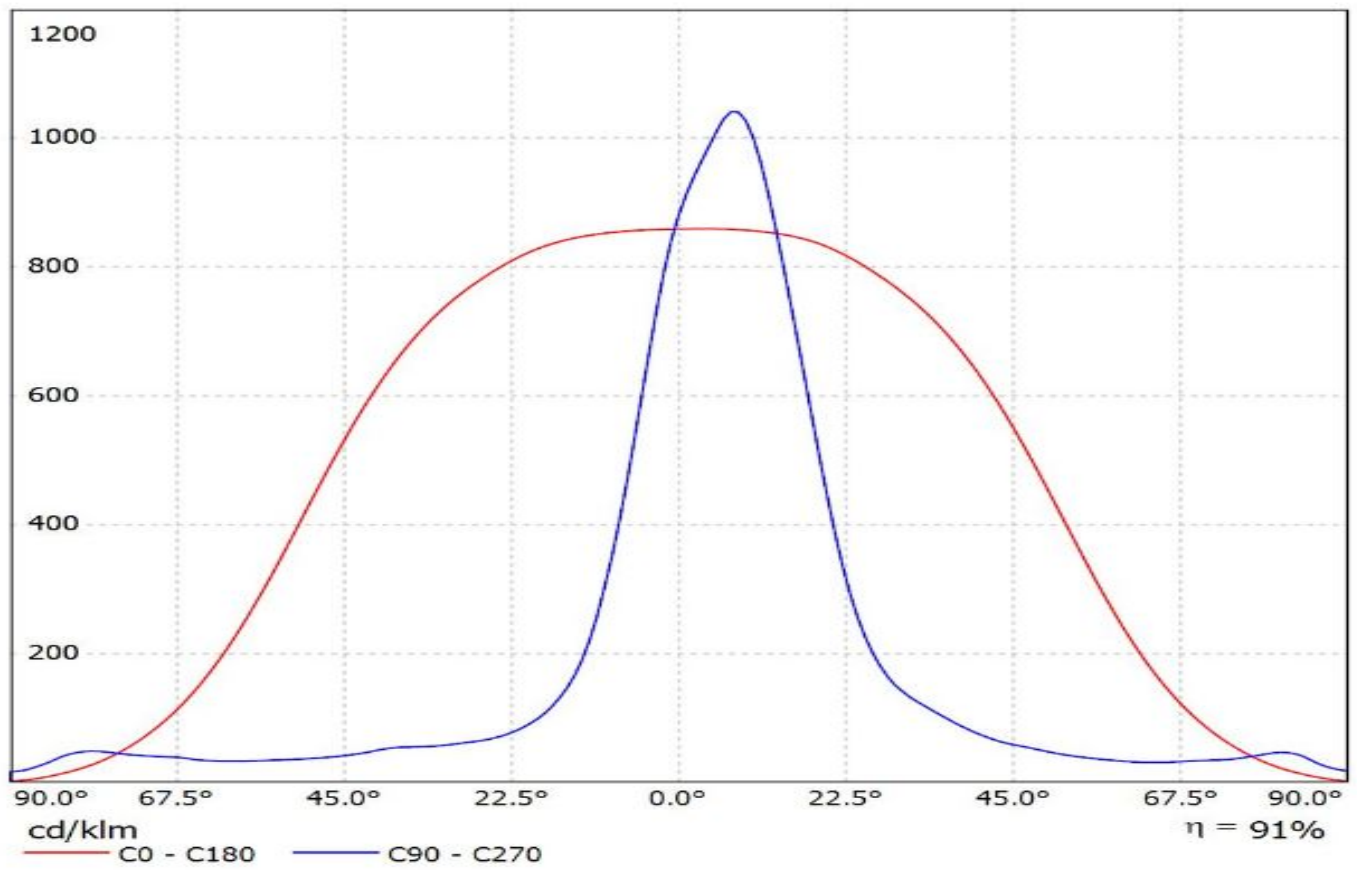

Luminaire: Ledil F14487_FLORENCE-1R-MAXI-WG_(CeZos)

Lamps: 1 x CeZos_(L0-280024-xxx-C0800-L267)_1346.29lm@250mA_CCT=3000K_P=8.5017W_I=0.25A

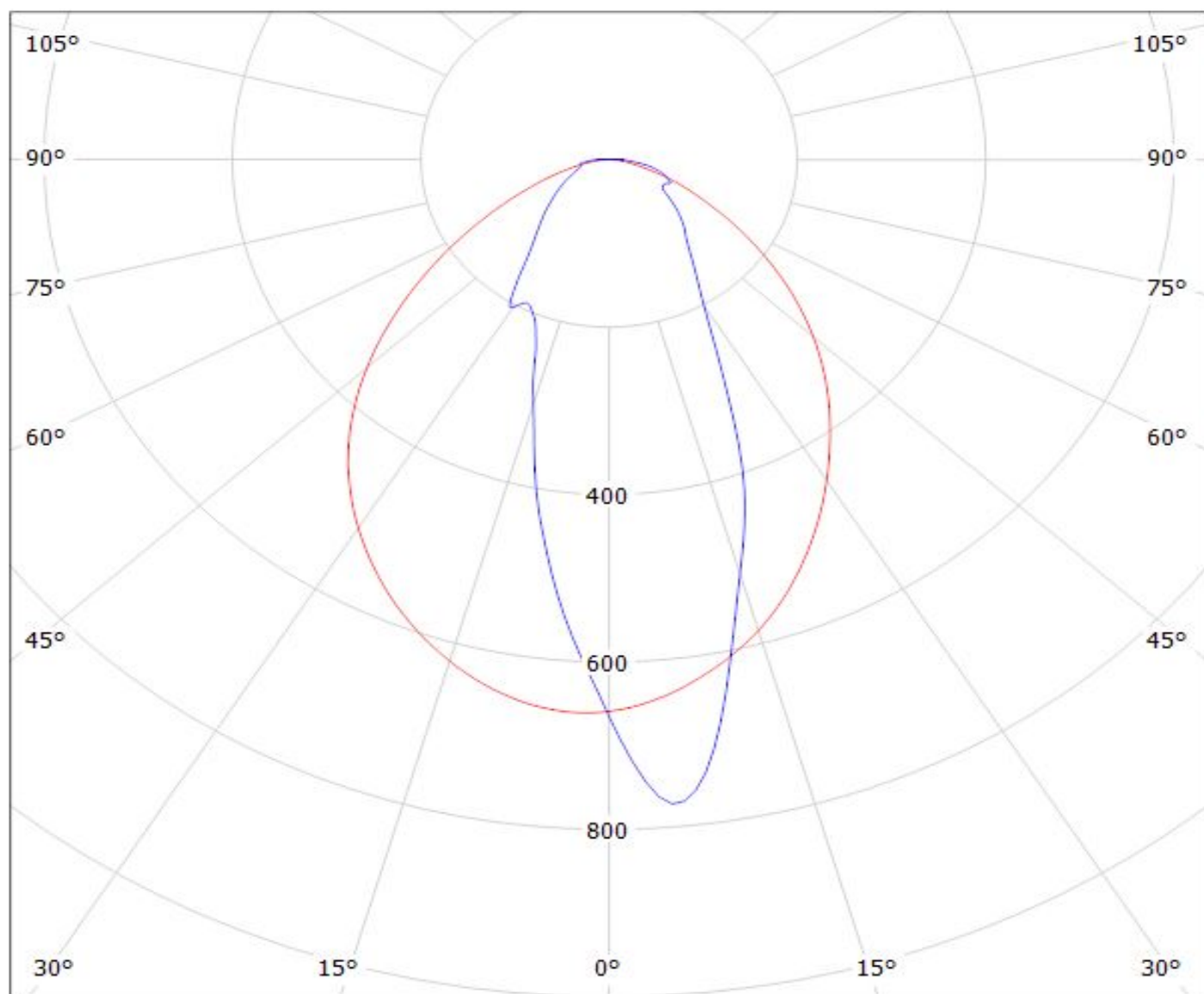

cd/klm

— C0 - C180 — C90 - C270

$\eta = 90\%$

Ledil F14487_FLORENCE-1R-MAXI-WG_(XP-G) / LDC (Polar)

Luminaire: Ledil F14487_FLORENCE-1R-MAXI-WG_(XP-G)

Lamps: 1 x Cree_XP-G_x12_(XPGWHT-L1-CWPI-00BE7)_795.108lm@250mA_P=8.6W_I=0.25A

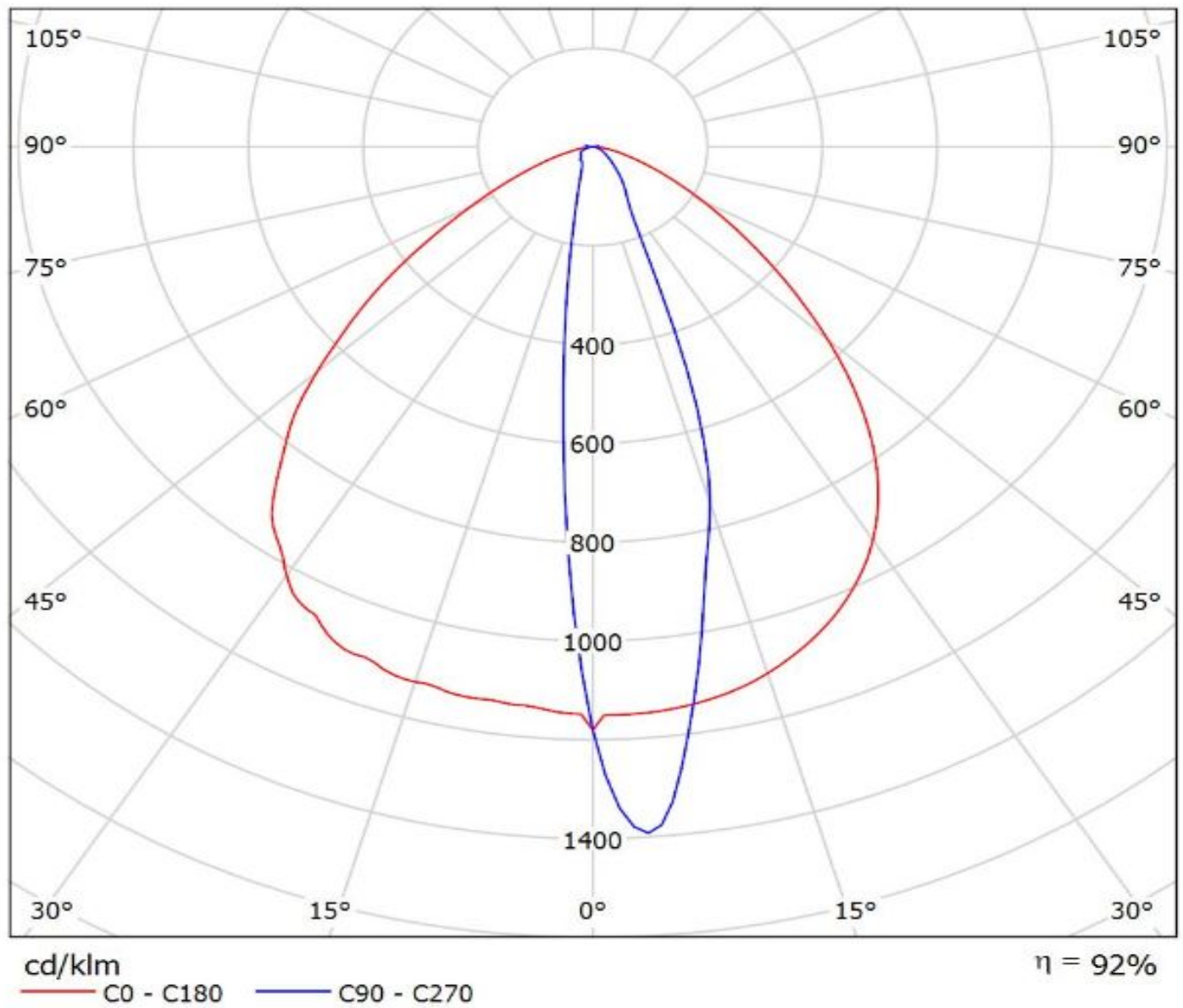

Luminaire: LEDiL Oy F14487_FLORENCE-1R-MAXI-WG_(XP-E2)_2

Lamps: 1 x (XP-E2_florence)_881.969lm@250mA_P=8.62385W_I=0.2498mA

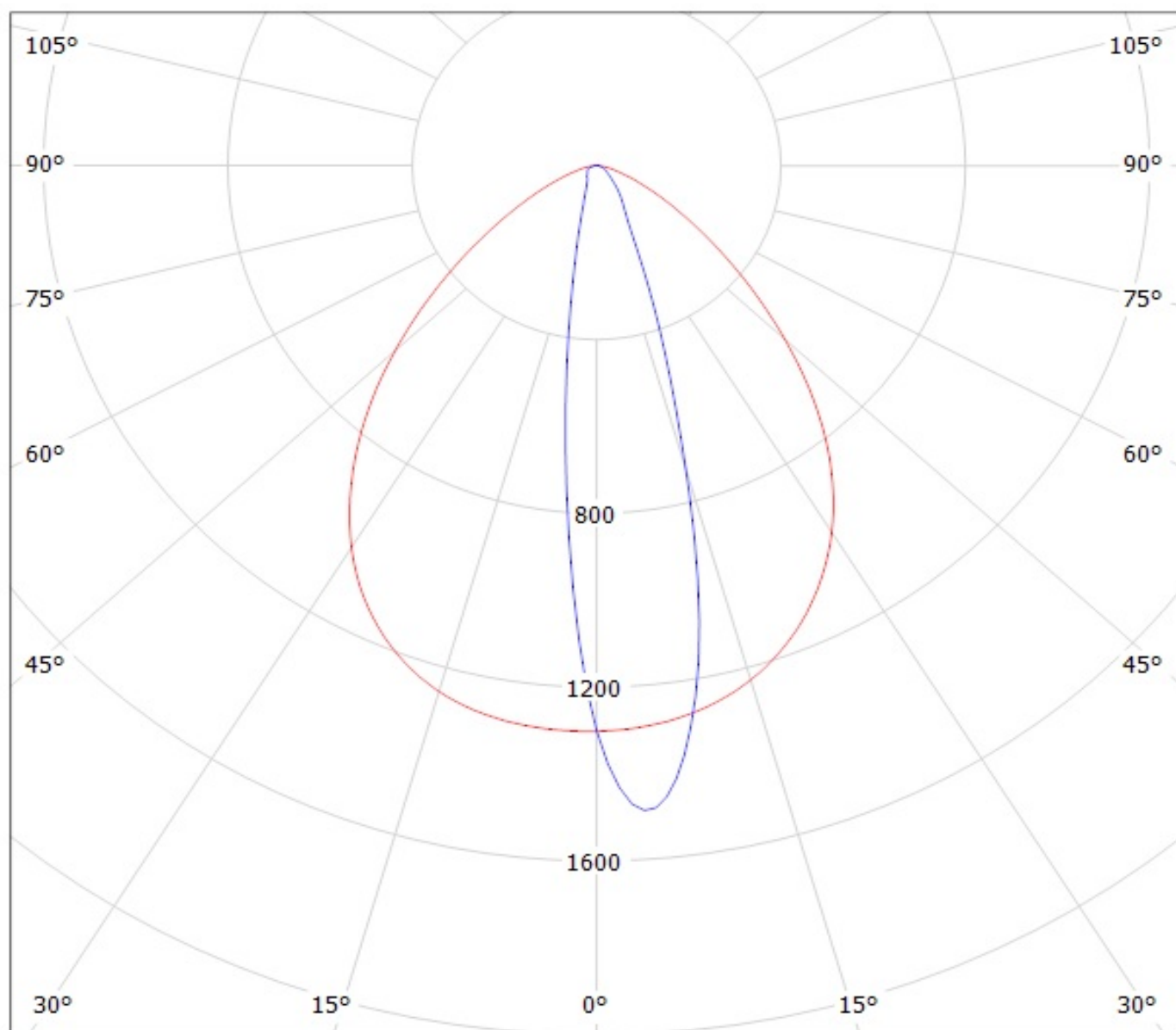

cd/klm

— C0 - C180 — C90 - C270

$\eta = 95\%$

Ledil F14487_FLORENCE-1R-MAXI-WG_(XP-E) / LDC (Polar)

Luminaire: Ledil F14487_FLORENCE-1R-MAXI-WG_(XP-E)

Lamps: 1 x Cree_XP-E_x12_(XPEWHT-L1-3C0-Q5-0-06)_941.258lm@250mA_P=9W_I=0.25A

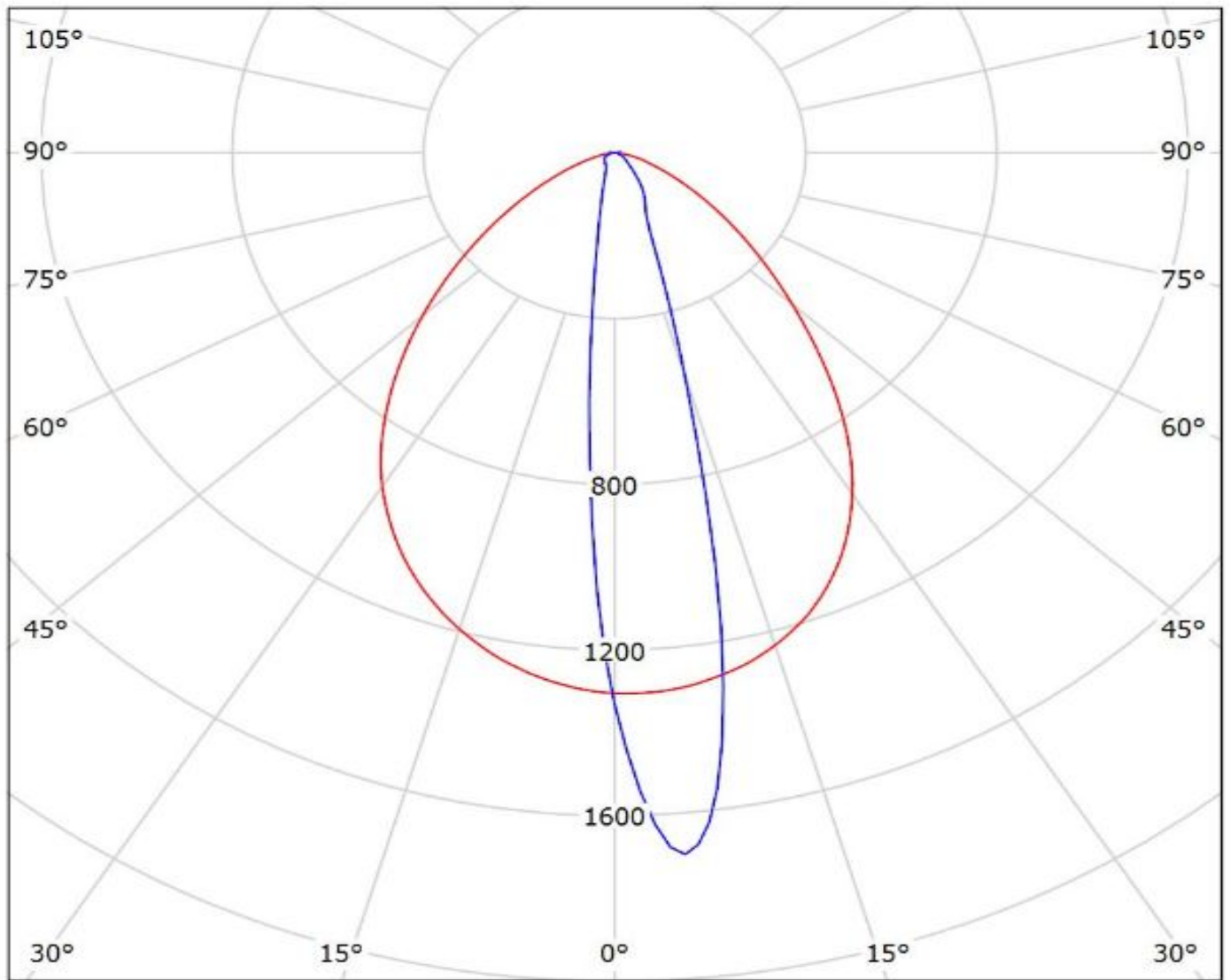

cd/klm

— C0 - C180 — C90 - C270

$\eta = 91\%$

Luminaire: LEDiL Oy F14487_FLORENCE-1R-MAXI-WG_(XQ-E)

Lamps: 1 x CREE_XQ-E_(XQEAWT-0-7B1-Q40-0H-00001)_872.003lm@250mA_P=8.58163W_I=249.8mA

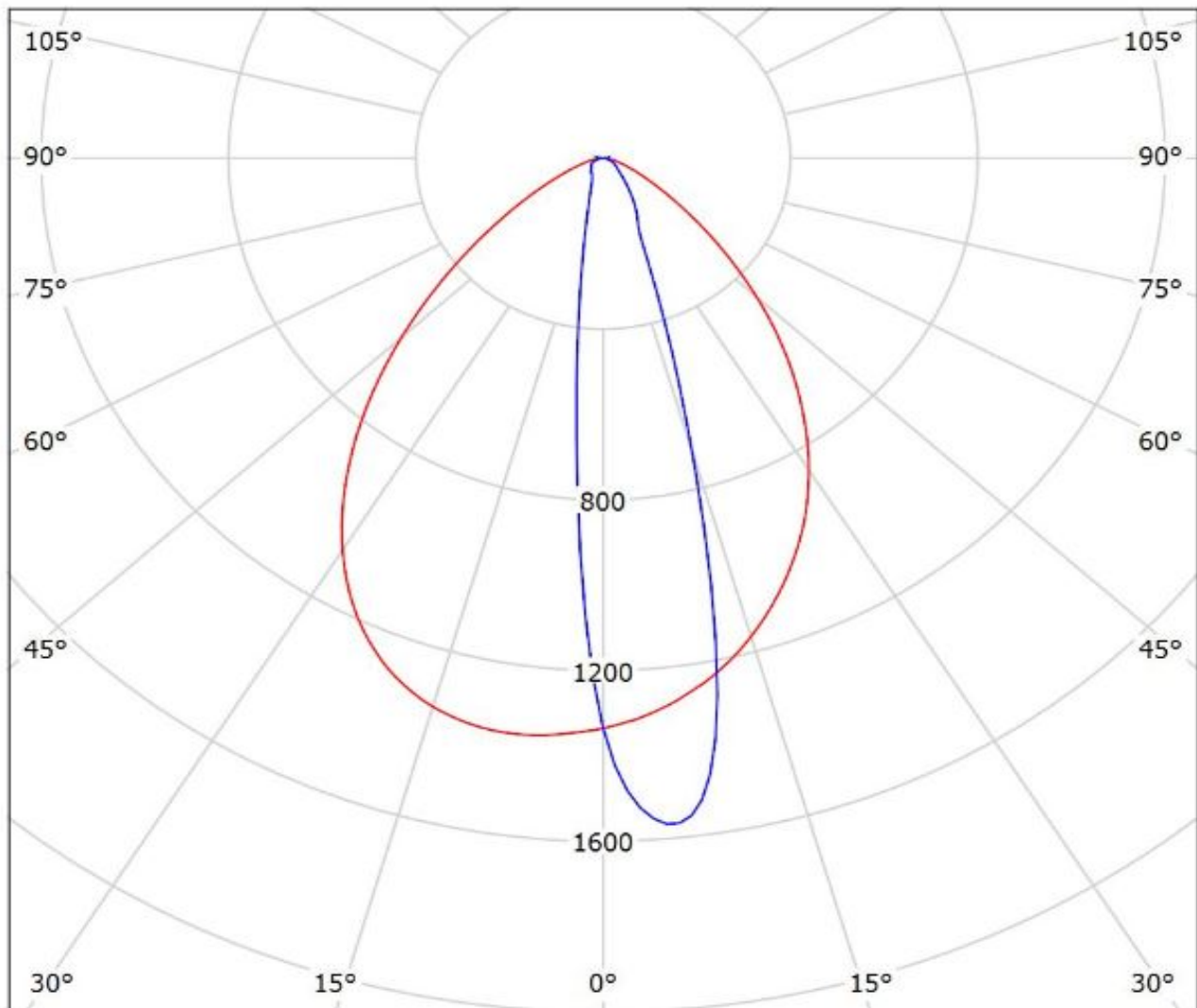

cd/klm

— C0 - C180 — C90 - C270

$\eta = 95\%$

Ledil F14487_FLORENCE-1R-MAXI-WG_(XP-G2) / LDC (Polar)

Luminaire: Ledil F14487_FLORENCE-1R-MAXI-WG_(XP-G2)

Lamps: 1 x Cree_XP-G2_x12_(XPGBWT-01-4A0-R3-0-01)_1206.16lm@250mA_P=8.5W_η=0.25A

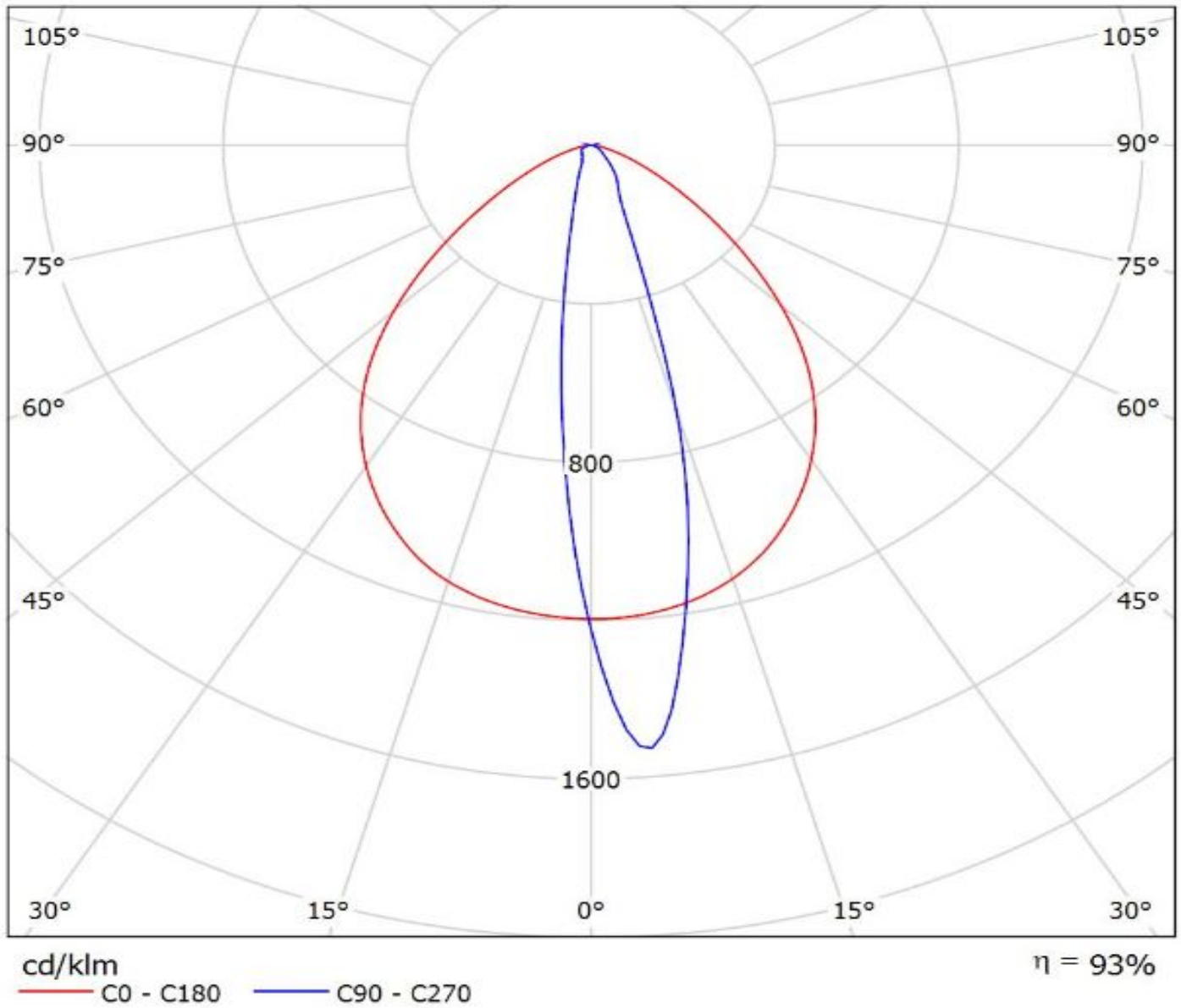

Ledil F14487_FLORENCE-1R-MAXI-WG_(Rebel-ES) / LDC (Polar)

Luminaire: Ledil F14487_FLORENCE-1R-MAXI-WG_(Rebel-ES)

Lamps: 1 x Luxeon_Rebel-ES_x12_(LXML-PWC2)_1141.53lm@250mA_P=8.65W_I=0.25A

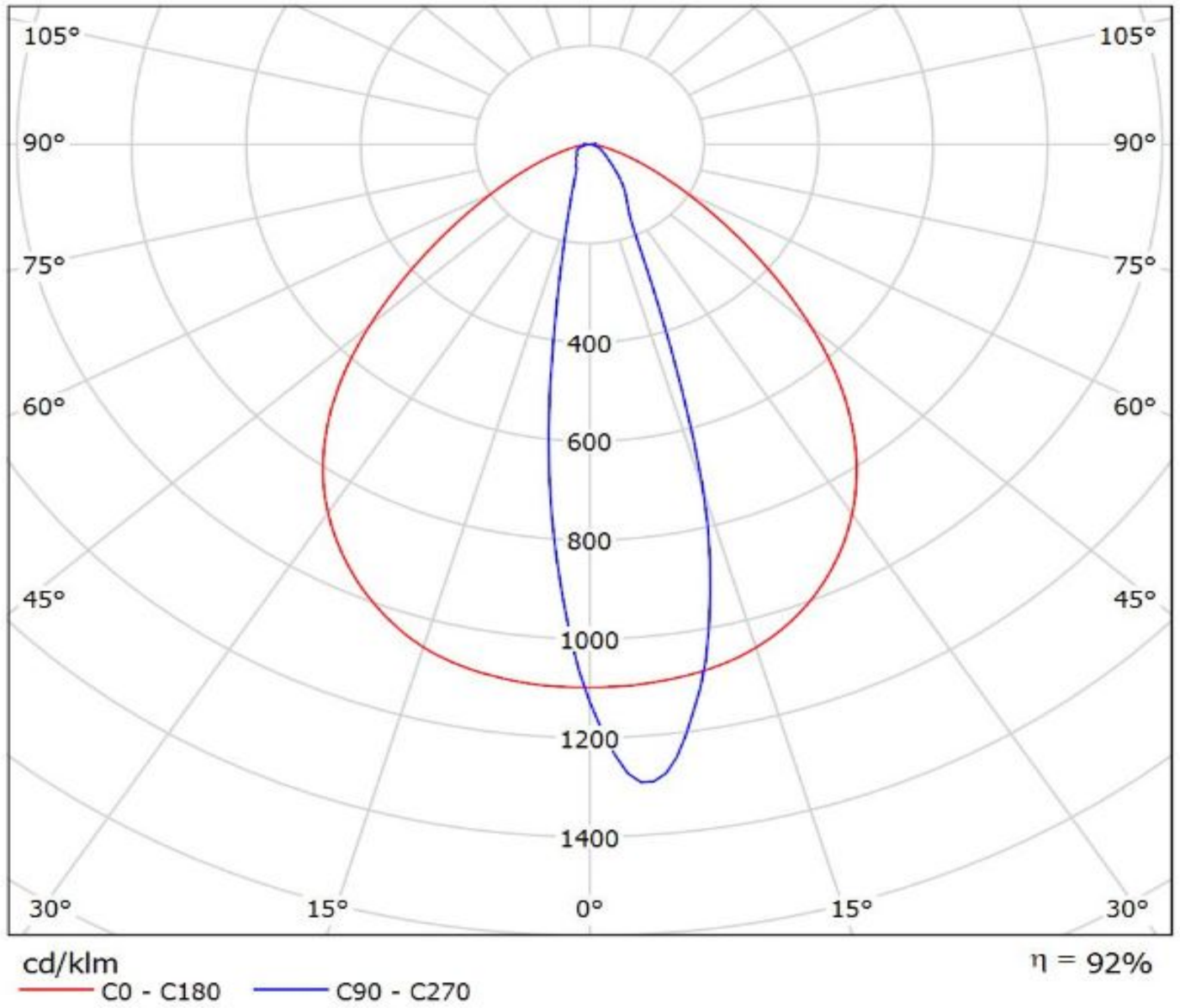

Ledil F14487_FLORENCE-1R-MAXI-WG_(Rebel) / LDC (Polar)

Luminaire: Ledil F14487_FLORENCE-1R-MAXI-WG_(Rebel)

Lamps: 1 x Luxeon_Rebel_x12_(LXM8-PW30)_763.184lm@250mA_P=8.3W_I=0.25A

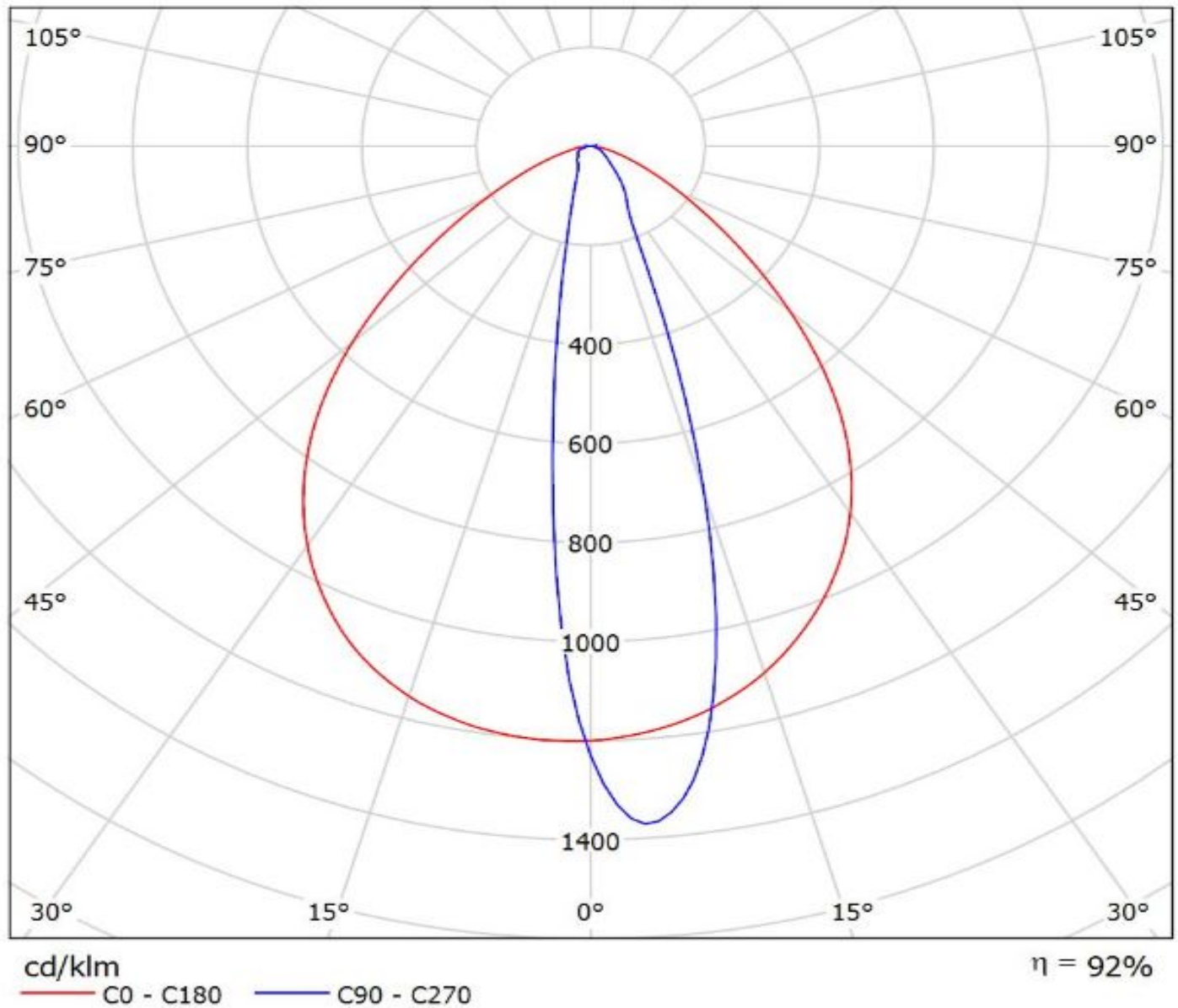

Ledil F14487_FLORENCE-1R-MAXI-WG_(Luxeon_A) / LDC (Polar)

Luminaire: Ledil F14487_FLORENCE-1R-MAXI-WG_(Luxeon_A)

Lamps: 1 x Luxeon_A_x12_(LXH8-PW30)_834.791lm@250mA_P=8.3W_I=0.25A

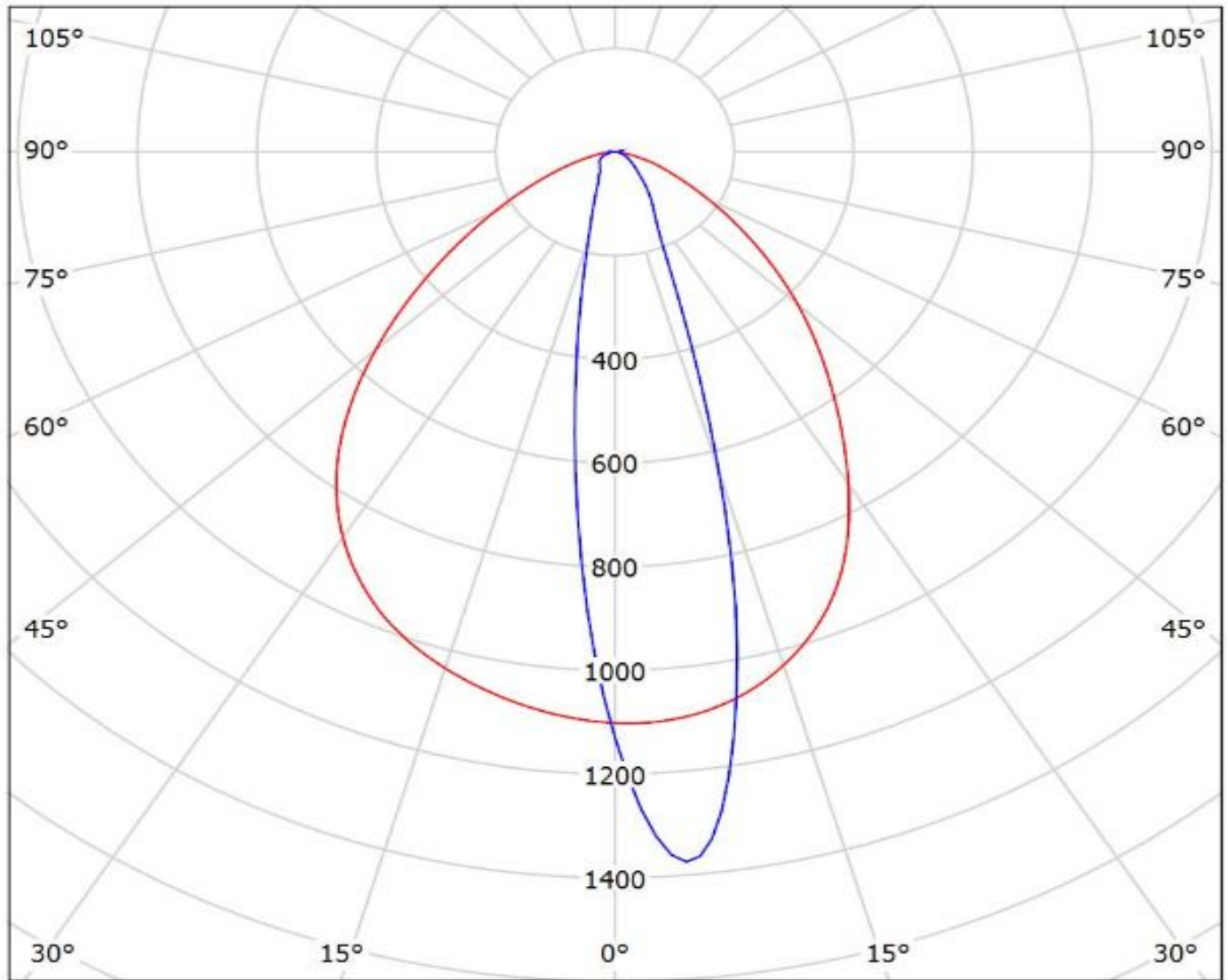

cd/klm

— C0 - C180 — C90 - C270

$\eta = 92\%$

Luminaire: LEDiL Oy F14487_FLORENCE-1R-MAXI-WG_(LUXEON_Z-ES)

Lamps: 1 x LUXEON_Z-ES_(LXZ2-3080-3)_882.543lm@250mA_CCT=3000K_P=8.27363W_I=249.8mA

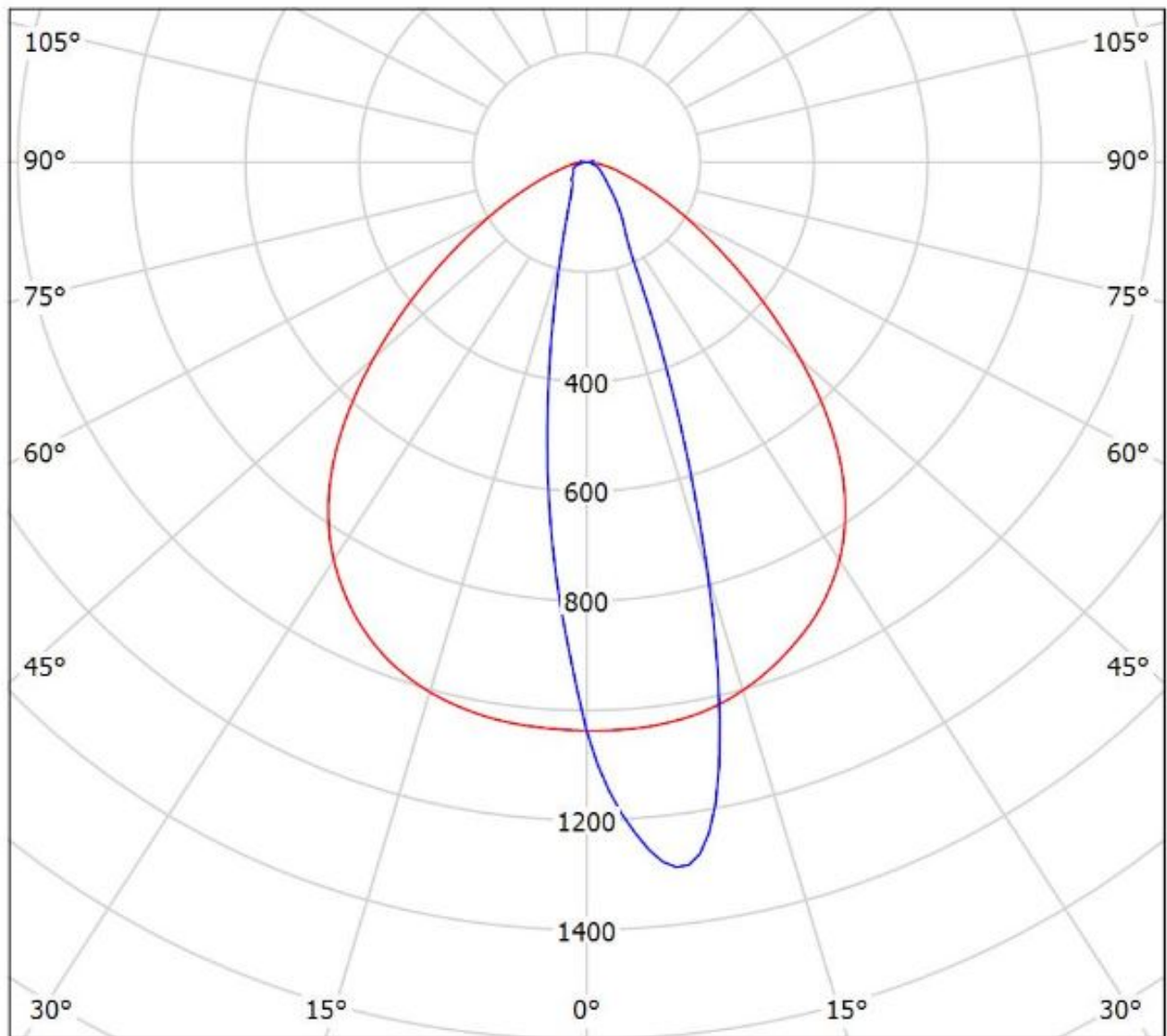

cd/klm

— C0 - C180 — C90 - C270

$\eta = 94\%$

Ledil F14487_FLORENCE-1R-MAXI-WG_(Luxeon_3030_2D) / LDC (Polar)

Luminaire: Ledil F14487_FLORENCE-1R-MAXI-WG_(Luxeon_3030_2D)
Lamps: 1 x Luxeon_3030_2D_x22_(L130-4080003000W21)
_1602.96lm@200mA_CCT=4000K_P=12.8W_I=0.2A

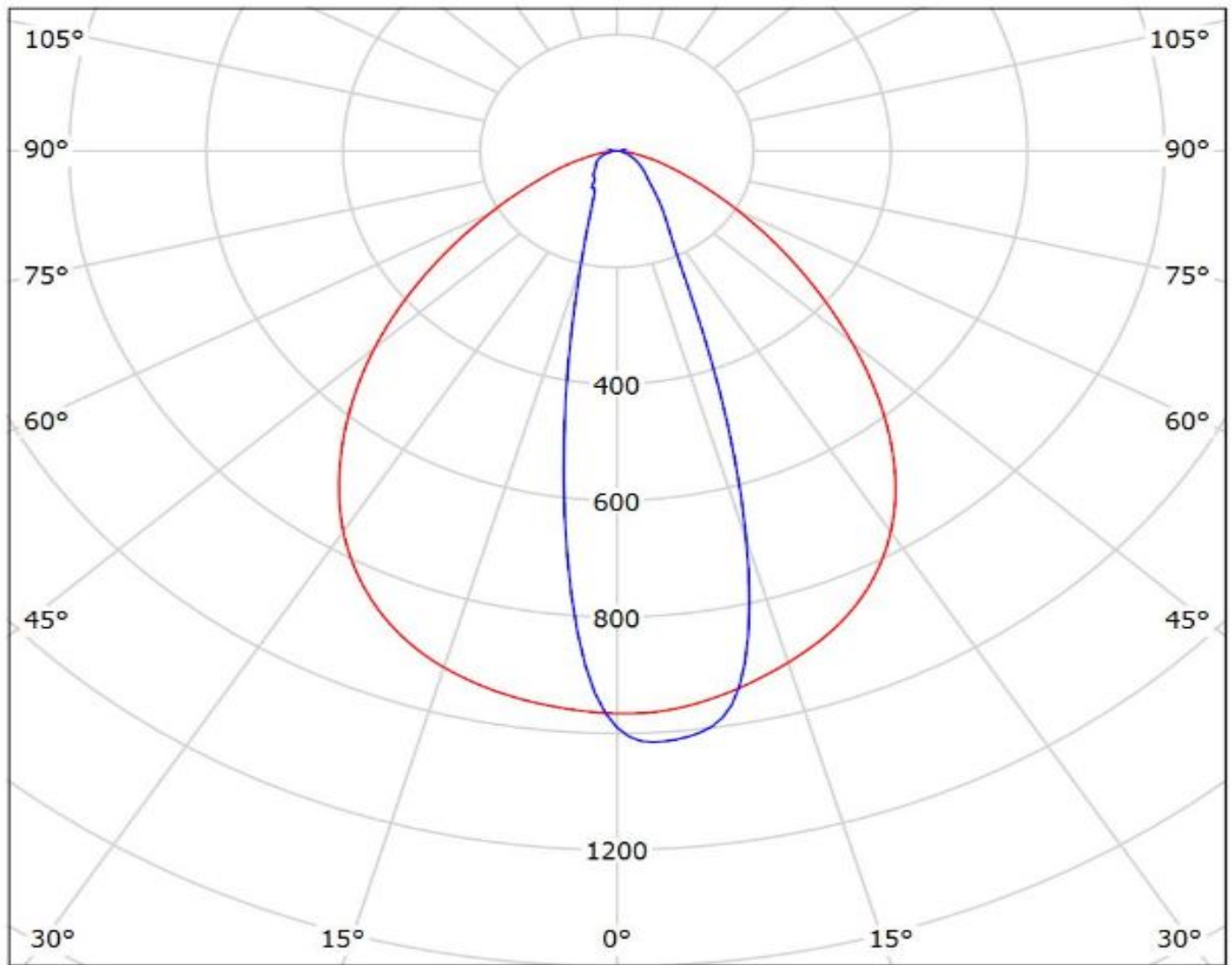

cd/klm

— C0 - C180 — C90 - C270

$\eta = 91\%$

Luminaire: Ledil F14487_FLORENCE-1R-MAXI-WG_(3014_x22)

Lamps: 1 x Luxeon_3014_x22_(L130-5080)_283.511lm@60mA_P=1.9087W_I=0.060mA

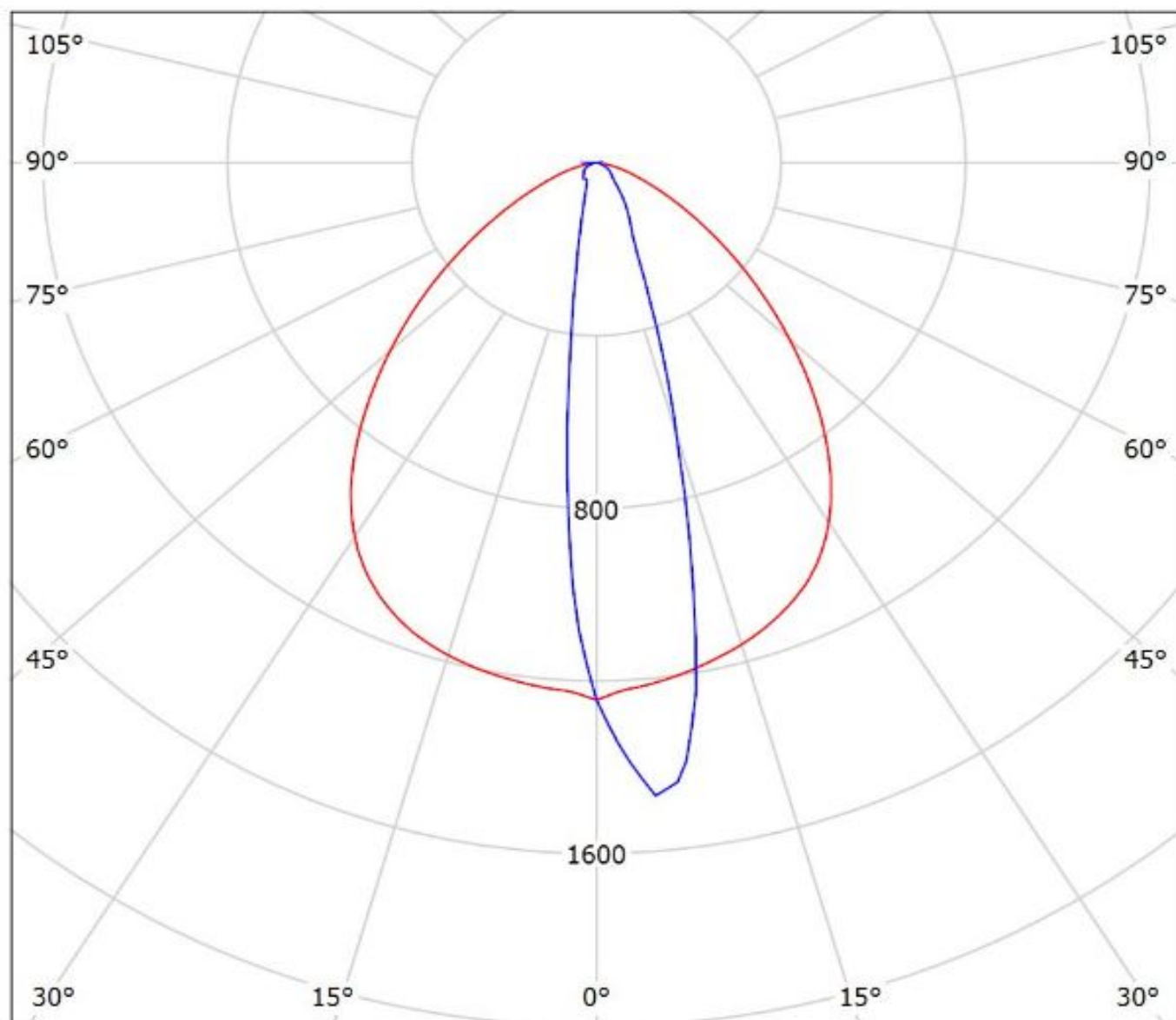

cd/klm

— C0 - C180 — C90 - C270

$\eta = 93\%$

Ledil F14487_FLORENCE-1R-MAXI-WG_(NCSxx19B) / LDC (Polar)

Luminaire: Ledil F14487_FLORENCE-1R-MAXI-WG_(NCSxx19B)

Lamps: 1 x Nichia_NCSxx19B_x12_(NCSL219B)_941.258lm@250mA_P=8.9W_I=0.25A

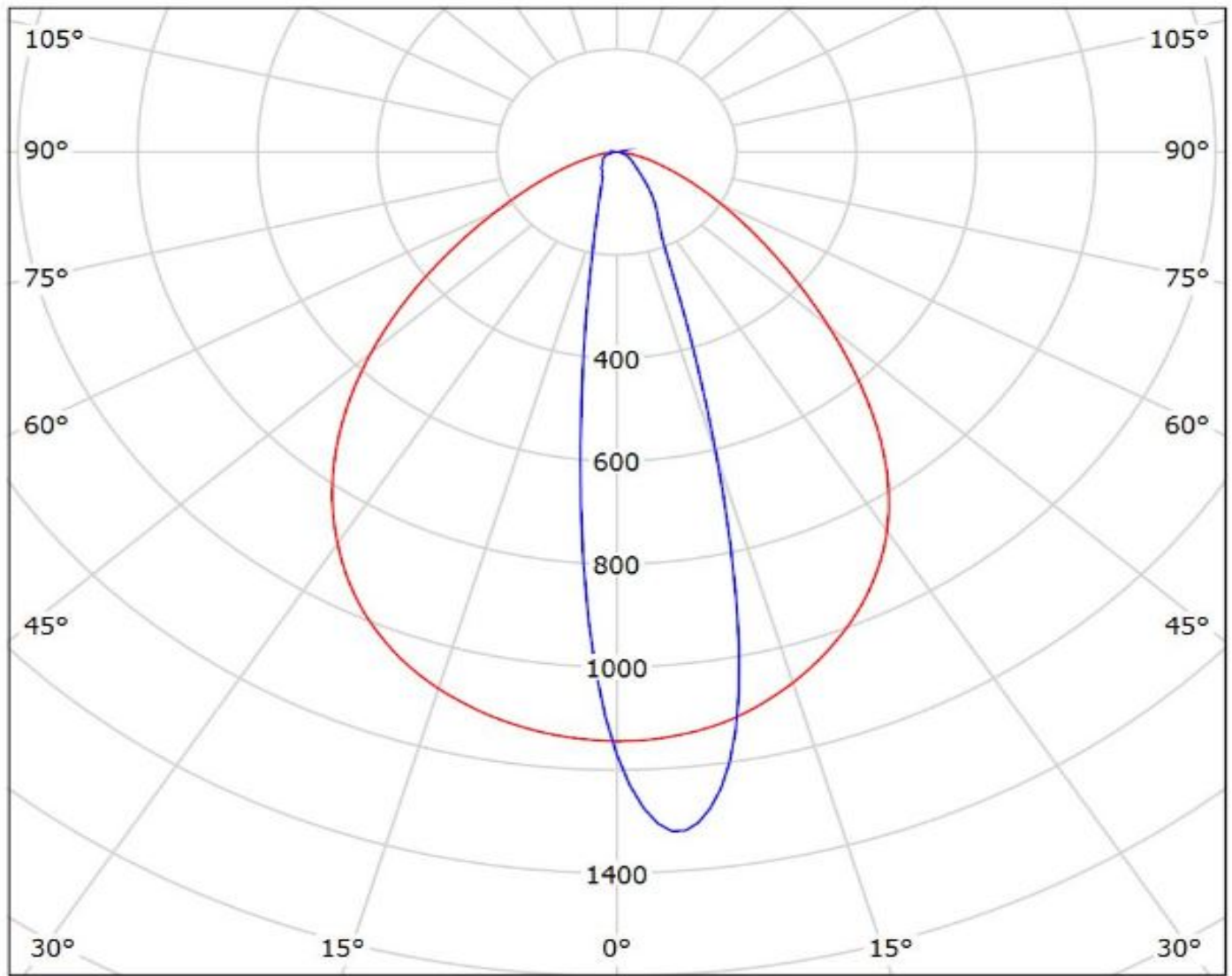

cd/klm

— C0 - C180

— C90 - C270

$\eta = 91\%$

Ledil F14487_FLORENCE-1R-MAXI-WG_(NVSxx19B) / LDC (Polar)

Luminaire: Ledil F14487_FLORENCE-1R-MAXI-WG_(NVSxx19B)

Lamps: 1 x Nichia_NVsxx19B_x12_(NVSL219B)_1045.07lm@250mA_P=8.6W_I=0.25A

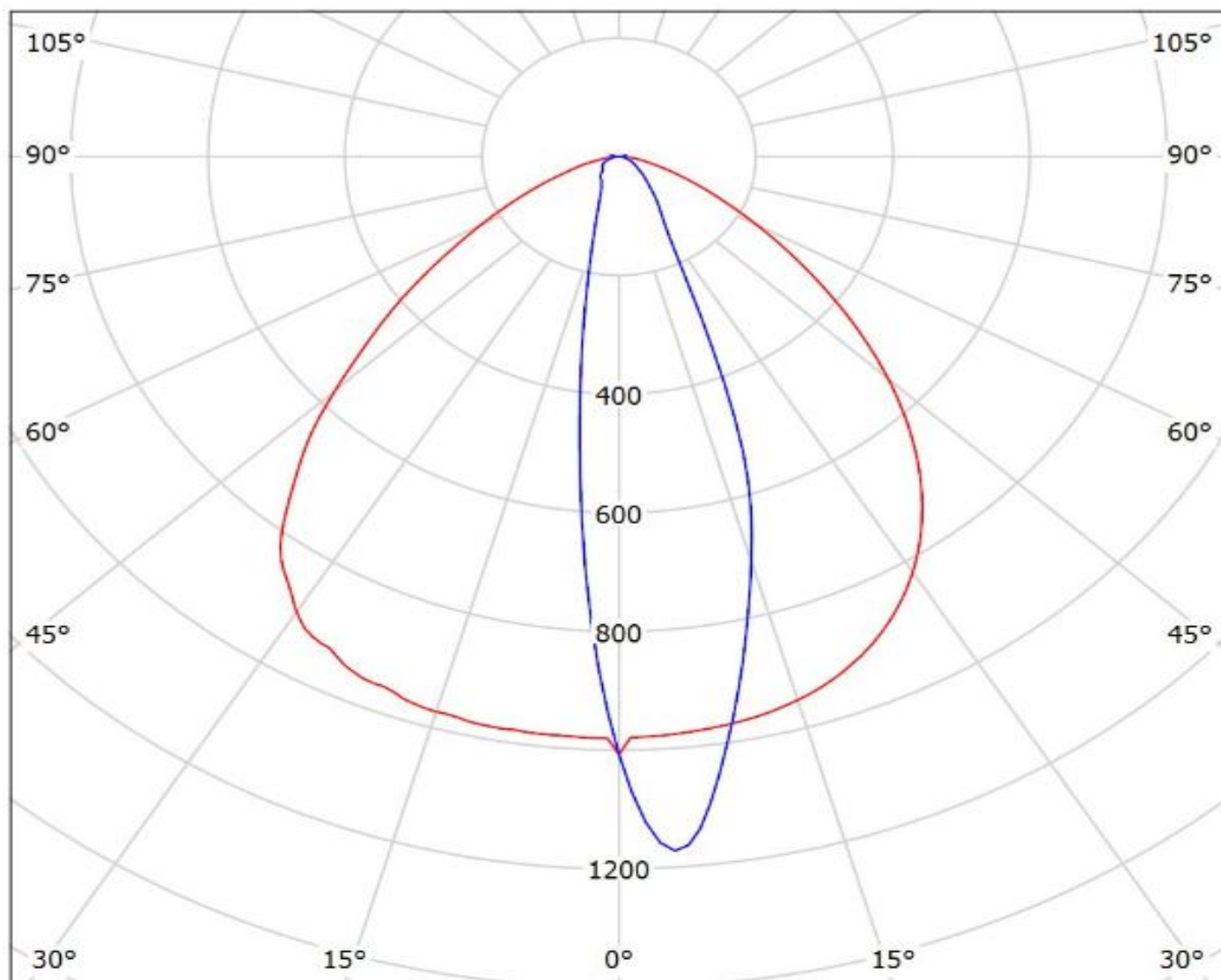

cd/klm

— C0 - C180 — C90 - C270

$\eta = 91\%$

Luminaire: Ledil F14487_FLORENCE-1R-MAXI-WG_(NF2W757G)
Lamps: 1 x NF2W757G_378.284lm@65mA_CCT=?K_P=1.97W_l=0.065A

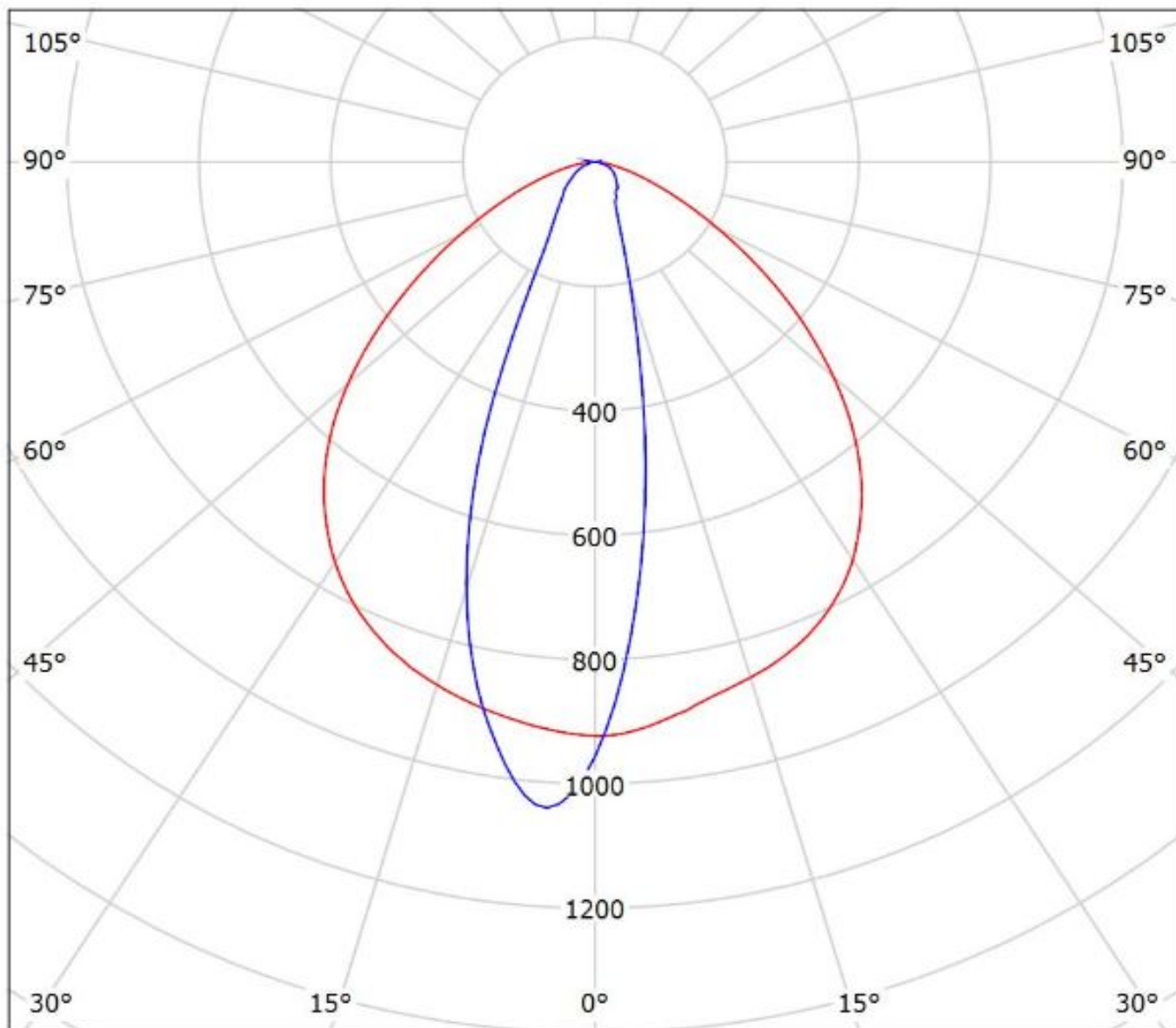

cd/klm
— C0 - C180 — C90 - C270

η = 90%

Ledil F14487_FLORENCE-1R-MAXI-WG_(Duris_S5-2chip) / LDC (Polar)

Luminaire: Ledil F14487_FLORENCE-1R-MAXI-WG_(Duris_S5-2chip)

Lamps: 1 x Osram_Duris_S5-2chip_x22_1225.67lm@150mA_P=9.55W_I=150mA

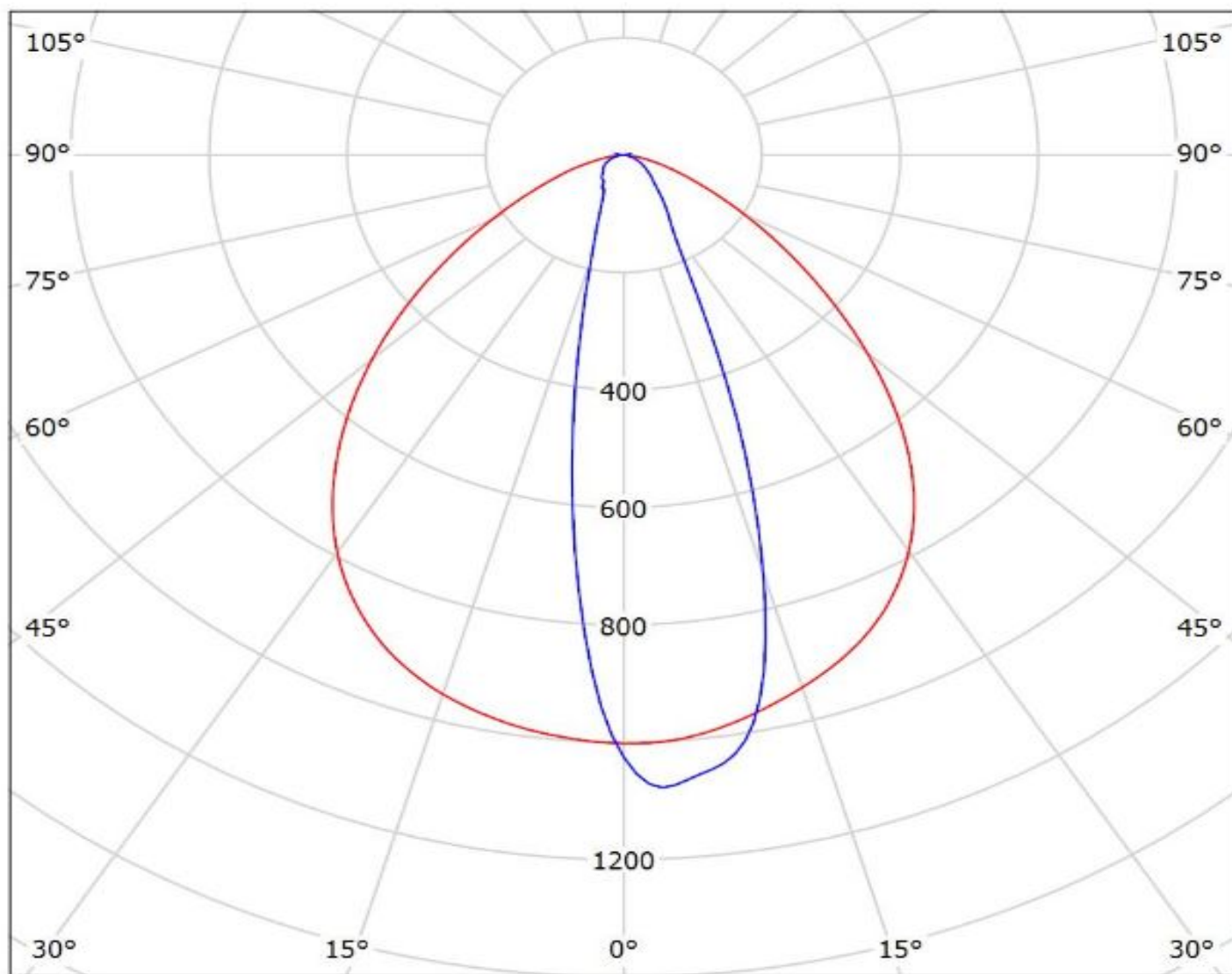

cd/klm

— C0 - C180 — C90 - C270

$\eta = 91\%$

Ledil F14487_FLORENCE-1R-MAXI-WG_(SSL80) / LDC (Polar)

Luminaire: Ledil F14487_FLORENCE-1R-MAXI-WG_(SSL80)

Lamps: 1 x Osram_Oslon_SSL80_x12_(LCW_CQ7P.EC)_838.967lm@250mA_P=9.3W_I=0.25A

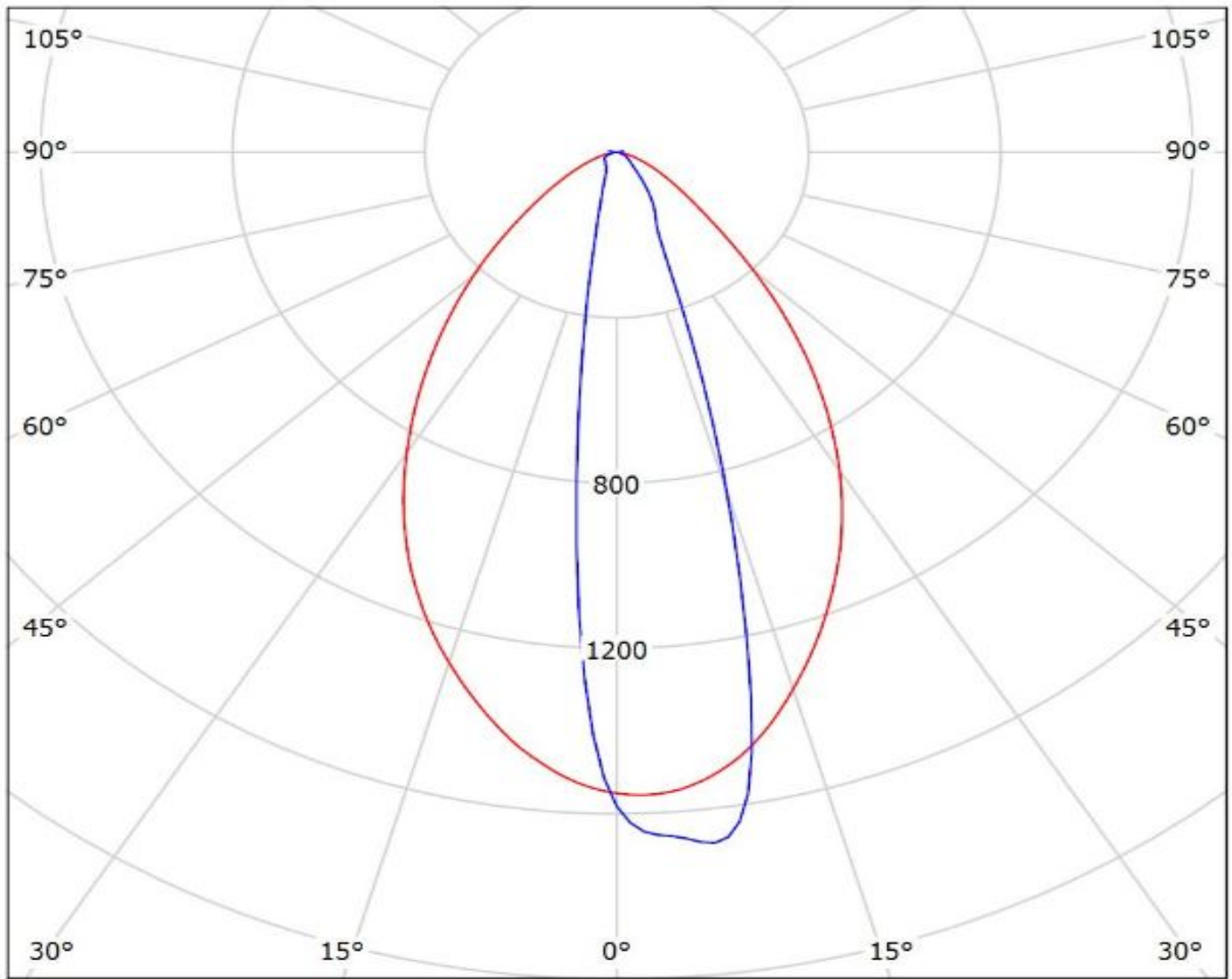

cd/klm

— C0 - C180 — C90 - C270

$\eta = 93\%$

Luminaire: Ledil Oy F14487_FLORENCE-1R-MAXI-WG_(Duris_E_2835)_SIMULATED
Lamps: 1 x Osram Duris E 2835 - GW JTLRS1.EM

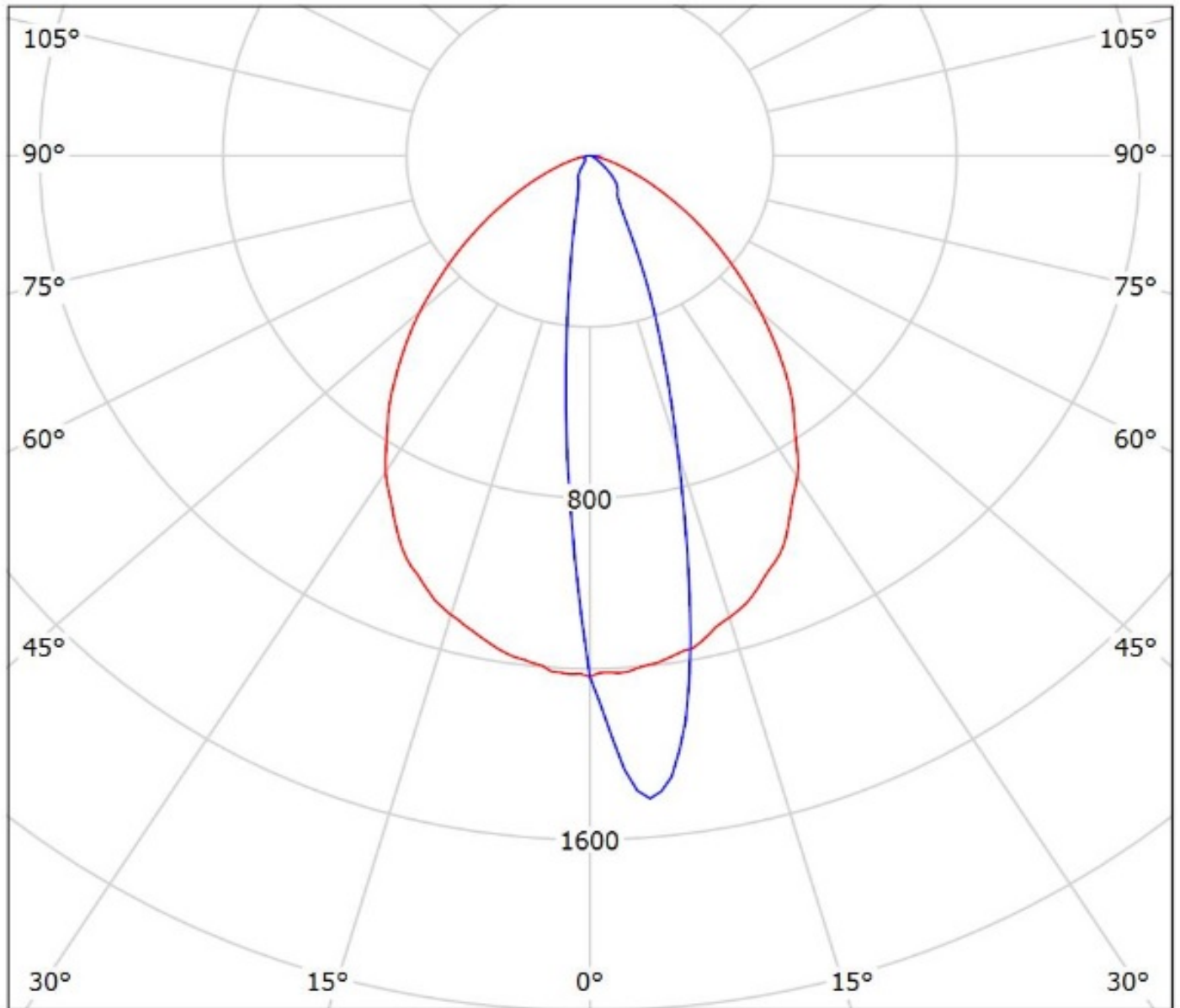

cd/klm

— C0 - C180 — C90 - C270

$\eta = 94\%$

Luminaire: LEDiL Oy F14487_FLORENCE-1R-MAXI-WG_(Fortimo_LED_line_1ft_1100lm_840_1R_LV2)
Lamps: 1 x Philips_Fortimo_LED_line_1ft_1100lm_840_1R_LV2_1067.99lm@250mA_P=8.04281W_I=0.2498mA

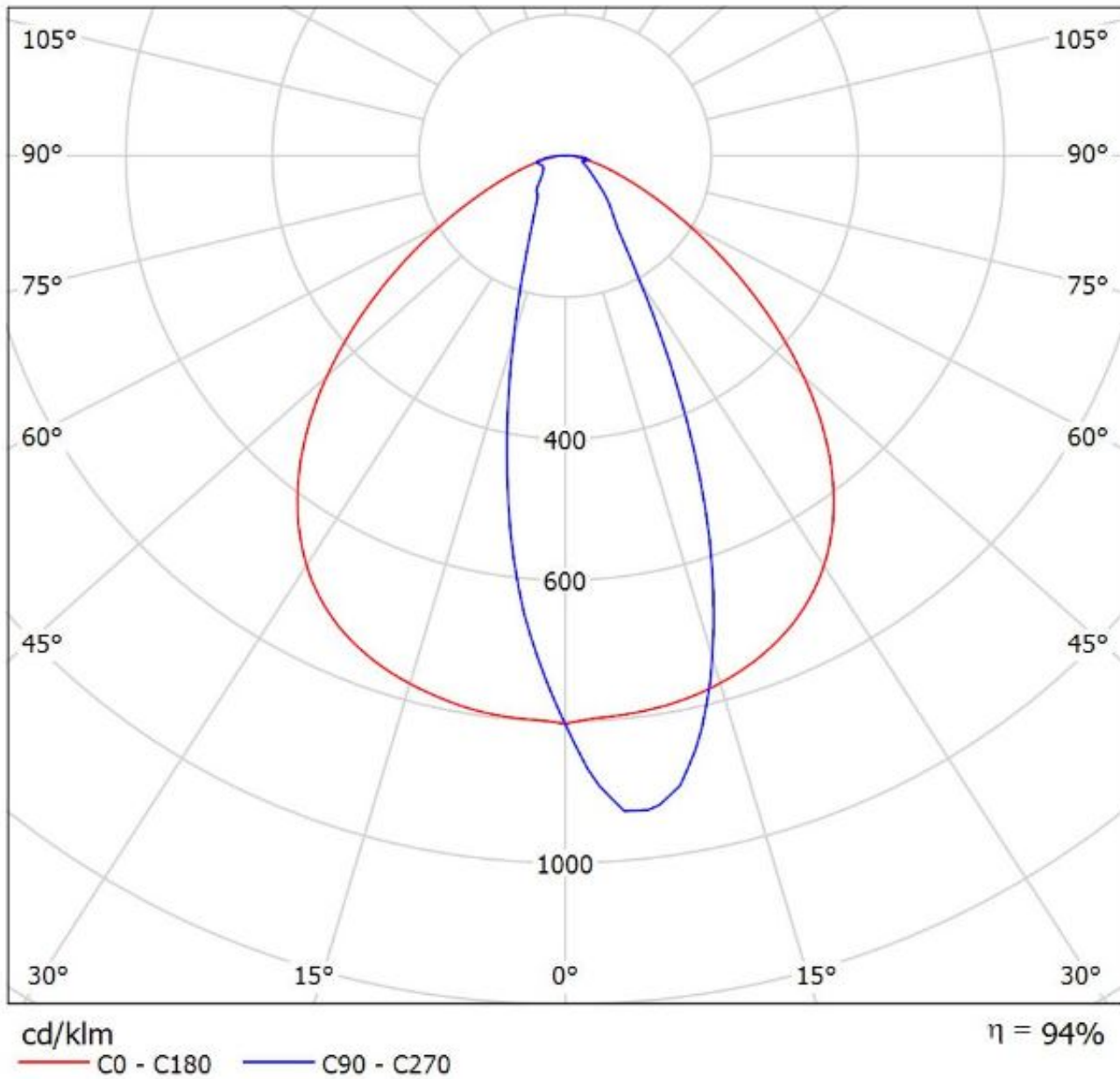

Luminaire: Ledil F14487_FLORENCE-1R-MAXI-WG_(LT-S282N)

Lamps: 1 x Samsung SI-B8T071280LD_LM5618+_1401.55lm@250mA_P=9.185W_I=0.25A

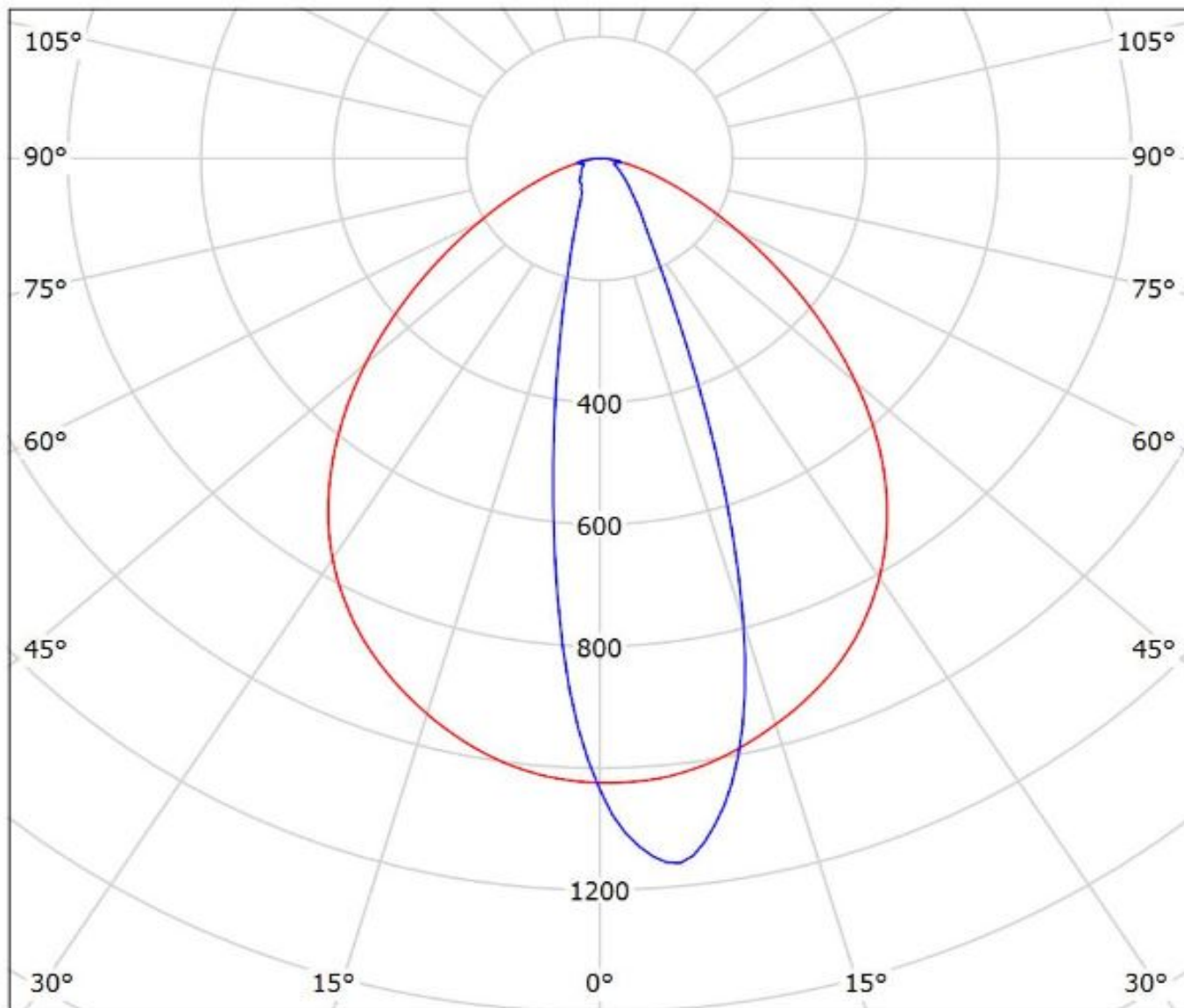

cd/klm

— C0 - C180 — C90 - C270

$\eta = 94\%$

Luminaire: Ledil F14487_FLORENCE-1R-MAXI-WG_(LM301A)

Lamps: 1 x Samsung_LM301A_x11_(SPMWHT328FD5WAT0S0)_1107.77lm@250mA_P=8.1W_I=0.25A

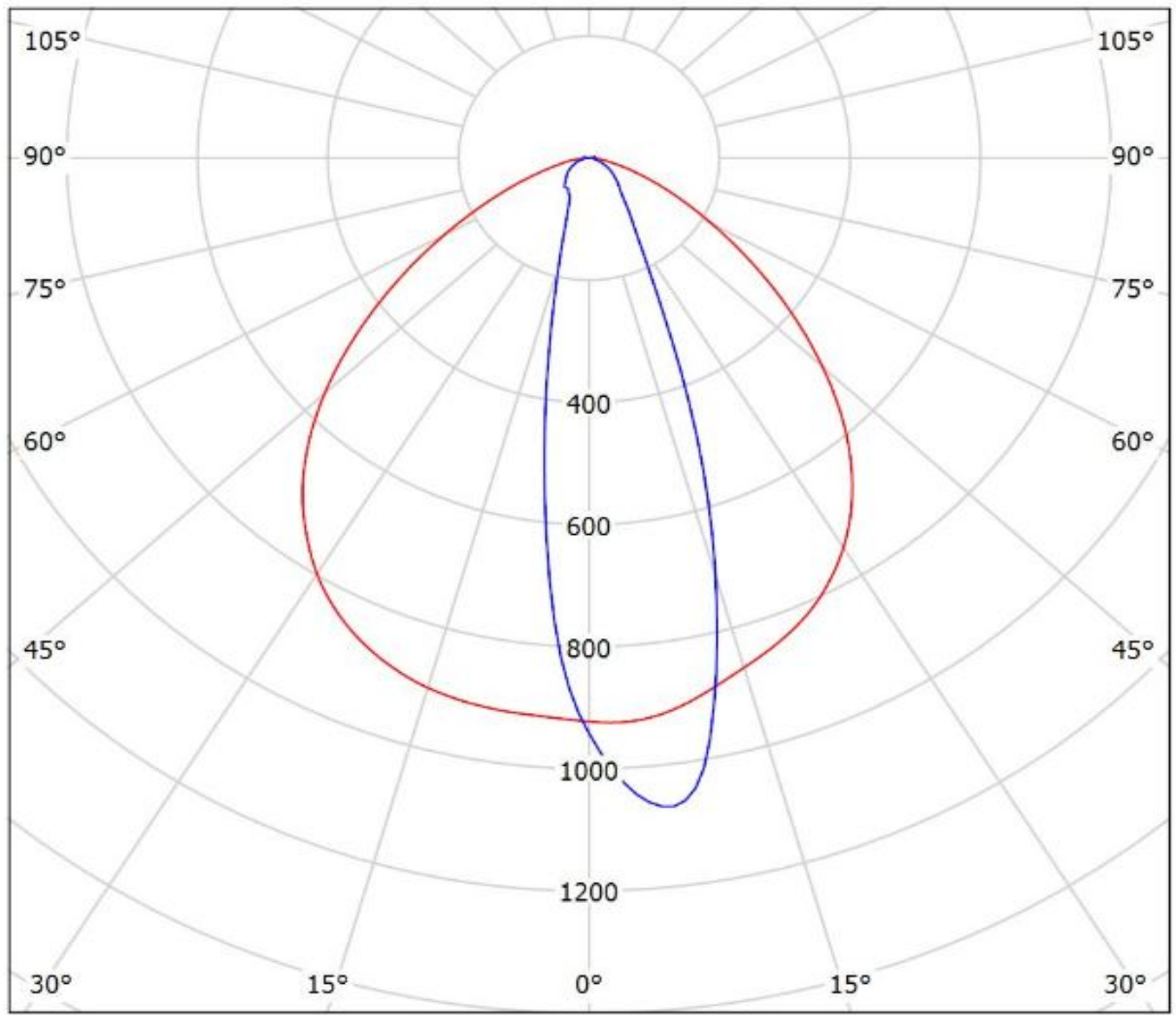

cd/klm

— C0 - C180

— C90 - C270

η = 91%

Luminaire: LEDiL Oy F14487_FLORENCE-1R-MAXI-WG_(LM561C)
Lamps: 1 x Samsung_LM561C_685.154lm@130mA_P=3.9367W_I=0.130A

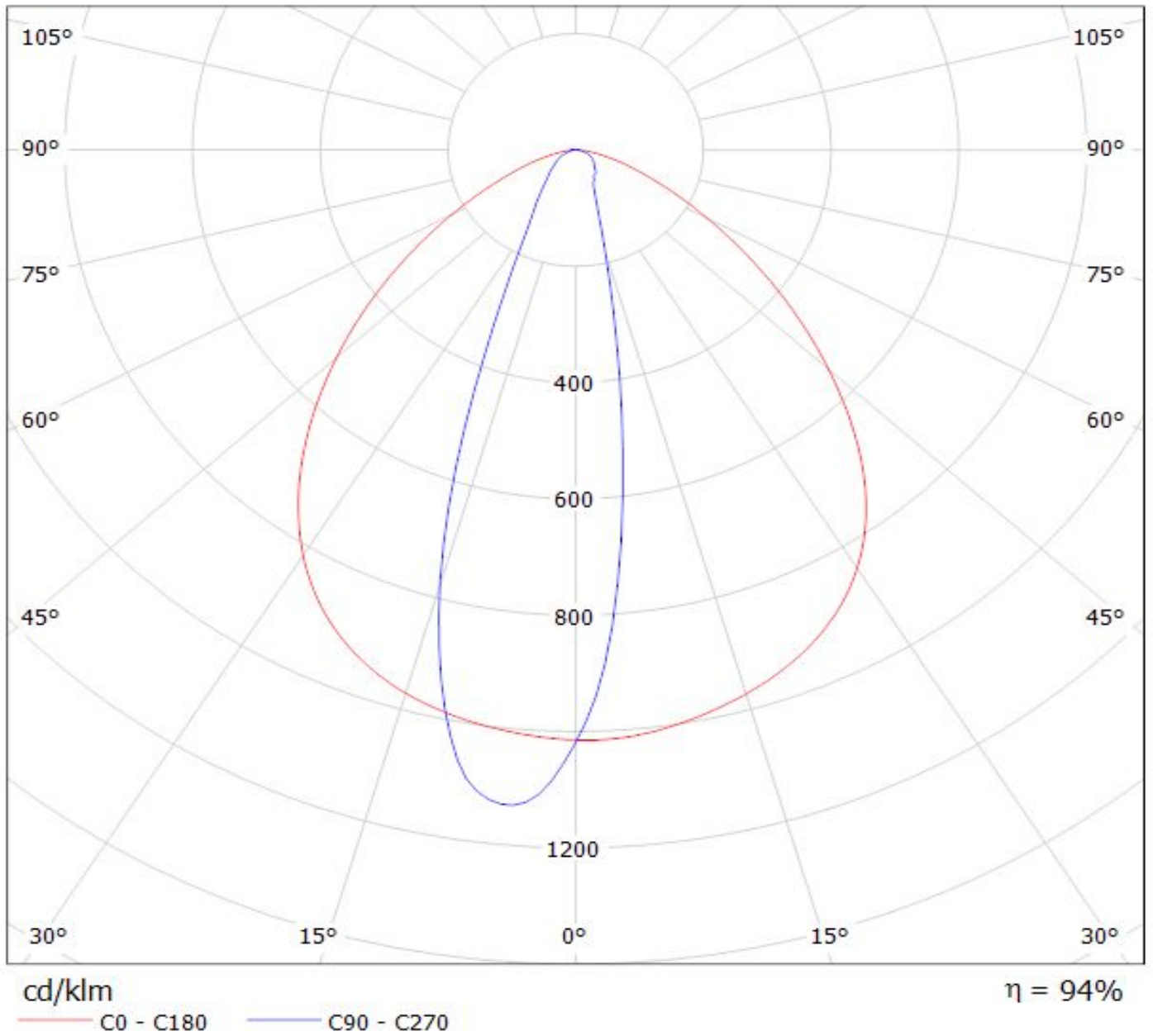

Luminaire: LEDiL Oy F14487_FLORENCE-1R-MAXI-WG_(LM281B)
Lamps: 1 x Samsung_LM281B_1309.14lm@300mA_P=10.244W_η=0.300A

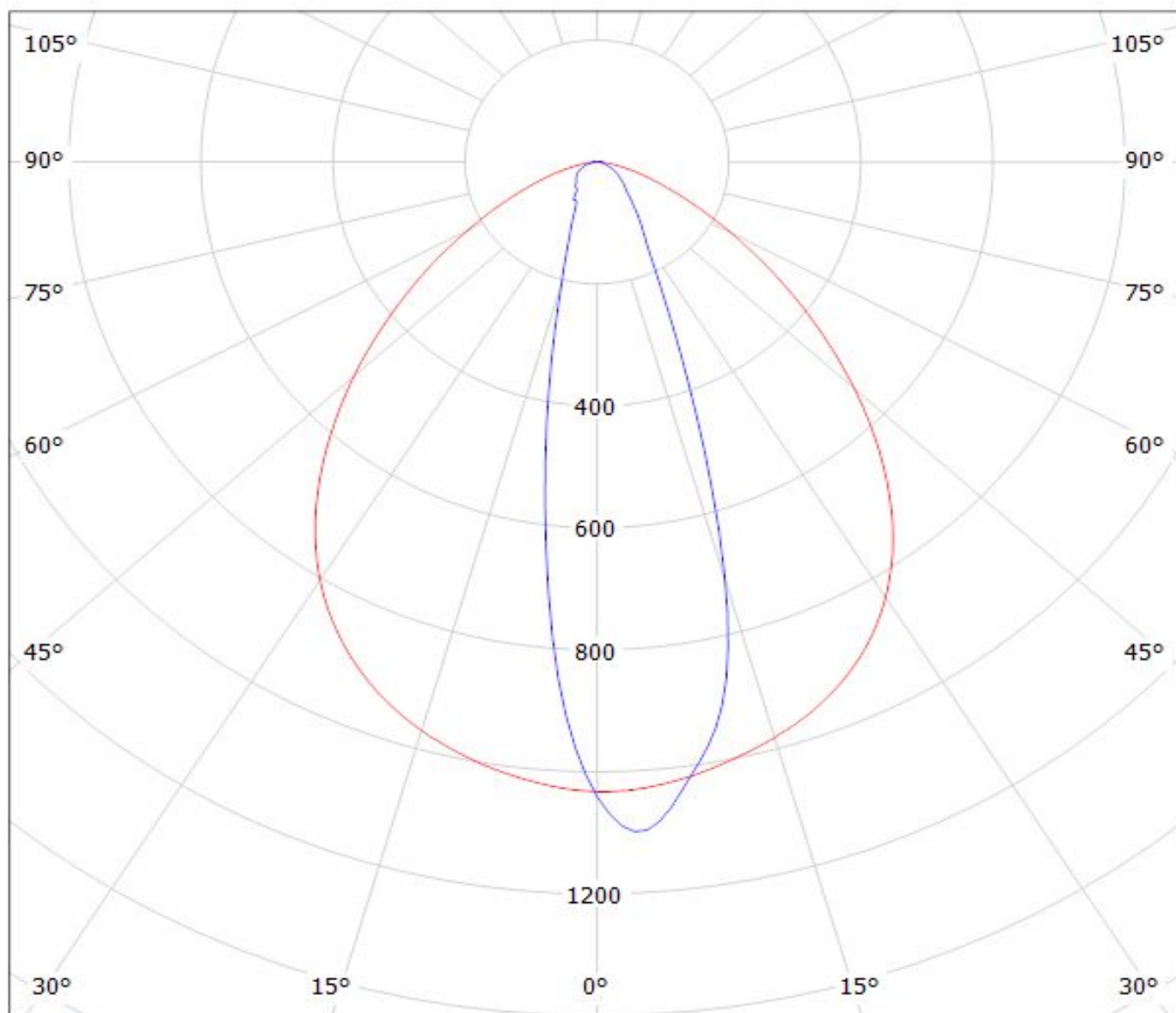

cd/klm

— C0 - C180

— C90 - C270

η = 93%

Luminaire: Ledil F14487_FLORENCE-1R-MAXI-WG_(CALGD0414-M8W1)

Lamps: 1 x Citizen_(CALGD0414-M8W1)_556.672lm@350mA_P=4.0291W_I=0.3499A

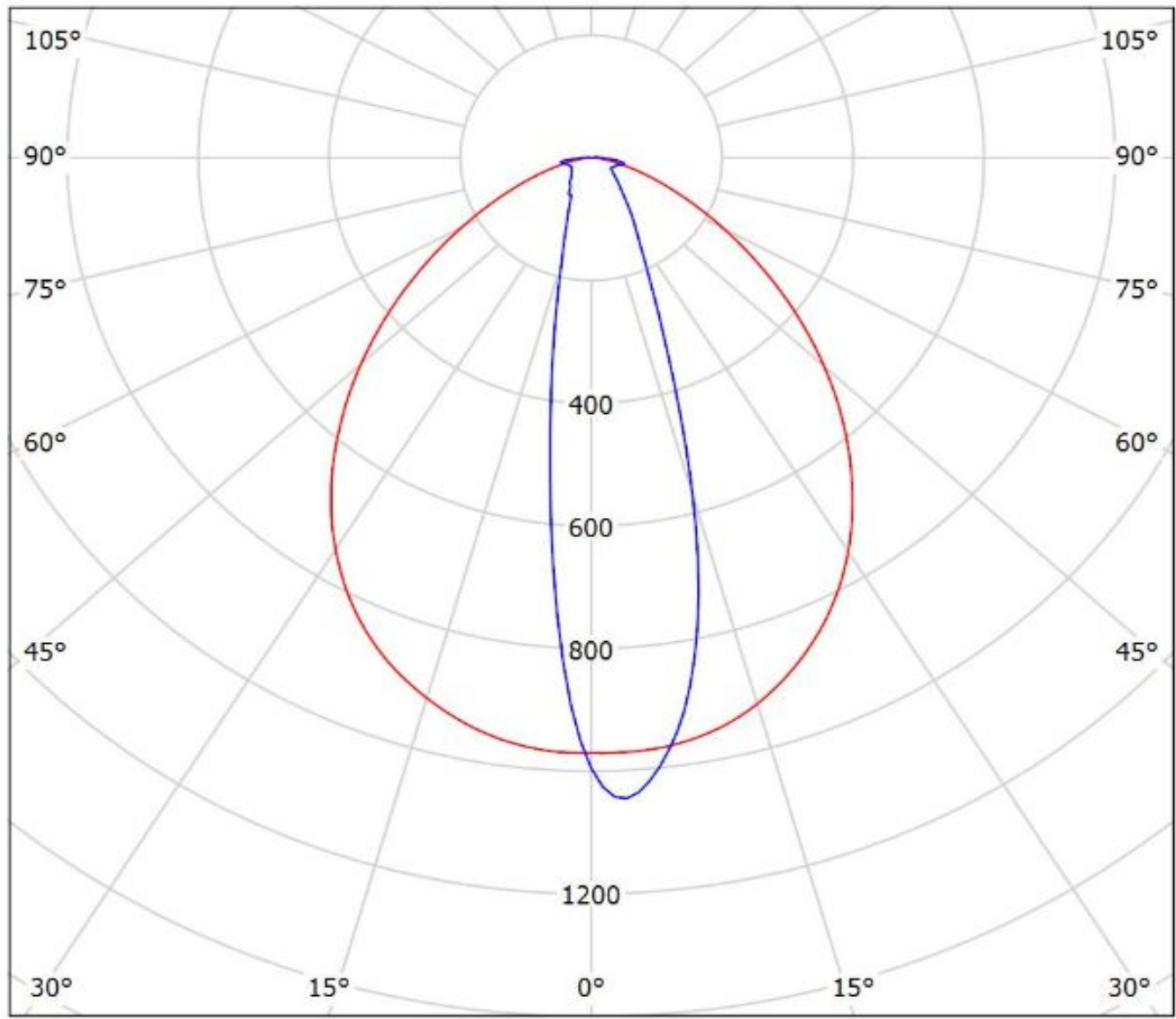

cd/klm
— C0 - C180 — C90 - C270

$\eta = 92\%$

Luminaire: Ledil F14487_FLORENCE-1R-MAXI-WG_(CALGD0814-M17W1)
Lamps: 1 x CALGD0814-M17W1_1094.82lm@350mA_P=7.9555W_I=0.35A

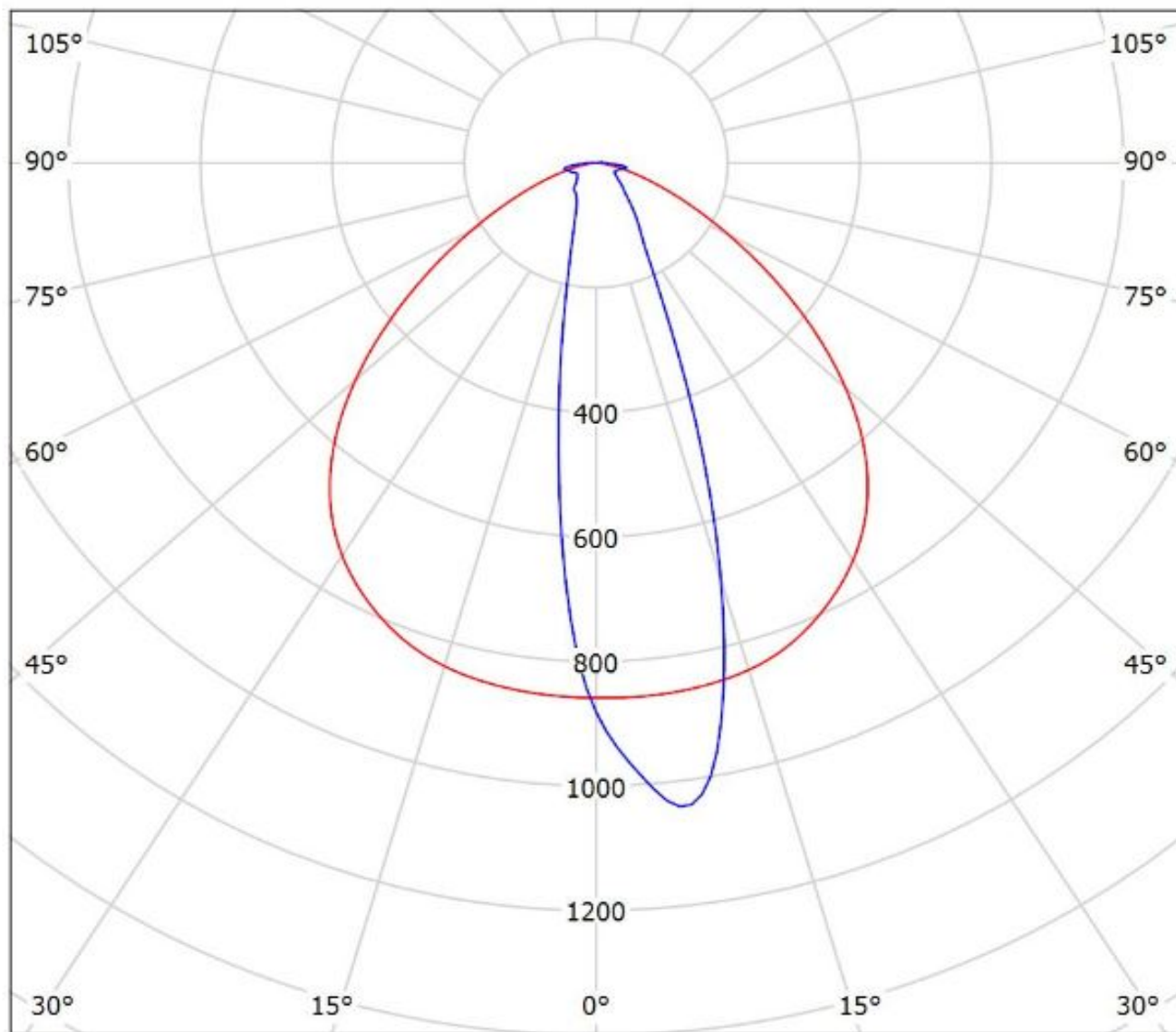

cd/klm
— C0 - C180 — C90 - C270

$\eta = 91\%$

NOTE: The typical divergence will be changed by different color, chip size and chip position tolerance. The typical total divergence is the full angle measured where the luminous intensity is half of the peak value.