

THESE DRAWINGS ARE THE PROPERTY OF QUALTEK ELECTRONICS AND NOT TO BE REPRODUCED FOR OR COMMUNICATED TO A THIRD PARTY WITHOUT THE EXPRESS WRITTEN PERMISSION OF AN OFFICER OF QUALTEK ELECTRONICS.

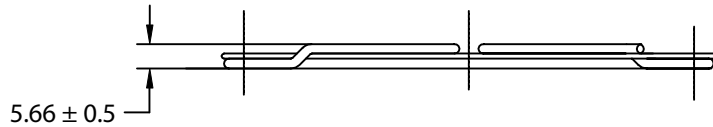
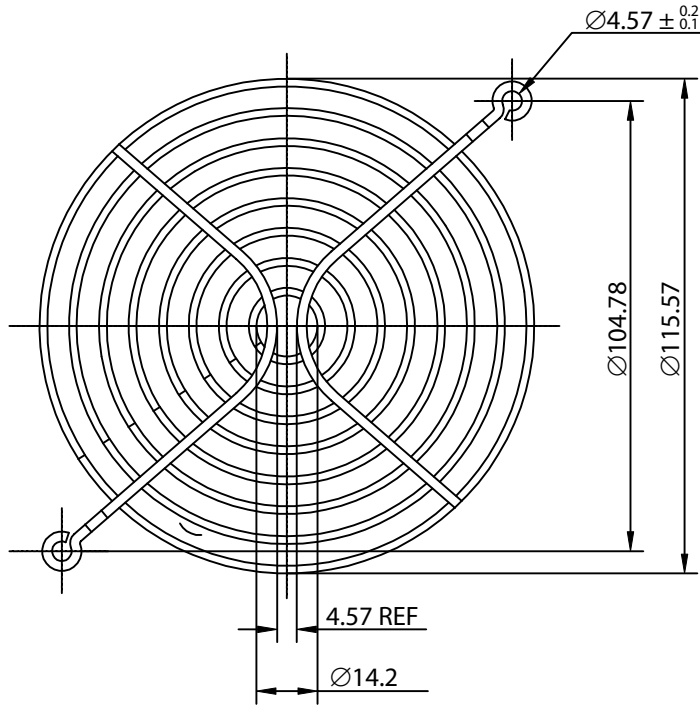

REVISION			
REV.	DESCRIPTION	DATE	APPROVED
B	RoHS Compliancy	06-01-06	DP

NOTES:

1. MATERIAL: C1008 BRIGHT BASIC WIRE
2. FINISH: BRIGHT NICKEL CHROME PLATING
3. 0.35 ± 0.05 DEPTH OF SERRATIONS ON WIRE
4. RING: $\varnothing 1.8 \pm 0.1$ mm
RIB: $\varnothing 2.3 \pm 0.1$ mm
5. GENERAL TOLERANCE UNLESS NOTED IS ± 0.5 mm
6. RoHS COMPLIANT

CONTROLLED

Dim range (mm)	Tolerance +/- (mm)	Qualtek Electronics Corp. FAN-S DIVISION		
		Part Number:	RoHS Compliant	
0-5	0.1	08139	WIRE FORM FAN GUARD (120mm)	
5-16	0.15			
16-64	0.2		UNIT: mm	REV: B
64-250	0.4	Drawn / Date	Checked / Date	Approved / Date
250-1000	0.5	B. ZHANG 04-01-03	04-01-03	JJH / 04-01-03
1000-1500	1.0			