

ZWS300BAF/A

SPECIFICATIONS

A254-01-01/A-B

ITEMS		MODEL	ZWS300BAF -12/A	ZWS300BAF -15/A	ZWS300BAF -24/A	ZWS300BAF -36/A	ZWS300BAF -48/A
1	Nominal Output Voltage	V	12	15	24	36	48
2	Maximum Output Current	A	25.0	20.0	12.5	8.4	6.3
3	Maximum Output Power	W	300.0	300.0	300.0	302.4	302.4
4	Efficiency (Typ)	100VAC	86		88		
		(*)200VAC	89		91		
5	Input Voltage Range	(*)2)(*)3	85 - 265VAC (47 - 63Hz) or 120 - 370VDC				
6	Input Current (Typ)	(*)1	3.7/1.9		3.6/1.8		
7	Inrush Current (Typ)	(*)1)(*)4	15A at 100VAC, 30A at 200VAC, Ta=25°C, Cold Start				
8	PFHC	-	Designed to meet IEC61000-3-2				
9	Power Factor (Typ)	(*)1	0.97/0.93				
10	Output Voltage Range	V	9.6 - 13.2	13.5 - 16.5	21.6 - 27.5	32.4 - 39.6	39.5 - 52.8
11	Maximum Ripple & Noise	0≤Ta≤70°C	150	150	150	250	250
		(*)5)-10≤Ta<0°C	180	180	180	300	300
12	Maximum Line Regulation	(*)5)(*)6	48	60	96	144	192
13	Maximum Load Regulation	(*)5)(*)7	100	120	150	240	240
14	Temperature Coefficient	(*)5)	Less than 0.02% / °C				
15	Over Current Protection	(*)8	26.25 -	23.1-	14.7 -	9.87 -	7.35 -
16	Over Voltage Protection	(*)9	13.8 - 16.2	17.3 - 20.3	28.8 - 33.6	41.4 - 48.6	55.2 - 64.8
17	Hold-up Time (Typ)	(*)1	18ms(typ) at 100VAC & Rated O/P Power, 20ms(typ) at 100VAC & 80% Load				
18	Leakage Current	(*)10	Less than 0.5mA. 0.2mA (Typ) at 100VAC / 0.4mA (Typ) at 230VAC				
19	Parallel Operation	-	-				
20	Series Operation	-	Possible				
21	Operating Temperature	-	-10 - +60°C (-10 - +20°C:100%, +30°C:85%, +40°C:70%, +50°C:55%, +60°C:40%)		-10 - +60°C (-10 - +30°C:100%, +40°C:80%, +50°C:60%, +60°C:40%)		
		(*)11					
22	Operating Humidity	-	30 - 90%RH (No Condensing)				
23	Storage Temperature	-	-30 - +75°C				
24	Storage Humidity	-	10 - 90%RH (No Condensing)				
25	Cooling	-	Convection Cooling				
26	Withstand Voltage	-	Input - FG : 2kVAC (10mA), Input - Output : 3kVAC (10mA) Output - FG : 500VAC (20mA) for 1min				
27	Isolation Resistance	-	More than 100MΩ at 25°C and 70%RH Output - FG : 500VDC				
28	Vibration	-	At no operating, 10 - 55Hz (Sweep for 1min) 19.6m/s ² Constant, X,Y,Z 1hour each.				
29	Shock	-	Less than 196.1m/s ²				
30	Safety	-	Approved by UL60950-1, CSA60950-1, EN60950-1, EN50178 (OV II), Designed to meet DENAN at 100VAC only.				
31	Conducted Emission	-	Designed to meet EN55011/EN55022-B, FCC-B, VCCI-B				
32	Radiated Emission	-	Designed to meet EN55011/EN55022-B, FCC-B, VCCI-B				
33	Immunity	-	Designed to meet IEC61000-6-2 IEC61000-4-2, -3, -4, -5, -6, -8, -11				
34	Weight (Typ)	g	800				
35	Size (W x H x D)	mm	95 x 53 x 212 (Refer to Outline Drawing)				

*Read instruction manual carefully, before using the power supply unit.

=NOTES=

- *1. At 100VAC/200VAC, Ta=25°C, nominal output voltage and maximum output power.
- *2. For cases where conformance to various safety specs (UL, CSA, EN) are required, to be described as 100 - 240VAC (50-60Hz).
- *3. Output derating needed when input voltage less than 90VAC.
Refer to LOAD vs. INPUT VOLTAGE (24V/36V/48V: A254-01-02/A-_, 12V/15V: A254-01-06/A-_).
- *4. Not applicable for the in-rush current to Noise Filter for less than 0.2ms.
- *5. Please refer to Fig. A for measurement of Vo, line & load regulation and ripple voltage.
- *6. 90 - 265VAC, constant load.
- *7. No load-Full load, constant input voltage.
- *8. Constant current limit with automatic recovery.
Avoid to operate at over load or short circuit condition.
- *9. OVP circuit will shut down output, manual reset (Re power on).
- *10. Measured by the each measuring method of UL, CSA, EN and DENAN (at 60Hz), Ta=25°C.
- *11. Output Derating
 - Derating at standard mounting.
Refer to LOAD vs. AMBIENT TEMPERATURE (24V/36V/48V: A254-01-02/A-_, 12V/15V: A254-01-06/A-_).
 - When forced air cooling, refer to forced air cooling specifications
(A254-01-03/A-_, 24V/36V/48V: A254-01-04/A-_, 12V/15V: A254-01-08/A-_).
 - Load (%) is percent of maximum output power or maximum output current, do not exceed its derating of maximum load.

Fig. A

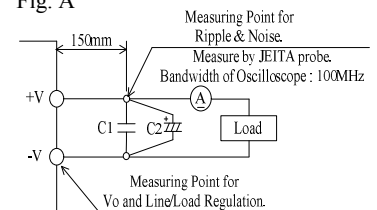

C1 : Film Cap. 0.1 μF
C2 : Elect. Cap. 100 μF

ZWS300BAF/A

OUTPUT DERATING

A254-01-02/A

*COOLING : CONVECTION COOLING

Ta (°C)	LOAD (%)		
	MOUNTING A	MOUNTING B	MOUNTING C
-10 - +25	100	100	100
30	100	91	90
40	80	74	70
50	60	57	50
60	40	40	30

Ta (°C)	LOAD (%)	
	MOUNTING D,E	MOUNTING F
-10 - +10	100	100
20	84	82
30	68	64
40	52	46
50	36	28
60	20	10

*COOLING : CONVECTION COOLING

INPUT VOLTAGE (VAC)	LOAD (%)
	MOUNTING A-F
85	80
90 - 265	100

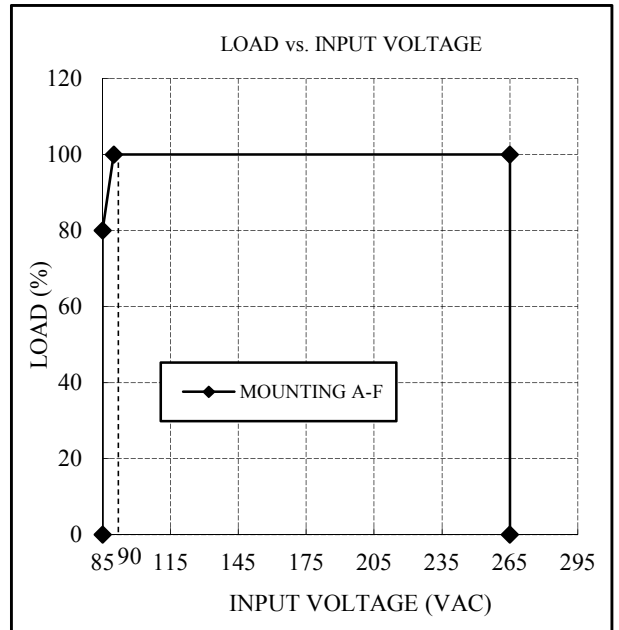
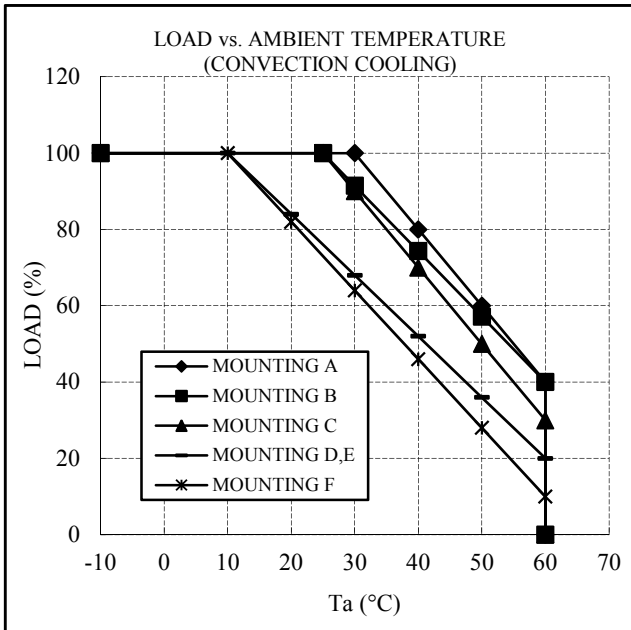

- MOUNTING A MOUNTING B MOUNTING C MOUNTING D MOUNTING E MOUNTING F

(STANDARD MOUNTING)

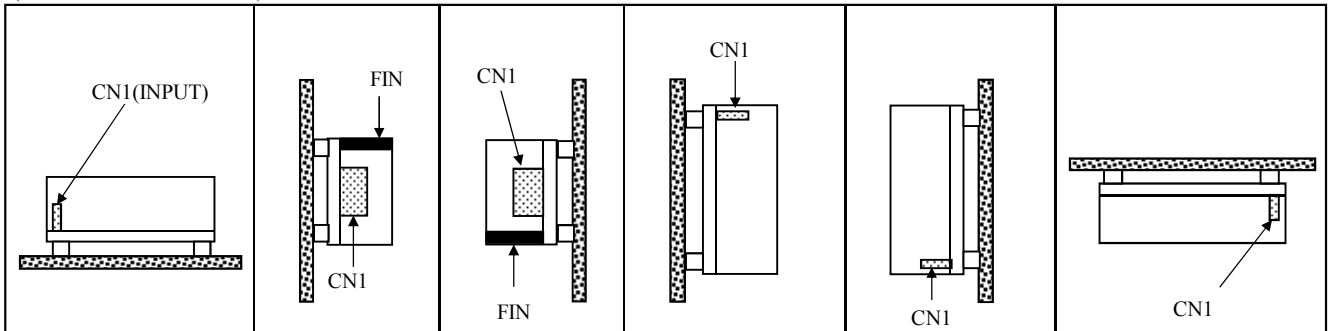

ZWS300BAF/A

SPECIFICATIONS

A254-01-03/A-A

MODEL		ZWS300BAF	ZWS300BAF	ZWS300BAF	ZWS300BAF	ZWS300BAF	
ITEMS		-12/A	-15/A	-24/A	-36/A	-48/A	
1	Nominal Output Voltage	V	12	15	24	36	48
2	Maximum Output Current (*1)	A	25.0	22.0	14.0	9.4	7.0
3	Maximum Output Power (*1)	W	300.0	330.0	336.0	338.4	336.0
4	Efficiency (Typ)	100VAC	86		87		
		200VAC (*2)	89		90		
5	Input Voltage Range (*3)(*4)	-	85 - 265VAC (47 - 63Hz) or 120 - 370VDC				
6	Input Current (Typ) (*2)	A	3.7/1.9	4.0/2.0			
7	Hold-up Time (Typ) (*2)	-	18ms(typ) at 100VAC & Rated O/P Power, 20ms(typ) at 100VAC & 80% Load	16ms(typ) at 100VAC & Rated O/P Power, 20ms(typ) at 100VAC & 70% Load			
8	Operating Temperature	-	-	-10 - +60°C (-10 - +40°C:100%, +50°C:80%, +60°C:60%) (Air velocity≥0.7m/s)			
		-	-10 - +60°C (-10 - +40°C:100%, +50°C:80%, +60°C:60%) (Air velocity≥1.4m/s)	-10 - +60°C (-10 - +50°C:100%, +60°C:70%) (Air velocity≥1.4m/s)			
9	Cooling (*1)	-	Forced Air Cooling				
10	Radiated Emission	-	Designed to meet EN55011/EN55022-A, FCC-A, VCCI-A				

*For other specification items, refer to standard specifications.

=NOTES=

- *1. Forced air cooling with air velocity more than 0.7m/s for 24V/36V/48V.
Forced air cooling with air velocity more than 1.4m/s for 12V/15V.
(Measured at component side of PCB, air must flow through component side).
- *2. At 100VAC/200VAC, Ta=25°C, nominal output voltage and maximum output power.
- *3. For cases where conformance to various safety specs (UL, CSA, EN) are required, to be described as 100 - 240VAC (50-60Hz).
- *4. Output derating needed when input voltage less than 90VAC. Refer to LOAD vs. INPUT VOLTAGE
(24V/36V/48V: A254-01-02/A-_, 12V/15V: A254-01-06/A-_).
- *5. Output Derating
- When forced air cooling, refer to LOAD vs. AMBIENT TEMPERATURE (24V/36V/48V: A254-01-04/A-_, 12V/15V: A254-01-08/A-_
- Load (%) is percent of maximum output power or maximum output current, do not exceed its derating of maximum load.

ZWS300BAF/A

OUTPUT DERATING

A254-01-04/A

***COOLING : FORCED AIR COOLING**

Ta (°C)	LOAD (%)
	MOUNTING A-F
-10 - +40	100
60	60

Air velocity $\geq 0.7\text{m/s}$:
Air must flow through component side.

Ta (°C)	LOAD (%)
	MOUNTING A-F
-10 - +50	100
60	70

Air velocity $\geq 1.4\text{m/s}$:
Air must flow through component side.

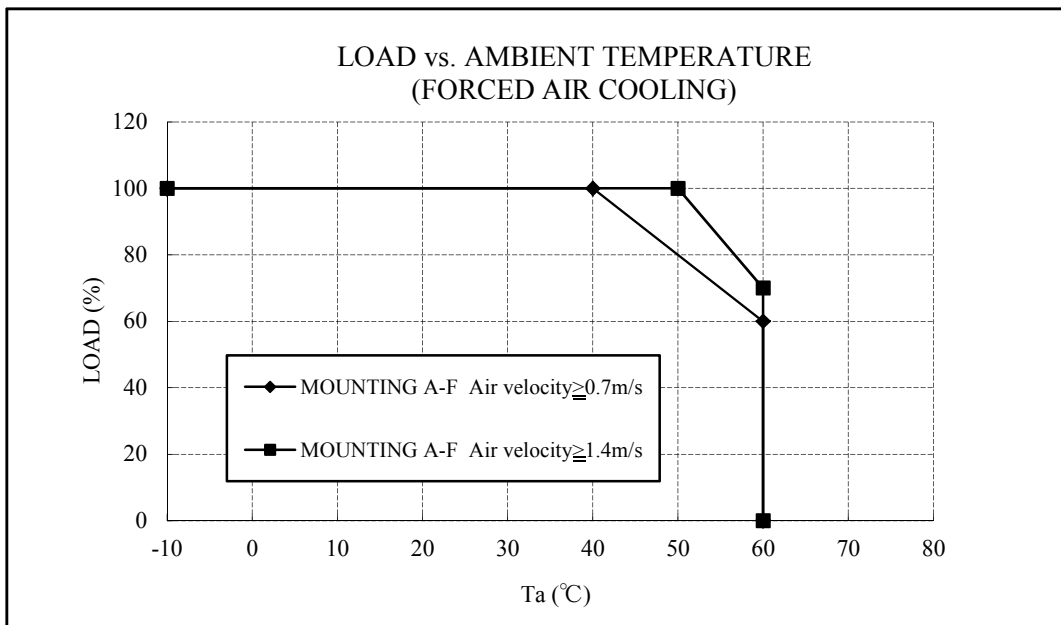

- MOUNTING A
- MOUNTING B
- MOUNTING C
- MOUNTING D
- MOUNTING E
- MOUNTING F

(STANDARD MOUNTING)

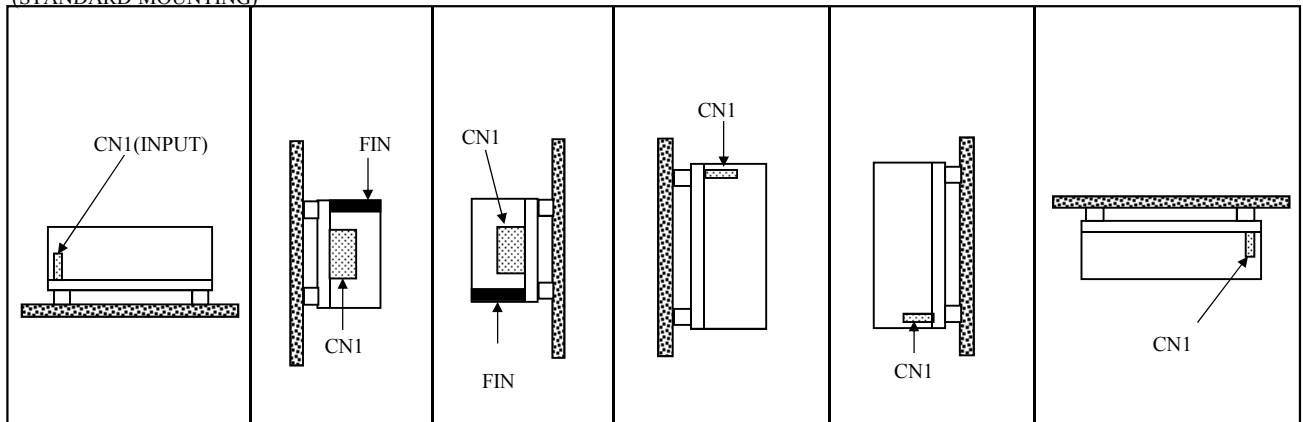

ZWS300BAF/A

OUTPUT DERATING (12V, 15V)

A254-01-06/A

*COOLING : CONVECTION COOLING

Ta (°C)	LOAD (%)		
	MOUNTING A	MOUNTING B	MOUNTING C
-10 - +10	100	100	100
20	100	86	100
30	85	72	83
40	70	58	65
50	55	44	48
60	40	30	30

Ta (°C)	LOAD (%)	
	MOUNTING D,E	MOUNTING F
-10 - 0	100	100
10	86	85
20	73	70
30	60	55
40	46	40
50	33	25
60	20	10

INPUT VOLTAGE (VAC)	LOAD (%)
	MOUNTING A-F
85	80
90 - 265	100

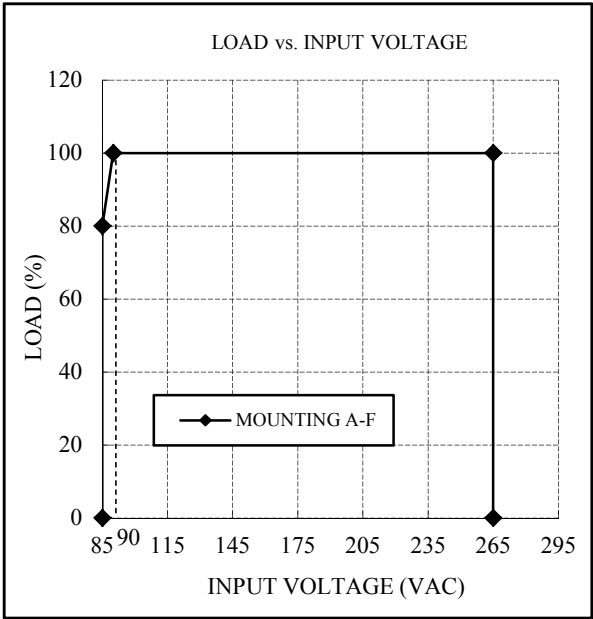
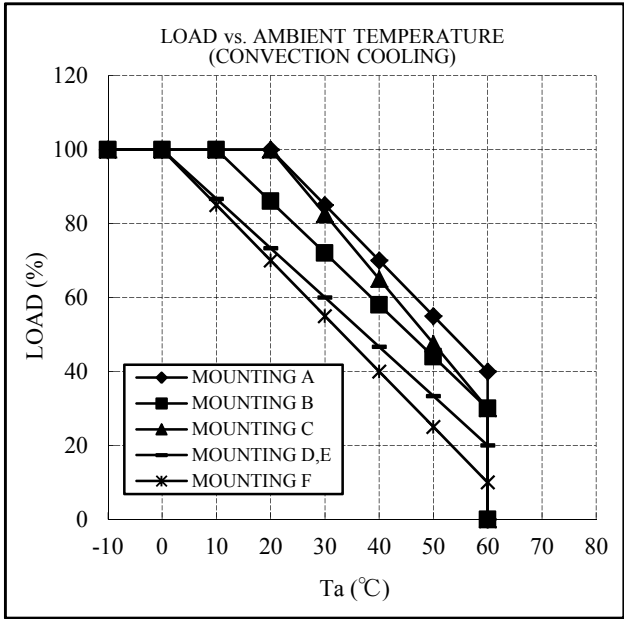

- MOUNTING A
- MOUNTING B
- MOUNTING C
- MOUNTING D
- MOUNTING E
- MOUNTING F

(STANDARD MOUNTING)

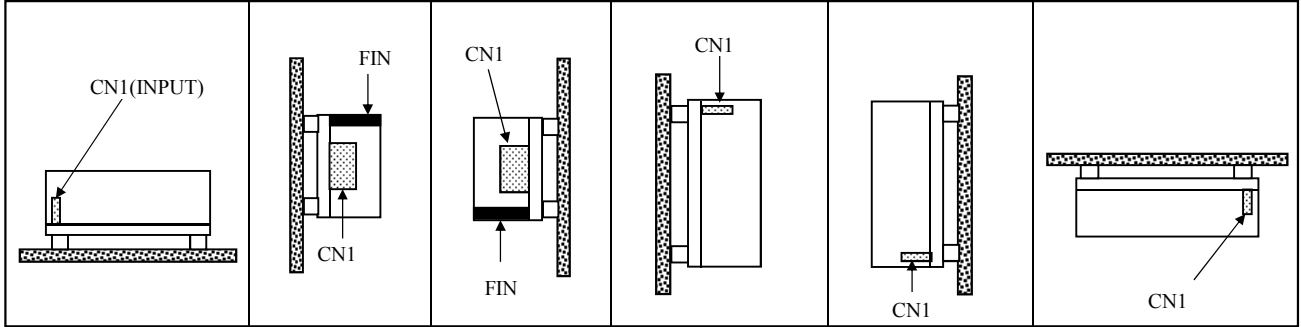

ZWS300BAF/A

OUTPUT DERATING (12V, 15V)

A254-01-08/A

*COOLING : FORCED AIR COOLING

Ta (°C)	LOAD (%)
	MOUNTING A-F
-10 - +40	100
60	60

Air velocity $\geq 1.4\text{m/s}$:

Air must flow through component side.

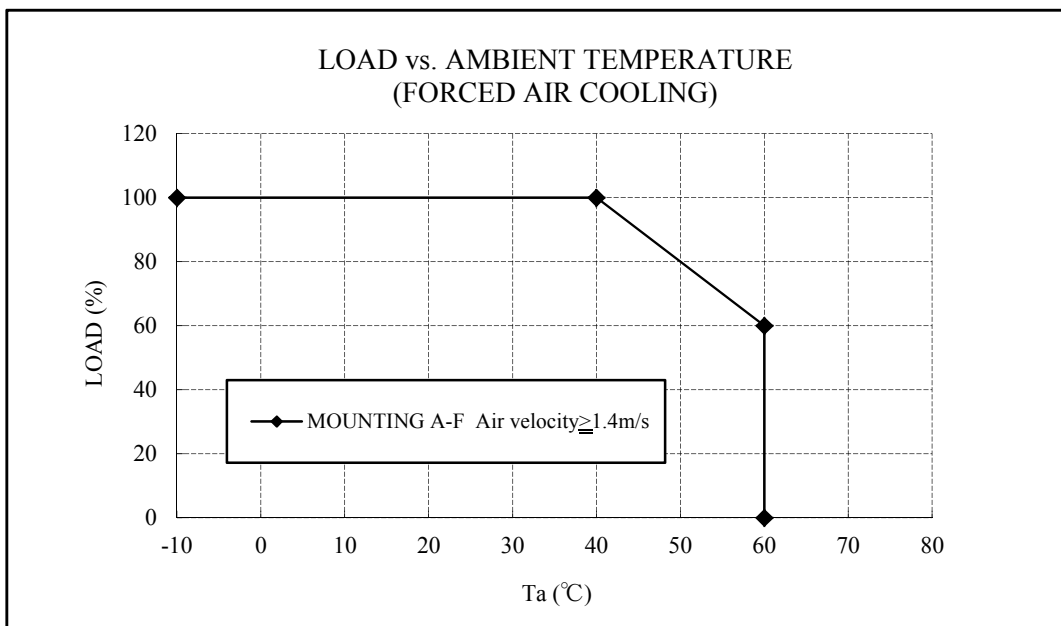

- MOUNTING A
- MOUNTING B
- MOUNTING C
- MOUNTING D
- MOUNTING E
- MOUNTING F

(STANDARD MOUNTING)

