

DETAILS

Product Number	CN12965_LENINA-XW
Family	Lenina
Type	RefPack
Color	white
Diameter	74 mm
Height	46,3 mm
Style	round
Optic Material	
Holder Material	
Fastening	socket
Status	production ready
ROHS Compliant	Yes
Date Updated	31/10/2016

OPTICAL PROPERTIES

LED	Viewing Angle	Light Beam	Efficiency	cd/lm	Connector
CLL04x/CLU04x	71 deg	WWW-class	89 %	0.600	-
CLU730/731	72 deg	WWW-class	94 %	0.660	-
LUXEON CoB 1216	73 deg	WWW-class	94 %	0.620	LEDiL: LEDiL
CXM-22	73 deg	WWW-class	94 %	0.600	-
ZC25/40	73 deg	WWW-class	89 %	0.600	-



Absolute intensity of CN12965_LENINA-XW

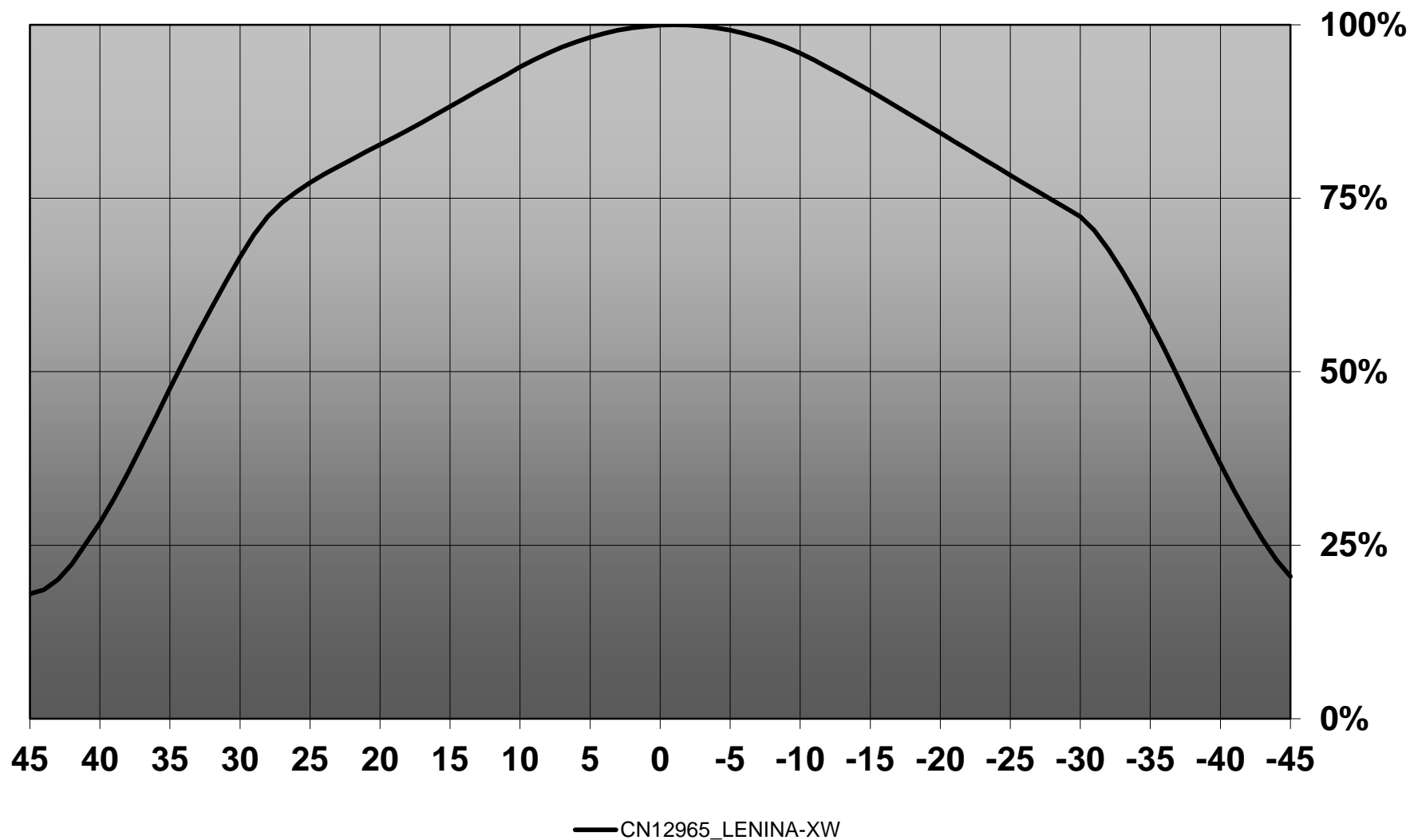

Relative intensity of CN12965_LENINA-XW_(CXM-22)

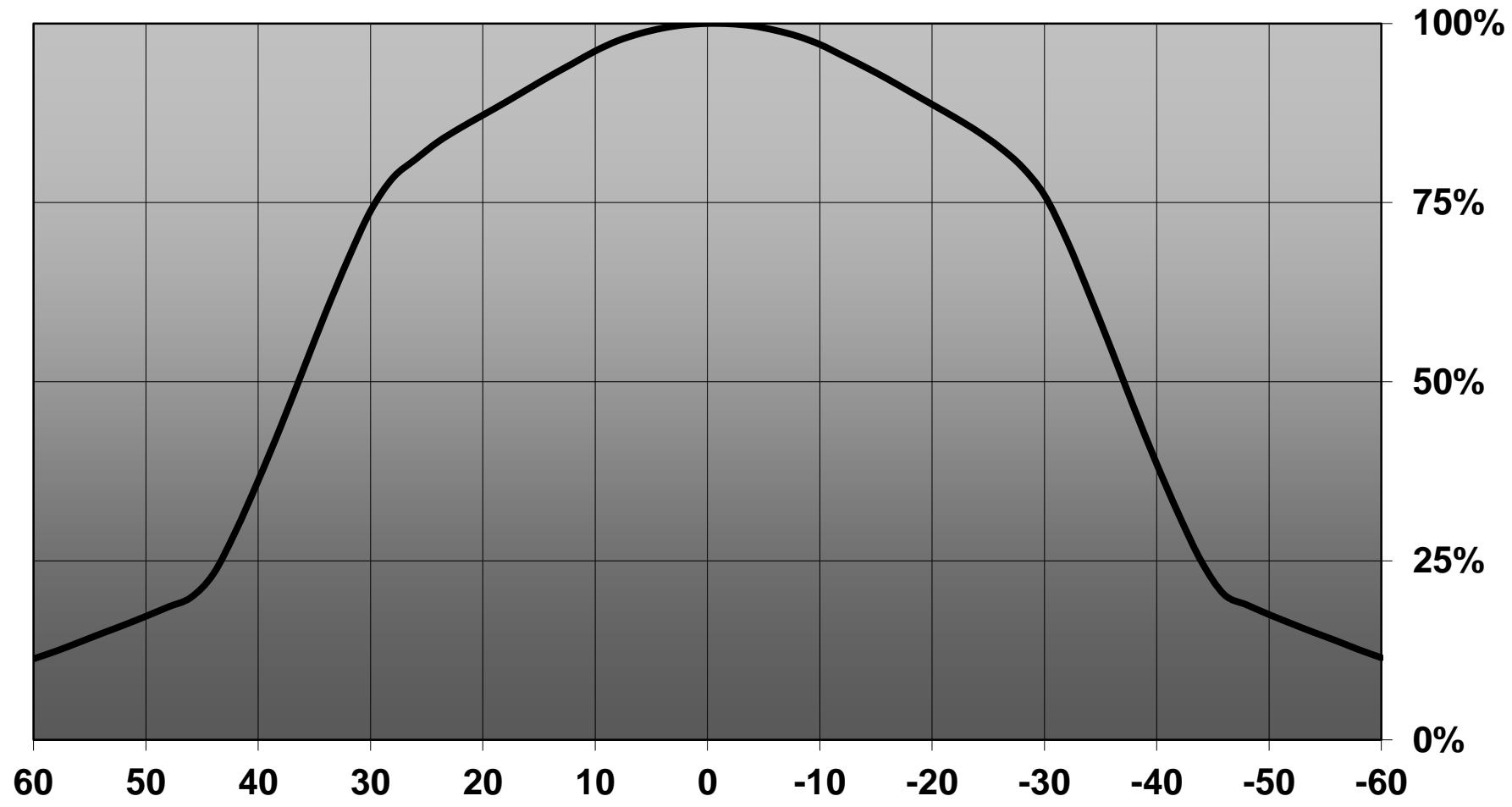

— 1: 0-180

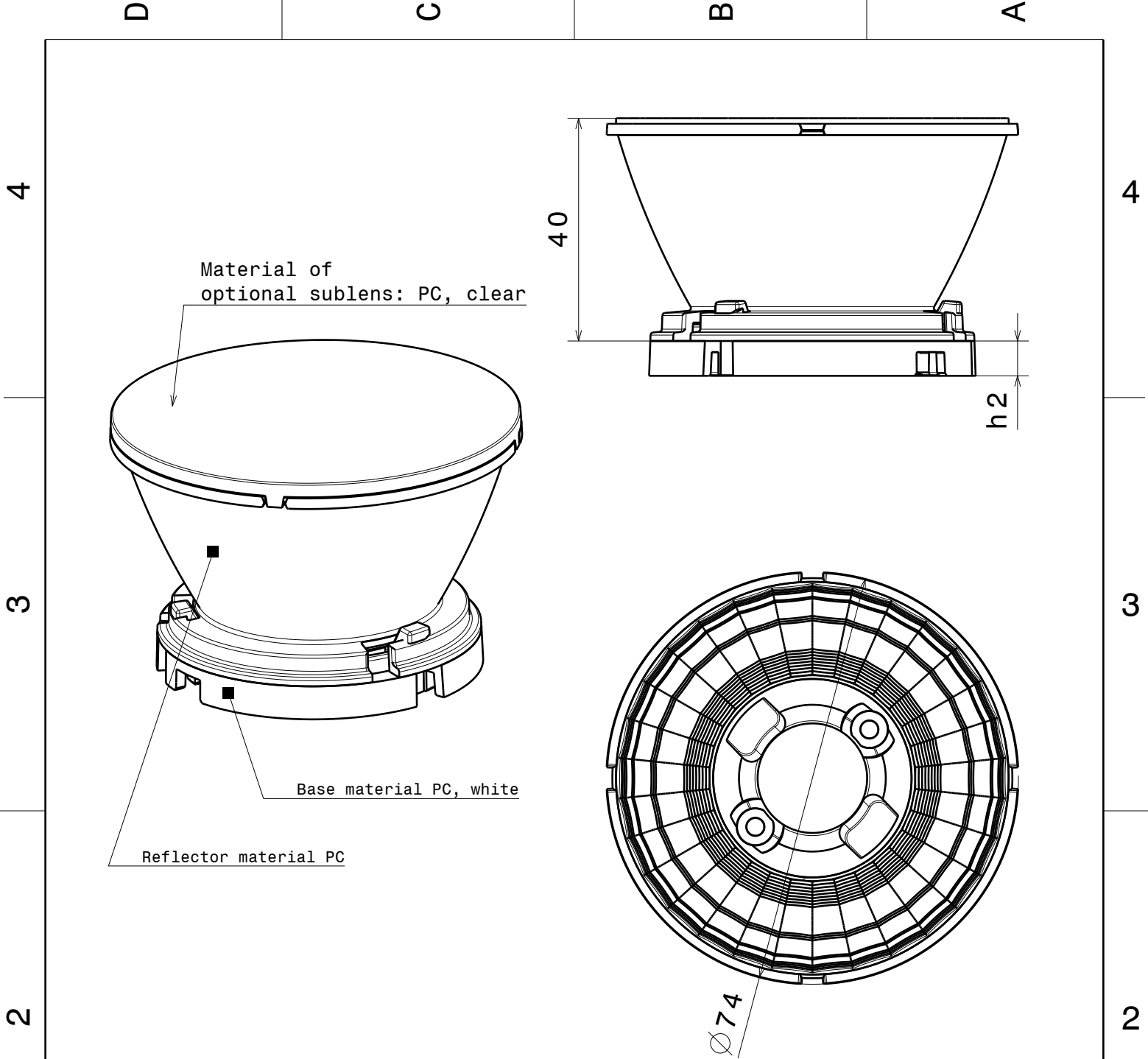

NOTE:

Using optional sublens, add 2.1mm to the system height

Dimension 'h2' varies from 4.5mm to 7mm depending on the LED specific base part

This drawing is our property. It can't be reproduced or communicated without our written agreement.



Ledil Oy
Salorankatu 10
FIN-24240 SALO
Finland

DRAWING TITLE

Datasheet Lenina series

DRAWN BY ks		DATE 23.04.2014		SIZE A4				DRAWING NUMBER --		REV 1	
CHECKED BY		DATE								SCALE 1:1	
DESIGNED BY pl		DATE 08.03.2012									

D

A

Luminaire: LEDIL OY CN12965_LENINA-XW Eff.88.8%
Lamps: 1 x CLL040 (897.6lm@250mA)

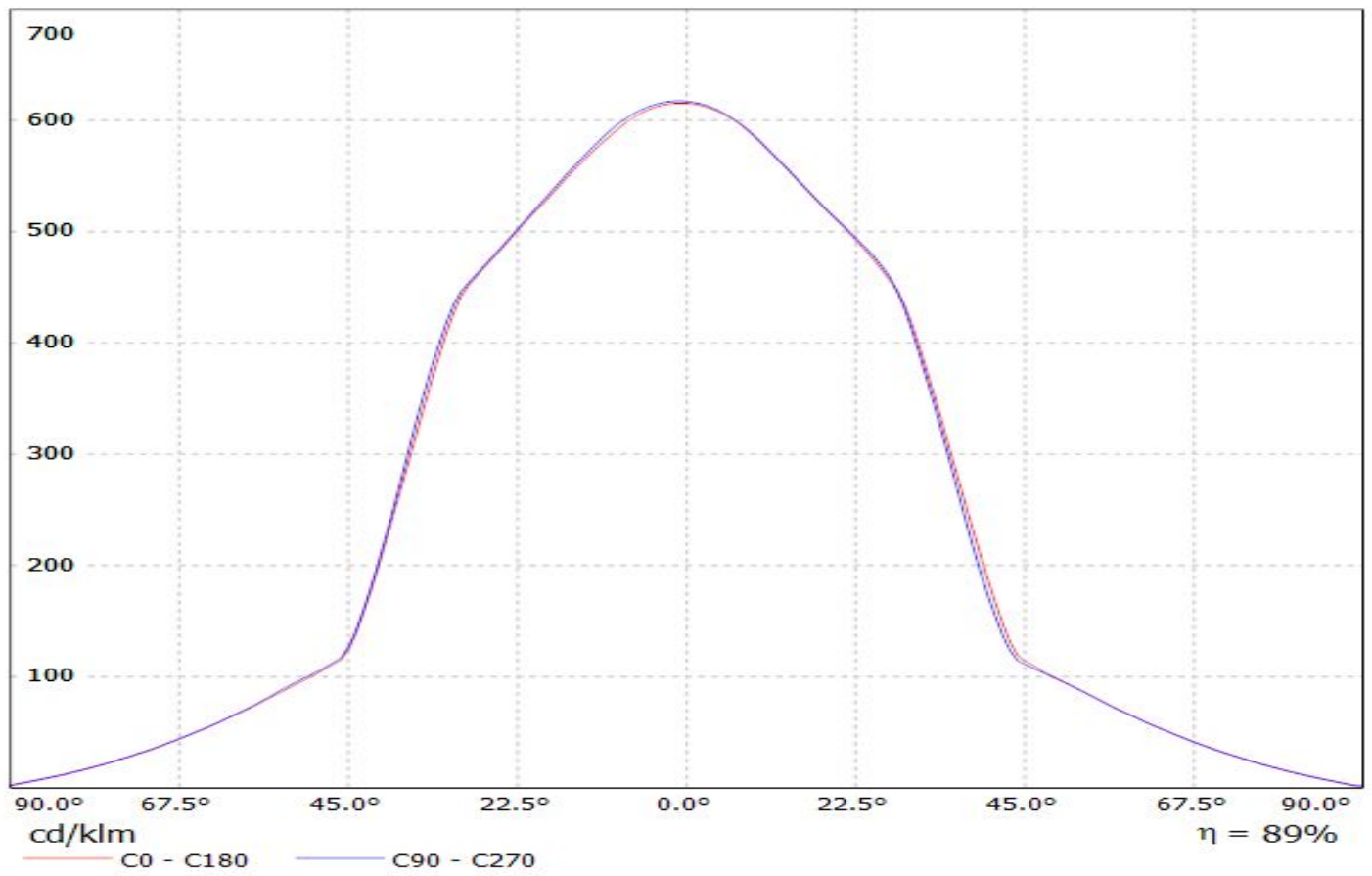

Luminaire: Ledil CN12965_LENINA-XW_(CLU730)

Lamps: 1 x CITIZEN_CLU730_(C12692_LENA-STD-BASE-CLL040)_1247.17lm@250mA_P=8.5W_I=0.25A

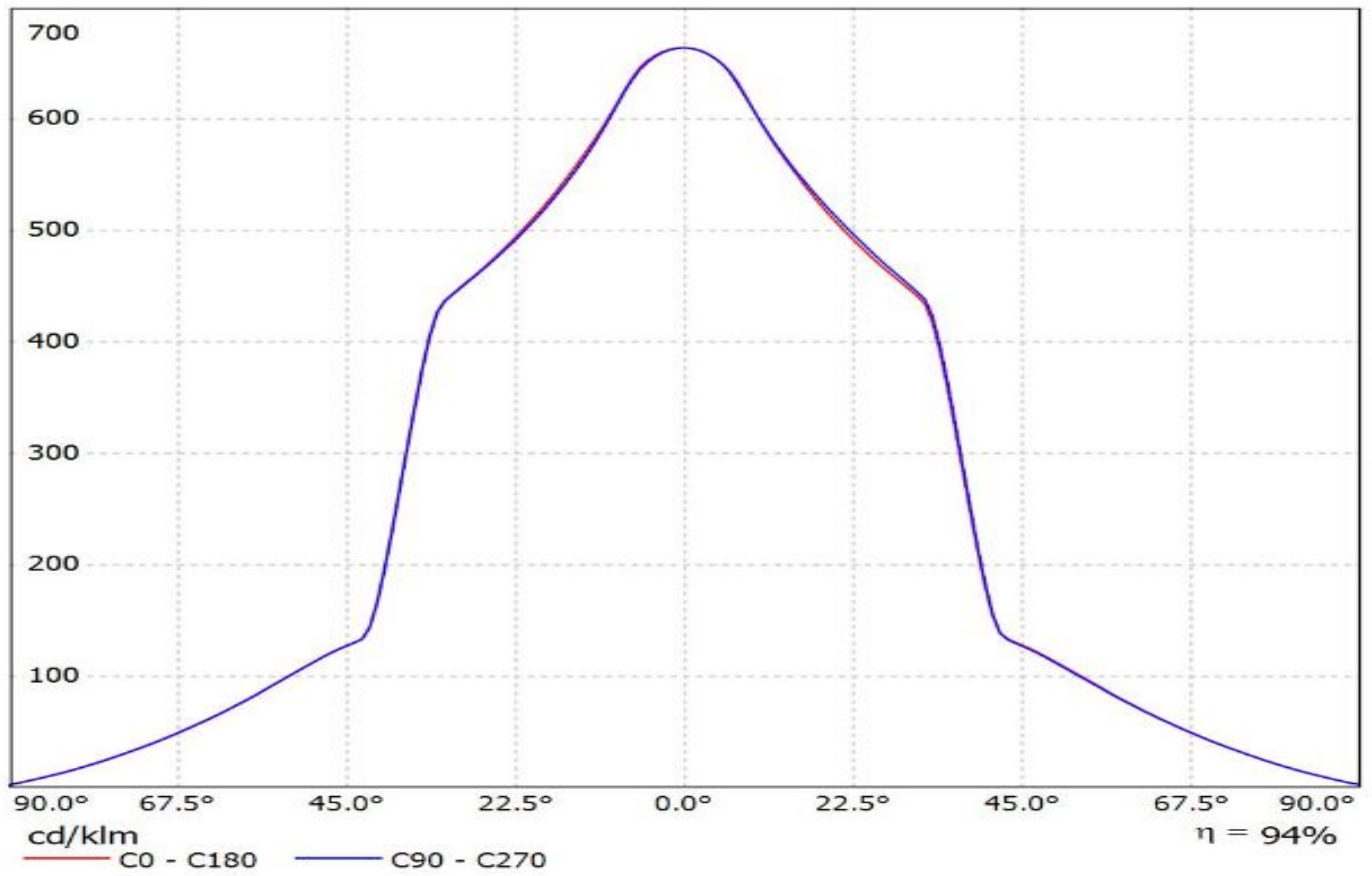

Luminaire: Ledil CN12965_LENINA-XW_(CoB_1216)

Lamps: 1 x Luxeon_CoB_1216_(L2C2-40801216E2300)_1399.08lm@250mA_P=8.00375W_I=0.25A

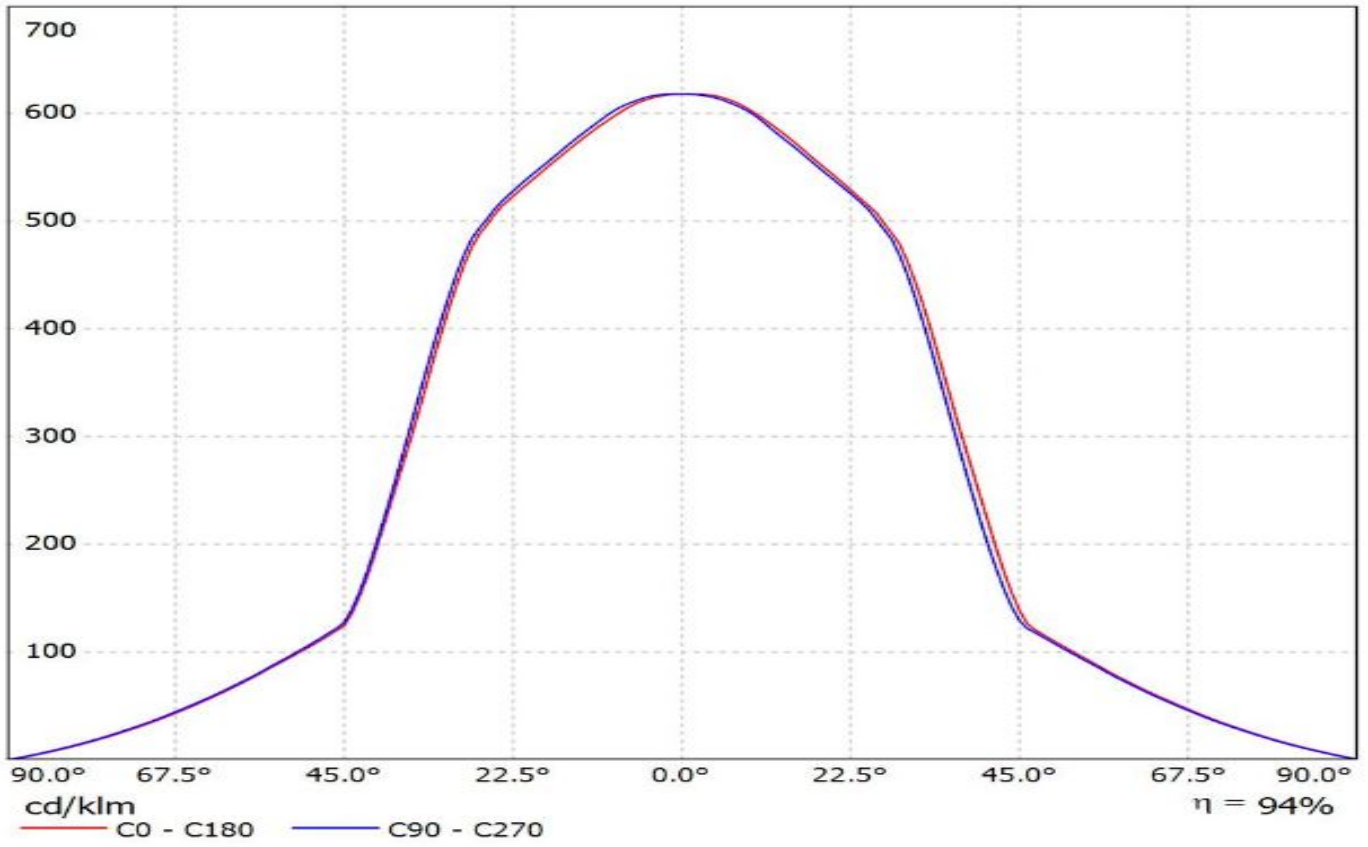

LEDiL Oy CN12965_LENINA-XW_(ZC-40) Eff.89.2% / LDC (Linear)

Luminaire: LEDiL Oy CN12965_LENINA-XW_(ZC-40) Eff.89.2%
Lamps: 1 x SEOUL_ZC-40 (1233.37lm@250mA)

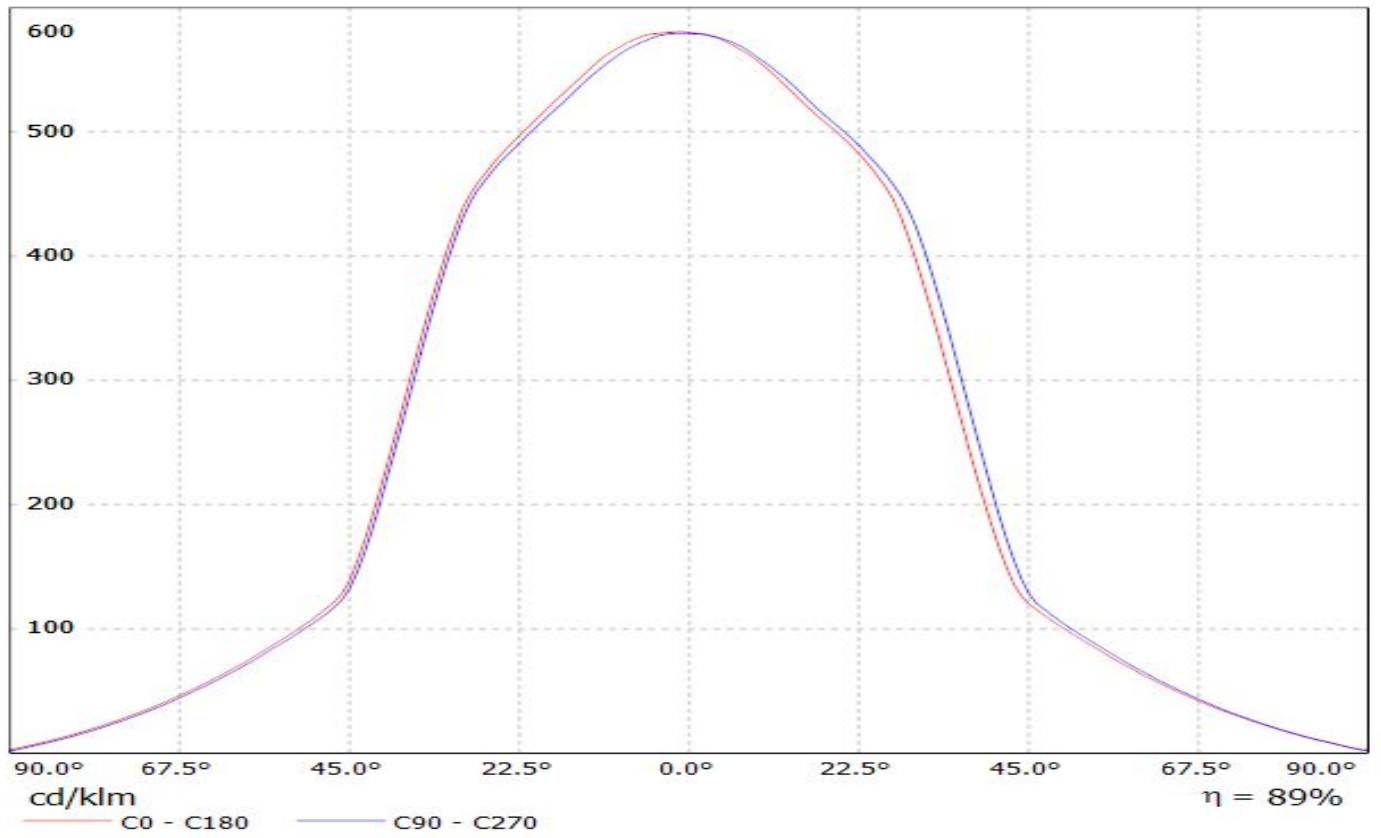

Luminaire: LEDIL OY CN12965_LENINA-XW Eff.88.8%
Lamps: 1 x CLL040 (897.6lm@250mA)

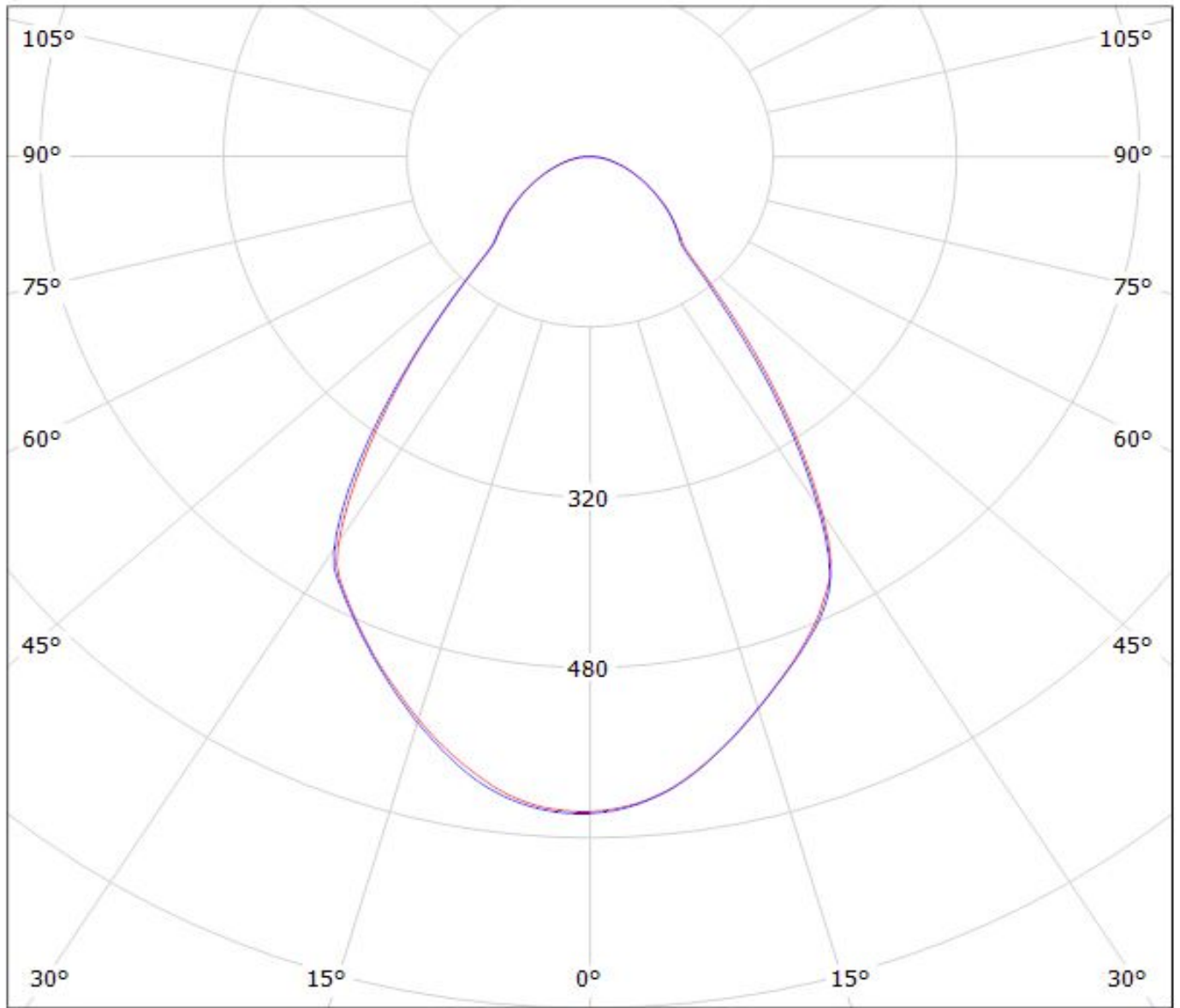

cd/klm

— C0 - C180 — C90 - C270

$\eta = 89\%$

Luminaire: Ledil CN12965_LENINA-XW_(CLU730)

Lamps: 1 x CITIZEN_CLU730_(C12692_LENINA-STD-BASE-CLL040)_1247.17lm@250mA_P=8.5W_I=0.25A

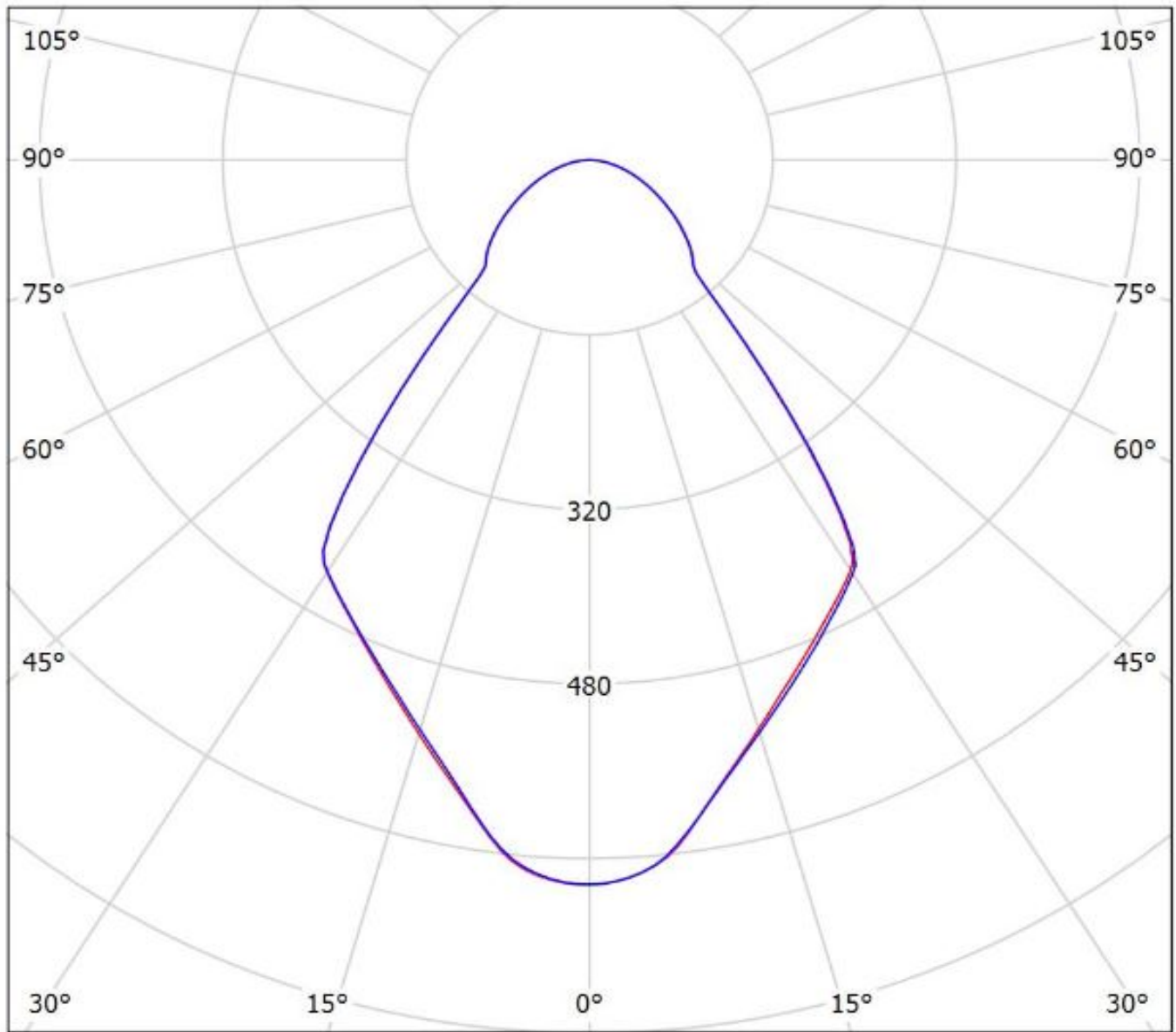

cd/klm

— C0 - C180 — C90 - C270

$\eta = 94\%$

Luminaire: Ledil CN12965_LENINA-XW_(CoB_1216)

Lamps: 1 x Luxeon_CoB_1216_(L2C2-40801216E2300)_1399.08lm@250mA_P=8.00375W_I=0.25A

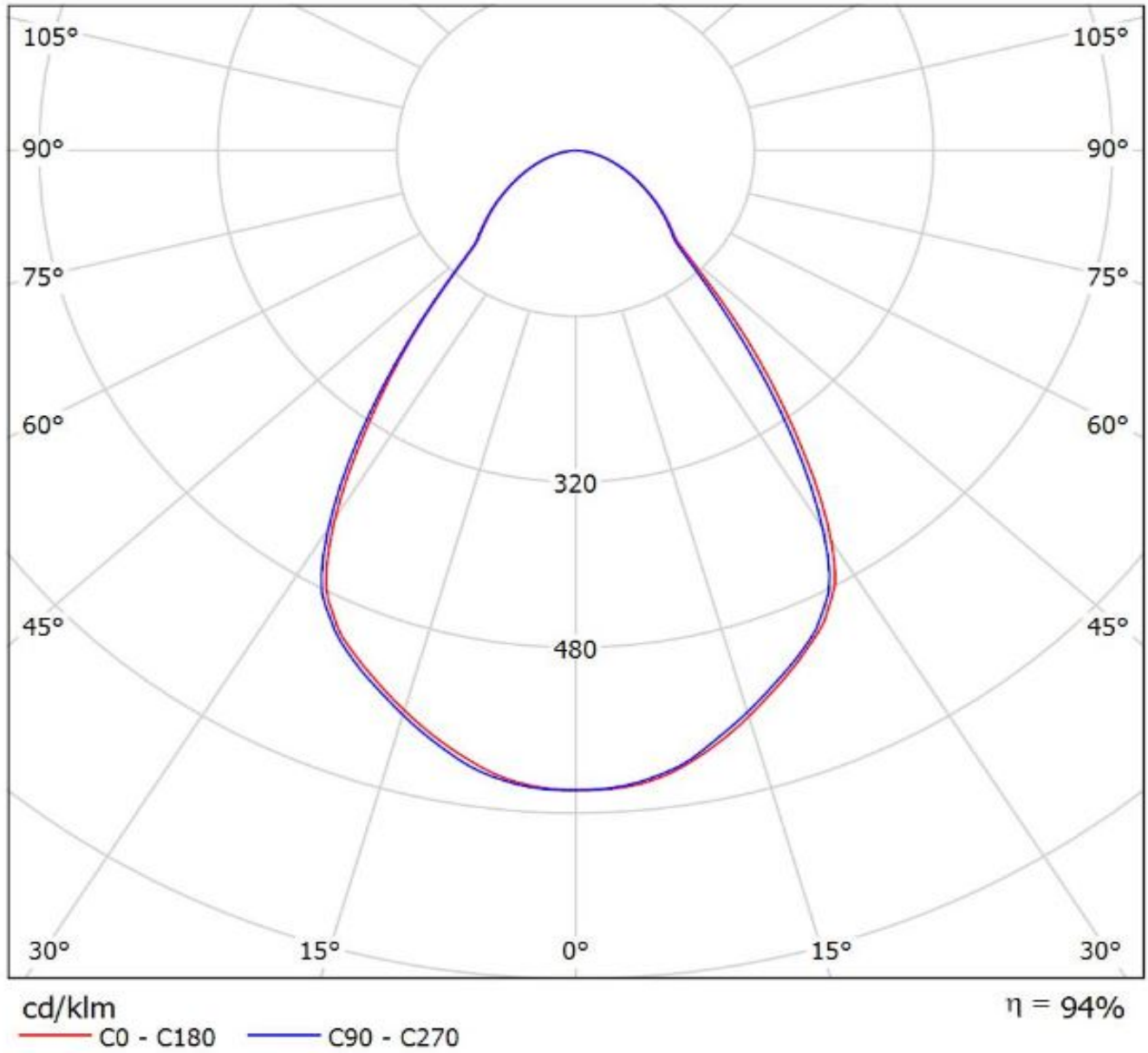

LEDiL Oy CN12965_LENINA-XW_(ZC-40) Eff.89.2% / LDC (Polar)

Luminaire: LEDiL Oy CN12965_LENINA-XW_(ZC-40) Eff.89.2%

Lamps: 1 x SEOUL_ZC-40 (1233.37lm@250mA)

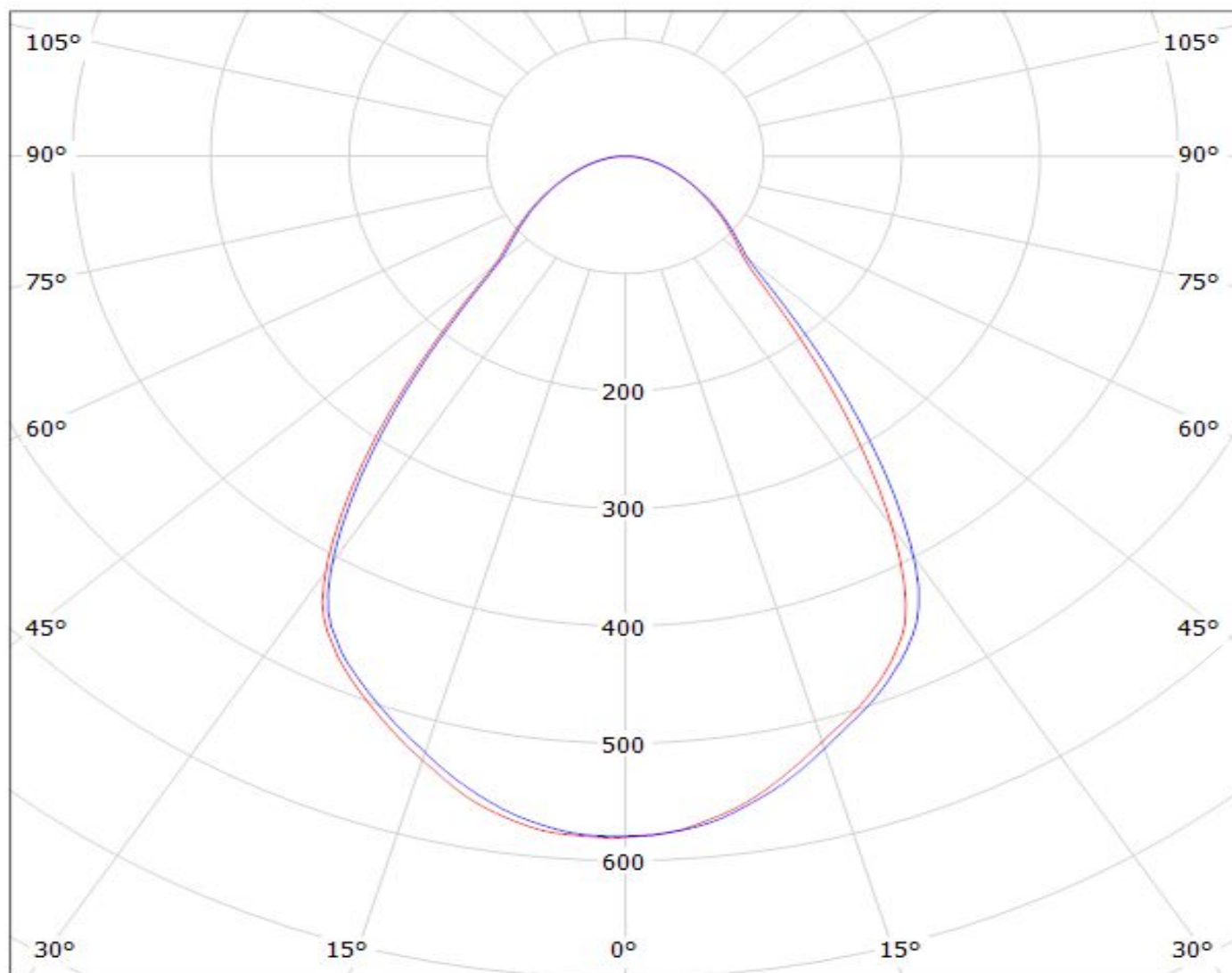

cd/klm

— C0 - C180 — C90 - C270

$\eta = 89\%$

NOTE: The typical divergence will be changed by different color, chip size and chip position tolerance. The typical total divergence is the full angle measured where the luminous intensity is half of the peak value.

GENERAL INFORMATION

- Product series especially designed & optimized for series of LEDs.
- Special care taken to make light distribution as uniform as possible.

Note! Due to use of high power COB's with this product, special attention to proper thermal design is highly recommended. LEDiL has no liability for direct, indirect or consecutive damages arising from the LEDiL products being used outside of the recommended temperature range.