

# NPN Silicon Phototransistor

## OP505, OP506, OP535 & OP705 Series



### Features:

- T-1 package style
- Variety of sensitivity ranges
- Choice of narrow or wide receiving angle
- Small package size ideal for space-limited applications
- 0.050" [1.27mm] or 0.100" [2.54mm] Lead spacing

### Description:

Each **OP505** and **OP506** devices consist of an NPN silicon phototransistor, the **OP535** device consist of an NPN silicon photodarlington transistor and the **OP705** device consist of an NPN silicon phototransistor with a large value resistor integrated between the Base and Emitter for low light signal rejection. All of the devices are molded in a blue-tinted T-1 (3mm) epoxy package

The **OP505**, **OP535** and **OP705** devices have a narrow receiving angle (typically 25°) that provides excellent on-axis coupling while the **OP506** device has a wider receiving angle (typically 60°) for those applications where a narrow receiving angle of the **OP505**, **OP535** and **OP705** is not required. The **OP505W** and **OP506W** device have the widest receiving angle (typically 90°) and provides relatively even reception over a large area.

Devices are 100% production tested, using infrared light for close correlation with Optek’s GaAs and GaAlAs emitters.

*Please refer to Application Bulletins 208 and 210 for additional design information and reliability (degradation) data.*

Please see your OPTEK representative for custom versions of these devices.

### Applications:

- Space-limited applications
- Interruptive applications to detect media which is semi-transparent to infrared light

Ordering Information				
Part Number	Sensor	Viewing Angle	Lead Spacing	Lead Length
OP505A	Transistor	25°	0.050" [1.27 mm]	0.50" [12.7 mm] (all devices in series)
OP505B				
OP505C				
OP505D				
OP505W		90°		
OP506A		60°	0.100" [2.54 mm]	
OP506B				
OP506C				
OP506W				
OP535A	Darlington R <sub>BE</sub> Transistor	25°	0.050" [1.27 mm]	
OP535B				
OP705A				



RoHS

General Note  
TT Electronics reserves the right to make changes in product specification without notice or liability. All information is subject to TT Electronics’ own data and is considered accurate at time of going to print.

OPTEK Technology, Inc.  
1645 Wallace Drive, Carrollton, TX 75006 | Ph: +1 972 323 2200  
www.optekinc.com | www.ttelectronics.com

# NPN Silicon Phototransistor

OP505, OP506, OP535 & OP705 Series



## OP505, OP535 & OP705 (A, B, C, D)

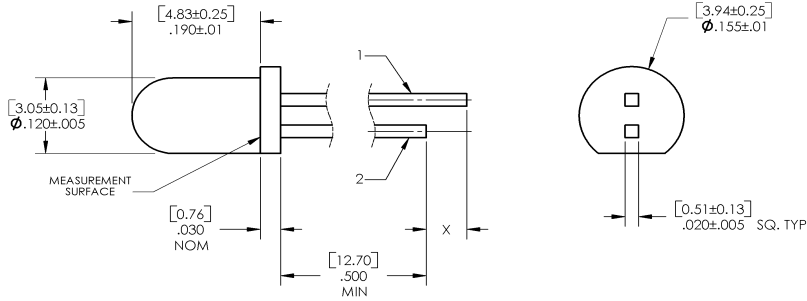

Pin #	Transistor
1	Emitter
2	Collector

## OP505, OP506 OP505W, OP506W

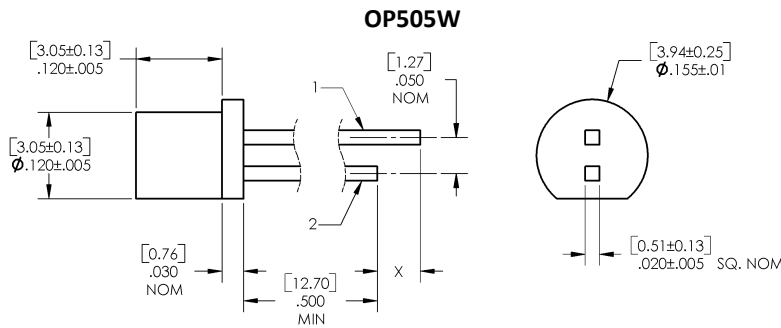
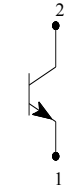

## OP705

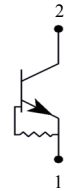

## OP506 (A, B, C)

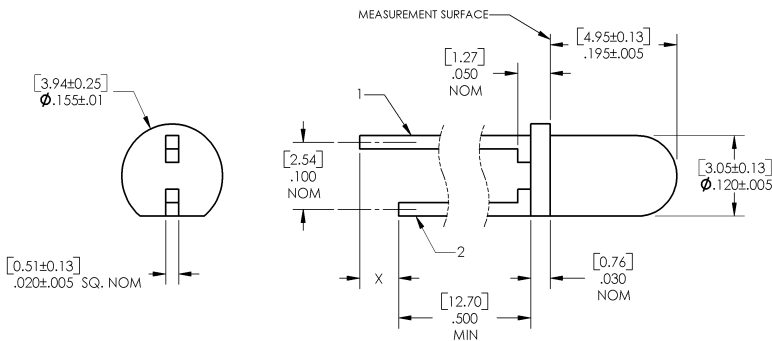

## OP535

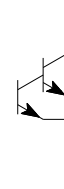

## OP506W

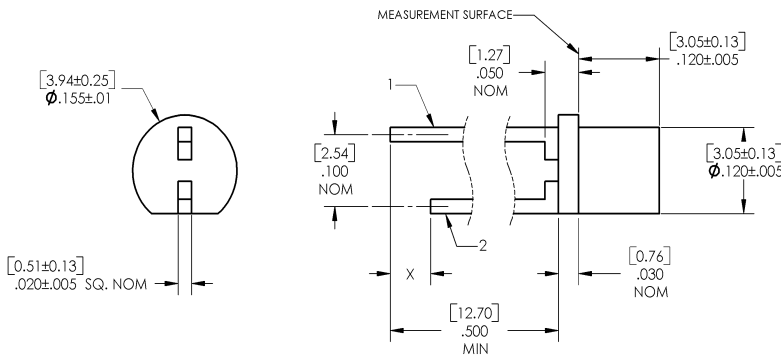

DIMENSIONS ARE IN: [MILLIMETERS]  
INCHES

**CONTAINS POLYSULFONE**  
To avoid stress cracking, we suggest using ND Industries' **Vibra-Tite** for thread-locking. **Vibra-Tite** evaporates fast without causing structural failure in OPTEK'S molded plastics.

### General Note

TT Electronics reserves the right to make changes in product specification without notice or liability. All information is subject to TT Electronics' own data and is considered accurate at time of going to print.

# NPN Silicon Phototransistor

OP505, OP506, OP535 & OP705 Series



## Electrical Specifications

Absolute Maximum Ratings ( $T_A = 25^\circ\text{C}$ unless otherwise noted)	
Storage & Operating Temperature Range	-40°C to +100°C
Collector-Emitter Voltage	30 V
Emitter-Collector Voltage (OP505 and OP506 series only)	5.0 V
Lead Soldering Temperature (1/16 inch (1.6 mm) from case for 5 seconds with soldering iron)	260°C
Power Dissipation	100 mW <sup>(2)</sup>
Emitter Reverse Current (OP705 series only)	10 mA
Collector DC Current (OP705 series only)	30 mA

Electrical Characteristics ( $T_A = 25^\circ\text{C}$ unless otherwise noted) OP505, OP506, OP705 Series						
SYMBOL	PARAMETER	MIN	TYP	MAX	UNITS	TEST CONDITIONS
$I_{C(ON)}$	On-State Collector Current OP505A, OP506A	4.30	-	-	mA	$V_{CE} = 5\text{ V}$ , $E_e = 0.50\text{ mW/cm}^2$ <sup>(3)</sup>
	OP705A	3.95	-	12.00		
$I_{C(ON)}$	OP505B, OP506B	2.15	-	5.95	mA	$V_{CE} = 5\text{ V}$ , $E_e = 0.13\text{ mW/cm}^2$ <sup>(3)</sup>
	OP505C, OP506C	1.10	-	3.00		
	OP505D	0.55	-	-		
$I_{CEO}$	Collector-Dark Current	-	-	100	nA	$V_{CE} = 10\text{ V}$ , $E_e = 0$ <sup>(4)</sup>
$V_{(BR)CEO}$	Collector-Emitter Breakdown Voltage OP505, OP505W, OP506, OP506W	30	-	-	V	$I_C = 100\ \mu\text{A}$
	OP705	24	-	-		
$V_{(BR)ECO}$	Emitter-Collector Breakdown Voltage	5	-	-	V	$I_E = 100\ \mu\text{A}$
$V_{CE(SAT)}$	Collector-Emitter Saturation Voltage	-	-	0.40	V	$I_C = 250\ \mu\text{A}$ , $E_e = 0.5\text{ mW/cm}^2$ <sup>(2)</sup>
$\Delta I_C/\Delta T$	Relative $I_C$ Changes with Temperature	-	1.00	-	%/°C	$V_{CE} = 5\text{ V}$ , $E_e = 1.0\text{ mW/cm}^2$
$E_{KP}$	Knee Point Irradiance OP705	-	0.02	-	mW/cm <sup>2</sup>	$V_{CE} = 5\text{ V}$ <sup>(5)</sup>
$I_{CEO}$	Collector-Emitter Dark Current	-	-	100	nA	$V_{CE} = 10\text{ V}$ , $E_e = 0$
$I_{ECO}$	Emitter-Collector Reverse Current	-	-	100	$\mu\text{A}$	$V_{CE} = 5\text{ V}$ , $E_e = 0$

**Notes:**

- (1) RMA flux is recommended. Duration can be extended to 10 seconds maximum when flow soldering. A maximum of 20 grams force may be applied to the leads when soldering.
- (2) Derate linearly 1.33 mW/°C above 25°C.
- (3) Light source is an unfiltered GaAs LED with a peak emission wavelength of 935 nm and a radiometric intensity level, which varies less than 10% over the entire lens surface of the phototransistor being tested.
- (4) For OP505, OP505W, OP506, OP506W and OP705, to calculate typical collector dark current in nA, use the formula  $I_{CEO} = 10^{(0.040T_A - 3.4)}$  where  $T_A$  is ambient temperature in °C.

**General Note**

TT Electronics reserves the right to make changes in product specification without notice or liability. All information is subject to TT Electronics' own data and is considered accurate at time of going to print.

OPTEK Technology, Inc.  
1645 Wallace Drive, Carrollton, TX 75006 | Ph: +1 972 323 2200  
www.optekinc.com | www.ttelectronics.com

# NPN Silicon Phototransistor

OP505, OP506, OP535 & OP705 Series



## Electrical Specifications

Electrical Characteristics ( $T_A = 25^\circ\text{C}$ unless otherwise noted)						
SYMBOL	PARAMETER	MIN	TYP	MAX	UNITS	TEST CONDITIONS
<b>Photodarlington (OP535)</b>						
$I_{C(ON)}$	On-State Collector Current OP535B OP535A	3.5 10.5	- -	32.0 -	mA	$V_{CE} = 5\text{ V}, E_E = 0.13\text{ mW/cm}^2$ <sup>(1)</sup>
$I_{CEO}$	Collector-Dark Current	-	-	100	nA	$V_{CE} = 10\text{ V}, E_E = 0$
$V_{(BR)CEO}$	Collector-Emitter Breakdown Voltage	15.0	-	-	V	$I_C = 1.0\text{ mA}, E_E = 0$
$V_{(BR)ECO}$	Emitter-Collector Breakdown Voltage	5.0	-	-	V	$I_E = 100\text{ }\mu\text{A}, E_E = 0$
$V_{CE(SAT)}$	Collector-Emitter Saturation Voltage	-	-	1.10	V	$I_C = 250\text{ }\mu\text{A}, E_E = 5\text{ mW/cm}^2$ <sup>(1)(2)</sup>

Notes:

- (1) Light source is an unfiltered GaAs LED with a peak emission wavelength of 935 nm and a radiometric intensity level, which varies less than 10% over the entire lens surface of the phototransistor being tested.

General Note

TT Electronics reserves the right to make changes in product specification without notice or liability. All information is subject to TT Electronics' own data and is considered accurate at time of going to print.

OPTEK Technology, Inc.  
1645 Wallace Drive, Carrollton, TX 75006 | Ph: +1 972 323 2200  
www.optekinc.com | www.ttelectronics.com

# NPN Silicon Phototransistor

OP505, OP506, OP535 & OP705 Series



## Performance

OP505A, OP505B, OP505C, OP505D

Typical Spectral Response

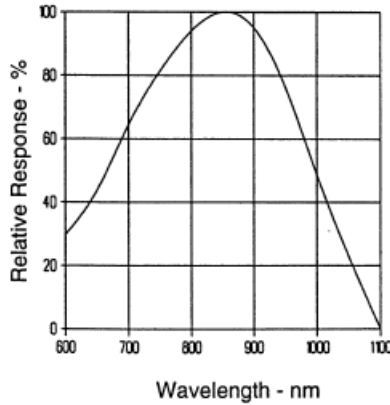

Coupling Characteristics  
OP165 and OP505

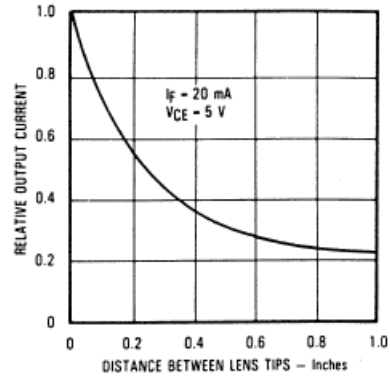

Normalized Collector Current  
vs. Angular Displacement

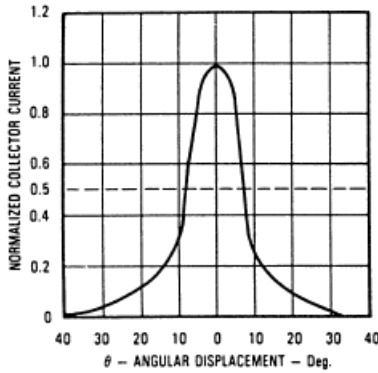

On-State Collector Current  
vs. Irradiance

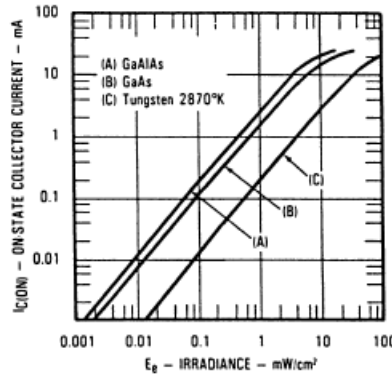

Normalized Collector Current vs.  
Collector to Emitter Voltage

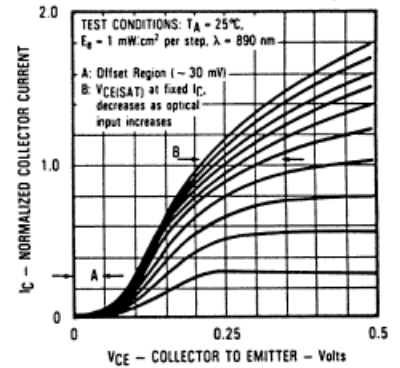

Rise and Fall Time  
vs. Load Resistance

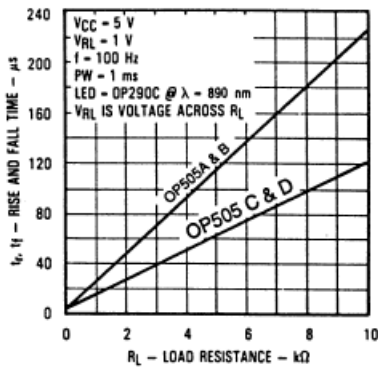

Normalized Output  
vs. Frequency

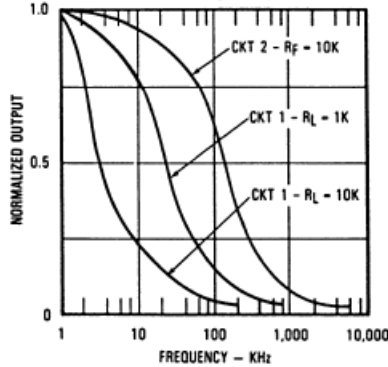

Switching Time  
Test Circuit

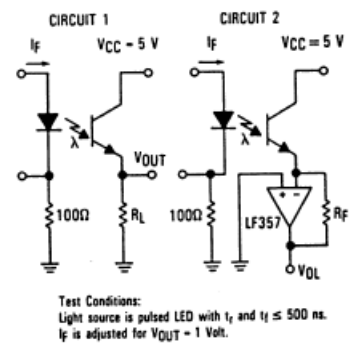

General Note

TT Electronics reserves the right to make changes in product specification without notice or liability. All information is subject to TT Electronics' own data and is considered accurate at time of going to print.

# NPN Silicon Phototransistor

OP505, OP506, OP535 & OP705 Series



## Performance

### OP505W

Typical Spectral Response

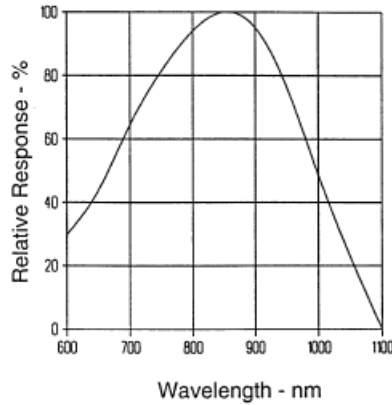

Coupling Characteristics of OP165W and OP505W

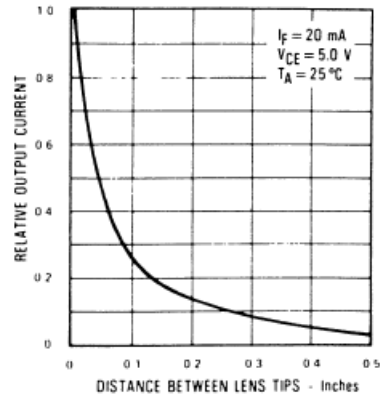

Normalized Collector Current vs. Angular Displacement

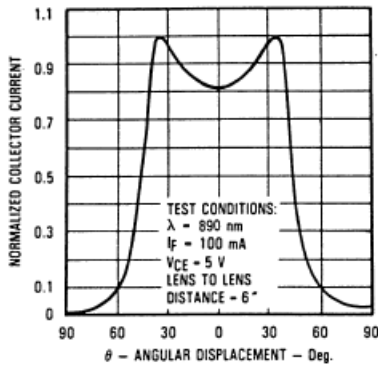

On-State Collector Current vs Irradiance

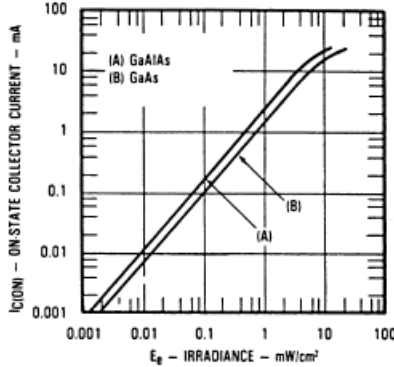

Normalized Collector Current vs. Collector to Emitter Voltage

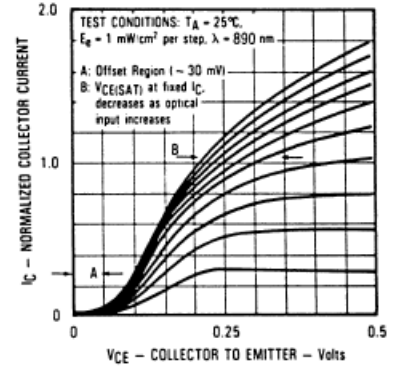

Rise and Fall Time vs. Load Resistance

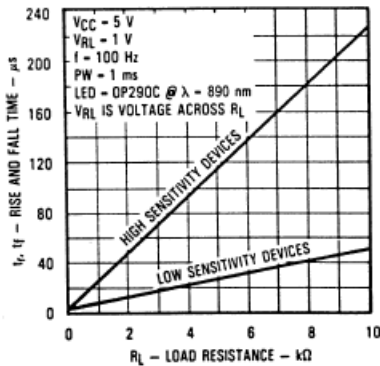

Normalized Output vs. Frequency

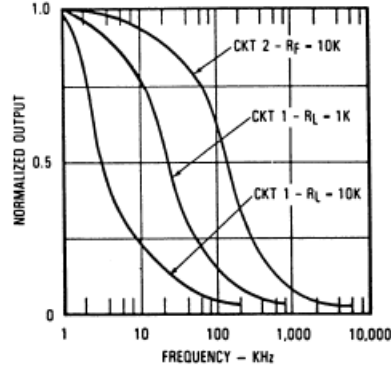

Switching Time Test Circuit

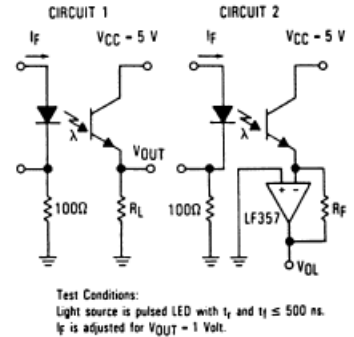

General Note

TT Electronics reserves the right to make changes in product specification without notice or liability. All information is subject to TT Electronics' own data and is considered accurate at time of going to print.

# NPN Silicon Phototransistor

OP505, OP506, OP535 & OP705 Series



## Performance

OP506A, OP506B, OP506C

Typical Spectral Response

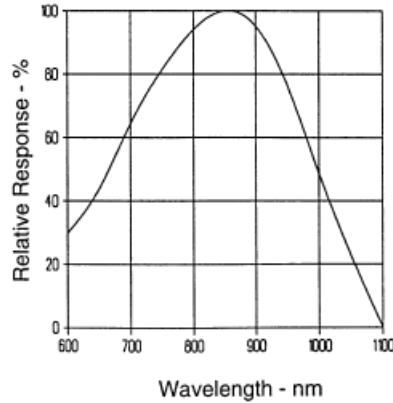

Coupling Characteristics of OP166 and OP506

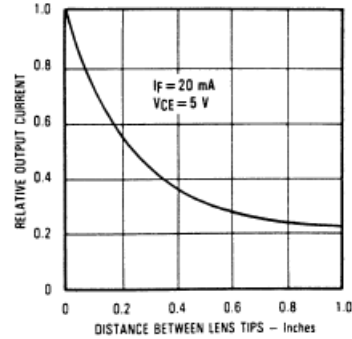

Normalized Collector Current vs Angular Displacement

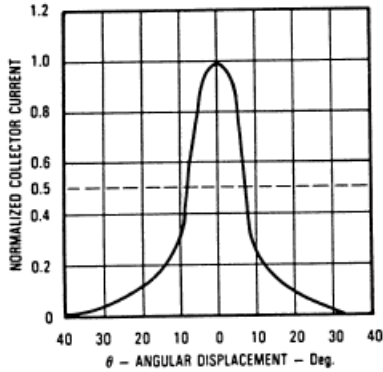

On-State Collector Current vs Irradiance

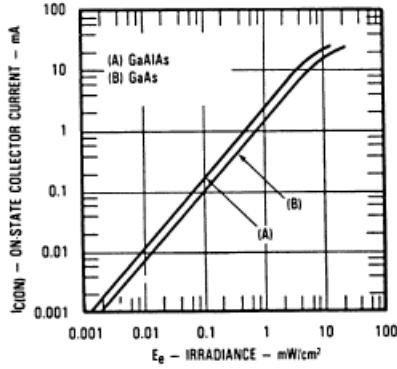

Normalized Collector Current vs Collector-to-Emitter Voltage

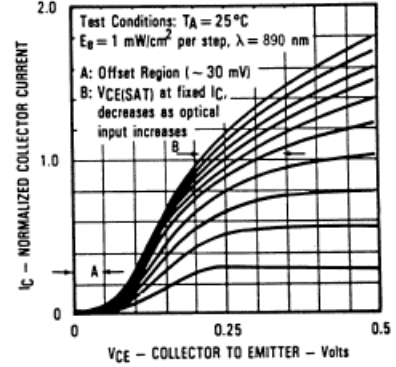

Rise and Fall Time vs Load Resistance

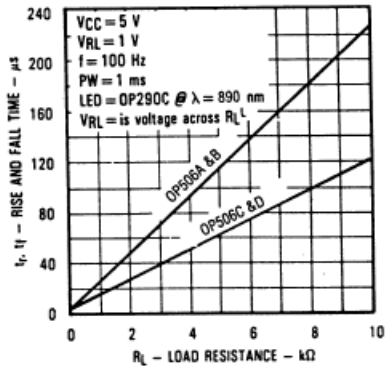

Normalized Output vs Frequency

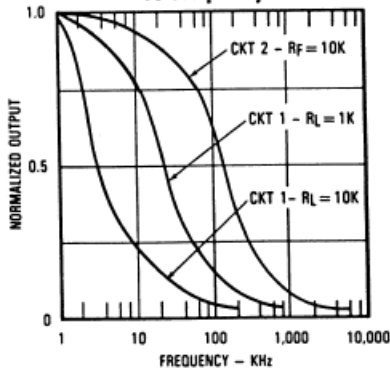

Switching Time Test Circuit

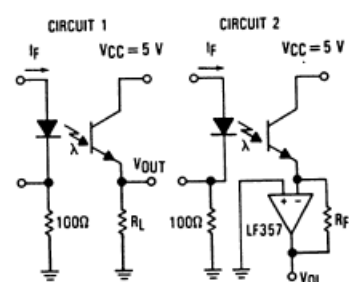

Test Conditions:  
Light source is pulsed LED with  $t_r$  and  $t_f \leq 500$  ns.  
 $I_f$  is adjusted for  $V_{OUT} = 1$  Volt.

General Note

TT Electronics reserves the right to make changes in product specification without notice or liability. All information is subject to TT Electronics' own data and is considered accurate at time of going to print.



# NPN Silicon Phototransistor

OP505, OP506, OP535 & OP705 Series



## Performance

### OP506W

Typical Spectral Response

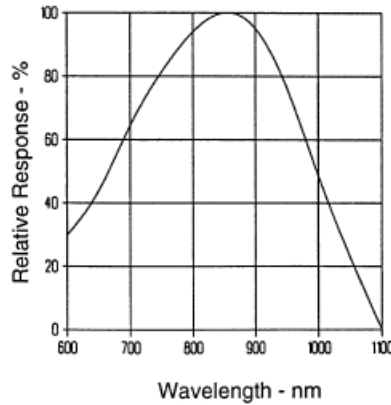

Coupling Characteristics

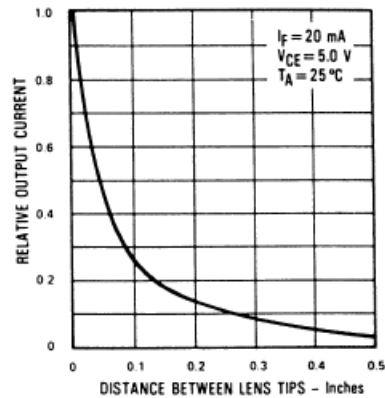

Normalized Collector Current vs. Angular Displacement

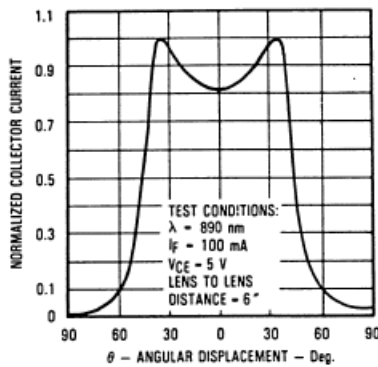

On-State Collector Current vs Irradiance

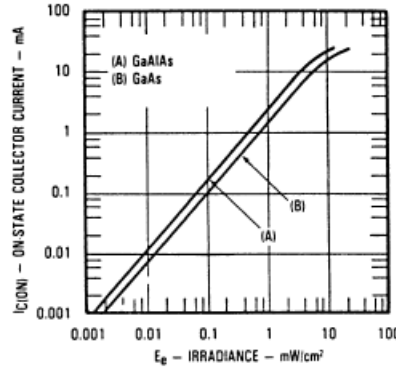

Normalized Collector Current vs Collector-to-Emitter Voltage

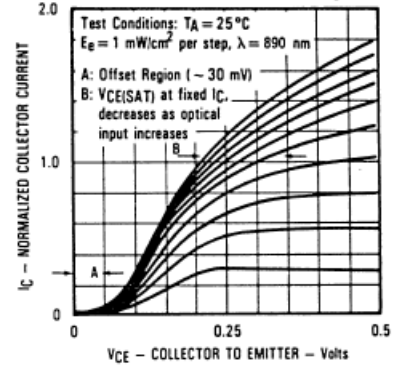

Rise and Fall Time vs Load Resistance

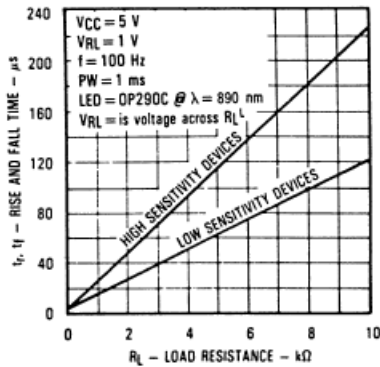

Normalized Output vs Frequency

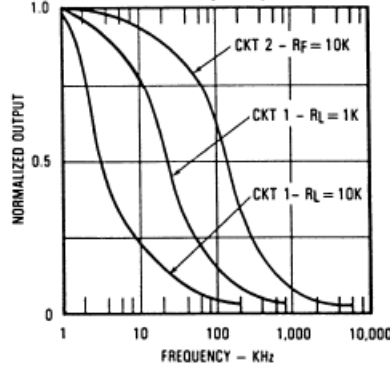

Switching Time Test Circuit

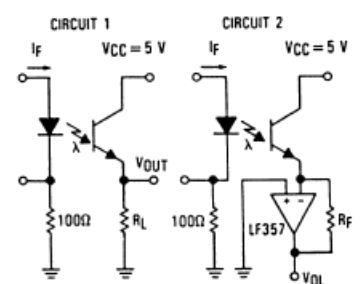

Test Conditions:  
Light source is pulsed LED with  $t_r$  and  $t_f \leq 500$  ns.  
 $I_f$  is adjusted for  $V_{OUT} = 1$  Volt.

General Note

TT Electronics reserves the right to make changes in product specification without notice or liability. All information is subject to TT Electronics' own data and is considered accurate at time of going to print.



# NPN Silicon Phototransistor

OP505, OP506, OP535 & OP705 Series



## Performance

OP535A, OP535B, OP535D

Typical Spectral Response

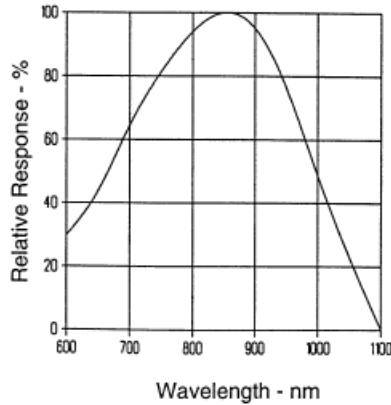

Coupling Characteristics of OP165 and OP535

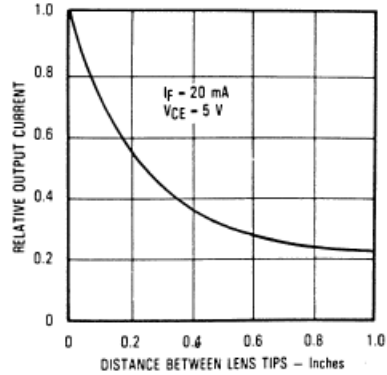

Collector Dark Current vs. Ambient Temperature

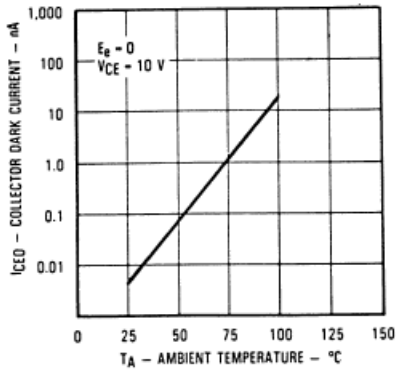

Collector Current vs. Ambient Temperature

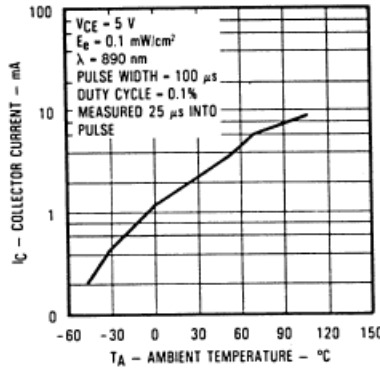

Collector Current vs. Irradiance

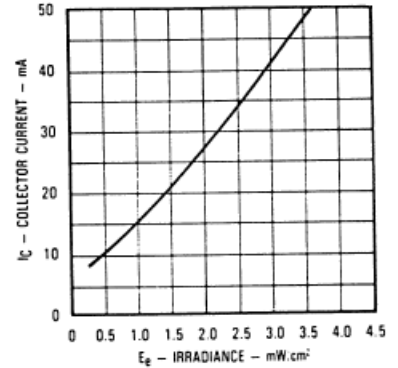

Rise and Fall Time vs. Load Resistance

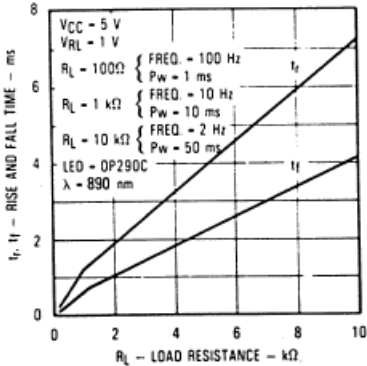

Normalized Collector Current vs. Angular Displacement

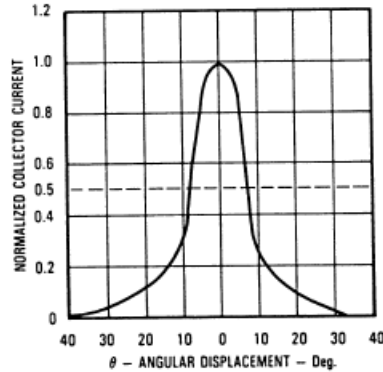

Switching Time Test Circuit

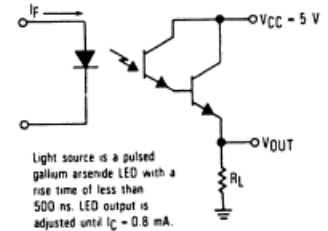

General Note

TT Electronics reserves the right to make changes in product specification without notice or liability. All information is subject to TT Electronics' own data and is considered accurate at time of going to print.

OPTEK Technology, Inc.  
1645 Wallace Drive, Carrollton, TX 75006 | Ph: +1 972 323 2200  
www.optekinc.com | www.ttelectronics.com

# NPN Silicon Phototransistor

OP505, OP506, OP535 & OP705 Series



## Performance

OP705A

Typical Spectral Response

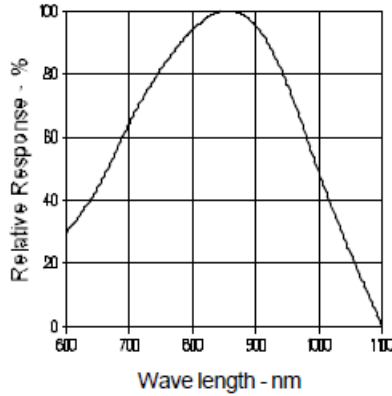

Schematic

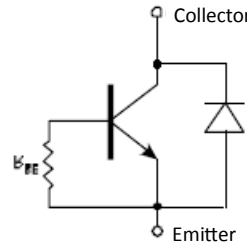

Normalized Collector Current vs. Angular Displacement

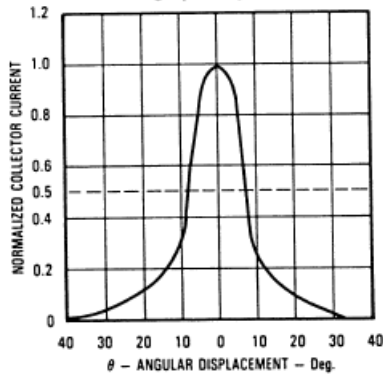

Normalized Light and Dark Current vs. Ambient Temperature

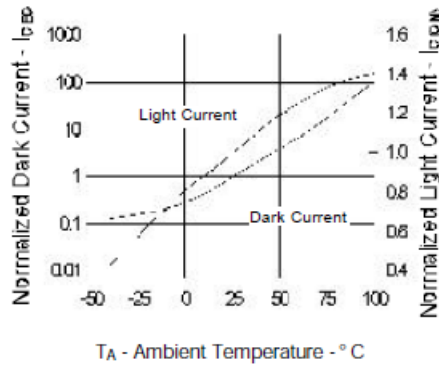

On-State Collector Current vs. Irradiance

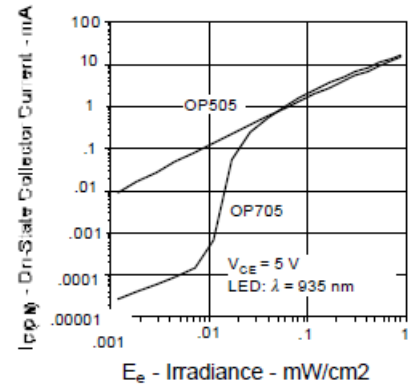

Normalized Output vs. Frequency

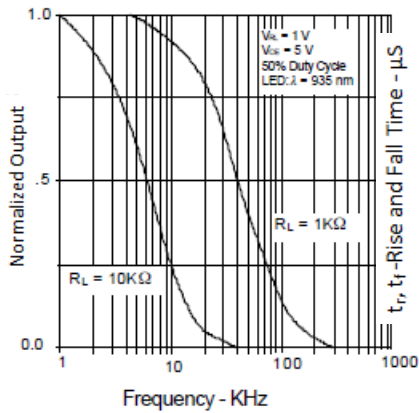

Typical Rise and Fall Time vs. Load Resistance

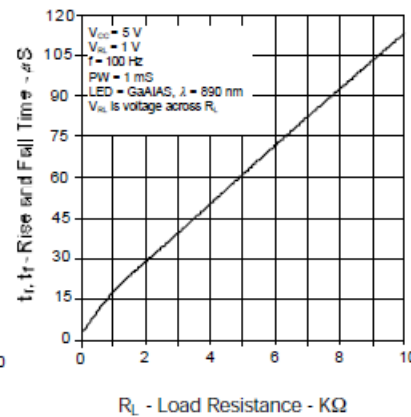

Switching Time Test Circuit

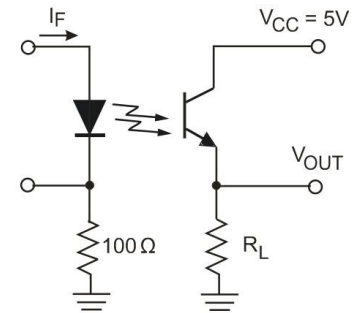

**Test Conditions:**  
Light Source is pulsed LED with  $t_r$  and  $t_f \leq 500\text{ns}$ .  
 $I_F$  is adjusted for  $V_{OUT} = 1\text{V}$ .

General Note  
TT Electronics reserves the right to make changes in product specification without notice or liability. All information is subject to TT Electronics' own data and is considered accurate at time of going to print.

OPTEK Technology, Inc.  
1645 Wallace Drive, Carrollton, TX 75006 | Ph: +1 972 323 2200  
www.optekinc.com | www.ttelectronics.com

