

PCB LAYOUT: COMPONENT SIDE
RECOMMEND PCB THICKNESS: .062/1.57

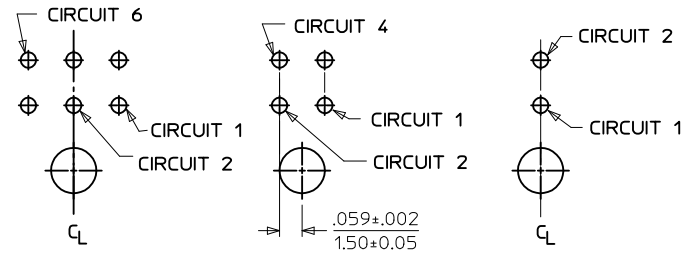

PCB LAYOUT: 6 CKT HEADER PCB LAYOUT: 4 CKT HEADER PCB LAYOUT: 2 CKT HEADER

CKTS	A	B	C
02	.262 6.65	NA	NA
04	.380 9.65	.118 3.00	NA
06	.498 12.65	.236 6.00	NA
08	.616 15.65	.354 9.00	.185 4.70
10	.734 18.65	.472 12.00	.303 7.70
12	.852 21.65	.591 15.00	.421 10.70
14	.970 24.65	.709 18.00	.539 13.70
16	1.088 27.65	.827 21.00	.657 16.70
18	1.206 30.65	.945 24.00	.776 19.70
20	1.325 33.65	1.063 27.00	.894 22.70
22	1.443 36.65	1.181 30.00	1.012 25.70
24	1.561 39.65	1.299 33.00	1.130 28.70

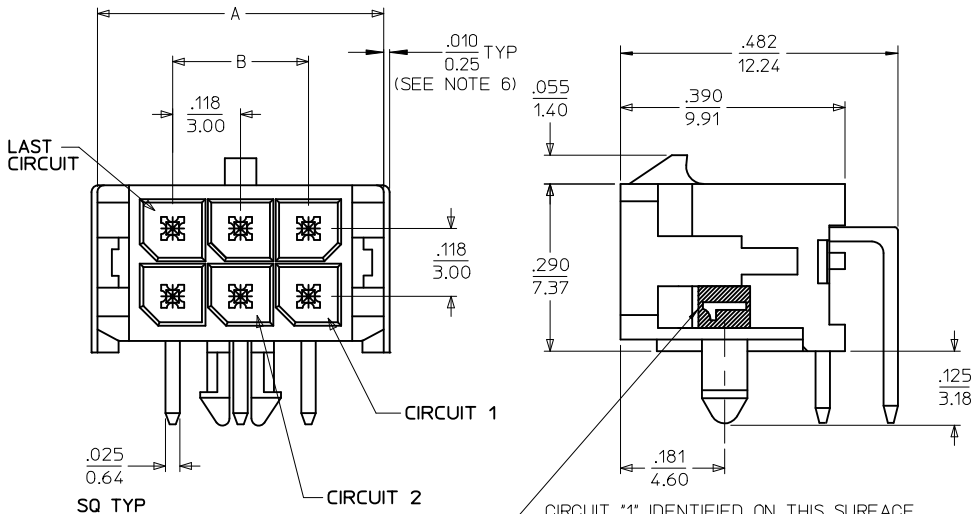

CIRCUIT "1" IDENTIFIED ON THIS SURFACE
(APPROX. LOCATION SHOWN FOR REF.)

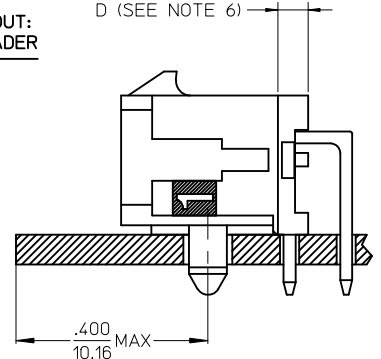

LOCATION DETAIL
SEE NOTE #7

NOTES:

- HOUSING MATERIAL: GLASS FILLED LIQUID CRYSTAL POLYMER, UL94V-0, COLOR: BLACK
TERMINAL MATERIAL: BRASS ALLOY
- FINISH: A = .000100/(0.00254) MIN. TIN OVER
.000050/(0.00127) MIN. NICKEL PLATE.
B = .000015/(0.00038) MIN. SELECT GOLD IN CONTACT AREA,
.000100/(0.00254) MIN. SELECT MATTE TIN ON SOLDER TAILS,
BOTH OVER .000050/(0.00127) MIN. NICKEL PLATE.
C = .000030/(0.00076) MIN. SELECT GOLD IN CONTACT AREA,
.000100/(0.00254) MIN. SELECT MATTE TIN ON SOLDER TAILS,
BOTH OVER .000050/(0.00127) MIN. NICKEL PLATE.
- PRODUCT SPECIFICATION: PS-43045
- TRAY PACKAGED : SEE MOLEX DRAWING PK-70873-0313
- MATES WITH MICRO FIT (3.0) RECEPTACLE SERIES 43025
- CIRCUIT SIZES 2-6: "D" IS .265/6.74 FOR .010/0.25 STEP.
CIRCUIT SIZES 8-24: "D" IS .063/1.60 FOR .010/0.25 STEP.
- TO AVOID INTERFERENCE BETWEEN RECEPTACLE AND PCB, HEADER MUST BE PLACED WITHIN .400/(10.16) MAX. FROM EDGE OF PCB, AS SHOWN IN LOCATION DETAIL.
- THIS PART CONFORMS TO CLASS B REQUIREMENTS OF PRODUCT SPECIFICATION PS-45499-002.

CKTS	FINISH A	FINISH B	FINISH C
	MATERIAL NO:	MATERIAL NO:	MATERIAL NO:
02	43045-0200	43045-0201	43045-0202
04	43045-0400	43045-0401	43045-0402
06	43045-0600	43045-0601	43045-0602
08	43045-0800	43045-0801	43045-0802
10	43045-1000	43045-1001	43045-1002
12	43045-1200	43045-1201	43045-1202
14	43045-1400	43045-1401	43045-1402
16	43045-1600	43045-1601	43045-1602
18	43045-1800	43045-1801	43045-1802
20	43045-2000	43045-2001	43045-2002
22	43045-2200	43045-2201	43045-2202
24	43045-2400	43045-2401	43045-2402

ADD 'D' DIM EC NO: UCP2011-0508 DRWNG:GIRANANI 2010/08/24 CHKD:SSOUSEK 2010/08/24 APPR:FSMITH 2010/12/23	QUALITY SYMBOLS ∇=0 ∇=0 ∇=0	GENERAL TOLERANCES (UNLESS SPECIFIED) mm INCH 4 PLACES ± --- ± --- 3 PLACES ± --- ± .010 2 PLACES ± 0.25 ± .014 1 PLACE ± 0.36 ± --- ANGULAR ±1/2°	DIMENSION STYLE IN/MM DRAWN BY: SAMIEC DATE: 2000/03/15 CHECKED BY: DATE: MUELLER 2000/03/15 APPROVED BY: DATE: EDGLEY 2000/03/15	SCALE --- DESIGN UNITS METRIC	THIRD ANGLE PROJECTION		
		DRAFT WHERE APPLICABLE MUST REMAIN WITHIN DIMENSIONS	MATERIAL NO. SEE CHART	TITLE MICRO-FIT (3.0) DUAL ROW RIGHT ANGLE THRU HOLE HEADER ASSY	MOLEX INCORPORATED	DOCUMENT NO. SD-43045-001	SHEET NO. 1 OF 1
		THIS DRAWING CONTAINS INFORMATION THAT IS PROPRIETARY TO MOLEX INCORPORATED AND SHOULD NOT BE USED WITHOUT WRITTEN PERMISSION					
		MOLEX INCORPORATED					

20 19 18 17 16 15 14 13 12 11 9 8 7 6 5 4 3 2 1

43045

MICRO-FIT(3.0)
DUAL-ROW SERIES

MICRO-FIT(3.0)
IN-LINE SERIES

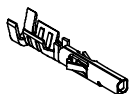

43030-xxxx
FEMALE CRIMP TERMINAL

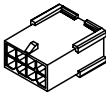

43020-xx01
PLUG W/O MTG. EARS

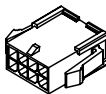

43020-xx00
PLUG W/ MTG. EARS

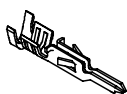

43031-xxxx
MALE CRIMP TERMINAL

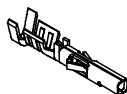

43030-xxxx
FEMALE CRIMP TERMINAL

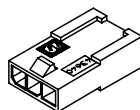

43640-xx01
PLUG W/O MTG. EARS

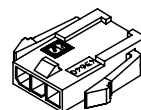

43640-xx00
PLUG W/ MTG. EARS

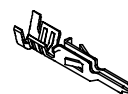

43031-xxxx
MALE CRIMP TERMINAL

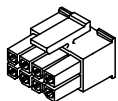

43025-xxxx
RECEPTACLE

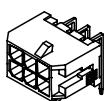

43045-xx00 THRU 43045-xx02
RIGHT ANGLE THRU HOLE
W/RETENTION PEG

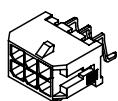

43045-xx03 THRU 43045-xx05
RIGHT ANGLE SURFACE MOUNT
W/RETENTION PEG

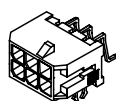

43045-xx06 THRU 43045-xx08
RIGHT ANGLE SURFACE MOUNT
W/RETENTION CLIP

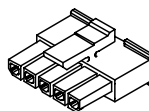

43645-xxxx
RECEPTACLE

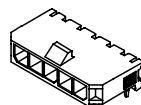

43650-xx00 THRU 43650-xx02
RIGHT ANGLE THRU HOLE
W/RETENTION PEG

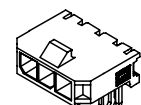

43650-xx03 THRU 43650-xx05
RIGHT ANGLE THRU HOLE
W/RETENTION CLIP

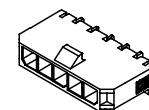

43650-xx06 THRU 43650-xx08
RIGHT ANGLE SURFACE MOUNT
W/RETENTION PEG

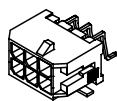

43045-xx09 THRU 43045-xx11
RIGHT ANGLE SURFACE MOUNT
W/FITTING NAIL

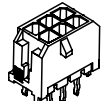

43045-xx12 THRU 43045-xx14
VERTICAL O.T.R. THRU HOLE

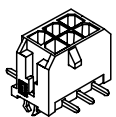

43045-xx15 THRU 43045-xx17
VERTICAL SURFACE MOUNT
W/RETENTION CLIP

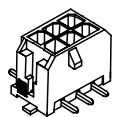

43045-xx18 THRU 43045-xx20
VERTICAL SURFACE MOUNT
W/FITTING NAIL

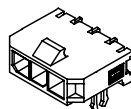

43650-xx09 THRU 43650-xx11
RIGHT ANGLE SURFACE MOUNT
W/RETENTION CLIP

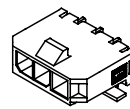

43650-xx12 THRU 43650-xx14
RIGHT ANGLE SURFACE MOUNT
W/FITTING NAIL

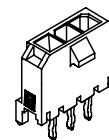

43650-xx15 THRU 43650-xx17
VERTICAL O.T.R. THRU HOLE

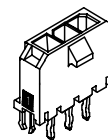

43650-xx18 THRU 43650-xx20
VERTICAL O.T.R. THRU HOLE
W/RETENTION CLIP

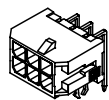

43045-xx21 THRU 43045-xx23
RIGHT ANGLE THRU HOLE
W/RETENTION CLIP

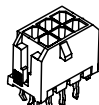

43045-xx24 THRU 43045-xx26
VERTICAL O.T.R. THRU HOLE
W/RETENTION CLIP

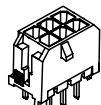

43045-xx27 THRU 43045-xx29
VERTICAL STRAIGHT PIN THRU HOLE

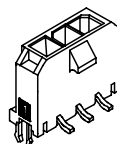

43650-xx21 THRU 43650-xx23
VERTICAL SURFACE MOUNT
W/RETENTION CLIP

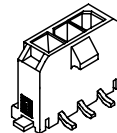

43650-xx24 THRU 43650-xx26
VERTICAL SURFACE MOUNT
W/FITTING NAIL

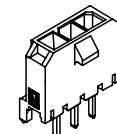

43650-xx27 THRU 43650-xx29
VERTICAL STRAIGHT PIN THRU HOLE

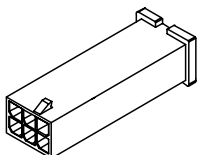

44242-0001 THRU 44242-0011
4-24 CKT. TEST PLUG

REVISED/REDRAWN EC NO. UCP2004-1223 DRWN: ICERNY 2004/03/12 CHKD: CHKDC 2004/03/31 APPR: FSMITH 2004/04/05	QUALITY SYMBOLS	GENERAL TOLERANCES (UNLESS SPECIFIED)		SCALE	DESIGN UNITS	THIRD ANGLE PROJECTION	REVISE ON CAD ONLY	
	▽ 0 ▽ 0	4 PLACES ± 0.15 3 PLACES ± 0.20 2 PLACES ± 0.25 1 PLACE ± 0.30	mm INCH ± 0.15 ± 0.005 ± 0.20 ± 0.008 ± 0.25 ± 0.010 ± 0.30 ± 0.013	DIMENSION STYLE IN/MM	DATE 1999/03/11	DATE 1999/03/11	TITLE MICRO-FIT (3.0) CONNECTOR FAMILY (INDEX DRAWING)	
		ANGULAR ±1/2°		DRAWN BY GUZIK	DATE 1999/03/11	CHECKED BY EDGLEY	DATE 1999/03/11	
		DRAFT WHERE APPLICABLE		APPROVED BY EDGLEY	DATE 1999/03/11	MATERIAL NO. SEE CHART	(DOCUMENT NO.) SDIN-43045-0001	SHEET NO. 1 OF 1
		MUST REMAIN WITHIN DIMENSIONS		THIS DRAWING CONTAINS INFORMATION THAT IS PROPRIETARY TO MOLEX INCORPORATED AND SHOULD NOT BE USED WITHOUT WRITTEN PERMISSION				