

COUNT	DESCRIPTION OF REVISIONS	BY	CHKD	DATE	COUNT	DESCRIPTION OF REVISIONS	BY	CHKD	DATE
1	RE-H-06193	I.D	H.U	'04.04.13					
2	RE-H-06617	I.D	T.M	'04.11.27					

MATED CONNECTORS

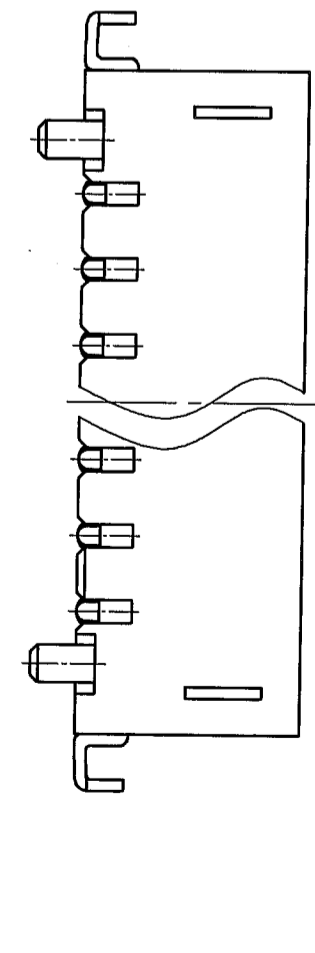

RECOMMENDED PATTERN

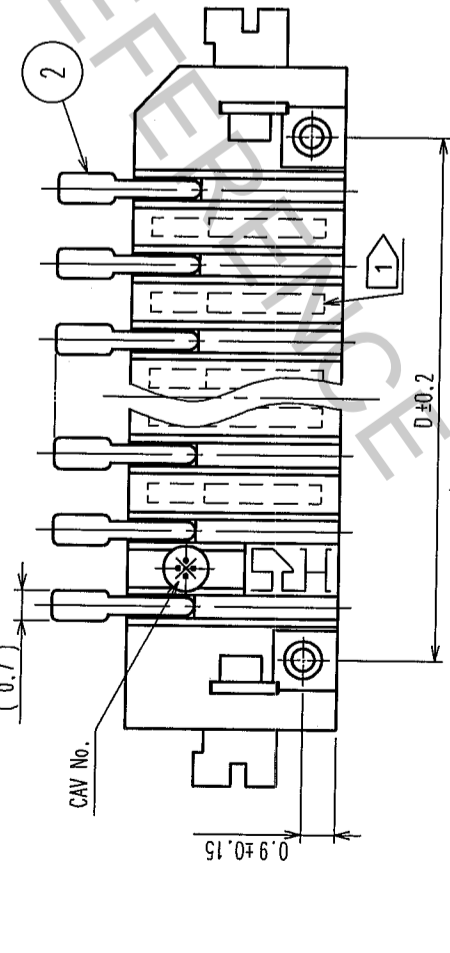
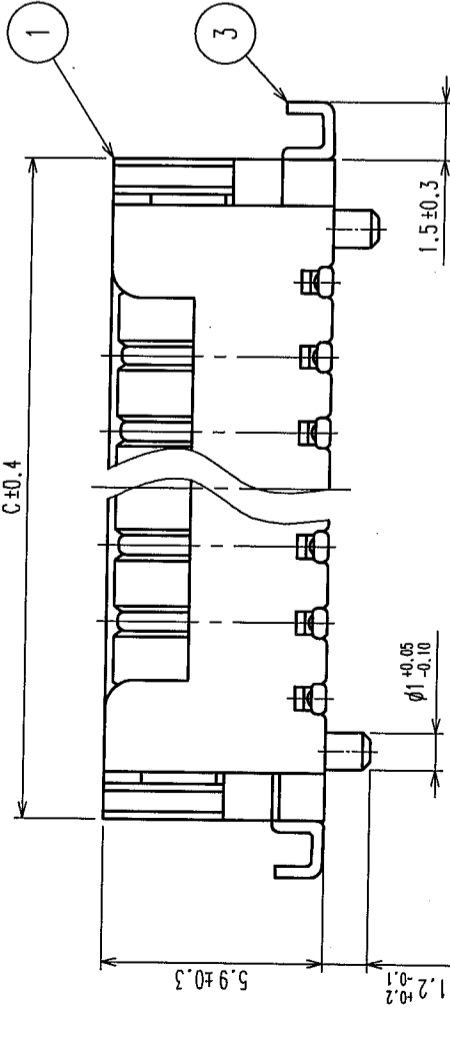
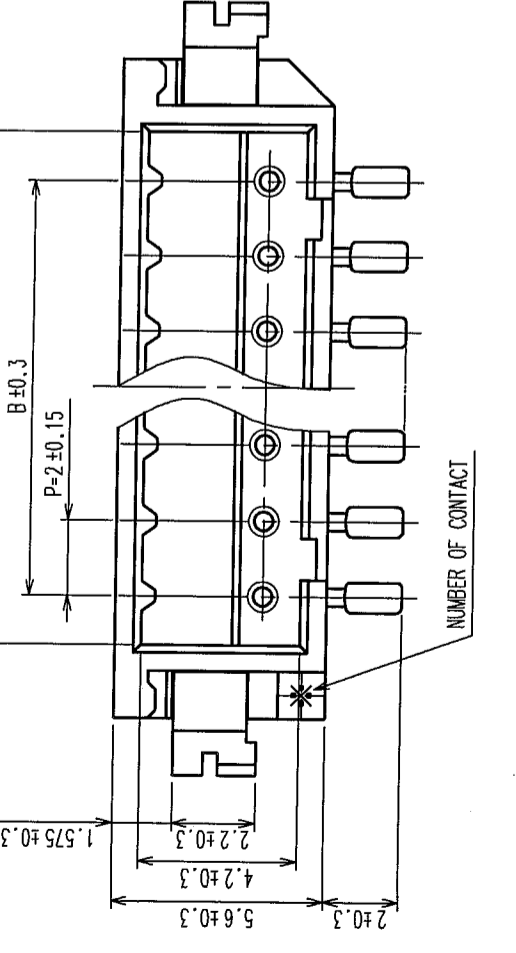
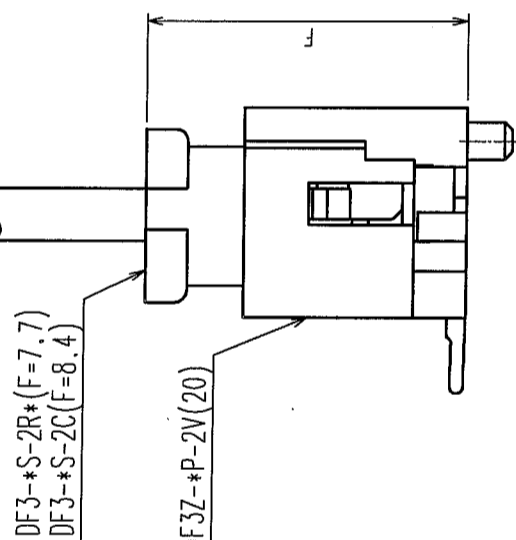
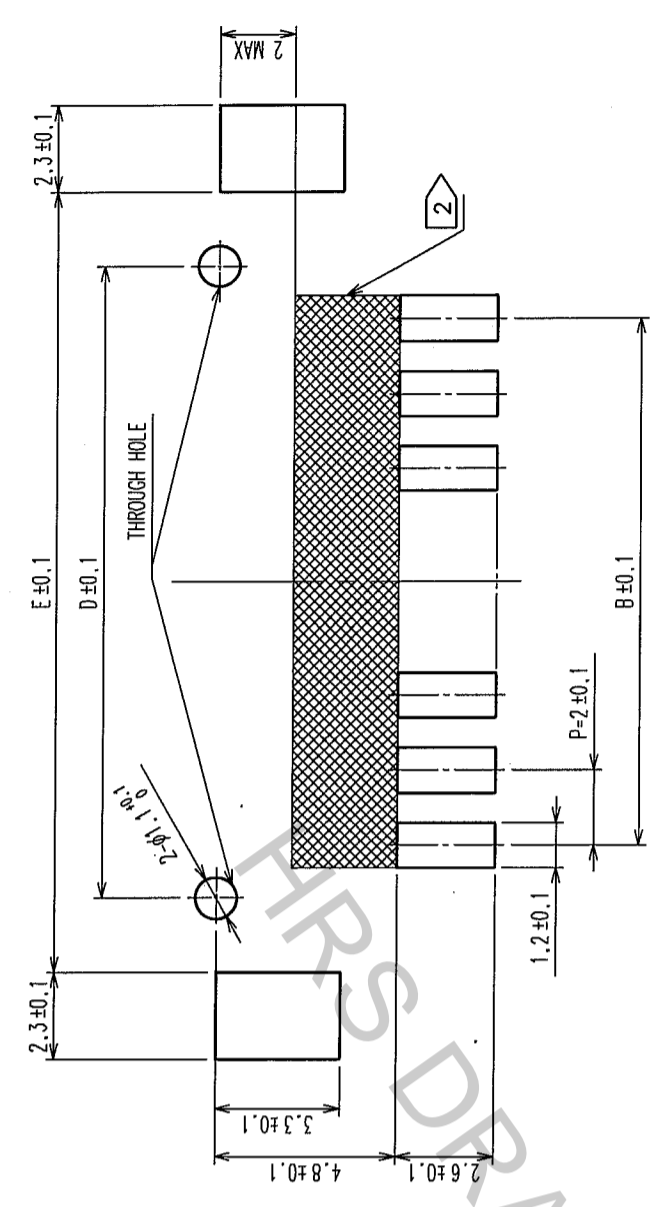

PART NO.	CODE NO.	A	B	C	D	E
DF3Z- 2P-2V(20)	CL543-1028-4-20	4.6	2.0	8.5	4.8	8.74
DF3Z- 3P-2V(20)	CL543-1029-7-20	6.6	4.0	10.5	6.8	10.74
DF3Z- 4P-2V(20)	CL543-1030-6-20	8.6	6.0	12.5	8.8	12.74
DF3Z- 5P-2V(20)	CL543-1031-9-20	10.6	8.0	14.5	10.8	14.74
DF3Z- 6P-2V(20)	CL543-1032-1-20	12.6	10.0	16.5	12.8	16.74
DF3Z- 7P-2V(20)	CL543-1033-4-20	14.6	12.0	18.5	14.8	18.74
DF3Z- 8P-2V(20)	CL543-1034-7-20	16.6	14.0	20.5	16.8	20.74
DF3Z- 9P-2V(20)	CL543-1035-0-20	18.6	16.0	22.5	18.8	22.74
DF3Z-10P-2V(20)	CL543-1036-2-20	20.6	18.0	24.5	20.8	24.74
DF3Z-11P-2V(20)	CL543-1037-5-20	22.6	20.0	26.5	22.8	26.74
DF3Z-12P-2V(20)	CL543-1038-5-20	24.6	22.0	28.5	24.8	28.74
DF3Z-13P-2V(20)	CL543-1039-0-20	26.6	24.0	30.5	26.8	30.74
DF3Z-14P-2V(20)	CL543-1040-0-20	28.6	26.0	32.5	28.8	32.74
DF3Z-15P-2V(20)	CL543-1041-2-20	30.6	28.0	34.5	30.8	34.74

NOTES

1. WHEN THE NUMBER OF CONTACT IS 2 TO 10, THIS PART IS FREE FROM SINKAGE INDICATING DOTTED LINES. WHEN THE NUMBER OF CONTACT IS 11 TO 15, THERE ARE SINKAGES INDICATING DOTTED LINES.

2. IF THERE IS PATTERN ON PART, THERE IS A POSSIBILITY THAT IS WILL MAKE CONTACT WITH THE LEADS. LEAD CO-PLANARITY INCLUDE REINFORCED METAL FITTINGS SHALL BE 0.1mm MAX.

3.

5	S.PVC	GRAY
---	-------	------

4	RIGID POLYVINYLCHLORIDE	ELECTROSTATIC PROTECTION, CLEAR
---	-------------------------	---------------------------------

3	BRASS	SURFACE:TIN PLATED 1μm min (UNDER PLATING)NICKEL PLATED 1μm min
---	-------	---

NO.	MATERIAL	FINISH, REMARKS	DESIGNED	CHECKED	APPROVED	REMARKS
-----	----------	-----------------	----------	---------	----------	---------

M.Nakamoto	H.Umehara	T.Miyazaki	T.Oma			
------------	-----------	------------	-------	--	--	--

'04.03.25	'04.03.25	'04.03.25	'04.03.25			
-----------	-----------	-----------	-----------	--	--	--

EDC3-305939-10	DF3Z-*P-2V(20)
----------------	----------------

5 : 1	CL543-
-------	--------

HIROSE ELECTRIC CO., LTD	FORM NO.229
--------------------------	-------------

TO

NO.	DESCRIPTION OF REVISIONS	BY	CHKD	DATE	COUNT	DESCRIPTION OF REVISIONS	BY	CHKD	DATE
1					1				
2					1				
3					1				
4					1				
5					1				

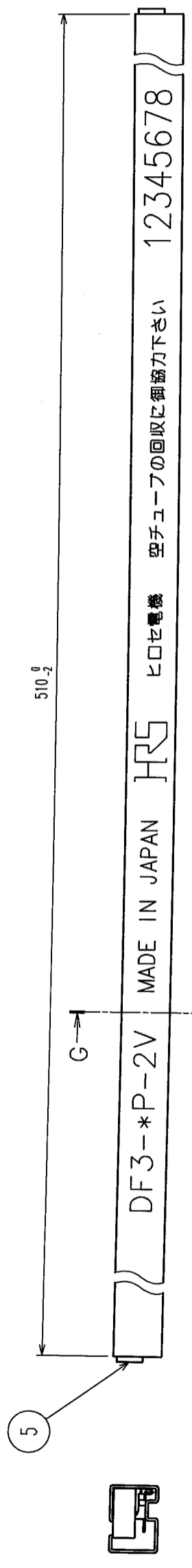

G-G(10:1)

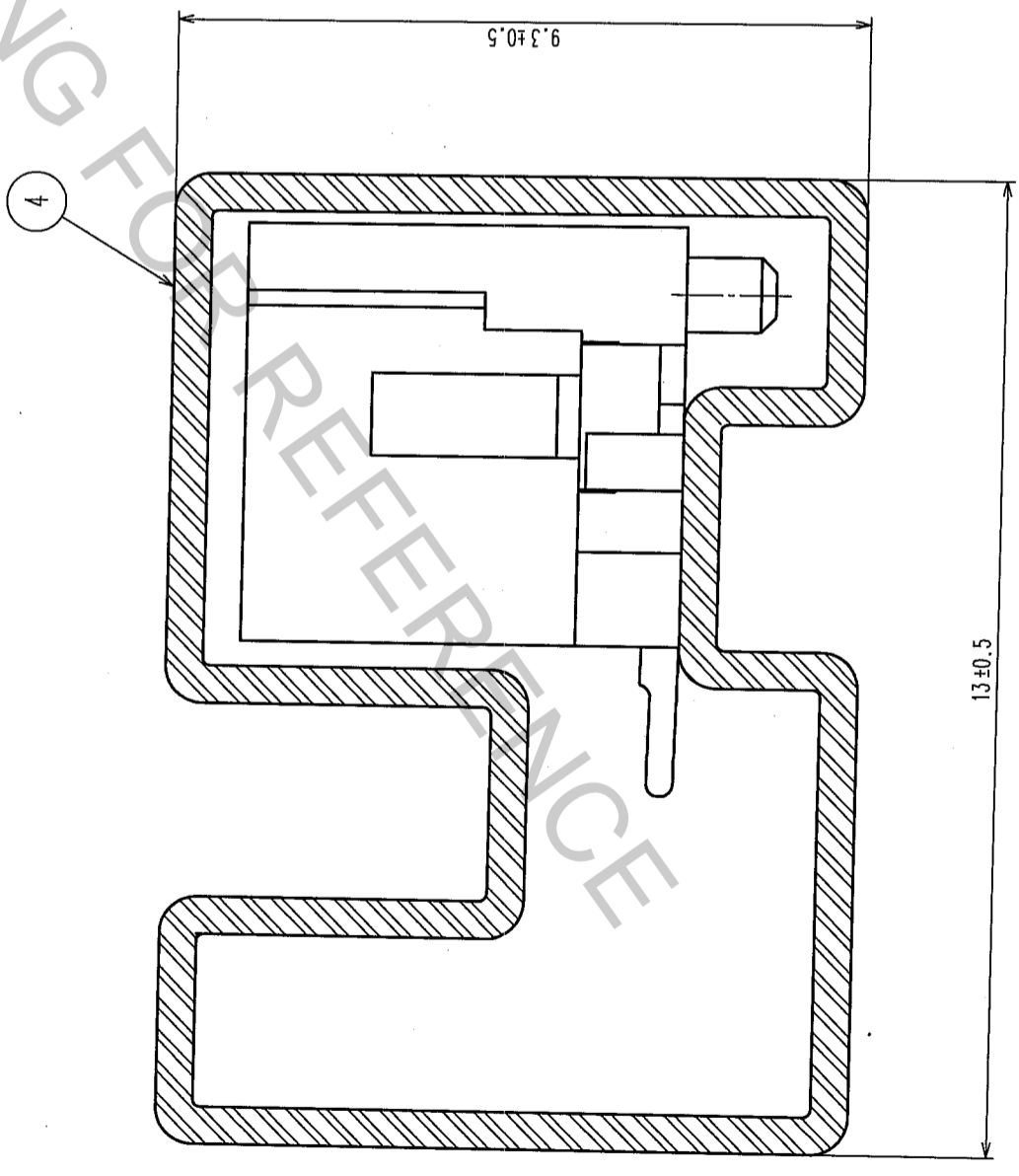

NOTES 4. NUMBER OF CONNECTORS PER A MAGAZINE CASE SHALL BE IN ACCORDANCE WITH THE LIST.
 5. THESE CONNECTORS SHALL BE ON SALED IN ACCORDANCE WITH THE MULTIPLE QUANTITY ON THE LIST.

CODE NO.	PART NO.	NUMBER OF CONNECTORS
CL543-1028-4-20	DF3Z- 2P-2V(20)	4 1
CL543-1029-7-20	DF3Z- 3P-2V(20)	3 4
CL543-1030-6-20	DF3Z- 4P-2V(20)	3 0
CL543-1031-9-20	DF3Z- 5P-2V(20)	2 6
CL543-1032-1-20	DF3Z- 6P-2V(20)	2 3
CL543-1033-4-20	DF3Z- 7P-2V(20)	2 1
CL543-1034-7-20	DF3Z- 8P-2V(20)	1 9
CL543-1035-0-20	DF3Z- 9P-2V(20)	1 8
CL543-1036-2-20	DF3Z-10P-2V(20)	1 7
CL543-1037-5-20	DF3Z-11P-2V(20)	1 5
CL543-1038-5-20	DF3Z-12P-2V(20)	1 4
CL543-1039-0-20	DF3Z-13P-2V(20)	1 4
CL543-1040-0-20	DF3Z-14P-2V(20)	1 3
CL543-1041-2-20	DF3Z-15P-2V(20)	1 2

NO.	MATERIAL	FINISH, REMARKS	NO.	MATERIAL	FINISH, REMARKS
CL					
DRAWN		M. Nakamoto	DESIGNED		H. Umehara
DATE		'04.03.25	DATE		'04.03.25
CHECKED		T. Miyazaki	APPROVED		T. Oma
DATE		'04.03.25	DATE		'04.03.25
RELEASED			DATE		
DRAWING NO.		EDC3-305939-10	PART NO.		DF3Z-*P-2V(20)
SCALE		FR:EE	CODE NO.		CL543-
UNITS		mm	DRAWING NO.		EDC3-305939-10
HRS		HIROSE ELECTRIC CO., LTD	CODE NO.		CL543-
FR:EE			PART NO.		DF3Z-*P-2V(20)
UNITS		mm	CODE NO.		CL543-