

1 2 3 4 5 6

A

B

C

D

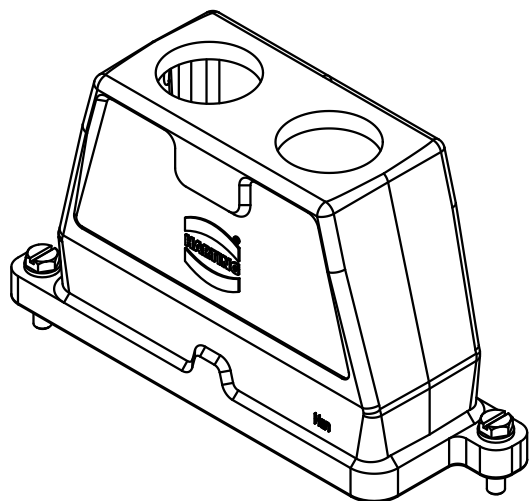
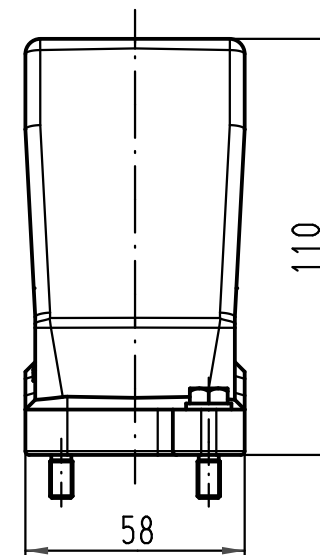
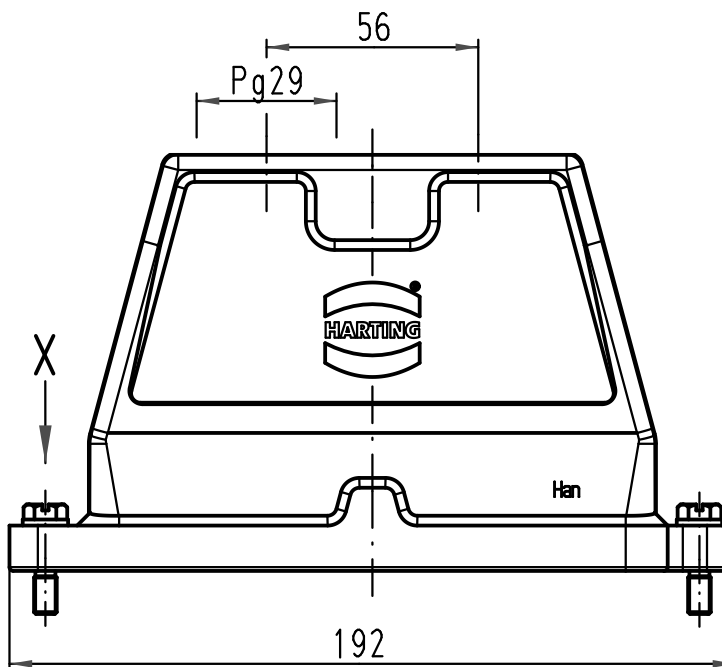
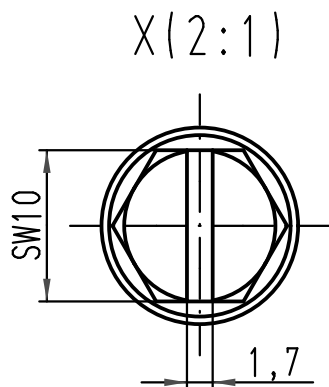

All Dimensions in mm Original Size DIN A 4		Techn. Character.		Nicht tolerierte Maße/ Free size tolerances	
			Dat.	Name	Maßstab/ Scale 1:2
		Detail.	10.01.11	Ho	
		Insp.		Be	
		Stand.			
A		HARTING Electric GmbH & Co. KG D-32339 Espelkamp			
Mod.	Dat.	Name	TB 09 40 024 0433		Blatt/ page
			Sub. TB 09 40 024 0433 v. 05.03.99		