

HRXL-MaxSonar® - WR/WRC™ Series



High Resolution, IP67 Weather Resistant, Ultra Sonic Range Finder

MB7360, MB7363, MB7366, MB7367, MB7369, MB7380, MB7383, MB7386, MB7387, MB7389

The HRXL-MaxSonar-WR/WRC sensor line is the most cost-effective solution for applications where precision range-finding, low-voltage operation, space saving, low-cost, and IP67 weather resistance rating is needed. This sensor component module allows users of other more costly precision rangefinders to lower the cost of their systems without sacrificing performance. Additionally, this sensor line allows cost-sensitive designers to choose this precision sensor as a performance upgrade over other lower performance sensors.

The HRXL-MaxSonar-WR/WRC sensor line provides high accuracy and high resolution ultrasonic proximity detection and ranging in air, with an IP67 weather resistant rating. This sensor line features 1-mm resolution, target-size and operating-voltage compensation for improved accuracy, superior rejection of outside noise sources, internal speed-of-sound temperature compensation and optional external speed-of-sound temperature compensation. The HRXL-MaxSonar-WR/WRC models are available in 5-meter or 10-meter models. This ultrasonic sensor detects objects from 1-mm and ranges to objects from 30-cm* to maximum range. Objects closer than 30-cm* are typically reported as 30-cm*. The interface output formats are pulse width, analog voltage, and serial digital in either RS232 (MB7360 series) or TTL (MB7380 series). Factory calibration is standard. *For 10 meter sensors this distance is 50-cm

Precision Ultrasonic Range Sensing

- Range-finding at a fraction of the cost of other precision rangefinders
- Reading-to-reading stability of 1-mm at 1-meter is typical¹
- Accuracy is factory-matched providing a typical accuracy of 1% or better^{1,2}
- Compensation provided for target size variation and operating voltage range
- Internal temperature compensation is standard
- Optional external temperature compensation
- Determines range to largest object (MB7369, MB7389)
- Determines range to first detectable object (MB7360, MB7363, MB7366, MB7367, MB7380, MB7383, MB7386, MB7387)
- Excellent clutter rejection

Very Low Power Requirements

- Wide, low supply voltage requirements eases battery powered design
- Low current draw reduces current drain for battery operation
- Fast first reading after power-up eases battery requirements
- Very low-power rangefinder, excellent for multiple sensor or battery based systems

Easy to use Component Module

- Stable and reliable range readings and excellent noise rejection make the sensor easy to use for most users
- Easy to use interface with distance provided in a variety of outputs
- Target size compensation provides greater consistency and accuracy when switching targets
- Sensor automatically handles acoustic noise^{2,4}
- Small and easy to mount
- Calibrated sensor eliminates most sensor to sensor variations

Range Outputs

- Pulse width, 1uS/mm resolution
- Analog Voltage, 5-mm resolution (5-meter sensors)
- Analog Voltage, 10-mm resolution (10-meter sensors)
- Serial, 1-mm resolution
- Available in RS232 (MB7360 series) or TTL (MB7380 series)

General Characteristics

- Low cost ultrasonic rangefinder
- Sensor dead zone virtually gone¹
- Object proximity detection from front sensor face to 5-meters or 10-meters
- Resolution of 1-mm
- Distance sensor from 30-cm to 5-meters or 50-cm to 10-meters based on model
- Excellent² Mean Time Between Failure (MTBF)

- Triggered operation yields real-time range data
- Free run operation with superior noise rejection³
- Operating temperature range from -40°C to +65°C
- Operating voltage from 2.7V to 5.5V
- Nominal current draw of 2.3mA at 3.3V, and 3.1mA at 5V
- IP67 Rated

Applications & Uses

- Snow sensor⁵
- Weather station monitoring
- Tank level measurement⁶
- Bin level measurement
- Corn and grain level measurement⁵
- Proximity zone detection
- People detection
- Robot ranging sensor
- Autonomous navigation distance measuring
- Long range object detection
- Environments with acoustic and electrical noise
- Height monitors
- Auto sizing
- Box dimensions
- Automated factory systems
- This product is not recommended as a device for personal safety

Notes:

- ¹ Refer to section that compares WR to WRC on page 4
- ² Users are encouraged to evaluate the sensor performance in their application
- ³ Reference pages 8-9 for part specific timing information by design
- ⁴ by design
- ⁵ MB7363 or MB7383 is the recommended sensor
- ⁶ MB7369 or MB7389 is the recommended sensor

HRXL-MaxSonar-WR Circuit

The sensor functions using a variety active components which create an excellent ultrasonic sensor solution. The schematic is shown to provide the user with detailed connection information.

HRXL-MaxSonar-WR Pin Out

Pin 1- Temperature Sensor Connection: Leave this pin unconnected if an external temperature sensor is not used. For best accuracy, this pin is optionally connected to the HR-MaxTemp temperature sensor. Some additional information for the temperature sensor can be found on page 4 of the datasheet.

Pin 2- Pulse Width Output: This pin outputs a pulse width representation of the distance with a scale factor of 1uS per mm. Pulse width output is sent with a value within 0.5% of the serial output.

Pin 3- Analog Voltage Output: After the ~50ms power up initialization, the voltage on this pin is set to a low voltage. Once the sensor has completed a range reading the voltage on this pin is set to the voltage corresponding to the latest measured distance. This pin outputs an analog voltage scaled representation of the distance.

The 5-meter sensors (MB7360, MB7367, MB7369, MB7380, MB7387, and MB7389) use a scale factor of (Vcc/5120) per 1-mm. The distance is output with a 5-mm resolution. This output voltage is referenced to GND. The analog voltage output is typically within ±5-mm of the serial output.

The 10-meter sensors (MB7363, MB7366, MB7383, and MB7386) use a scale factor of (Vcc/10240) per 1-mm. The distance is output with a 10-mm resolution. This output voltage is referenced to GND. The analog voltage output is typically within ±10-mm of the serial output.

Using a 10-bit analog to digital converter with the 5-meter sensors, one can read the analog voltage counts (i.e. 0 to 1023) directly and just multiply the number of counts in the value by 5 to yield the range in mm. For example, 60 counts corresponds to 300-mm (where $60 * 5 = 300$), and 1000 counts corresponds to 5,000-mm (where $1000 * 5 = 5,000$ -mm).

Using a 10-bit analog to digital converter with the 10-meter sensors, one can read the analog voltage counts (i.e. 0 to 1023) directly and just multiply the number of counts in the value by 10 to yield the range in mm. For example, 30 counts corresponds to 300-mm (where $30 * 10 = 300$), and 1000 counts corresponds to 10,000-mm (where $1000 * 10 = 10,000$ -mm).

Pin 4- Ranging Start/Stop: This pin is internally pulled high. If this pin is left unconnected or held high, the sensor will continually measure and output the range data. If held low, the HRXL-MaxSonar-WR will stop ranging. Bring high for 20uS or longer to command a range reading.

Filtered Range Data: When pin 4 is left high on the sensors, the sensors will continue to range. The data that is output includes a filter for increased accuracy. The sensors will output the range based on recent range information. The filter does not affect the speed at which data is made available to the user but instead allows for more consistent range information to be presented. For sensor specific timing and filter information refer to pages 8 and 9.

Real-time Range Data: When pin 4 is low and then brought high, the sensor will operate in real time and the first reading output will be the range measured from this first commanded range reading. When the sensor tracks that the RX pin is low after each range reading, and then the RX pin is brought high, unfiltered real time range information can be obtained. For timing information please refer to pages 8 and 9.

Pin 5-Serial Output: The MB736X sensors have an RS232 data format (with 0 to Vcc levels) and the MB738X sensors have a TTL outputs. The output is an ASCII capital "R", followed by four ASCII character digits representing the range in millimeters, followed by a carriage return (ASCII 13). The maximum range reported is 4999 (5-meter models) or 9998 (10-meter models). A range value of 5000 or 9999 corresponds to no target being detected in the field of view.

The serial data format is 9600 baud, 8 data bits, no parity, with one stop bit (9600-8-N-1). Because the data is presented in a binary data format, the serial output is most accurate .

V+ Pin 6 - Positive Power, Vcc: The sensor operates on voltages from 2.7V - 5.5V DC. For best operation, the sensor requires that the DC power be free from electrical noise. (For installations with known dirty electrical power, a 100uF capacitor placed at the sensor pins between V+ and GND will typically correct the electrical noise.)

GND Pin 7 – Sensor ground pin: DC return, and circuit common ground.

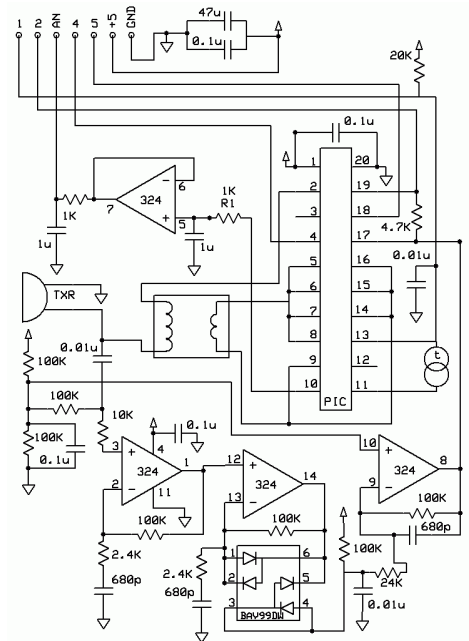

About Ultrasonic Sensors

Our ultrasonic sensors are in air, non-contact object detection and ranging sensors that detect objects within an area. These sensors are not affected by the color or other visual characteristics of the detected object. Ultrasonic sensors use high frequency sound to detect and localize objects in a variety of environments. Ultrasonic sensors measure the time of flight for sound that has been transmitted to and reflected back from nearby objects. Based upon the time of flight, the sensor outputs a range reading.

Device Comparison

Part Number Features Chart

Part Number	Serial Interface	First Detectable target	Most Likely Filter	High Performance HR Filter ¹	Compact WRC	Soft/Small Target Detection ²	5 Meter Max Range	10 Meter Max Range
MB7360	RS232	Yes		Yes			Yes	
MB7363	RS232	Yes		Yes		Yes		Yes
MB7366	RS232	Yes		Yes				Yes
MB7367	RS232	Yes		Yes	Yes		Yes	
MB7369	RS232		Yes	Yes			Yes	
MB7380	TTL	Yes		Yes			Yes	
MB7383	TTL	Yes		Yes		Yes		Yes
MB7386	TTL	Yes		Yes				Yes
MB7387	TTL	Yes		Yes	Yes		Yes	
MB7389	TTL		Yes	Yes			Yes	

Notes

¹ exceeds the performance of the first generation XL-MaxSonar-WR models MB70##. Also includes target size compensation, internal temperature sensor, external temperature sensor, factory calibration, supply voltage droop compensation, continuous automatic calibration, and side lobe suppression.

² Higher gain and other calibration allows better performance to soft targets such as snow covering.

Auto Calibration

Each time the HRXL-MaxSonar-WR takes a range reading, it calibrates itself. The sensor then uses this data to range objects. If the temperature, humidity, or applied voltage changes during sensor operation, the sensor will continue to function normally over the rated temperature range while applying compensation for changes caused by temperature and voltage.

Target Size Compensation

Most low cost ultrasonic rangefinders will report the range to smaller size targets as farther than the actual distance. In addition, they may also report the range to larger size targets as closer than the actual distance.

The HRXL-MaxSonar-WR sensor line compensates for target size differences. This means that, provided an object is large enough to be detected, the sensor will report the same distance, typically within 1%¹, regardless of target size¹. Smaller targets can have additional detection noise that may limit this feature. In addition, targets with small or rounded surfaces may have an apparent distance that is slightly farther, where the distance reported may be a composite of the sensed object(s). Compensation for target size is applied to all range outputs: pulse width, analog voltage, and serial format output by the sensor.

Supply Voltage Droop and Charge Compensation

During power up, the HRXL-MaxSonar-WR sensor line will calibrate itself for changes in supply voltage. Additionally, the sensor will compensate if the supplied voltage gradually changes.

If the average voltage applied to the sensor changes faster than 0.5V per second, it is best to remove and reapply power to the sensor.

For best operation, the sensor requires noise free power. If the sensor is used with noise on the supplied power or ground, the readings may be affected. Typically adding a 100uF capacitor at the sensor between the V+ and GND pins will correct most power related electrical noise issues.

Notes:

¹ Refer to section that compares WR to WRC on page 4

HRXL-MaxSonar®-WR™ Temperature Compensation

On Board – Internal Temperature Compensation

The speed of sound in air increases about 0.6 meters per second, per degree centigrade. Because of this, each HRXL-MaxSonar-WR is equipped with an internal temperature sensor which allows the sensor to apply compensation for speed of sound changes.

The actual air temperature of the path between the sensor and the target may not match the temperature measured at the sensor electronics. Sensors can be mounted in vertical applications, or applications where the environmental temperature gradient is severe. These users may experience a temperature measurement error which will affect the sensor accuracy. For example, buildings with a height of 3-meters can have floor to ceiling temperature variations of 5°C or more.

Because of these temperature effects, users desiring the highest accuracy output are encouraged to use a properly mounted external temperature sensor or to manually account for this measurement error.

HR-MaxTemp, an External Temperature Sensor

Although the HRXL-MaxSonar-WR has an internal temperature sensor; for best accuracy, users are encouraged to use the optional external temperature sensor. On power-up, the HRXL-MaxSonar-WR will automatically detect an attached HR-MaxTemp temperature sensor and begin to apply temperature compensation using the external temperature sensor.

The external temperature sensor allows for the most accurate temperature compensation, by allowing temperature readings to be taken that better reflect the composite temperature of the acoustic ranging path. For best results users are encouraged to connect the temperature sensor midway between the HRXL-MaxSonar-WR and the expected target distance.

Most Likely Filter (MB7369 and MB7389)

In general, the HRXL-MaxSonar-WRM will select the largest target from its field of view and report its range. Even so, objects up close may provide significantly greater returns than distant objects. Users are encouraged to test the sensor in their application to verify usability.

The HRXL-MaxSonar-WRM sensors are equipped with filtering firmware which allows the sensor to ignore smaller targets and noise, and still report the target that gives the largest acoustic return. (The sensor will also reject periodic noise, even noise that has a higher amplitude than the acoustic return from the target.) This gives users the flexibility to consistently range larger targets in the presence of clutter and noise. If the largest target is removed from the field of view, the HRXL-MaxSonar-WRM will switch to the target that gives the next largest detectable return.

The MB7369 (RS232) and MB7389 (TTL) were designed for applications where users were concerned with ranging the distance to large flat targets (such as in a water tank). This stands in contrast to other HRXL-MaxSonar-WR sensors which will report the distance to the first detectable target.

The Most-Likely filter is designed to report the distance to the largest acoustic return while ignoring smaller targets. When targets are of similar amplitude reflections, preference is given to the closest target.

HRXL-MaxSonar-WRC (MB7367, MB7387)

The 5-meter HRXL-MaxSonar-WR and HRXL-MaxSonar-WRM sensors are the most accurate sensor in the HRXL-MaxSonar-WR sensor line.

The HRXL-MaxSonar-WRC is less accurate than the 5-meter HRXL-MaxSonar-WR sensors by about 1.0%. The HRXL-MaxSonar-WRC also has a dead zone between 0-4cm. The HRXL-MaxSonar-WRC sensor is also the least sensitive sensor in the HRXL-MaxSonar-WR sensor line.

The HRXL-MaxSonar-WRC sensors' accuracy is about 1.0% less accurate than the 5-meter HRXL-MaxSonar-WR sensors

HRXL-MaxSonar-WRLS (MB7363 and MB7383)

The HRXL-MaxSonar-WRLS sensors are 10 meter sensors with a higher sensitivity than other HRXL-MaxSonar-WR products. This sensor is recommended for applications in which objects do not reflect enough ultrasonic sound for other sensors to report the range to, such as snow, people, and grain. Users are encouraged to test the sensor in their application to verify usability.

Range “0” location

The HRXL-MaxSonar-WR reports the range to distant targets starting from where the threading and nut meet on the sensor housing as shown in the diagram below.

In general, the HRXL-MaxSonar-WR will report the range to the leading edge of the closest detectable object. Target detection has been characterized in the sensor beam patterns.

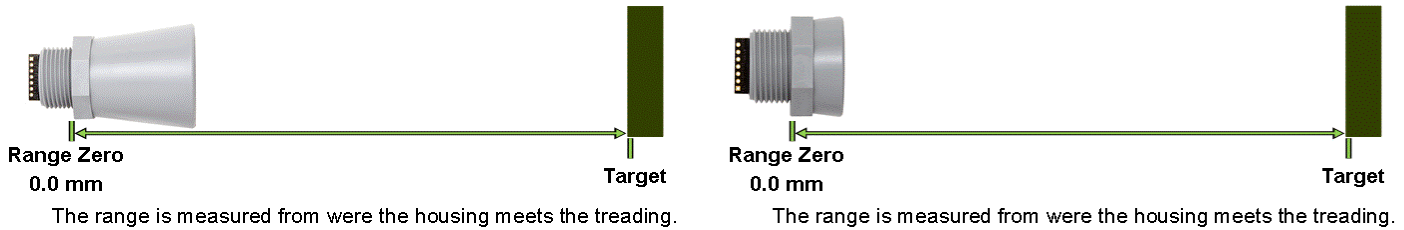

Sensor minimum distance - No Sensor Dead Zone (5 meter parts)

(MB7360, MB7367, MB7369, MB7380, MB7387, and MB7389)

The 5 meter sensors have a minimum reported distance of 30-cm (11.8 inches). However, the HRXL-MaxSonar-WR will report targets up to the sensor face (for the WR sensors)¹ and to within 1-mm of the front sensor face (for the WRC sensors)¹. For the 5 meter HRXL-MaxSonar-WR sensors, targets closer than 300-mm will typically range as 300-mm.

Notes: ¹ refers to section that compares WR to WRC on page 11

Sensor minimum distance - No Sensor Dead Zone (10 meter parts)

(MB7363, MB7366, MB7383, and MB7386)

The 10 meter sensors have a minimum reported distance of 50-cm (19.7 inches). However, the HRXL-MaxSonar-WRL will report targets up to the sensor face. For the 10 meter HRXL-MaxSonar-WRL sensors, targets closer than 500-mm will typically range as 500-mm.

Sensor Operation from 30-cm to 50-cm

Because of acoustic phase effects in the near field, objects between 30-cm and 50-cm may experience acoustic phase cancellation of the returning waveform resulting in inaccuracies of up to 5-mm. These effects become less prevalent as the target distance increases, and have not been observed past 50-cm. For this reason, users that require the highest sensor accuracy are encouraged to mount the HRXL-MaxSonar-WR farther than 50-cm away from objects.

HRXL-MaxSonar®-WR™ Mechanical Dimensions

Values Are Nominal

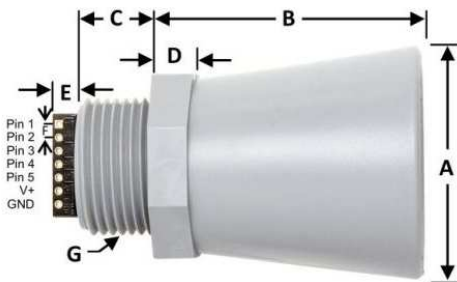

A	1.72" dia.	43.8 mm dia.
B	2.00"	50.7 mm
C	0.58"	14.4 mm
D	0.31"	7.9 mm
E	0.23"	5.8 mm
F	0.1"	2.54 mm
G	3/4"-14 National Pipe Thread Straight	
H	1.032" dia.	26.2 mm dia.
I	1.37"	34.8 mm
Weight, 1.76 oz., 50 grams		

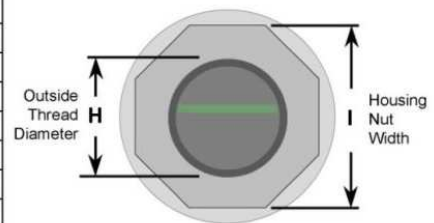

HRXL-MaxSonar®-WRC™ Mechanical Dimensions

Values Are Nominal

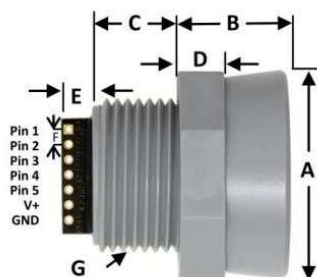

A	1.37" dia.	34.7 mm dia.
B	0.70"	17.9 mm
C	0.57"	14.4 mm
D	0.31"	7.9 mm
E	0.23"	5.8 mm
F	0.1"	2.54 mm
G	3/4"-14 National Pipe Thread Straight	
H	1.032" dia.	26.2 mm dia.
I	1.37"	34.8 mm
Weight, 1.23 oz., 32 grams		

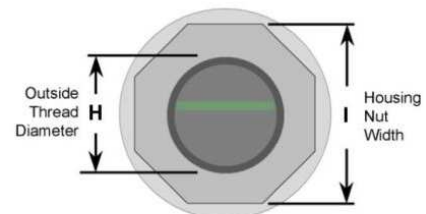

HRXL-MaxSonar-WR Sensor Operating Modes

Free-Run Operation

When operating in free run mode, the HRXL-MaxSonar-WR sensors are designed to be used in a variety of outdoor, industrial, or indoor environments. Many acoustic noise sources will have little to no effect on the reported range of the HRXL-MaxSonar-WR sensors. Most range readings are accurately reported. If the range readings are affected, the effect is typically less than 5-mm¹. This allows users to employ real-time ultrasonic distance sensing without the need for additional supporting circuitry or complicated user software.

Multiple HRXL-MaxSonar-WR sensors can be operated in the same environment. The internal noise filter is able to filter out the ultrasonic noise from other HRXL-MaxSonar-WR sensors with minimal interference. Typically when operating with multiple sensors, the range readings will be within +/- 1 cm of the actual range to the intended target.

Independent Sensor Operation

The HRXL-MaxSonar-WR sensors have the capability to operate independently when the user desires. When using the HRXL-MaxSonar-WR sensors in single or independent sensor operation, it is easiest to allow the sensor to free-run. Free-run is the default mode of operation for all of the MaxBotix Inc., sensors. The HRXL-MaxSonar-WR sensors have three separate outputs that update the range data simultaneously: Analog Voltage, Pulse Width, and Serial data. Below are diagrams on how to connect the sensor for each of the three outputs when operating in a single or independent sensor operating environment.

Analog Output Sensor Operation

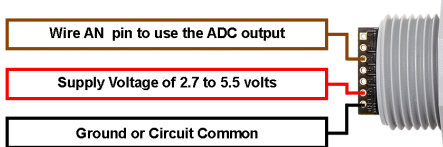

Pulse Width Output Sensor Operation

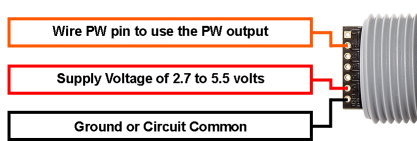

Serial Output Sensor Operation

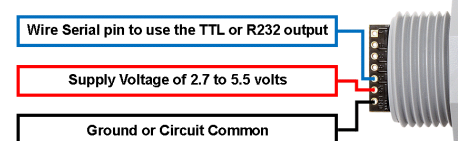

Notes:

¹ Refer to section that compares WR to WRC on page 4

Using Multiple Sensors in a Single System

Multiple HRXL-MaxSonar-WR sensors can be used simultaneously in the same environment with little to no interference (cross-talk). Even so, some cross-talk may still occur for users wishing to use a large number of sensors in the same environment. This interference is rare and can be up to +/- 1 cm of the target's distance. Because of this, sensor to sensor interference must be accounted for. To avoid interference between sensors, chaining can be used to prevent cross-talk between sensors. This will be necessary when using 3+ sensors depending on mounting and environment.

The recommended chaining method is AN Output Commanded Loop. The first sensor will range, then trigger the next sensor to range and so on for all the sensors in the array. Once the last sensor has ranged, the array stops until the first sensor is triggered to range again. Below is a diagram on how to set this up.

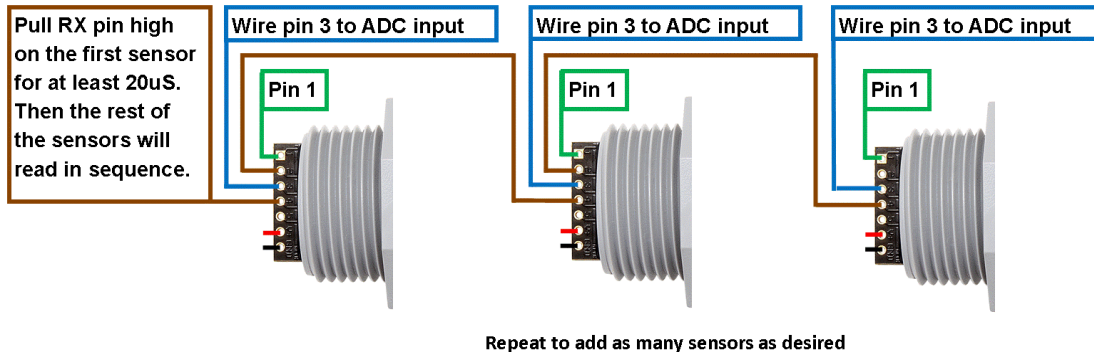

Another recommended chaining method is AN Output Constantly Looping. The first sensor will range, then trigger the next sensor to range and so on for all the sensors in the array. Once the last sensor has ranged, it will trigger the first sensor in the array to range again and will continue this loop indefinitely. Below is a diagram on how to set this up.

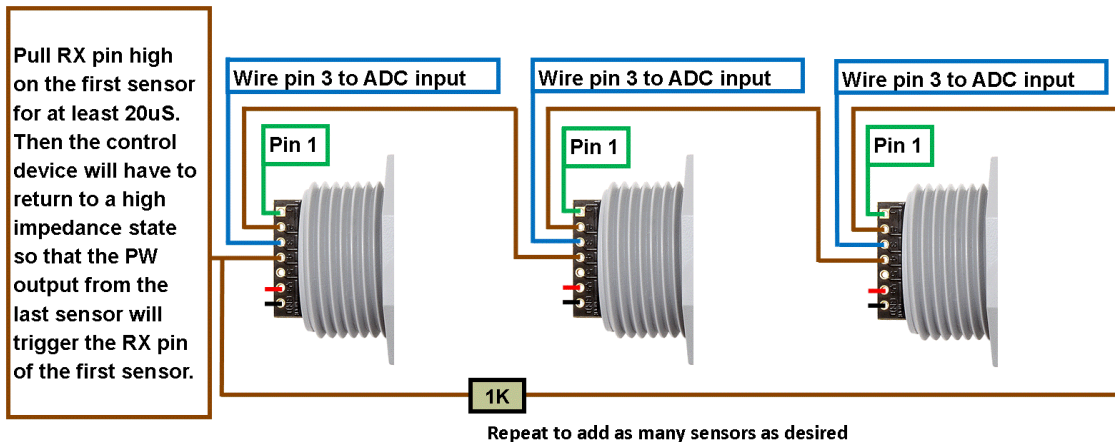

Sensor Timing Diagrams

Power Up Timing

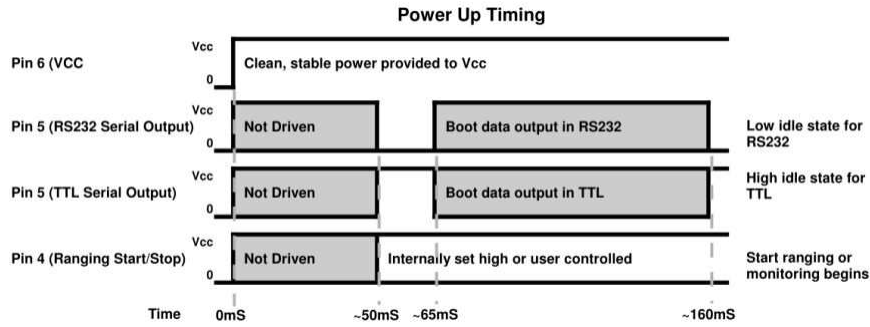

Sensor Free-Run Timing

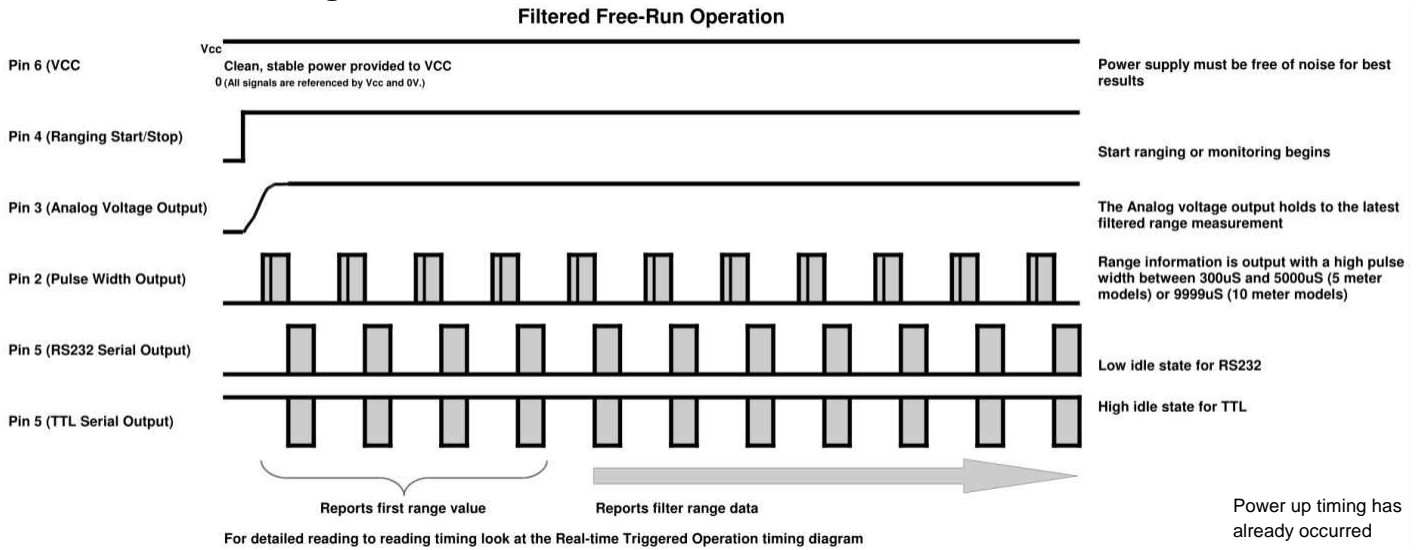

Product	Maximum Refresh Rate	Free Run Filter	Pulse Width Reported	Serial Data Reported	Pin 4 Brought Low	End of Range Cycle
MB7360, MB7367, MB7380, MB7387	7.5 Hz	1.5Hz	~118mS	~123mS	~132mS	~133mS
MB7369, MB7389	6.67Hz	1.33Hz	~135mS	~140mS	~147mS	~148mS
MB7363, MB7366, MB7383, MB7386	6Hz	1.2Hz	~148mS	~158mS	~165mS	~166mS

When operating in free run mode, the HRXL-MaxSonar-WR sensors are designed to be used in a variety of outdoor, industrial, or indoor environments. Many acoustic noise sources will have little to no effect on the reported range of the HRXL-MaxSonar-WR sensors¹. Most range readings are accurately reported¹. If the range readings are affected, the effect is typically less than 5-mm¹. This allows users to employ real-time ultrasonic distance sensing without the need for additional supporting circuitry or complicated user software.

The HRXL-MaxSonar-WR use an internal bandwidth filter to process range data. This filter improves the sensor's performance for accuracy, noise rejection, and reading to reading stability. The filtering in the free-run operation also permits additional acoustic and electrical noise tolerance.

On the HRXL-MaxSonar-WR sensors when pin 4 is left high, the sensor will continue to range, the data output includes a filter for increased accuracy in environments with acoustic noise. The HRXL-MaxSonar-WR sensors will output the range based on recent range information. The filter does not affect the speed at which data is made available to the user but instead allows for more consistent range information to be presented.

Notes:
¹ Refer to section that compares WR to WRC on page 4

Sensor Timing Diagrams Cont.

Triggered—Real-time Operation Timing

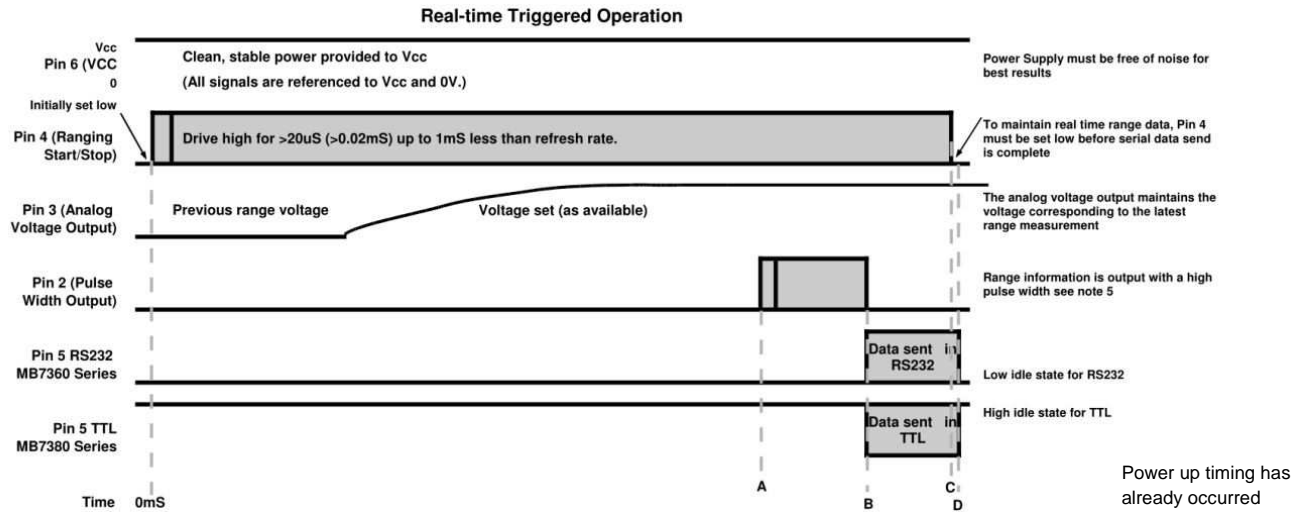

Product	Maximum Refresh Rate	A	B	C	D
MB7360, MB7367, MB7380, MB7387	7.5 Hz	~118mS	~123mS	~132mS	~133mS
MB7369, MB7389	6.67Hz	~135mS	~140mS	~147mS	~148mS
MB7363, MB7366, MB7383, MB7386	6Hz	~148mS	~158mS	~165mS	~166mS

Real-time or triggered operation allows users to take advantage of a few functions unavailable during free run mode. When operating in triggered mode, an unfiltered maximum refresh rate can be achieved. This triggered operation allows users to range targets moving away from or closer to the sensor faster than 240mm/s.

Users can enter and remain in the Real-time or Triggered Operation by making sure that before the end each range cycle, the voltage level on Pin 4 is set low. After the sensor has completed the last reading, then the voltage on Pin 4 is brought high. When Pin 4 is brought high, a brand new range cycle starts and the HRXL-MaxSonar-WR will output the most recent range data without filtering.

Readings during triggered operation are less accurate than the filtered operation by approximately +/- 5-mm. Because the range readings are not filtered, noise tolerance can be greatly reduced. Care should be taken to make sure that only one sensor is sampling range at a time.

When operating the HRXL-MaxSonar-WR in Triggered Operation, Pin 4 is must be brought high for a time frame greater than 20uS (0.02mS) and less than the time in Column C in the chart above. If Pin 4 remains high for a period of time greater than the value in Column C, the sensor will switch into free-run filter operation.

Column A shows the approximate time that the sensor starts to output the pulse width data. The Pulse Width output time can be as short as 300uS (minimum reported distance). For 5 meter sensors, the pulse width can take as long as 5000uS (maximum reported distance) to be sent. For 10 meter sensors the Pulse Width can take as long as 9999uS (maximum reported distance) to be sent.

Column B shows the approximate time during each range cycle when the serial data is output for the sensor. Range data takes ~8mS to be reported from the serial data output.

Column D shows the approximate time each range cycle takes to complete for each sensor.

HRXL-MaxSonar®-WR™ Beam Patterns

Background Information Regarding our Beam Patterns

Each HRXL-MaxSonar-WR sensor has a calibrated beam pattern. Each sensor is matched to provide the approximate detection pattern shown in this datasheet. This allows end users to select the part number that matches their given sensing application. Each part number has a consistent field of detection so additional units of the same part number will have similar beam patterns. The beam plots are provided to help identify an estimated detection zone for an application based on the acoustic properties of a target versus the plotted beam patterns.

Each beam pattern is a 2D representation of the detection area of the sensor. The beam pattern is actually shaped like a 3D cone (having the same detection pattern both vertically and horizontally). Detection patterns for dowels are used to show the beam pattern of each sensor. Dowels are long cylindered targets of a given diameter. The dowels provide consistent target detection characteristics for a given size target which allows easy comparison of one MaxSonar sensor to another MaxSonar sensor.

For each part number, the four patterns (A, B, C, and D) represent the detection zone for a given target size. Each beam pattern shown is determined by the sensor's part number and target size.

The actual beam angle changes over the full range. Use the beam pattern for a specific target at any given distance to calculate the beam angle for that target at the specific distance. Generally, smaller targets are detected over a narrower beam angle and a shorter distance. Larger targets are detected over a wider beam angle and a longer distance.

People Sensing:

For users that desire to detect people, the detection area to the 1-inch diameter dowel, in general, represents the area that the sensor will reliably detect people.

MB7360-MB7380 HRXL-MaxSonar® -WR™ Beam Pattern and Uses

The HRXL-MaxSonar-WR product line has a narrow sensor beam and provides reliable long range detection zones.

MB7360-MB7380

HRXL-MaxSonar® -WR/WRT™ Beam Pattern

Sample results for measured beam pattern are shown on a 30-cm grid. The detection pattern is shown for dowels of varying diameters that are placed in front of the sensor.

A 6.1-mm (0.25-inch) diameter dowel

B 2.54-cm (1-inch) diameter dowel

C 8.89-cm (3.5-inch) diameter dowel

D 11-inch wide board moved left to right with the board parallel to the front sensor face.

This shows the sensor's range capability.

Note: For people detection the pattern typically falls between charts A and B.

■ ■ Partial Detection

— 5.0 V

● 3.3 V

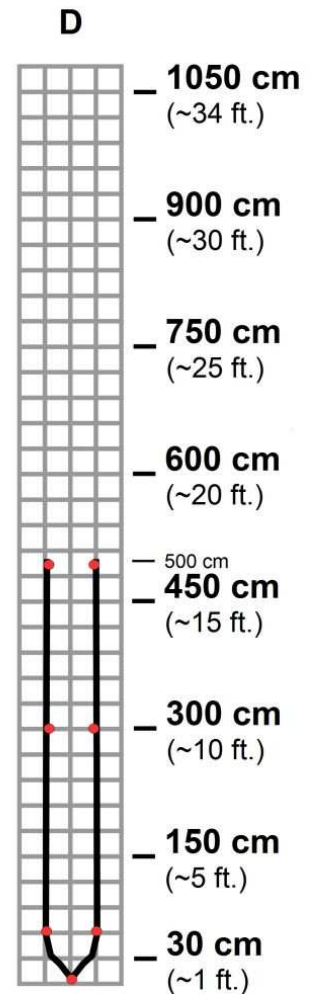
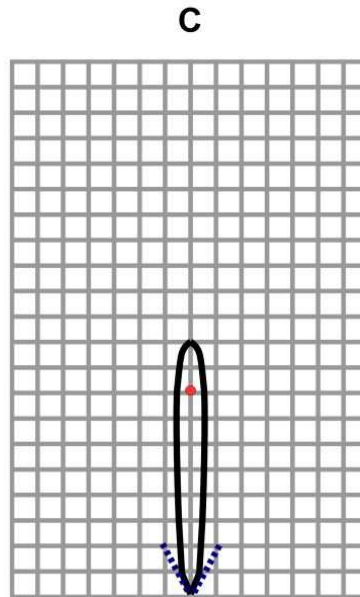
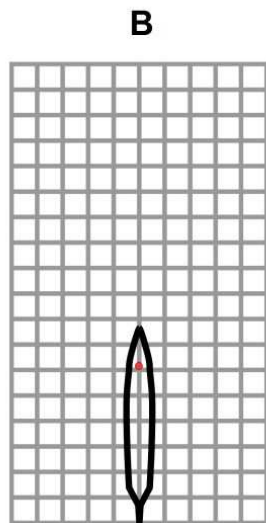
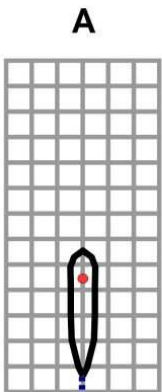

Beam Characteristics are Approximate

Beam Pattern drawn to a 1:95 scale for easy comparison to our other products.

MB7360-MB7380

Features and Benefits

- Factory calibrated beam width
- Low operating voltages from 2.7V to 5.5V
- All range outputs are active simultaneously
- High acoustic sensitivity

MB7360-MB7380

Applications and Uses

- Autonomous Navigation
- Robot Ranging Sensor
- Bin Level Measurement
- Tank Level Measurement

MB7363-MB7383 HRXL-MaxSonar®-WRLS™ Beam Pattern and Uses

The HRXL-MaxSonar-WRLS sensors are 10 meter sensors with a higher sensitivity than other HRXL-MaxSonar-WR products. This sensor is recommended for applications in which objects do not reflect enough ultrasonic sound for other sensors to report the range to, such as snow, people, and grain.

MB7363-MB7383

HRXL-MaxSonar® -WRLS/WRLST™ Beam Pattern

Sample results for measured beam pattern are shown on a 30-cm grid. The detection pattern is shown for dowels of varying diameters that are placed in front of the sensor

A 6.1-mm (0.25-inch) diameter dowel

B 2.54-cm (1-inch) diameter dowel

C 8.89-cm (3.5-inch) diameter dowel

D 11-inch wide board moved left to right with the board parallel to the front sensor face.

This shows the sensor's range capability.

■ ■ Partial Detection

— 5.0 V

● 3.3 V

— 2.7 V

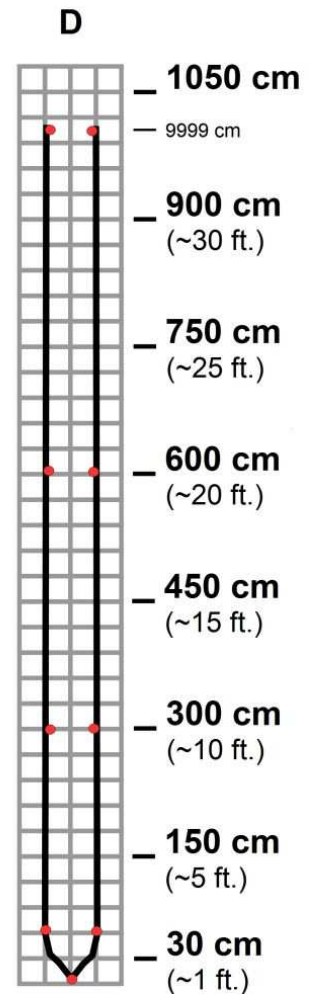
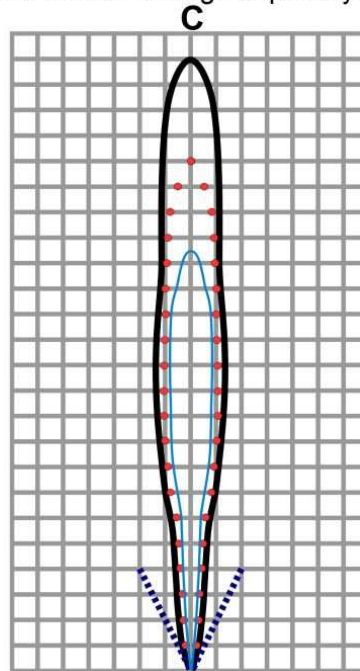
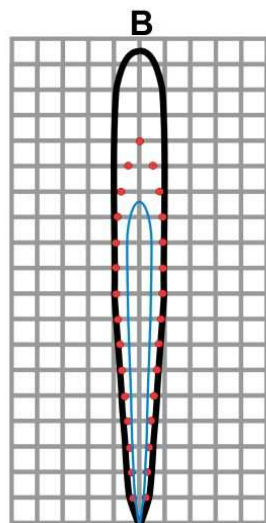
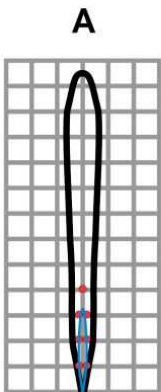

Beam Characteristics are Approximate

Beam Pattern drawn to a 1:95 scale for easy comparison to our other products.

MB7363-MB7383

Features and Benefits

- Factory calibrated beam width
- Low operating voltages from 2.7V to 5.5V
- All range outputs are active simultaneously
- High acoustic sensitivity

MB7363-MB7383

Applications and Uses

- Autonomous Navigation
- Robot Ranging Sensor
- Bin Level Measurement
- Tank Level Measurement
- Snow Level Measurement

MB7366-MB7386 HRXL-MaxSonar® -WRL™ Beam Pattern and Uses

The HRXL-MaxSonar-WRL sensors are a long range, 10 meter ultrasonic sensor.

MB7366-MB7386

HRXL-MaxSonar® -WRL/WRLT™ Beam Pattern

Sample results for measured beam pattern are shown on a 30-cm grid. The detection pattern is shown for dowels of varying diameters that are placed in front of the sensor

A 6.1-mm (0.25-inch) diameter dowel

B 2.54-cm (1-inch) diameter dowel

C 8.89-cm (3.5-inch) diameter dowel

D 11-inch wide board moved left to right with the board parallel to the front sensor face.

This shows the sensor's range capability.

Note: For people detection the pattern typically falls between charts A and B.

■ Partial Detection

— 5.0 V

● 3.3 V

— 2.7 V

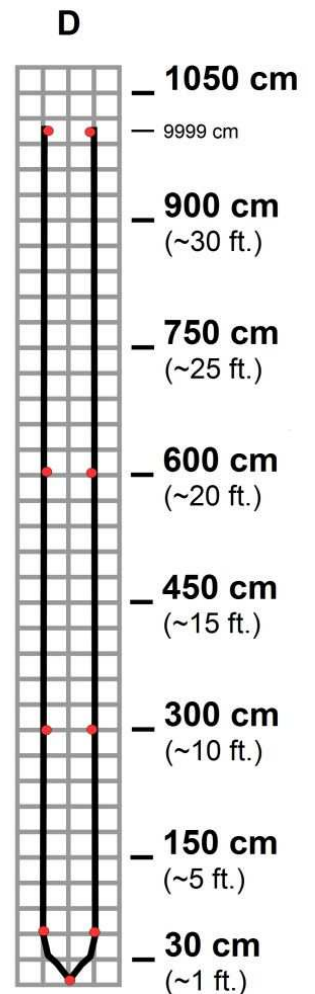
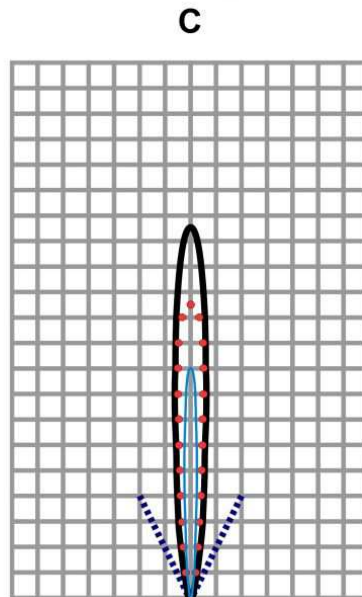
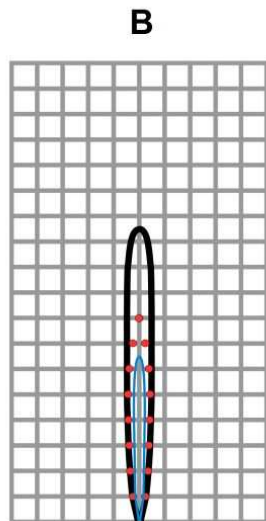
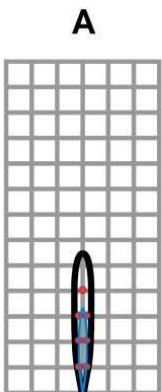

Beam Characteristics are Approximate

Beam Pattern drawn to a 1:95 scale for easy comparison to our other products.

MB7366-MB7386

Features and Benefits

- Factory calibrated beam width
- Low operating voltages from 2.7V to 5.5V
- All range outputs are active simultaneously
- 10 meter range to large targets

MB7366-MB7386

Applications and Uses

- Autonomous Navigation
- Robot Ranging Sensor
- Bin Level Measurement
- Tank Level Measurement
- Long Range Measurement

MB7369-MB7389 HRXL-MaxSonar® -WRM™ Beam Pattern and Uses

The HRXL-MaxSonar-WRM product line has a narrow sensor beam and advance filtering that ranges to targets with the largest ultrasonic reflection, while ignoring smaller clutter.

MB7369-MB7389

HRXL-MaxSonar® -WRM/WRMT™ Beam Pattern

Sample results for measured beam pattern are shown on a 30-cm grid. The detection pattern is shown for dowels of varying diameters that are placed in front of the sensor.

A 6.1-mm (0.25-inch) diameter dowel

B 2.54-cm (1-inch) diameter dowel

C 8.89-cm (3.5-inch) diameter dowel

D 11-inch wide board moved left to right with the board parallel to the front sensor face.

This shows the sensor's range capability.

Note: For people detection the pattern typically falls between charts A and B.

■ Partial Detection

— 5.0 V

● 3.3 V

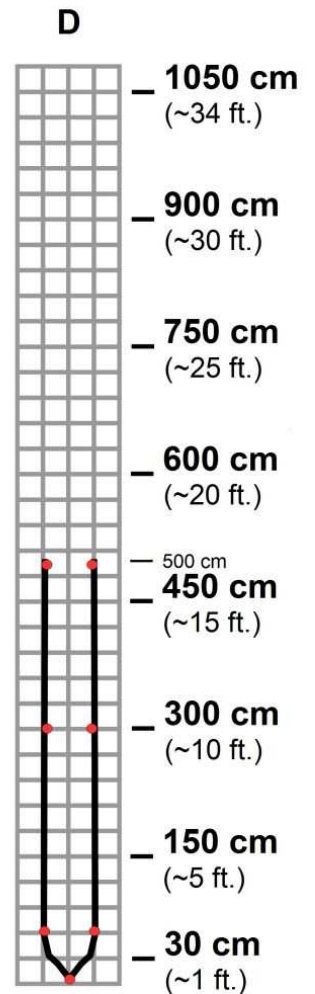
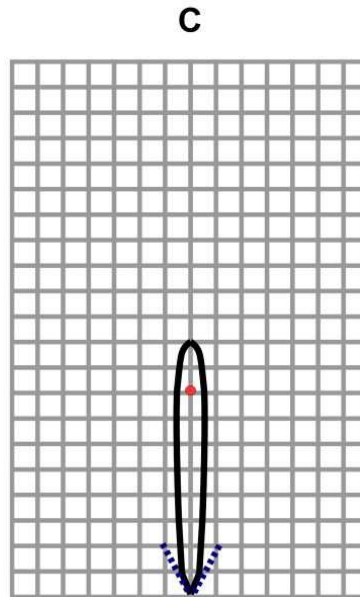
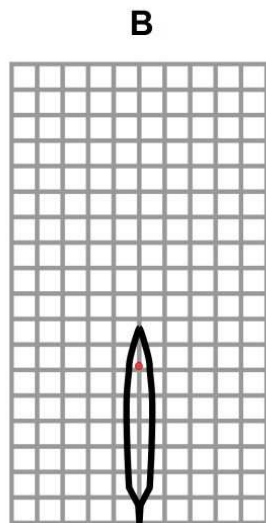
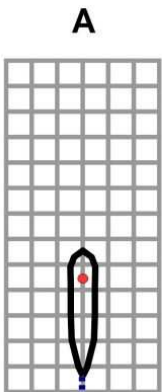

Beam Characteristics are Approximate

Beam Pattern drawn to a 1:95 scale for easy comparison to our other products.

MB7369-MB7389

Features and Benefits

- Factory calibrated beam width
- Low operating voltages from 2.7V to 5.5V
- All range outputs are active simultaneously
- Superior clutter rejection

MB7369-MB7389

Applications and Uses

- Bin Level Measurement
- Tank Level Measurement

MB7367-MB7387 HRXL-MaxSonar® -WRC/WRCT™ Beam Pattern and Uses

The HRXL-MaxSonar-WRC product line offer a more compact housing for use in applications where there are mounting or weight restrictions.

MB7367-MB7387

HRXL-MaxSonar® -WRCR/WRCT™ Beam Pattern

Sample results for measured beam pattern are shown on a 30-cm grid. The detection pattern is shown for dowels of varying diameters that are placed in front of the sensor.

A 6.1-mm (0.25-inch) diameter dowel

B 2.54-cm (1-inch) diameter dowel

C 8.89-cm (3.5-inch) diameter dowel

D 11-inch wide board moved left to right with the board parallel to the front sensor face.

This shows the sensor's range capability.

Note: For people detection the pattern typically falls between charts A and B.

— 5.0 V

● 3.3 V

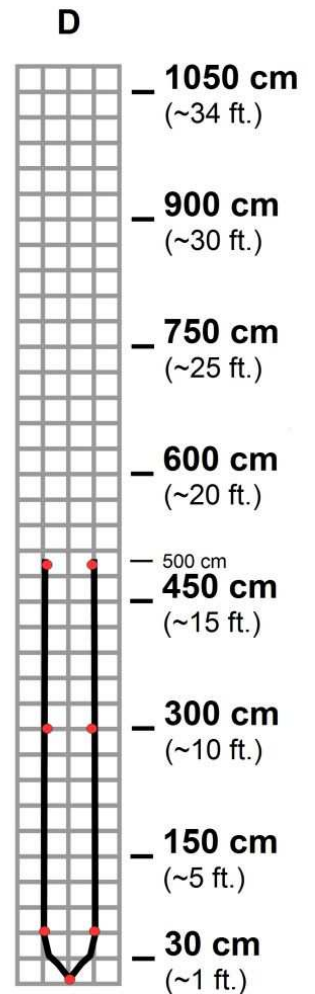
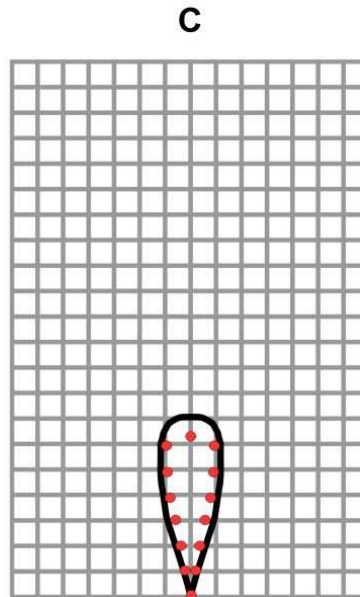
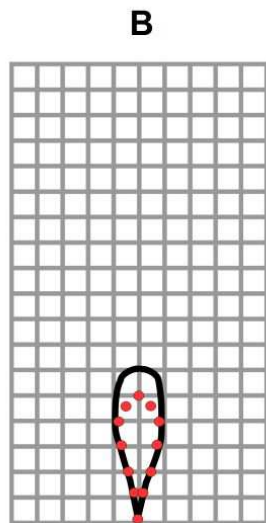
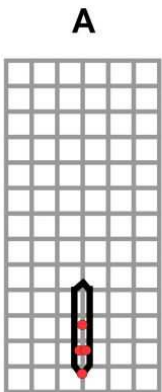

Beam Characteristics are Approximate

Beam Pattern drawn to a 1:95 scale for easy comparison to our other products.

MB7367-MB7387

Features and Benefits

- Extra Compact Housing
- Designed for outdoor or indoor environments
- Lightweight, compact, weather resistant design
- Low cost IP67 sensor
- Reliable and stable range data

MB7367-MB7387

Applications and Uses

- Applications with strict mounting conditions

Have the right MaxSonar® for your application?

Check out our MaxSonar® Product Lines

Indoor Use

(or protected environments)

Outdoor Use

(or rugged environments) IP67

1 mm Resolution
HRLV-MaxSonar-EZ

1 in Resolution
LV-MaxSonar-EZ
LV-ProxSonar-EZ

1 cm Resolution
XL-MaxSonar-EZ
XL-MaxSonar-AE
XL-MaxSonar-EZL
XL-MaxSonar-AEL
I2CXL-MaxSonar-EZ

1 mm Resolution
HRUSB-MaxSonar-EZ

1in Resolution
USB-ProxSonar-EZ

1 mm Resolution
HRXL-MaxSonar-WR
HRXL-MaxSonar-WRT
HRXL-MaxSonar-WRM
HRXL-MaxSonar-WRMT
HRXL-MaxSonar-WRL
HRXL-MaxSonar-WRLT
HRXL-MaxSonar-WRLS
HRXL-MaxSonar-WRLST

1 cm Resolution
XL-MaxSonar-WR
XL-MaxSonar-WRL
XL-MaxSonar-WRA
XL-MaxSonar-WRLA
I2CXL-MaxSonar-WR

1 mm Resolution
HRXL-MaxSonar-WRC
HRXL-MaxSonar-WRCT

1 cm Resolution
XL-MaxSonar-WRC
XL-MaxSonar-WRCA
I2CXL-MaxSonar-WRC

F-Option Available for all WR models. For additional protection when necessary in hazardous chemical environments.

Accessories-More information available online

MB7954 - Shielded Cable

The MaxSonar Connection Wire is used to reduce interference caused by electrical noise on the lines. This cable is a great solution to use when running the sensors at a long distance or in an area with a lot of EMI and electrical noise.



MB7950 - XL-MaxSonar-WR Mounting Hardware

The MB7950 Mounting Hardware is selected for use with our outdoor ultrasonic sensors. The mounting hardware includes a steel lock nut and two O-ring (Buna-N and Neoprene) each optimal for different applications.



MB7955 / MB7956 / MB7957 / MB7958 / MB7959 - HR-MaxTemp

The HR-MaxTemp is an optional accessory for the HR-MaxSonar. The HR-MaxTemp connects to the HR-MaxSonar for automatic temperature compensation without self heating.



MB7961 - Power Supply Filter

The power supply filter is recommended for environments with unclean power or electrical noise.



MB7962 / MB7963 / MB7964 / MB7965 - Micro-B USB Connection Cable

The MB7962, MB7963, MB7964, and MB7965 Micro-B USB cables are USB2.0 compliant and backwards compatible with USB 1.0 standards. Varying lengths.



Product / specifications subject to change without notice. The names MaxBotix®, MaxSonar®, EZ, E20, E21, E22, E23, E24, HR, AE0, AE1, AE2, AE3, AE4, WR1, and WRC1 are trademarks of MaxBotix Inc.