

## DETAILS

<b>Product Number</b>	C13239_HB-2X2-M-BLIND
<b>Family</b>	HB
<b>Type</b>	Lens array
<b>Color</b>	clear
<b>Diameter</b>	50x50 mm
<b>Height</b>	8,5 mm
<b>Style</b>	square
<b>Optic Material</b>	PMMA
<b>Holder Material</b>	
<b>Fastening</b>	glue, pin
<b>Status</b>	production ready
<b>ROHS Compliant</b>	Yes
<b>Date Updated</b>	21/04/2016

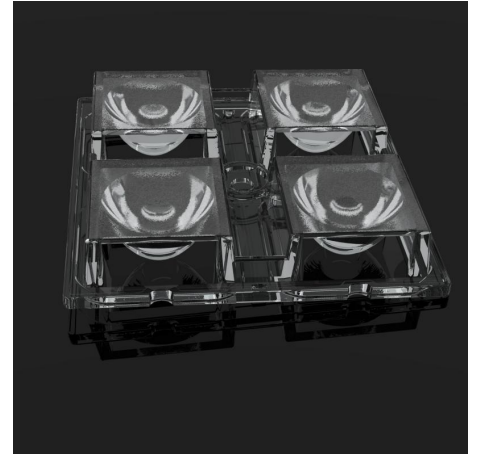

## OPTICAL PROPERTIES

LED	Viewing Angle	Light Beam	Efficiency	cd/lm	Connector
XT-E	25 deg	Medium	92 %	3.700	-
XP-G	31 deg	Medium	91 %	3.100	-
XP-G2	33 deg	Medium	93 %	3.400	-
H35C1 (LEMWA33)	29 deg	Medium	91 %	3.400	-
LUXEON Z ES	21 deg	Medium	91 %	5.640	-
LUXEON Q	26 deg	Medium	94 %	3.600	-
NVSxx19B/NVSxx19C	29 deg	Medium	91 %	3.100	-
Oslon Square PC	30 deg	Medium	91 %	3.400	-
Oslon Square Gen3	sim: 32	Medium	sim: 93 %	sim: 3.970	-
LH351Z	32 deg	Medium	93 %	2.900	-
Z5M1/Z5M2	30 deg	Medium	90 %	3.400	-
TL1L4	25 deg	Medium	85 %	3.500	-
RLE G1 49x223mm 4000lm xxx EXC OT	29 deg	Medium	94 %	3.000	-
RLE G1 49x245mm 4000lm xxx EXC OT	29 deg	Medium	94 %	3.000	-
RLE G1 49x121mm 2000lm xxx EXC OT	29 deg	Medium	94 %	3.000	-
RLE G1 49x133mm 2000lm xxx EXC OT	29 deg	Medium	94 %	3.000	-

D

C

B

A

4

4

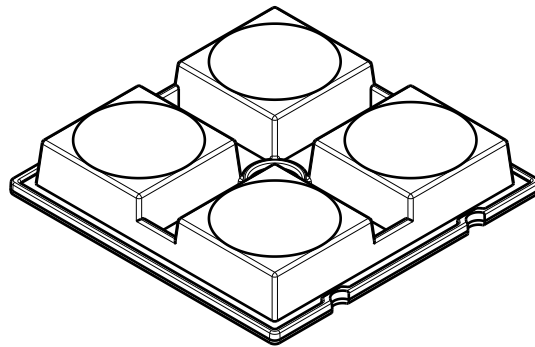
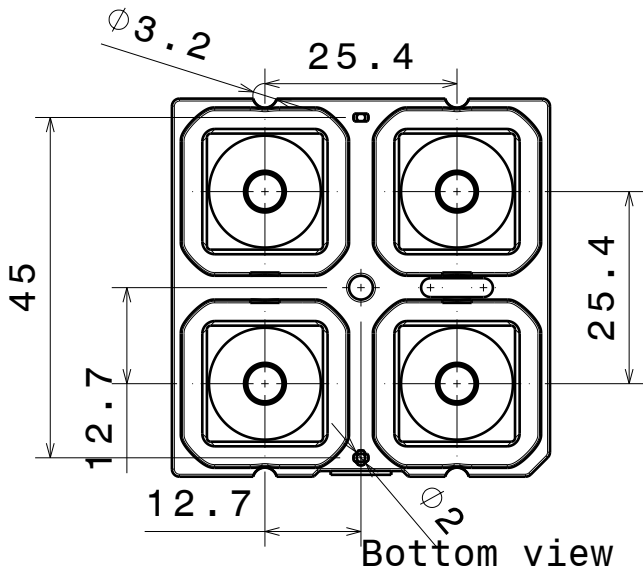

3

3

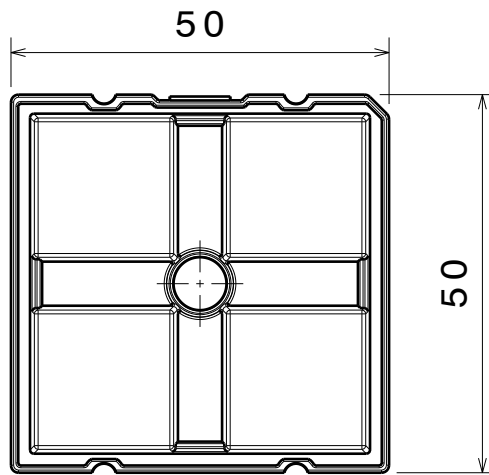
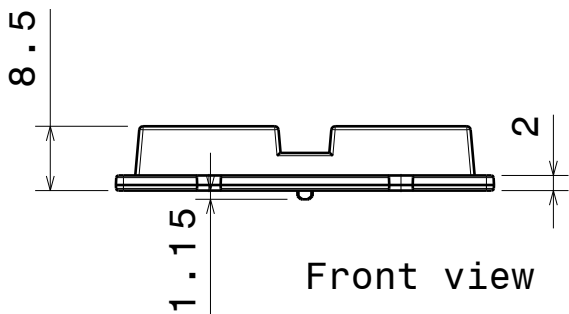

2

2

INDEX	PART NO	DESCRIPTION	MATERIAL	COLOUR
1	C13239	HB-2X2-M-BLIND	PMMA	

Tolerances if not otherwise shown  
According to DIN ISO 2768-1  
Linear measures:  
Up to 30mm class M, otherwise class C.  
According to DIN ISO 2768-2  
Form and position: class L

**LEDiL**  
Ledil Oy  
Salorankatu 10  
FIN 24240 SALO  
Finland

THIRD ANGLE PROJECTION:

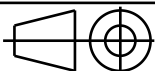

DRAWING TITLE

**HB-2X2-M-BLIND**

This drawing is the property of LEDiL Oy. It may not be reproduced, copied or communicated without a written agreement with LEDiL Oy."

SIZE  
**A4**

**C13239**

SCALE 1:1 WEIGHT

SHEET 1/1

1

1

D

A

Luminaire: Ledil Oy C13233\_HB-2x2-M (Cree XT-E 390lm @ 250mA) Efficiency=92%  
Lamps: 1 x Cree XT-E 390lm @ 250mA

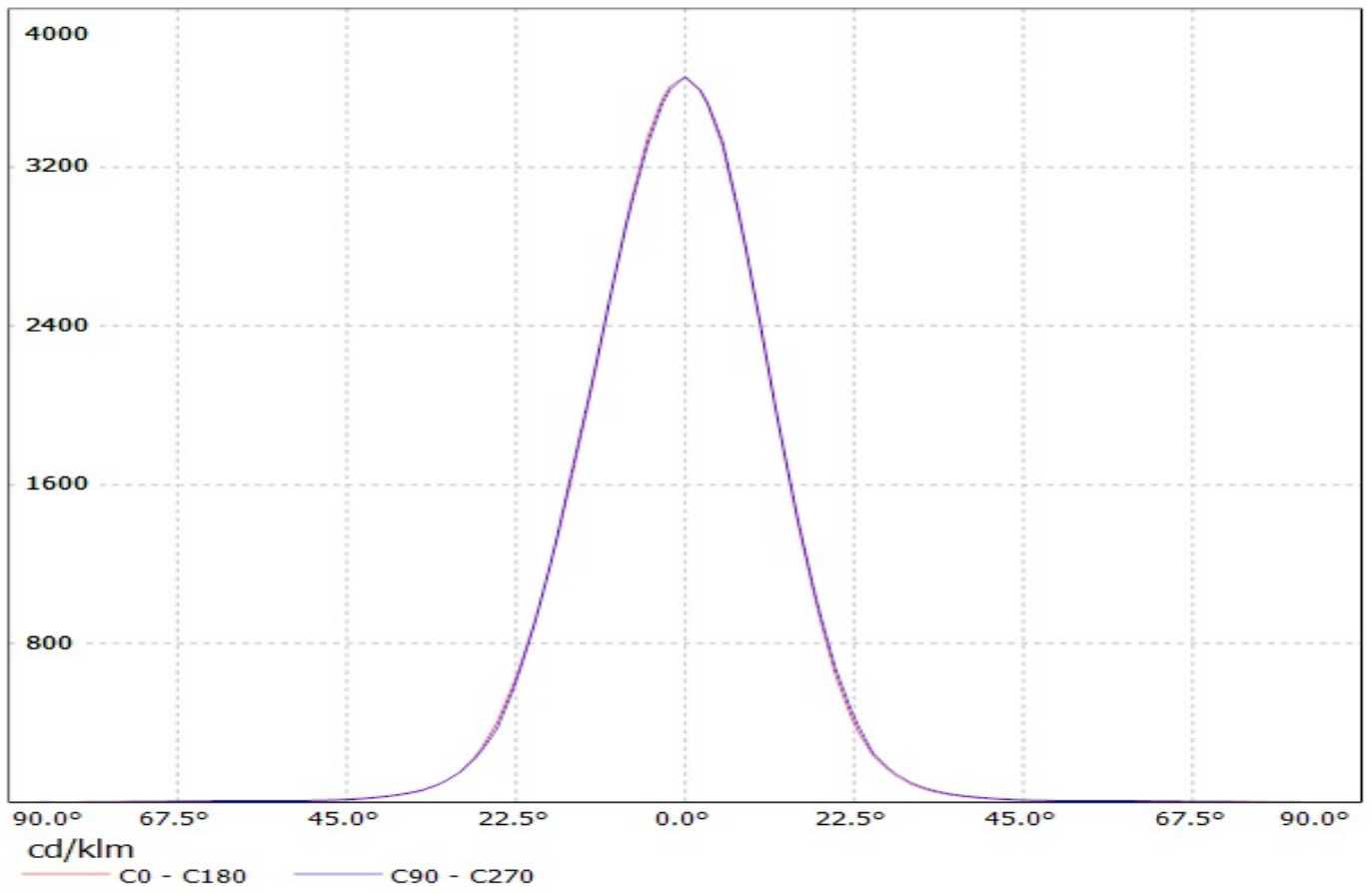

Luminaire: Ledil Oy C13233\_HB-2x2-M (Cree XP-G 257lm @ 250mA) Efficiency=91%  
Lamps: 1 x Cree XP-G 257lm @ 250mA

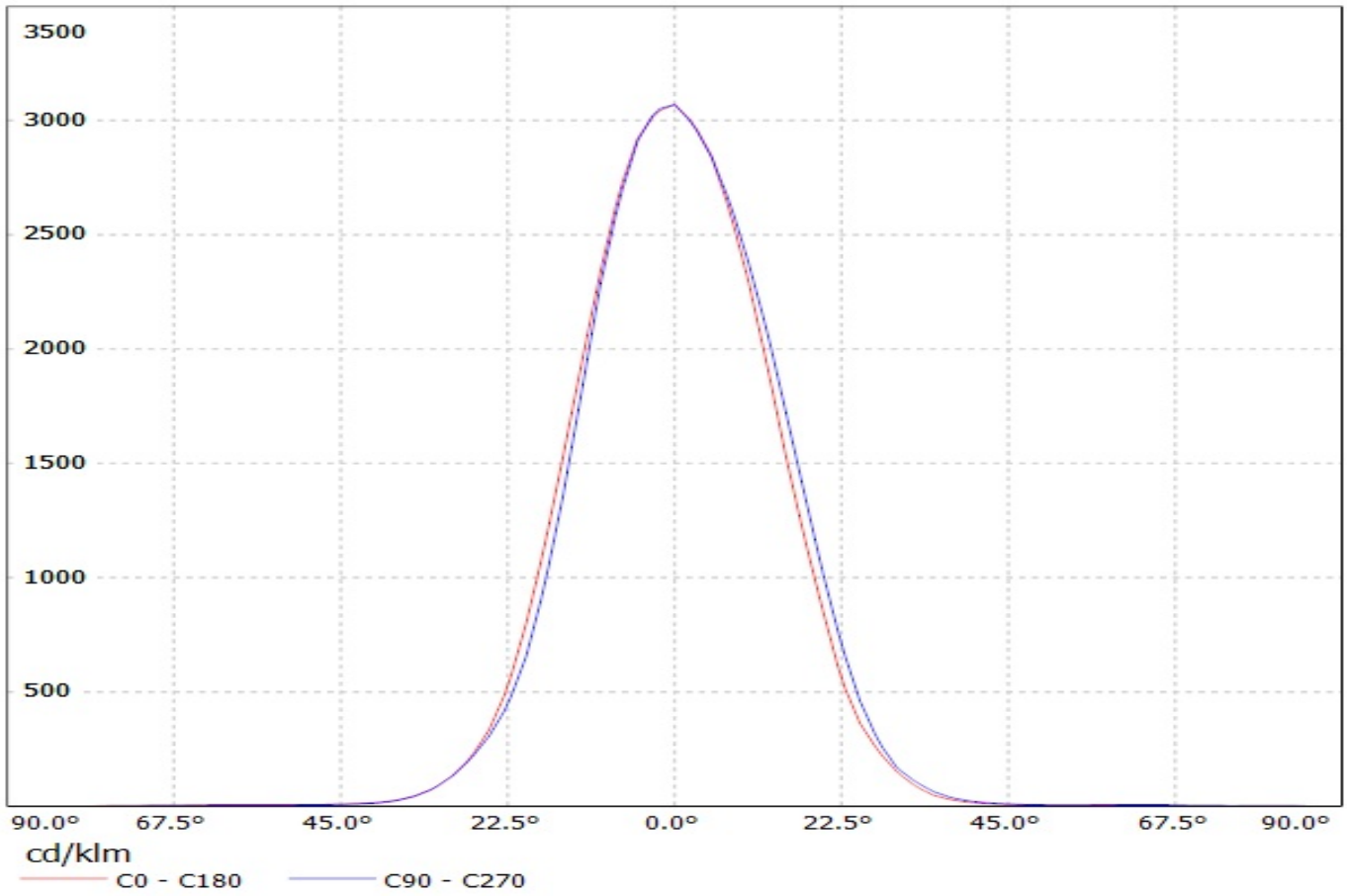

Luminaire: Ledil Oy C13233\_HB-2x2-M (Cree XP-G2 420lm @ 250mA) Efficiency=93%  
Lamps: 1 x Cree XP-G2 420lm @ 250mA

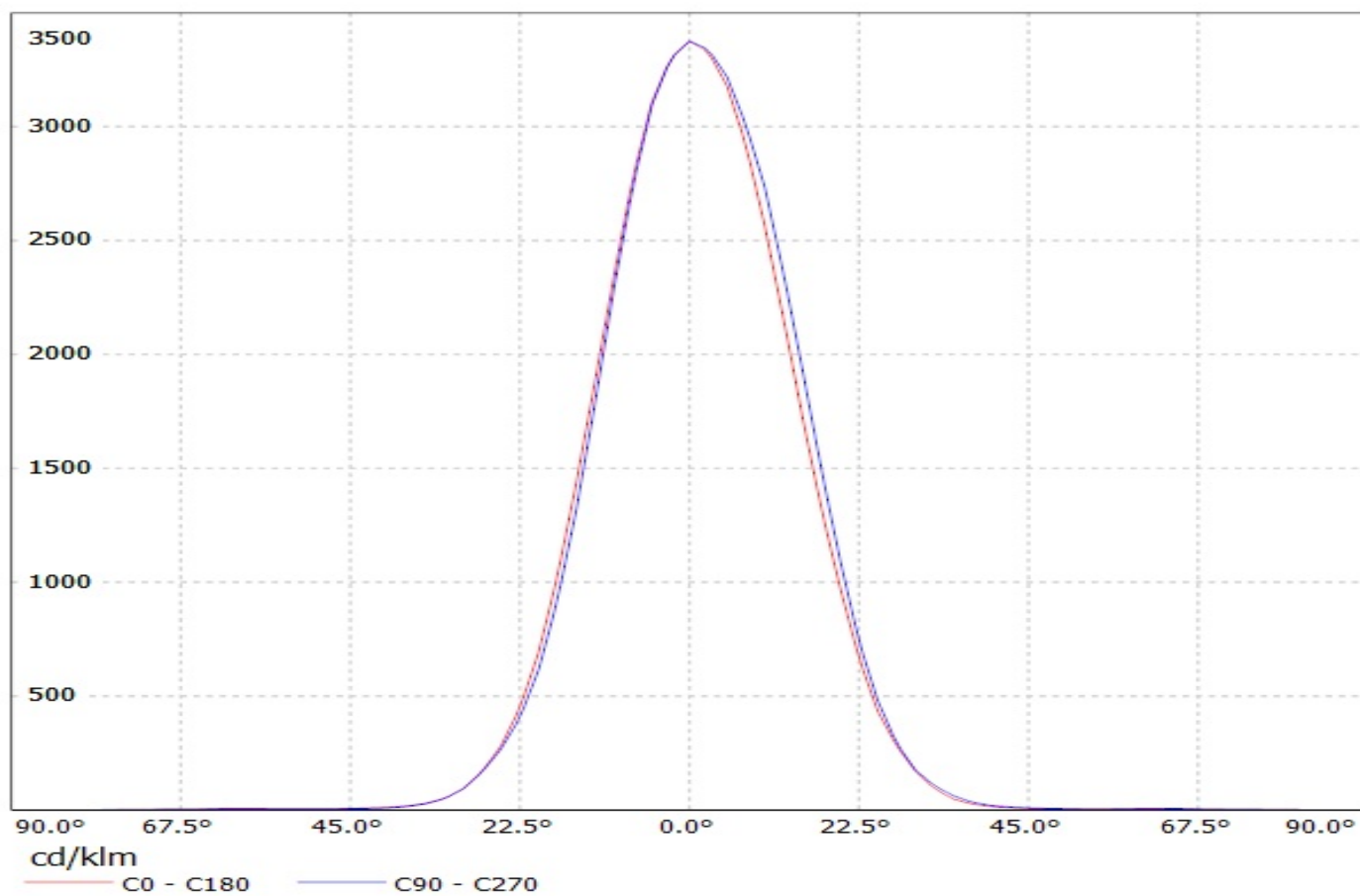

Luminaire: Ledil Oy C13239\_HB-2X2-M-BLIND\_(3535\_Ceramic\_gen2) Efficiency=91%  
Lamps: 1 x LG 3535 Ceramic gen2 (PKG5700K) 461lm @ 250mA CCT=6600K P=2.9W I=250mA

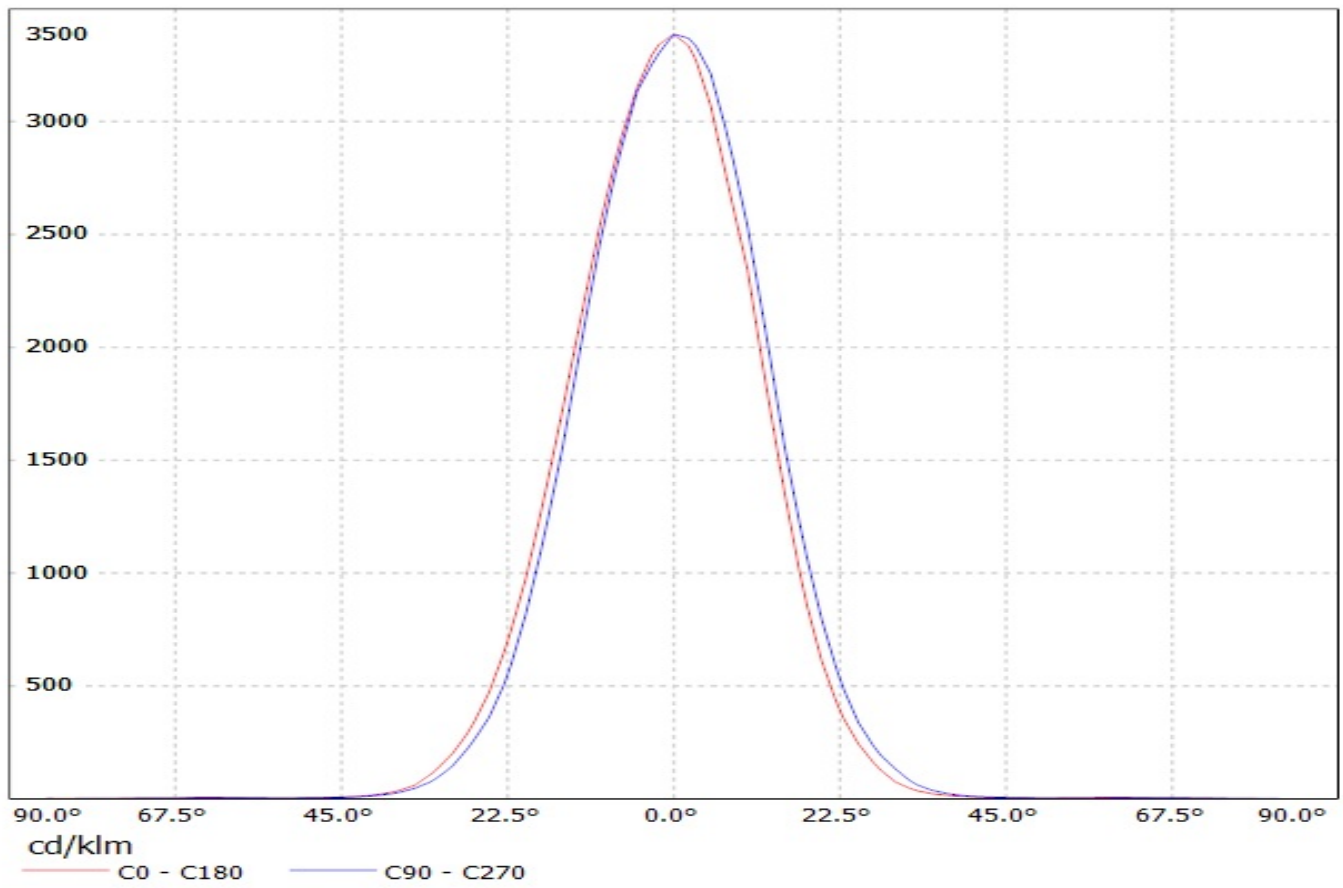

Luminaire: Ledil Oy C13239\_HB-2X2-M-BLIND\_(Luxeon\_Z\_ES) Efficiency=91%  
Lamps: 1 x Luxeon Z ES (LXZ2-3090) 209lm @ 250mA CCT=3000K P=2.8W I=250mA

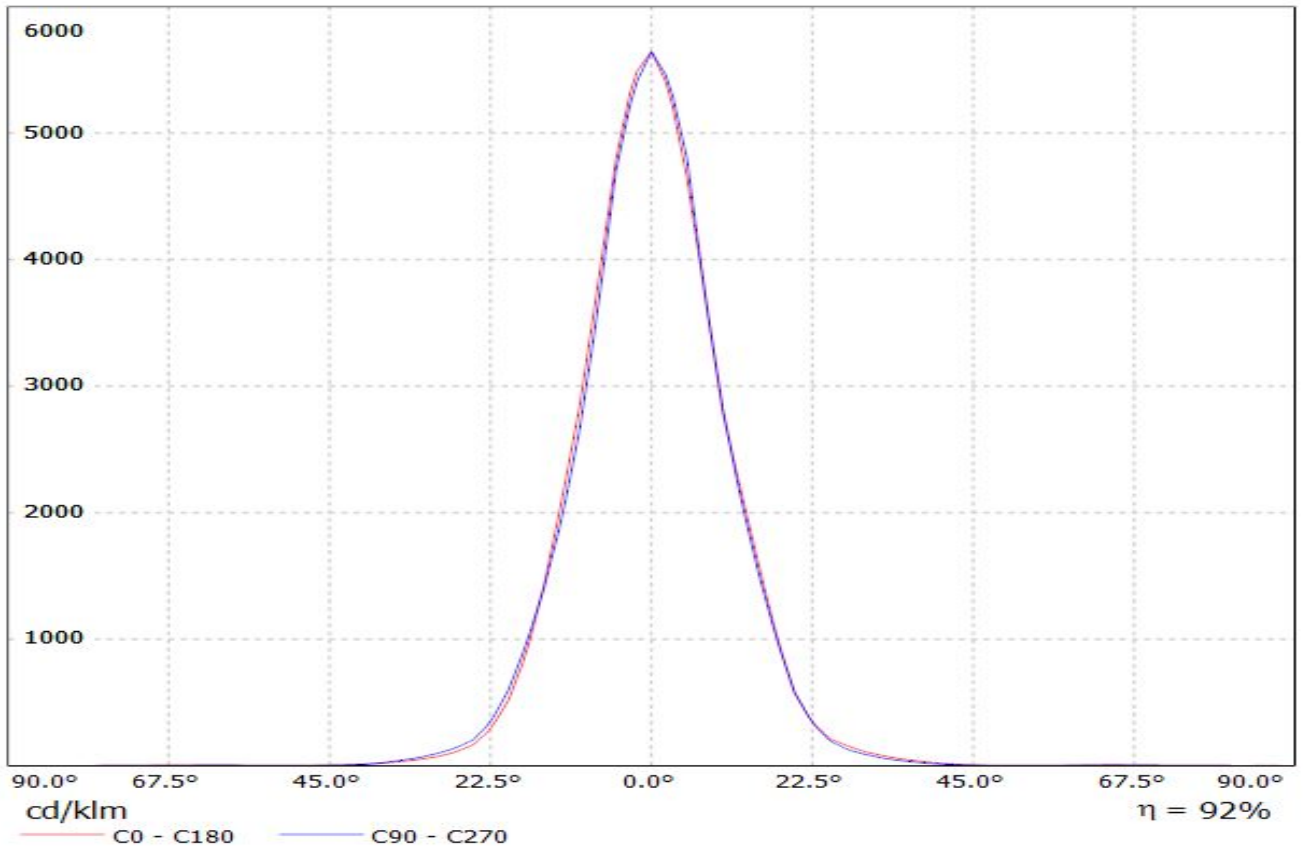

Luminaire: LEDiL Oy C13239\_HB-2X2-M-BLIND\_(LUXEON\_Q) Eff: 94%  
Lamps: 1 x LUXEON\_Q\_2x2\_(LHQ-3080)\_298.363lm@250mA\_P=2.87385W\_I=249.9mA

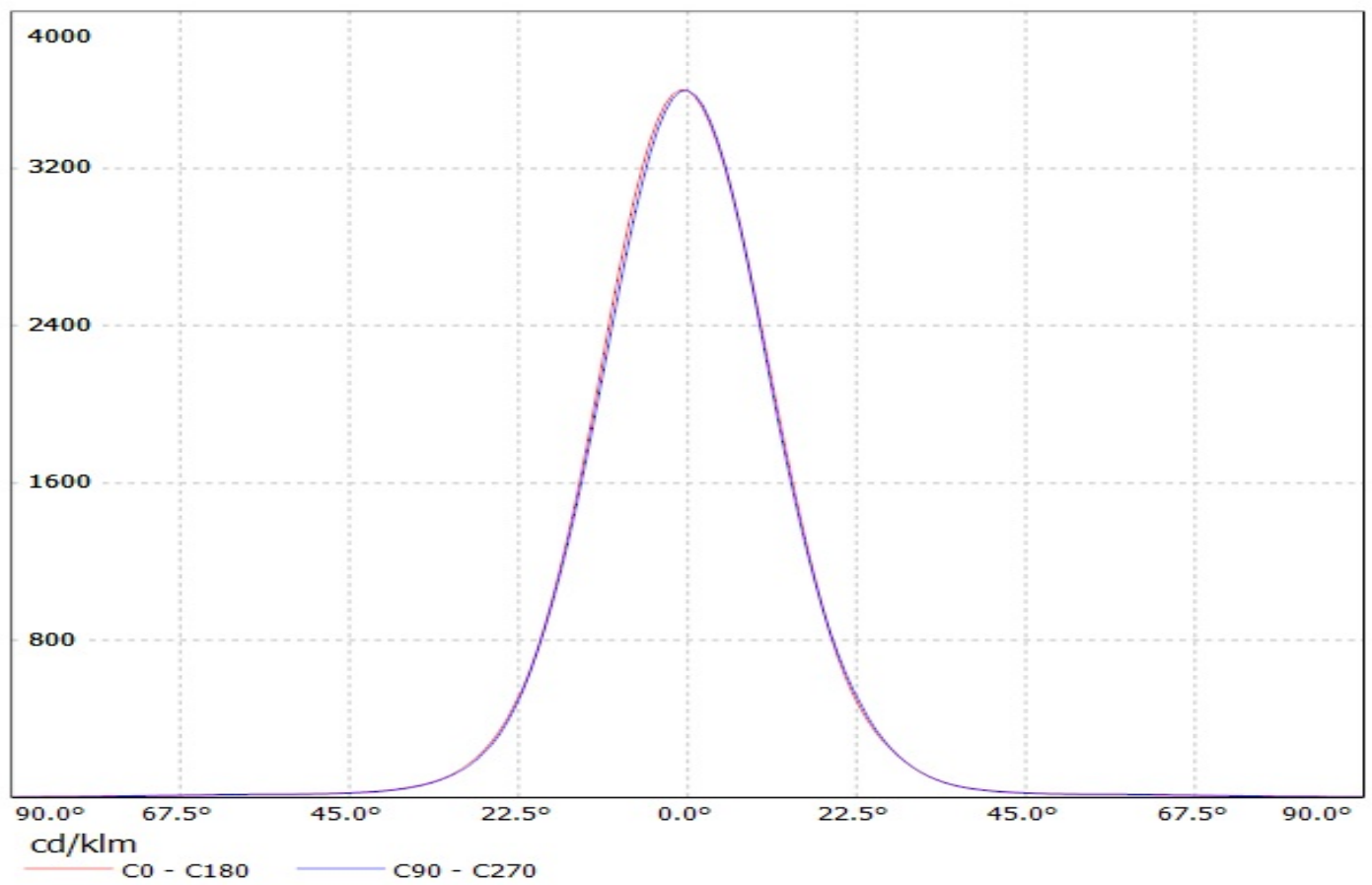



Luminaire: Ledil Oy C13233\_HB-2x2-M (Nichia 219B 306lm @ 250mA) Efficiency=91%  
Lamps: 1 x Nichia 219B 306lm @ 250mA

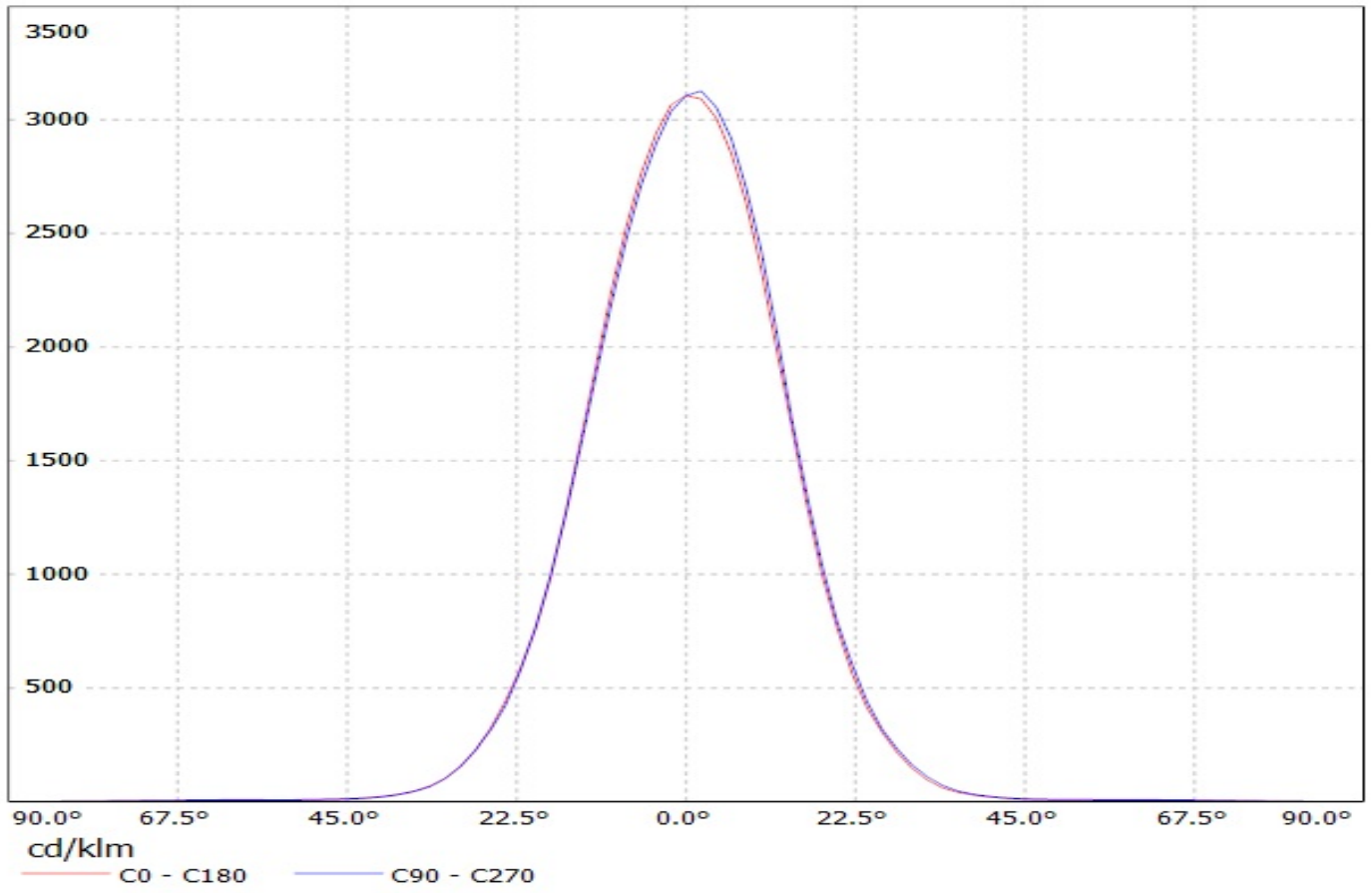

Luminaire: Ledil Oy C13239&C13233\_HB-2x2-M-SQPC (Osram Square PC 398lm @ 250mA) Efficiency=91%  
Lamps: 1 x Osram Square PC 398lm @ 250mA

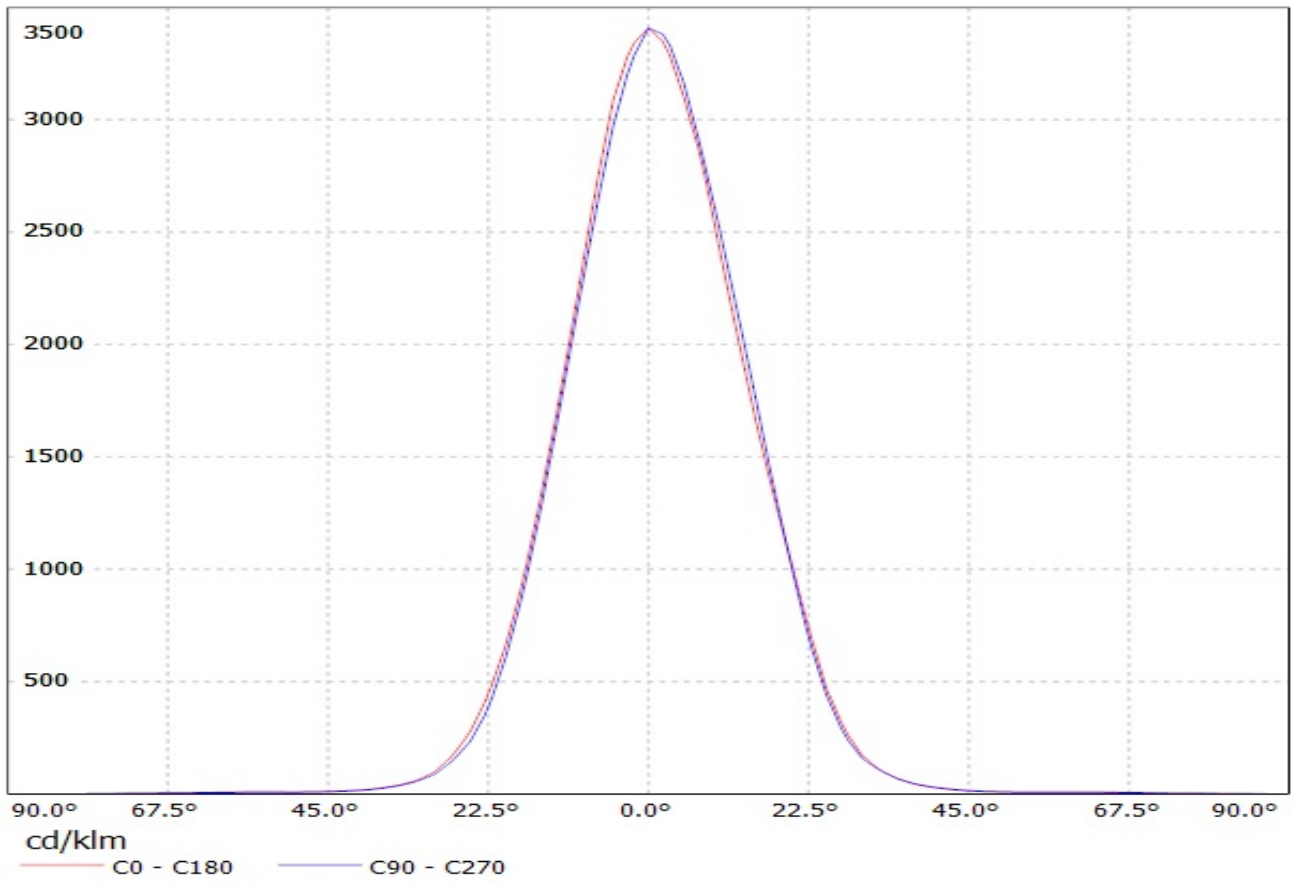

Luminaire: LEDiL Oy C13239\_HB-2X2-M-BLIND\_(LH351Z) Eff: 93%  
Lamps: 1 x SAMSUNG\_LH351Z\_2x2\_359.49lm@250mA\_P=2.86371W\_I=249.8mA

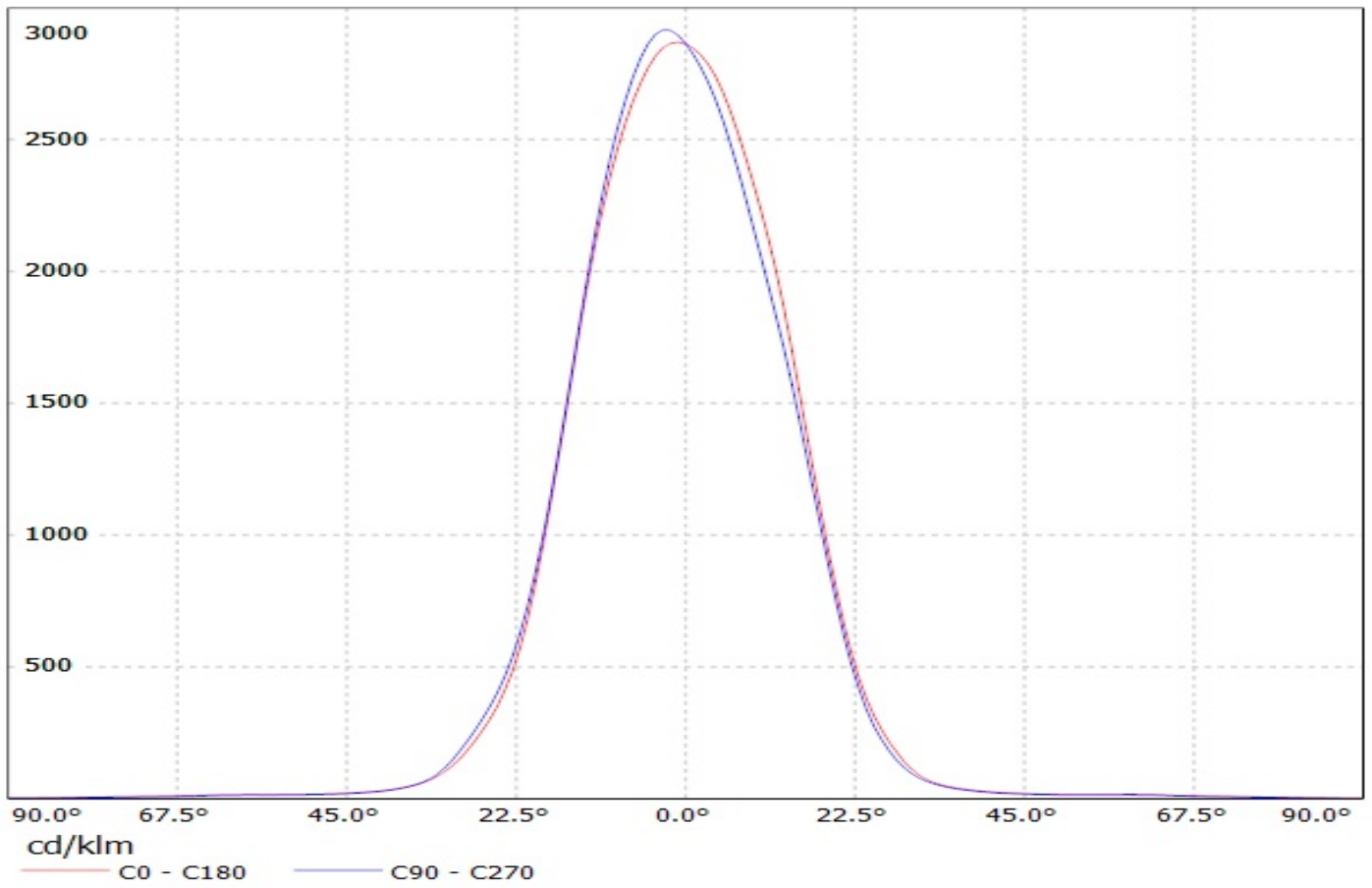

Luminaire: LEDil Oy C13239\_HB-2X2-M-BLIND\_(Z5M1) Efficiency=90%  
Lamps: 1 x Seoul Z5M1 (SZ5-M1-WN-C8) 379lm @ 250mA CCT=4600K P=2.9W I=250mA

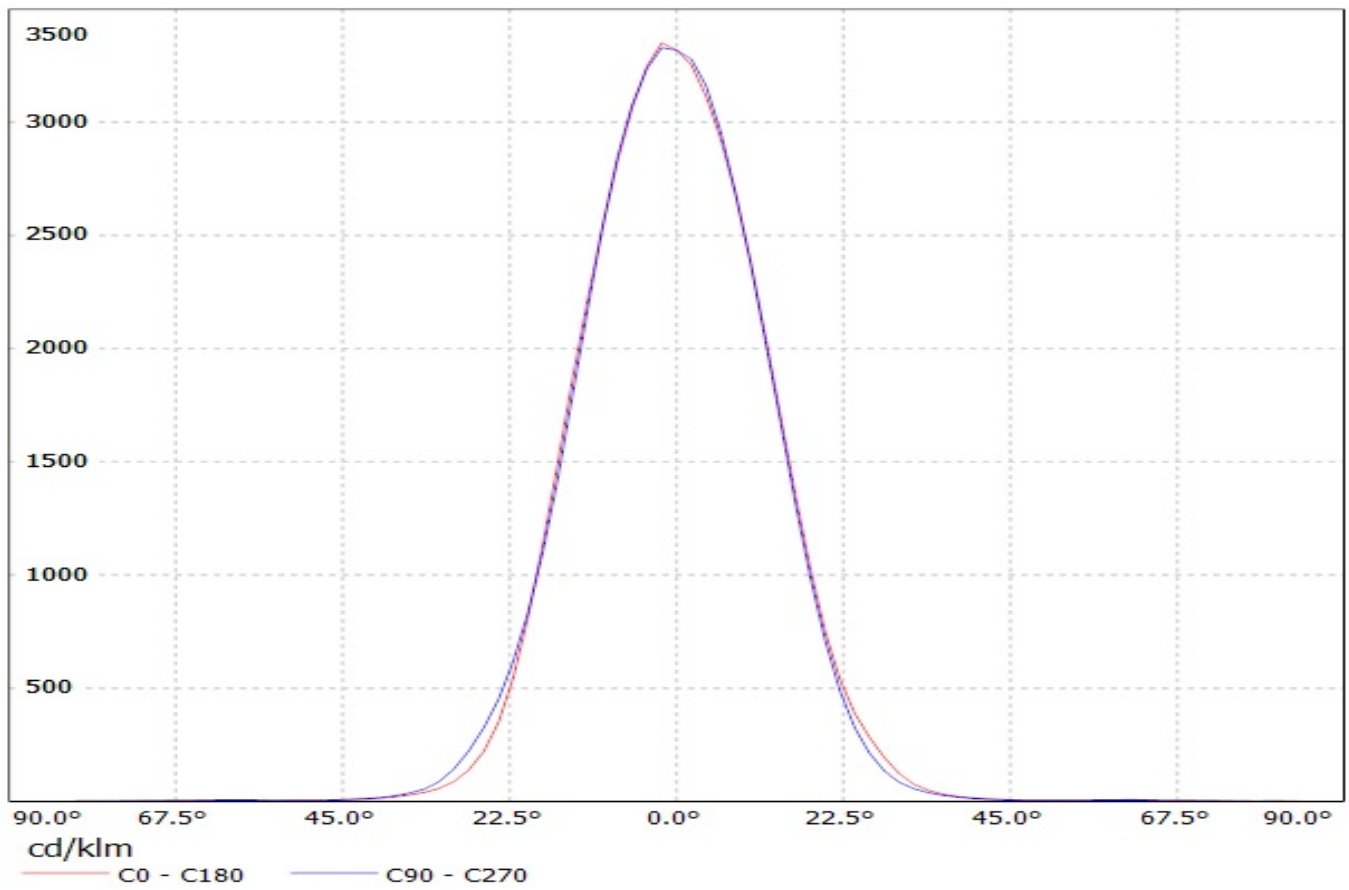

# Ledil C13239\_HB-2X2-M-BLIND\_(TL1L4) / LDC (Linear)

Luminaire: Ledil C13239\_HB-2X2-M-BLIND\_(TL1L4)

Lamps: 1 x Toshiba\_TL1L4\_2x2\_(TL1L4-DW0)\_472.639lm@250mA\_CCT=6500K\_P=2.9W\_I=0.25A

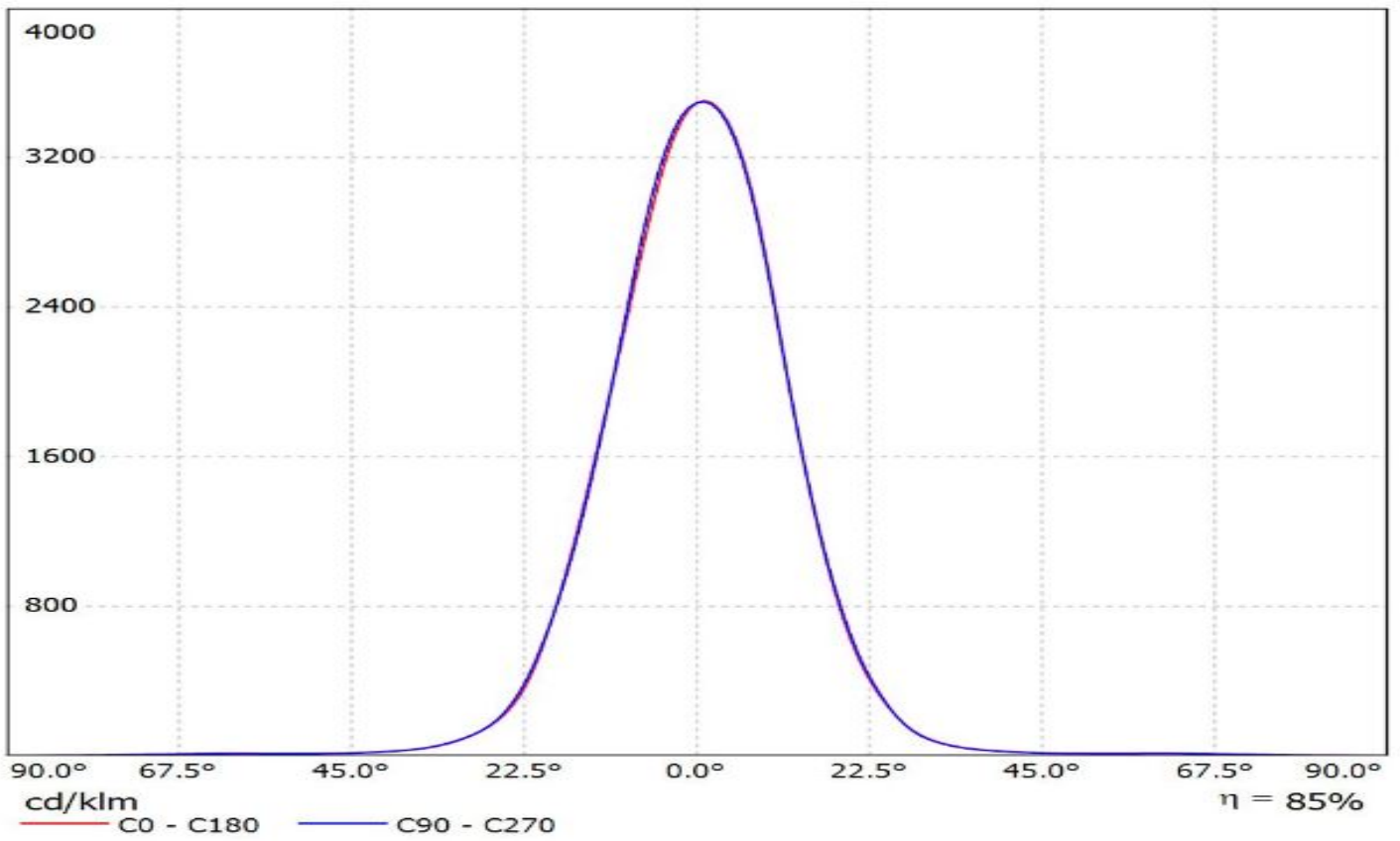

Luminaire: LEDiL Oy C13239\_HB-2X2-M-BLIND\_(Tridonic\_Module\_RLE\_G1)  
Lamps: 1 x Tridonic\_Module\_RLE\_G1\_4576.03lm@700mA\_P=32.0681W\_I=0.700A

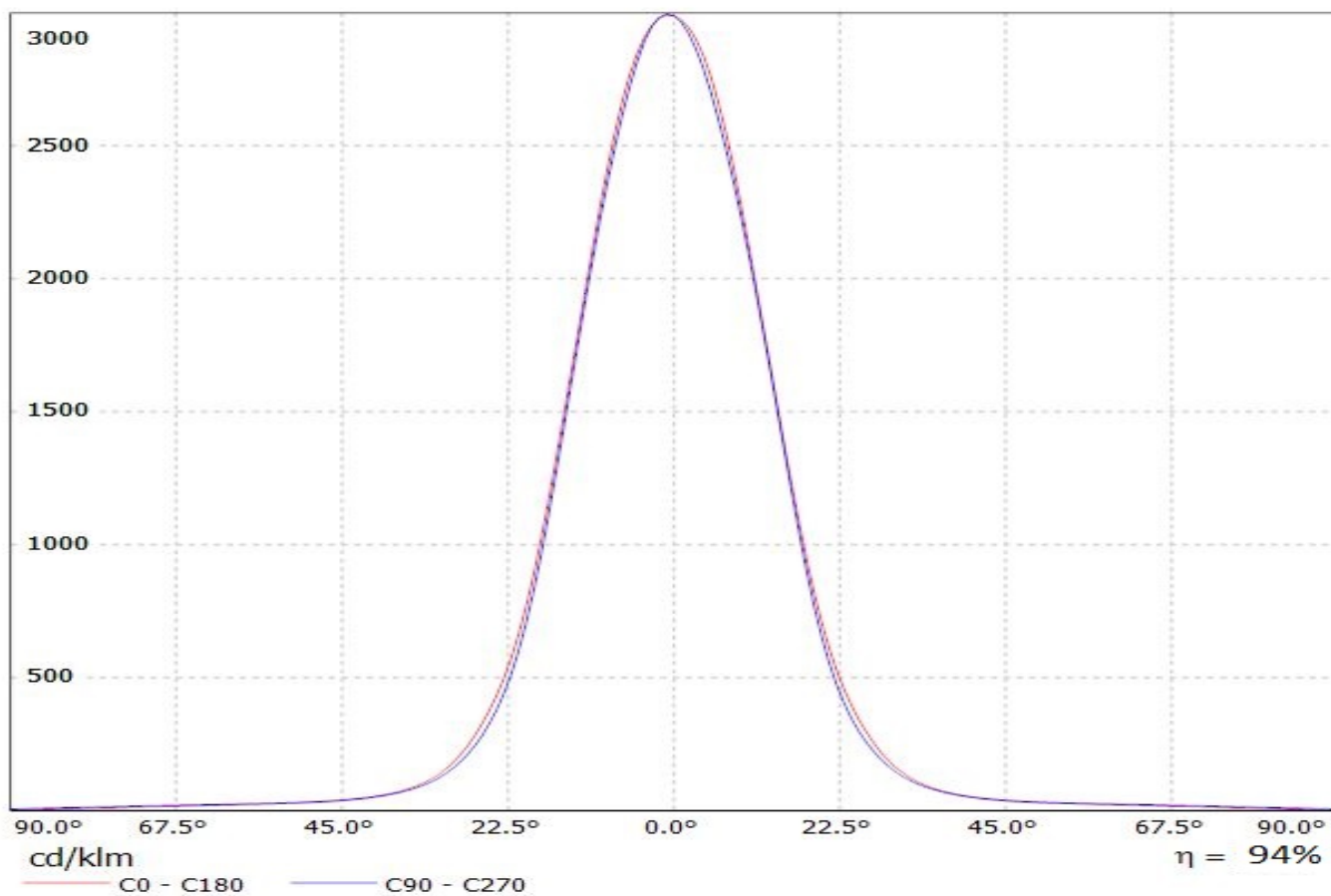

Luminaire: LEDiL Oy C13239\_HB-2X2-M-BLIND\_(Tridonic\_Module\_RLE\_G1)  
Lamps: 1 x Tridonic\_Module\_RLE\_G1\_4576.03lm@700mA\_P=32.0681W\_I=0.700A

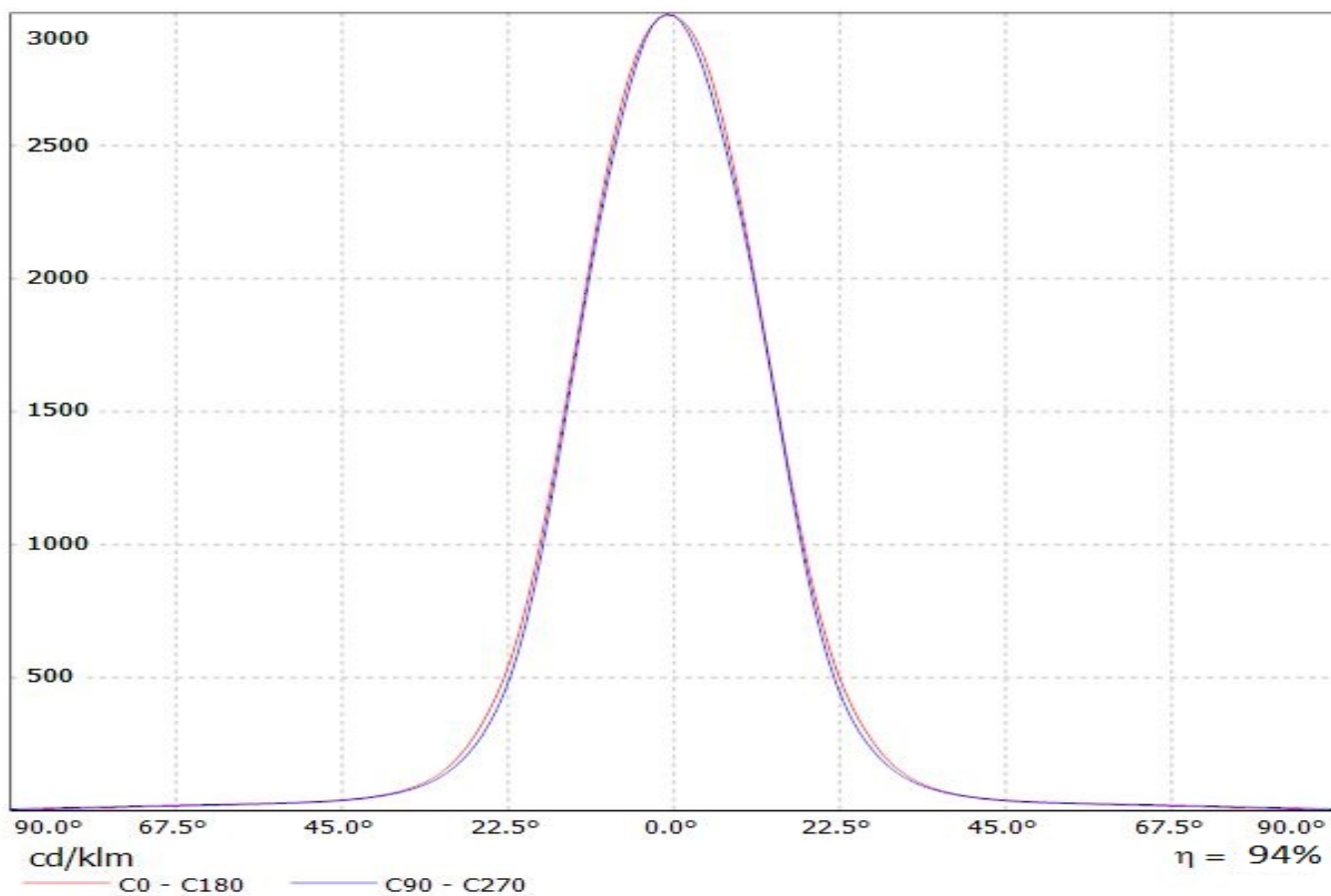

Luminaire: LEDiL Oy C13239\_HB-2X2-M-BLIND\_(Tridonic\_Module\_RLE\_G1)  
Lamps: 1 x Tridonic\_Module\_RLE\_G1\_2288lm@700mA\_P=16W\_I=0.700A

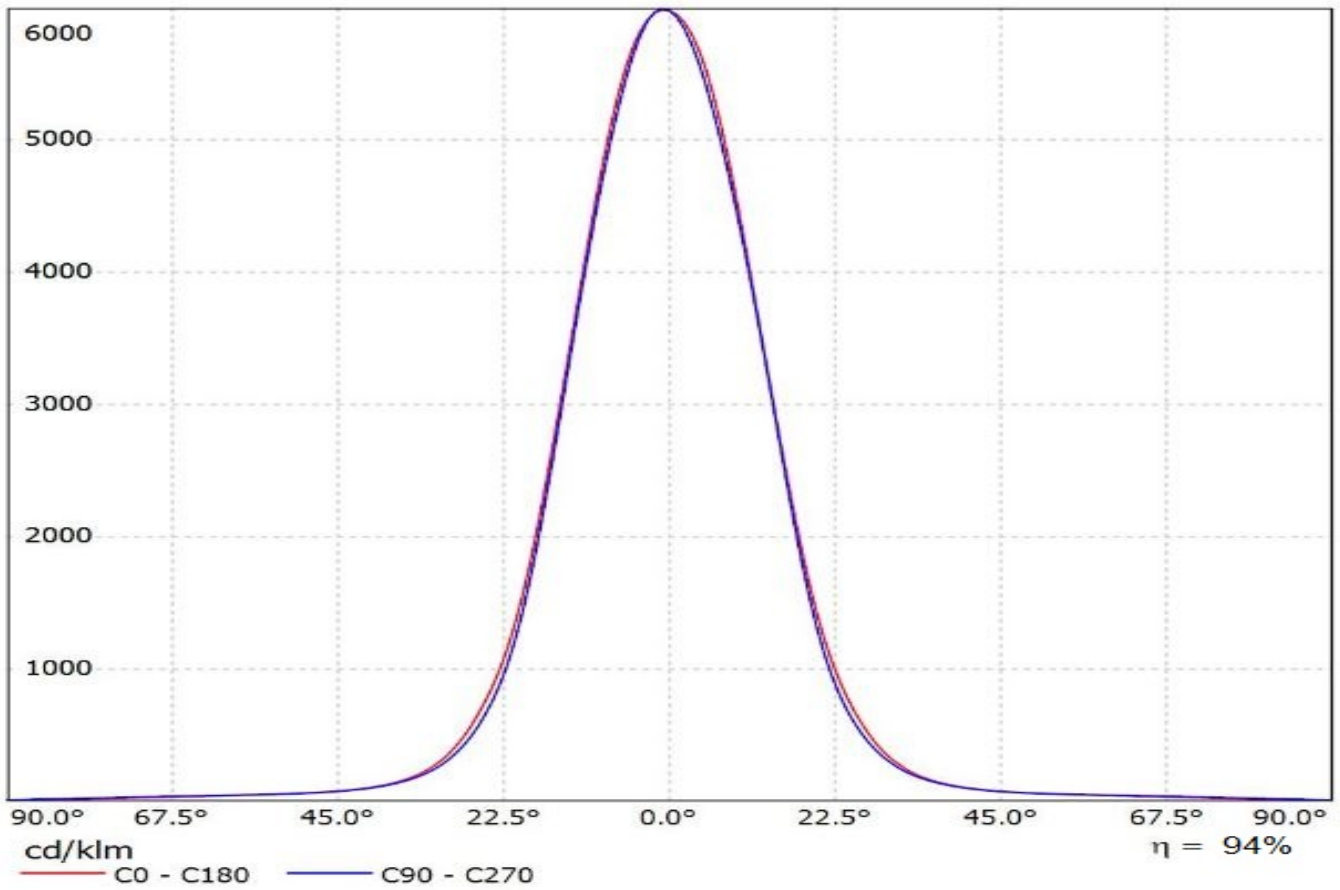



Luminaire: LEDiL Oy C13239\_HB-2X2-M-BLIND\_(Tridonic\_Module\_RLE\_G1)  
Lamps: 1 x Tridonic\_Module\_RLE\_G1\_2288lm@700mA\_P=16W\_I=0.700A

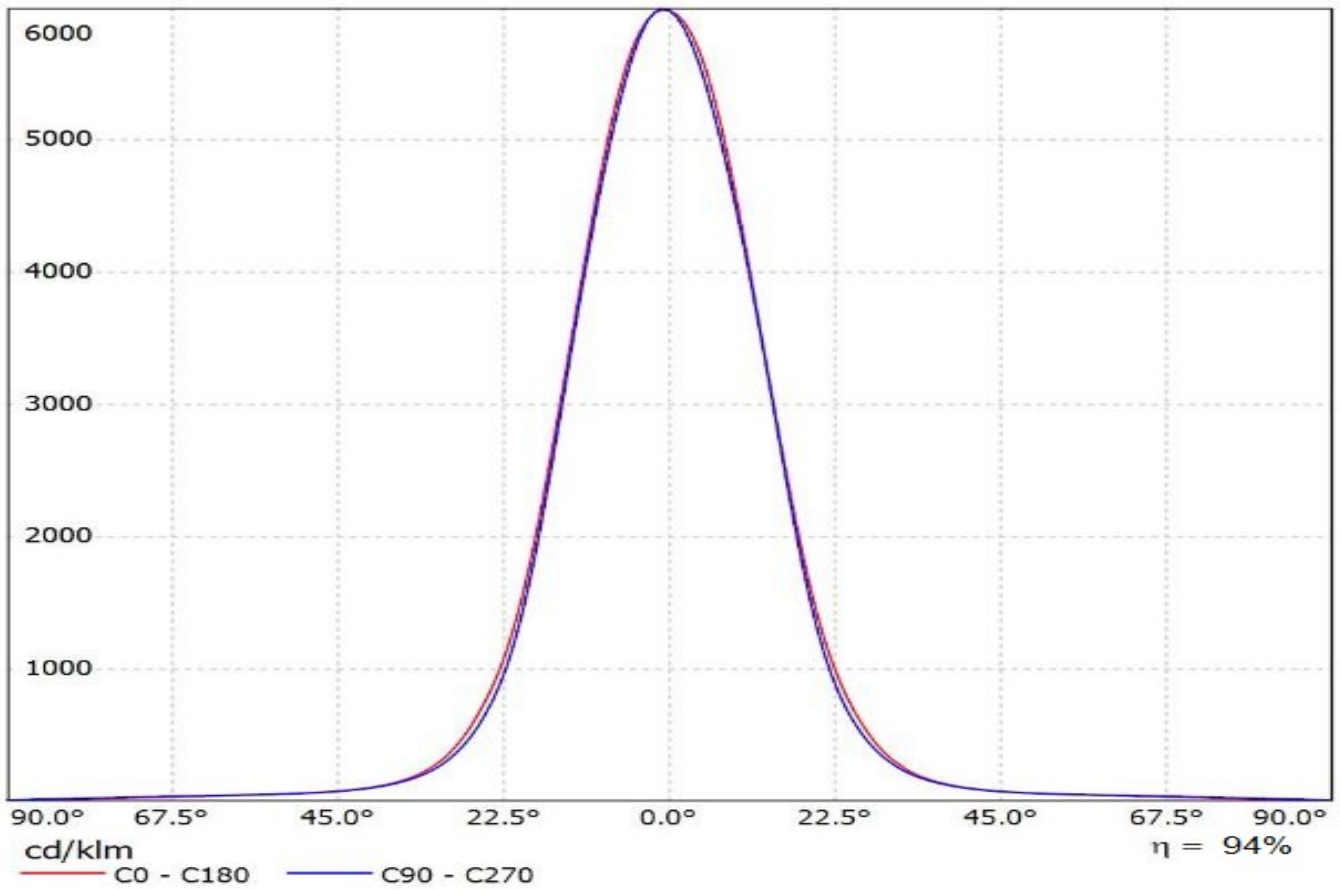

Luminaire: Ledil Oy C13233\_HB-2x2-M (Cree XT-E 390lm @ 250mA) Efficiency=92%  
Lamps: 1 x Cree XT-E 390lm @ 250mA

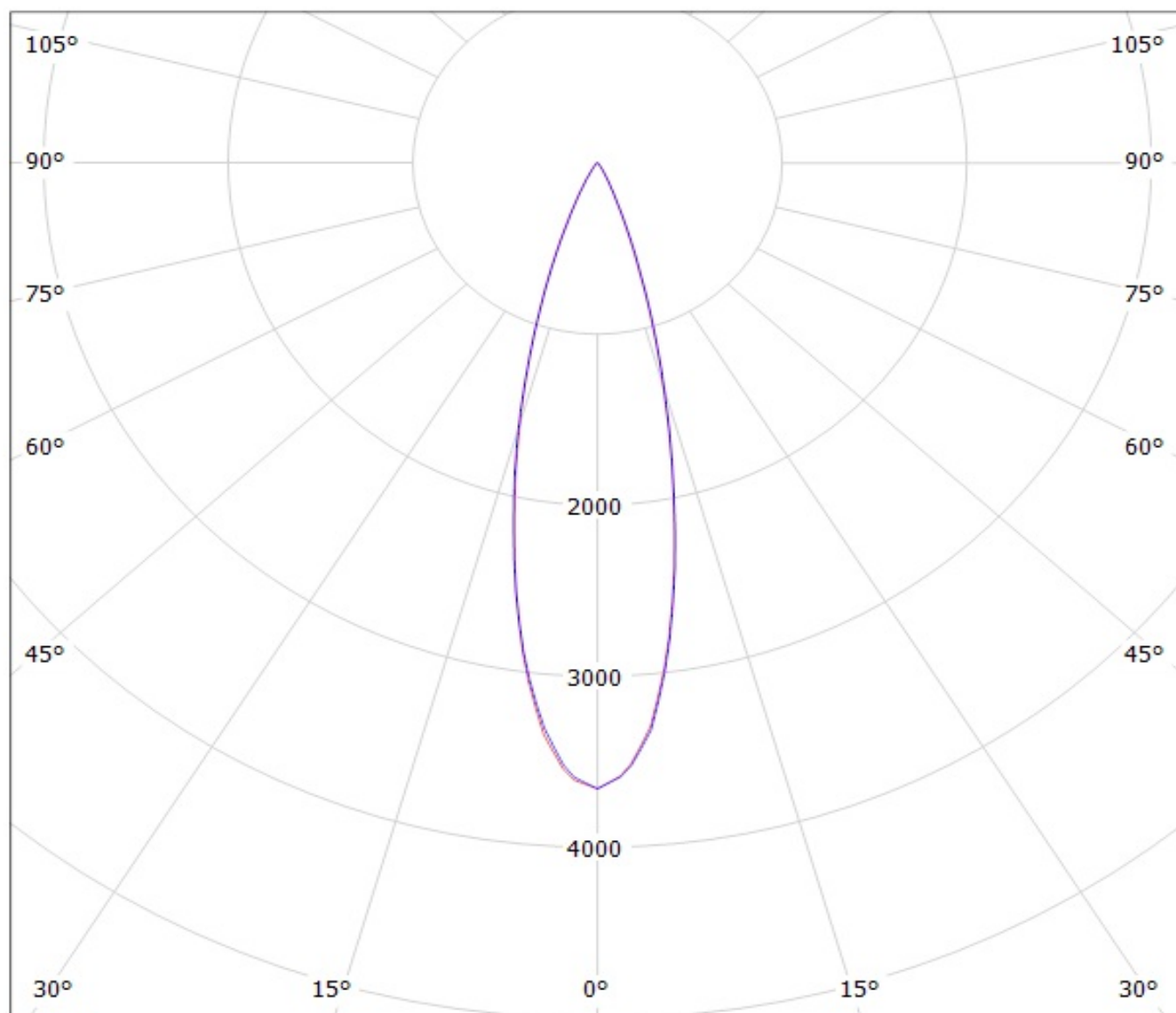

cd/klm

— C0 - C180

— C90 - C270

Luminaire: Ledil Oy C13233\_HB-2x2-M (Cree XP-G 257lm @ 250mA) Efficiency=91%  
Lamps: 1 x Cree XP-G 257lm @ 250mA

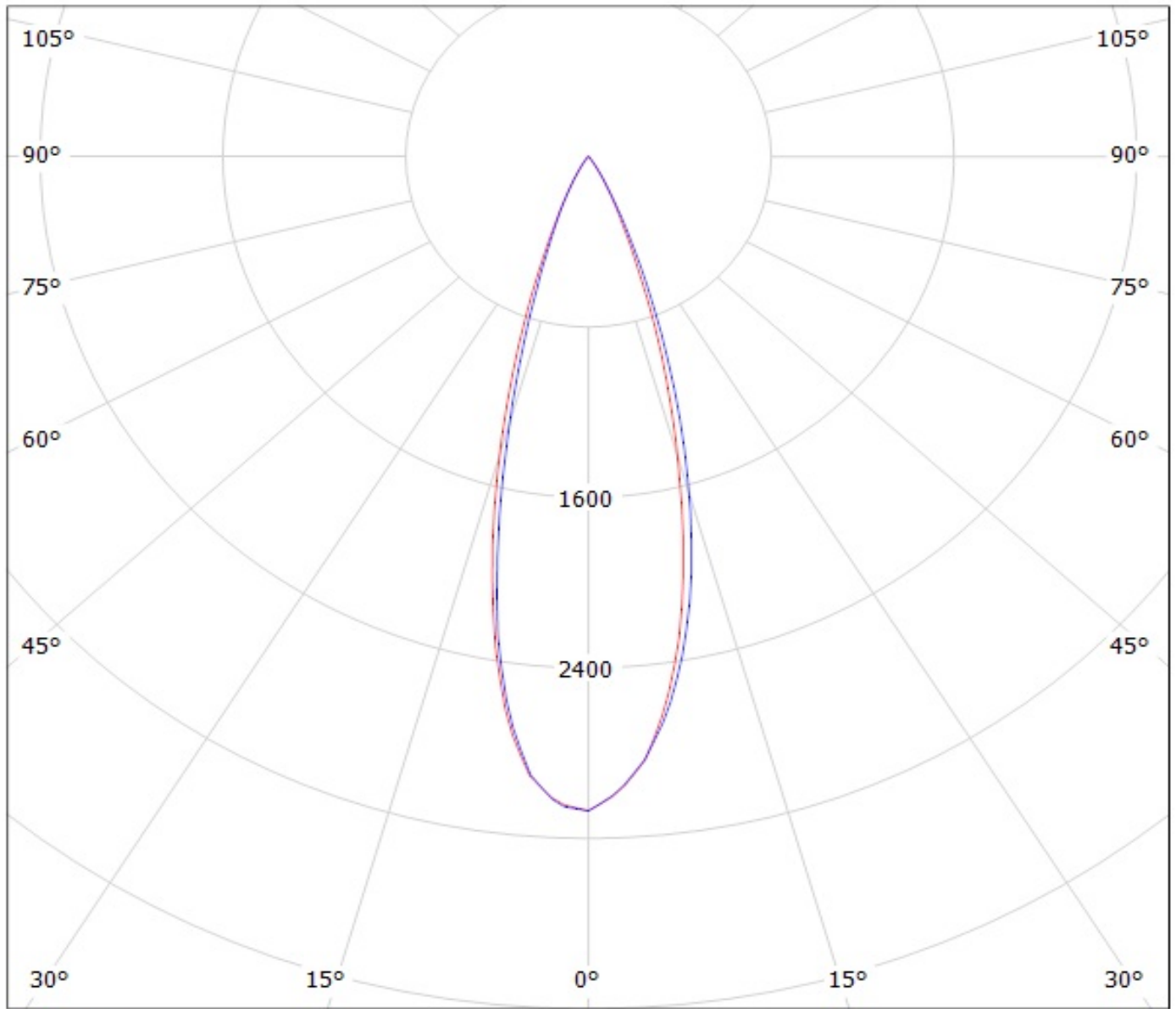

cd/klm

— C0 - C180

— C90 - C270

Luminaire: Ledil Oy C13233\_HB-2x2-M (Cree XP-G2 420lm @ 250mA) Efficiency=93%  
Lamps: 1 x Cree XP-G2 420lm @ 250mA

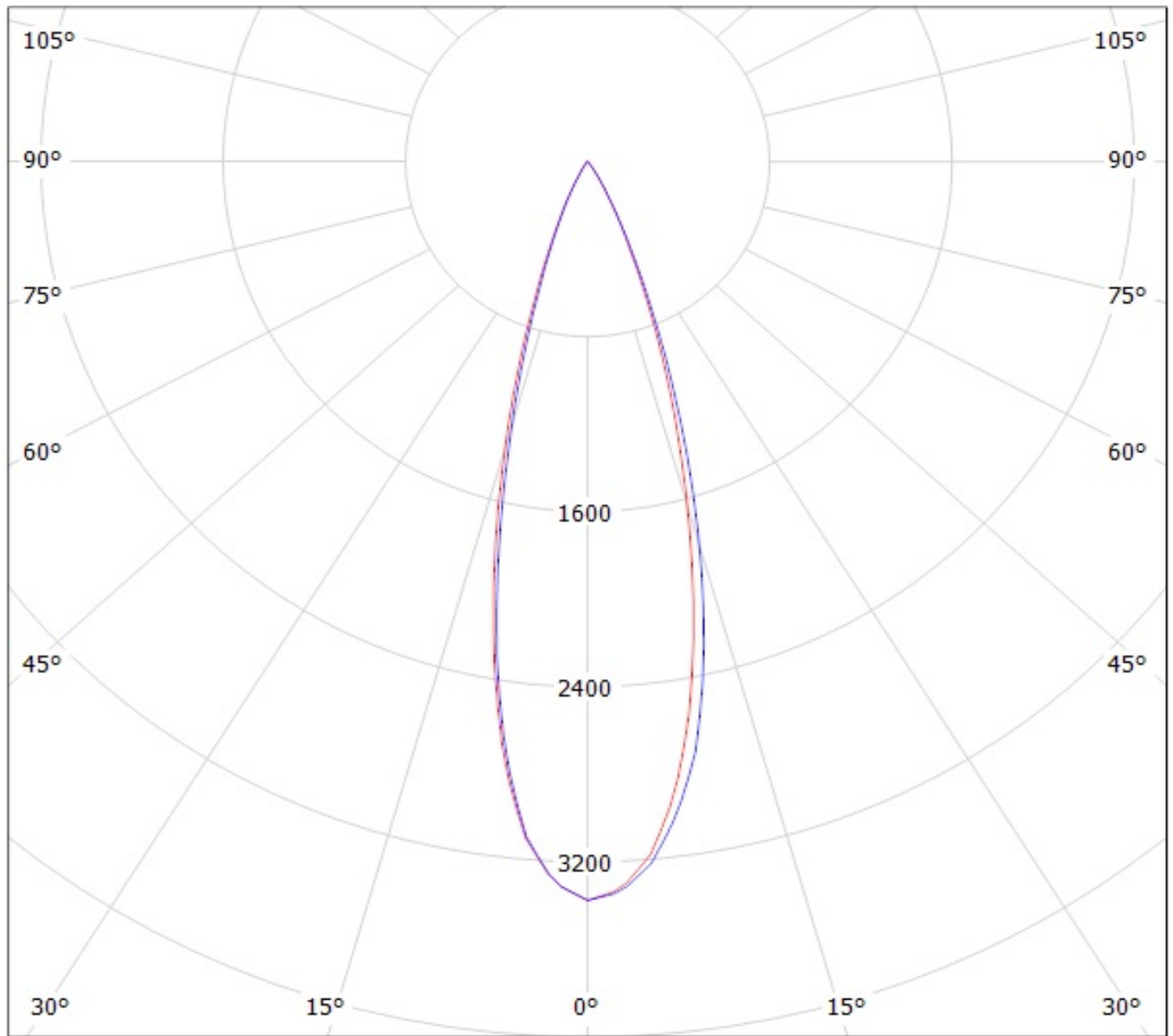

cd/klm

— C0 - C180    — C90 - C270

Luminaire: Ledil Oy C13239\_HB-2X2-M-BLIND\_(3535\_Ceramic\_gen2) Efficiency=91%  
Lamps: 1 x LG 3535 Ceramic gen2 (PKG5700K) 461lm @ 250mA CCT=6600K P=2.9W I=250mA

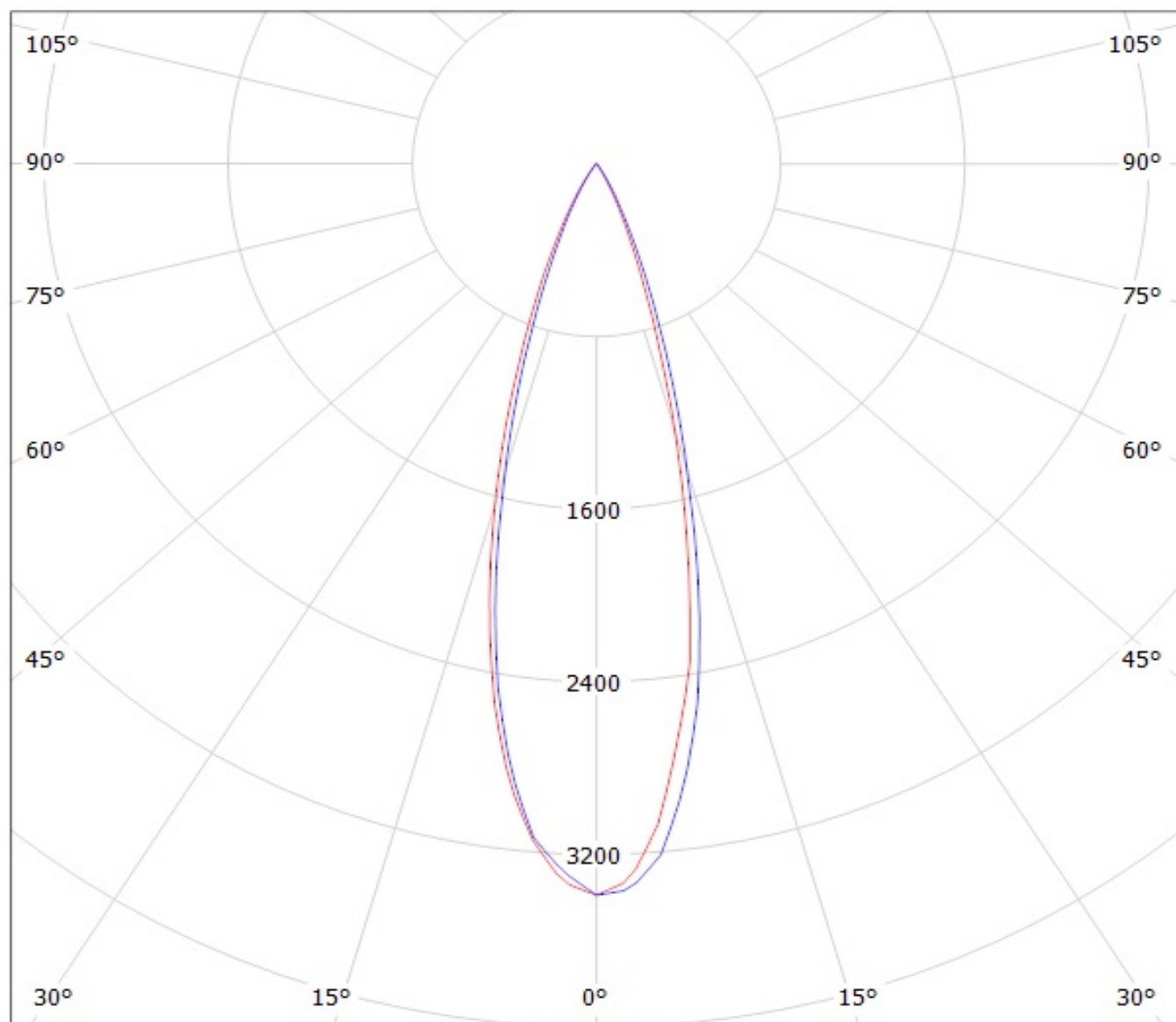

cd/klm

— C0 - C180    — C90 - C270

Luminaire: Ledil Oy C13239\_HB-2X2-M-BLIND\_(Luxeon\_Z\_ES) Efficiency=91%  
Lamps: 1 x Luxeon Z ES (LXZ2-3090) 209lm @ 250mA CCT=3000K P=2.8W I=250mA

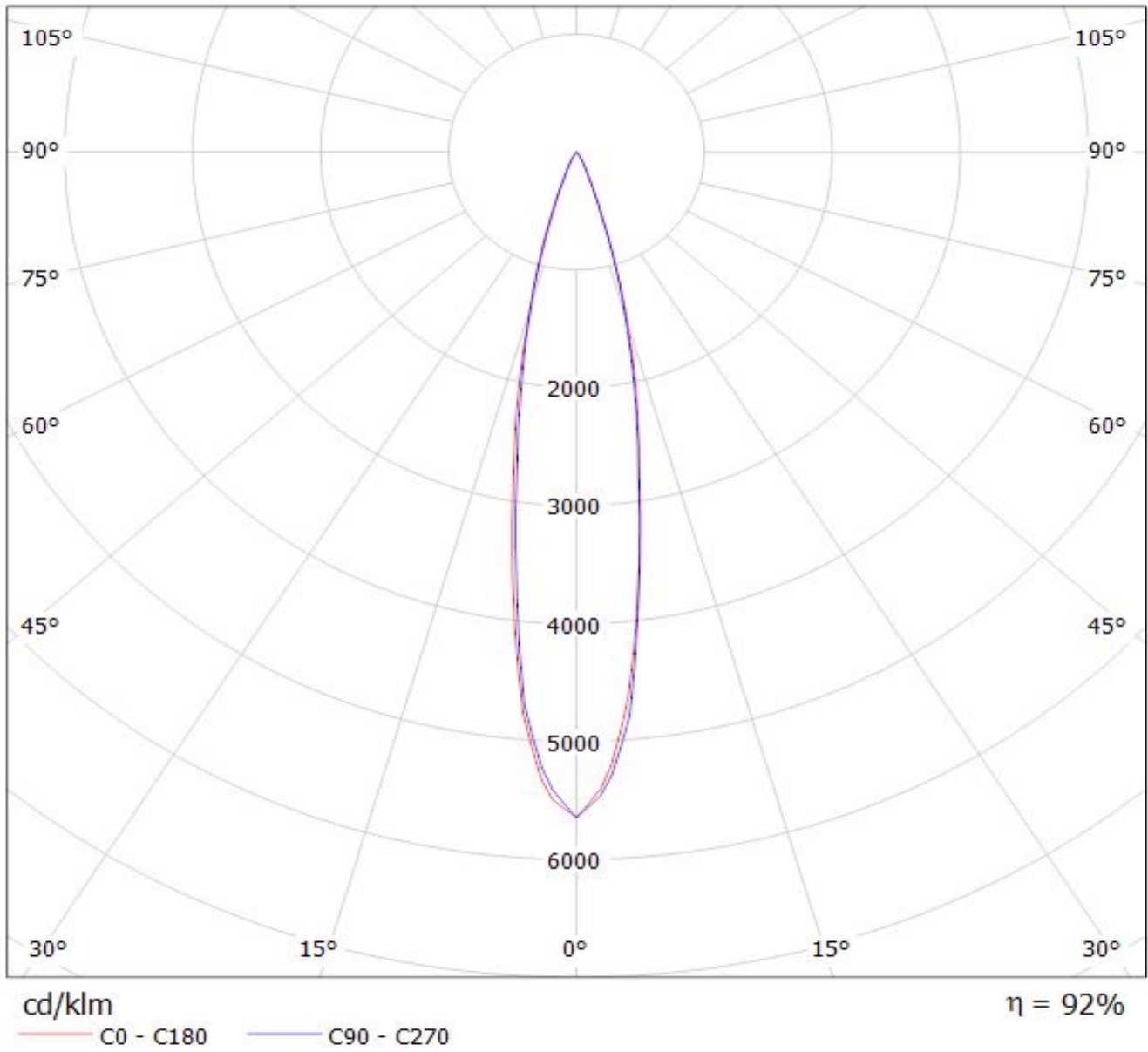

Luminaire: LEDiL Oy C13239\_HB-2X2-M-BLIND\_(LUXEON\_Q) Eff: 94%

Lamps: 1 x LUXEON\_Q\_2x2\_(LHQ-3080)\_298.363lm@250mA\_P=2.87385W\_I=249.9mA

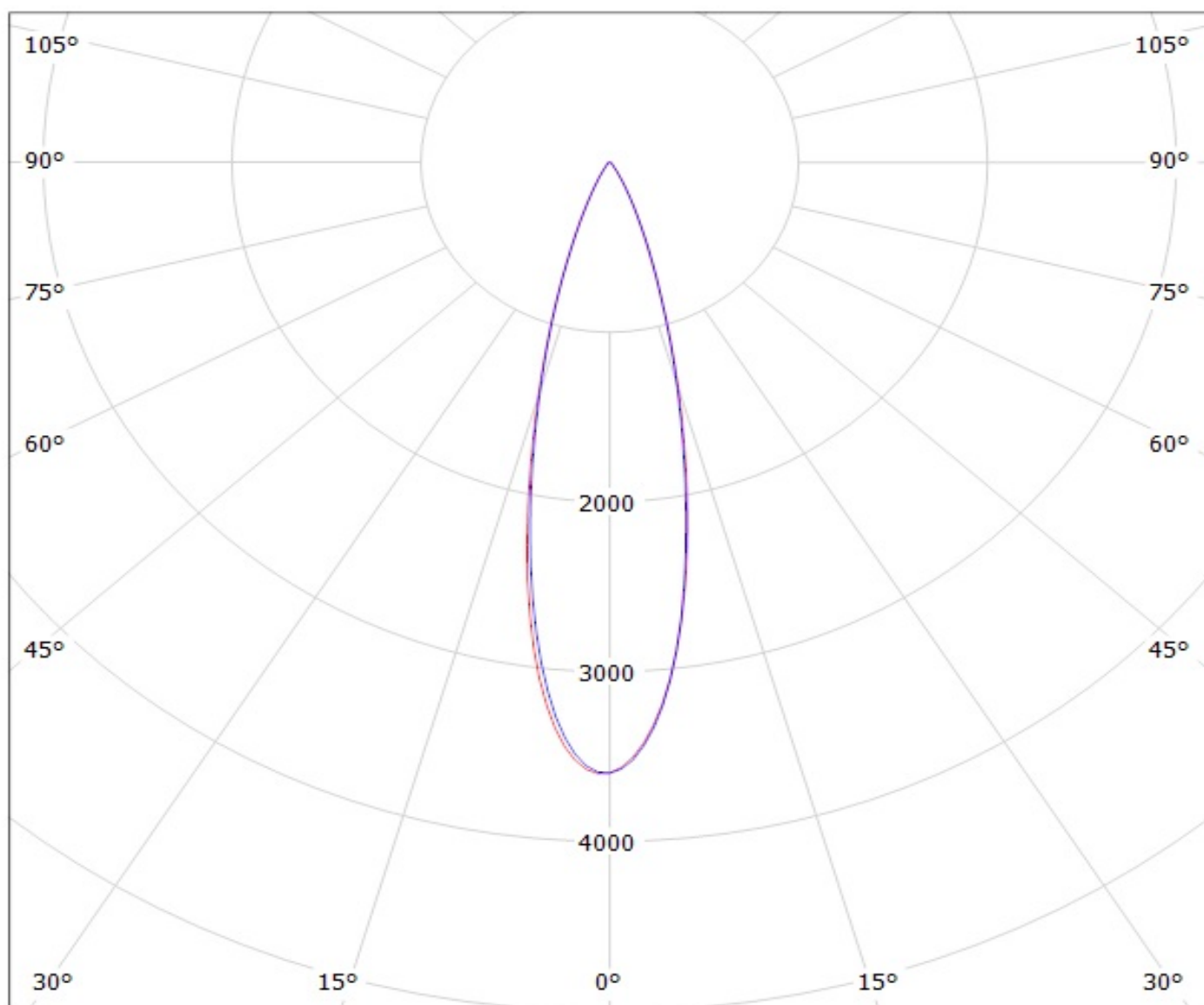

cd/klm

— C0 - C180

— C90 - C270

Luminaire: Ledil Oy C13233\_HB-2x2-M (Nichia 219B 306lm @ 250mA) Efficiency=91%  
Lamps: 1 x Nichia 219B 306lm @ 250mA

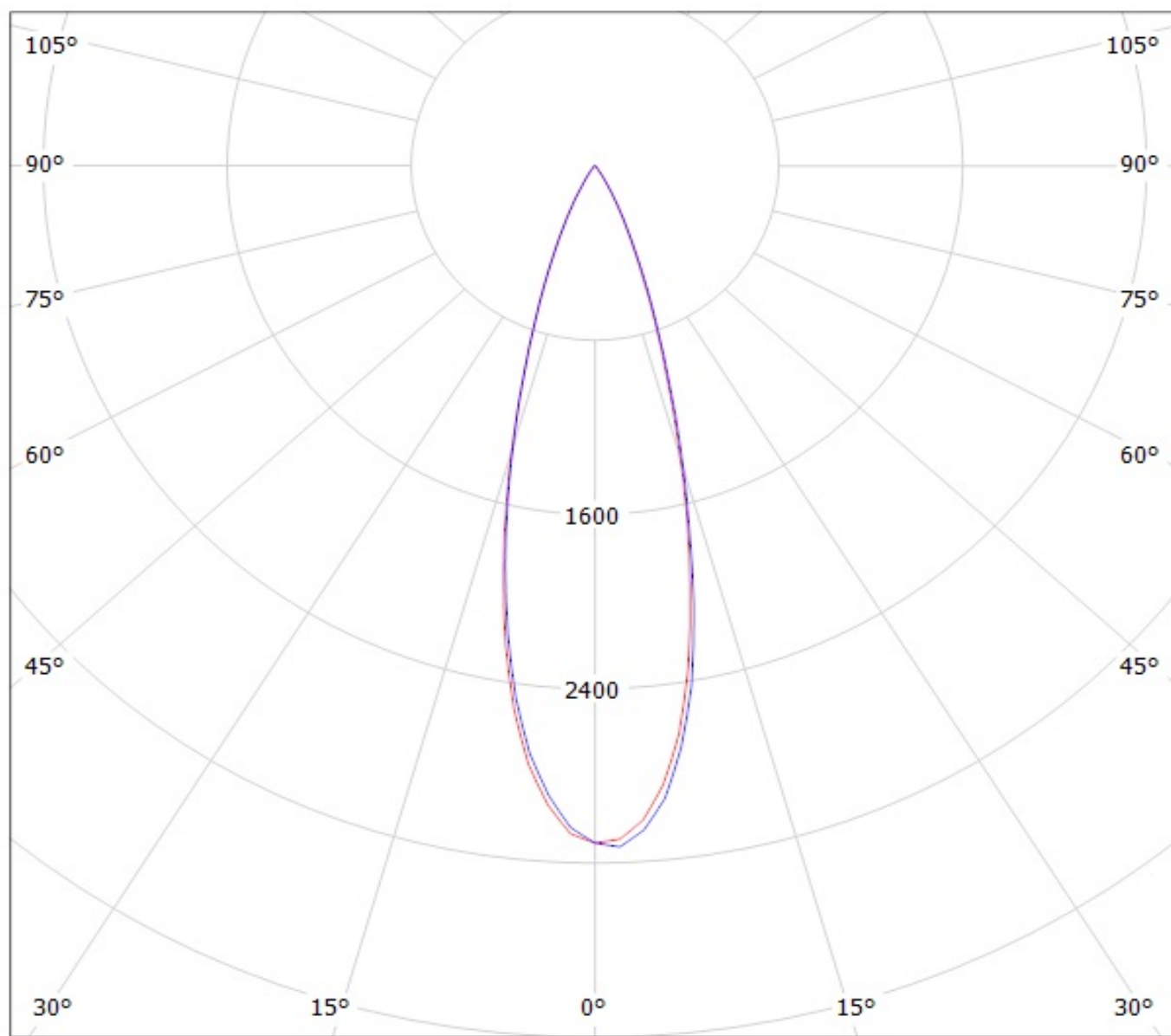

cd/klm

— C0 - C180

— C90 - C270



Luminaire: Ledil Oy C13239&C13233\_HB-2x2-M-SQPC (Osram Square PC 398lm @ 250mA) Efficiency=91%  
Lamps: 1 x Osram Square PC 398lm @ 250mA

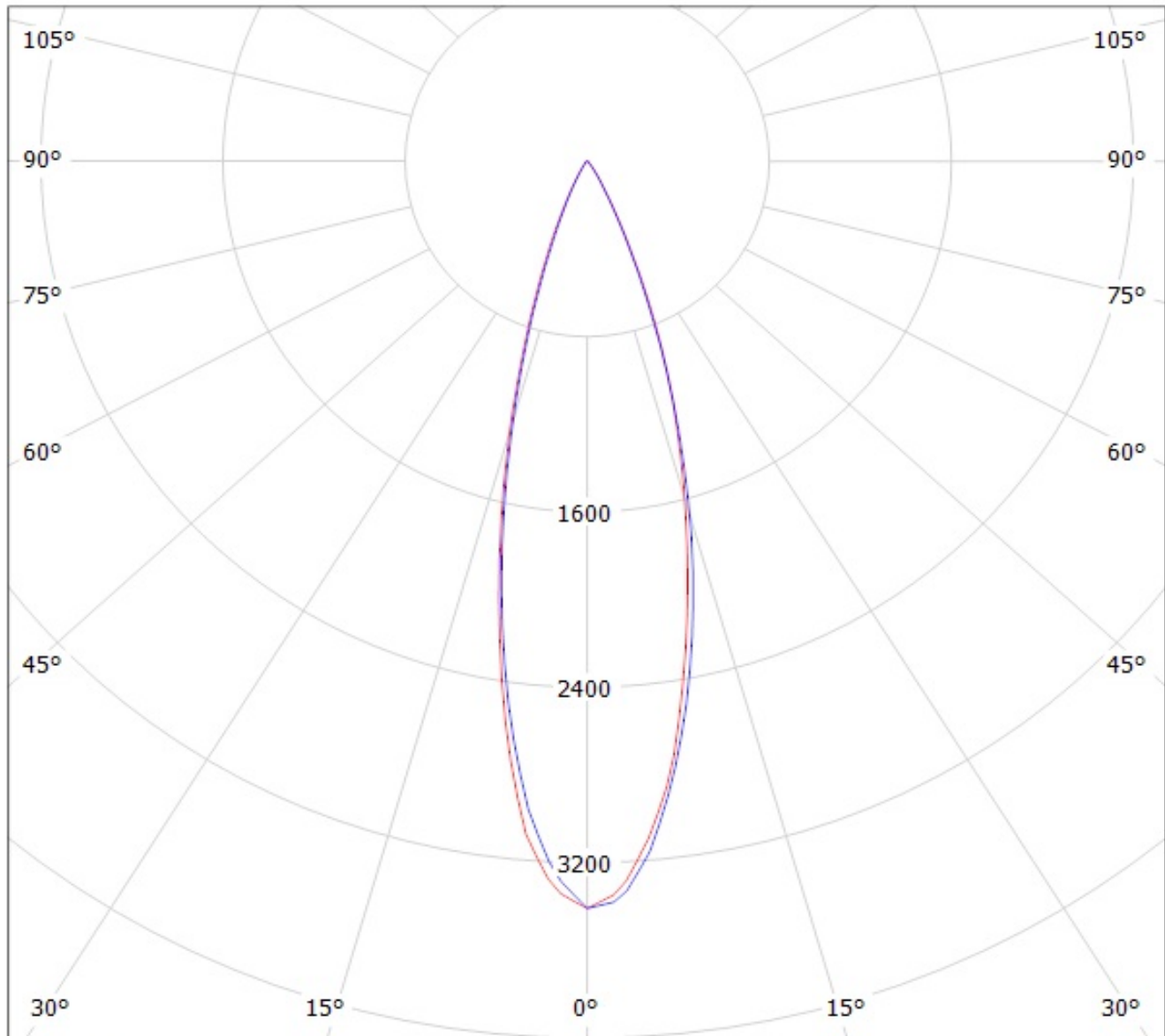

cd/klm

— C0 - C180

— C90 - C270

Luminaire: LEDiL Oy C13239\_HB-2X2-M-BLIND\_(LH351Z) Eff: 93%  
Lamps: 1 x SAMSUNG\_LH351Z\_2x2\_359.49lm@250mA\_P=2.86371W\_I=249.8mA

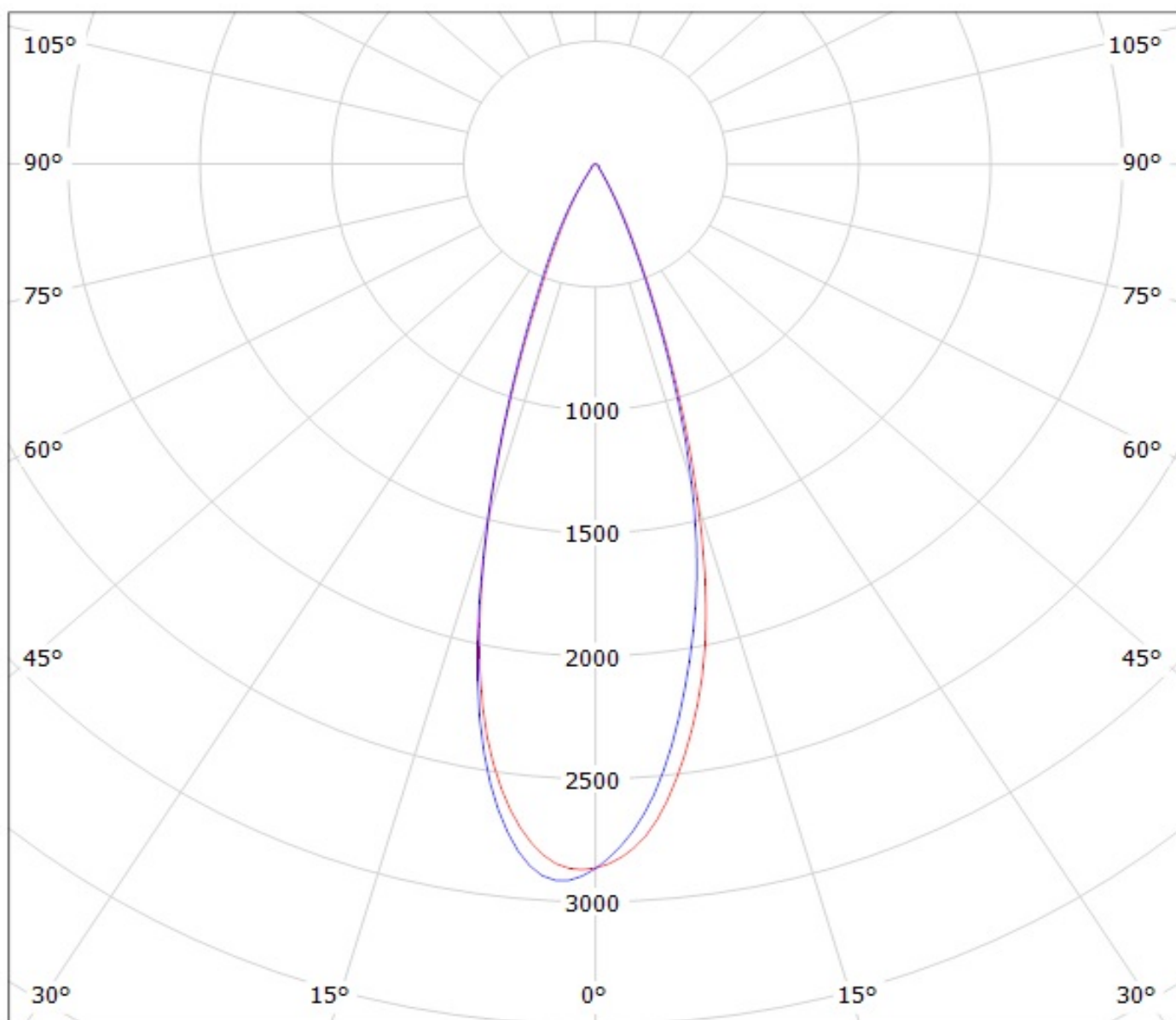

cd/klm

— C0 - C180

— C90 - C270

Luminaire: LEDil Oy C13239\_HB-2X2-M-BLIND\_(Z5M1) Efficiency=90%  
Lamps: 1 x Seoul Z5M1 (SZ5-M1-WN-C8) 379lm @ 250mA CCT=4600K P=2.9W I=250mA

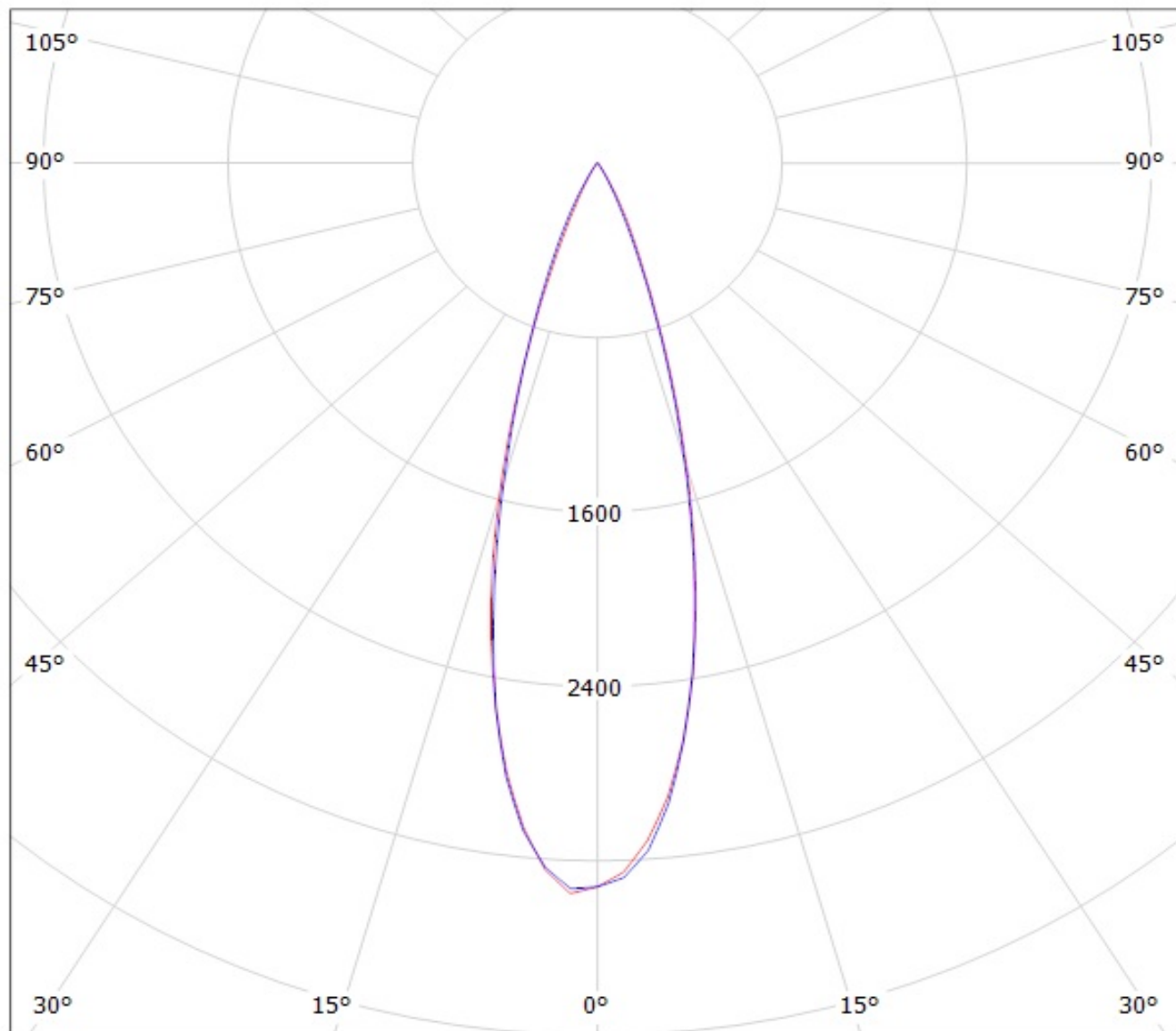

cd/klm

— C0 - C180

— C90 - C270

# Ledil C13239\_HB-2X2-M-BLIND\_(TL1L4) / LDC (Polar)

Luminaire: Ledil C13239\_HB-2X2-M-BLIND\_(TL1L4)

Lamps: 1 x Toshiba\_TL1L4\_2x2\_(TL1L4-DW0)\_472.639lm@250mA\_CCT=6500K\_P=2.9W\_I=0.25A

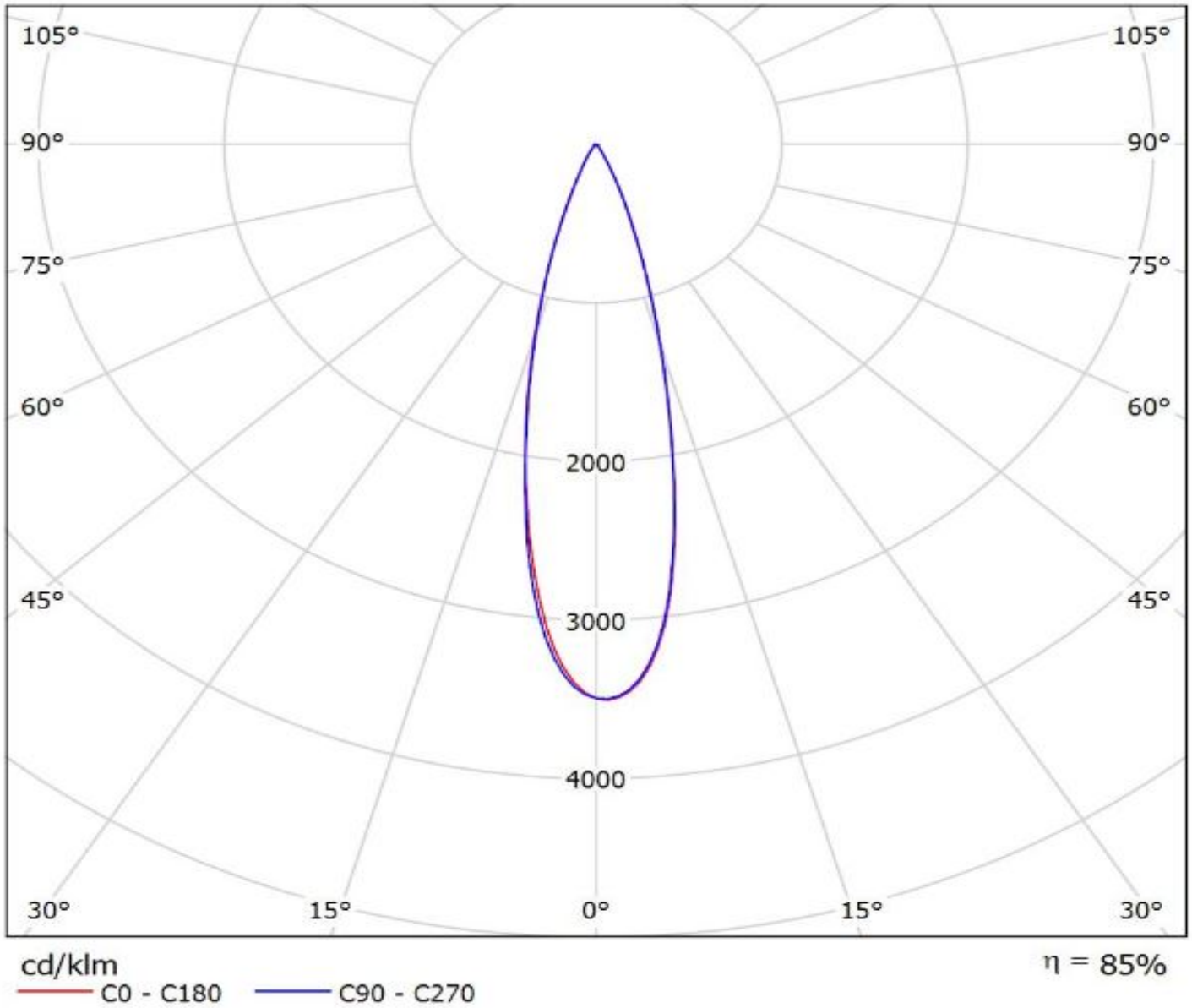

Luminaire: LEDiL Oy C13239\_HB-2X2-M-BLIND\_(Tridonic\_Module\_RLE\_G1)  
Lamps: 1 x Tridonic\_Module\_RLE\_G1\_4576.03lm@700mA\_P=32.0681W\_I=0.700A

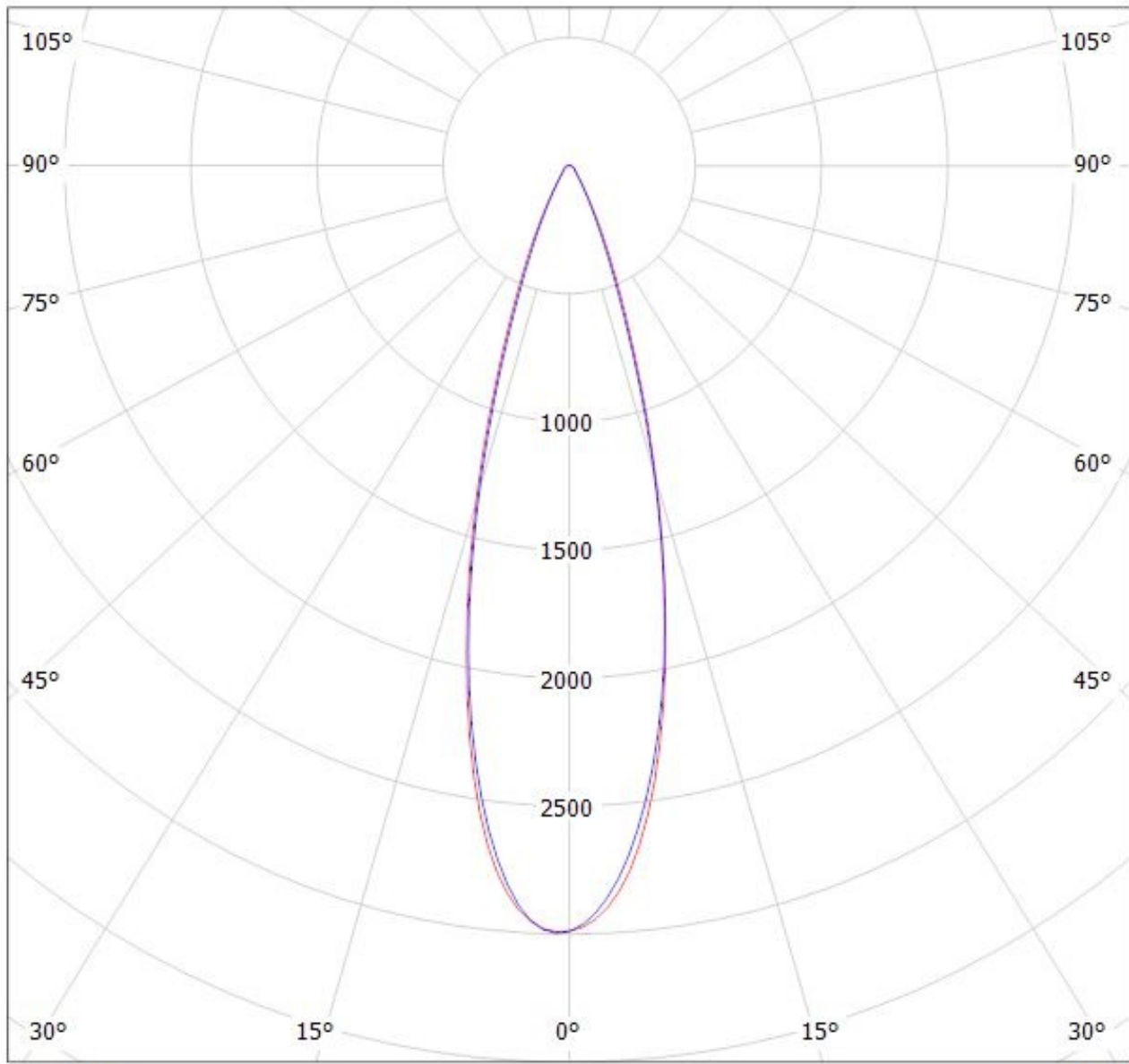

cd/klm

— C0 - C180 — C90 - C270

$\eta = 94\%$

Luminaire: LEDiL Oy C13239\_HB-2X2-M-BLIND\_(Tridonic\_Module\_RLE\_G1)  
Lamps: 1 x Tridonic\_Module\_RLE\_G1\_4576.03lm@700mA\_P=32.0681W\_I=0.700A

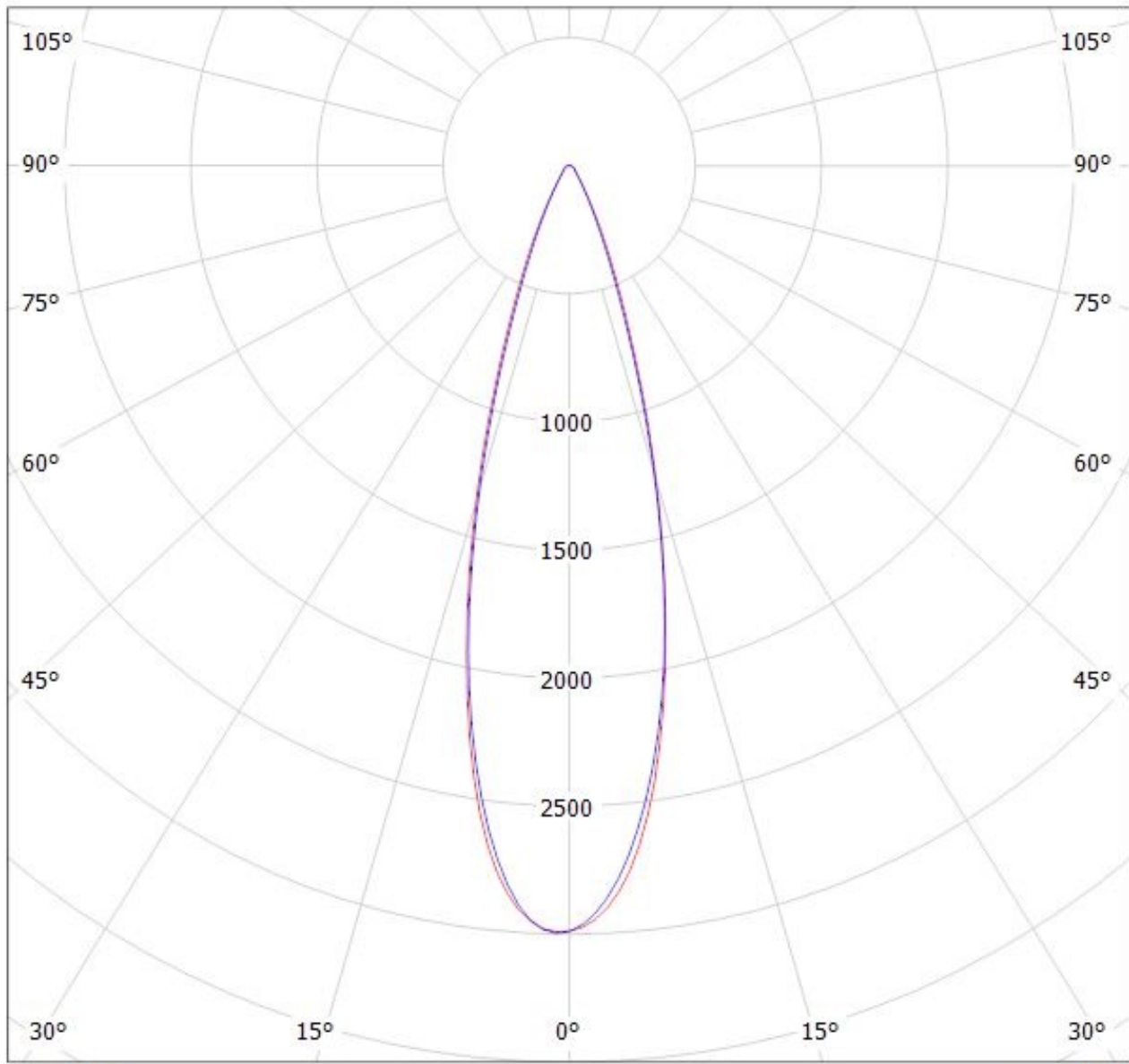

cd/klm

— C0 - C180    — C90 - C270

$\eta = 94\%$

Luminaire: LEDiL Oy C13239\_HB-2X2-M-BLIND\_(Tridonic\_Module\_RLE\_G1)  
Lamps: 1 x Tridonic\_Module\_RLE\_G1\_2288lm@700mA\_P=16W\_I=0.700A

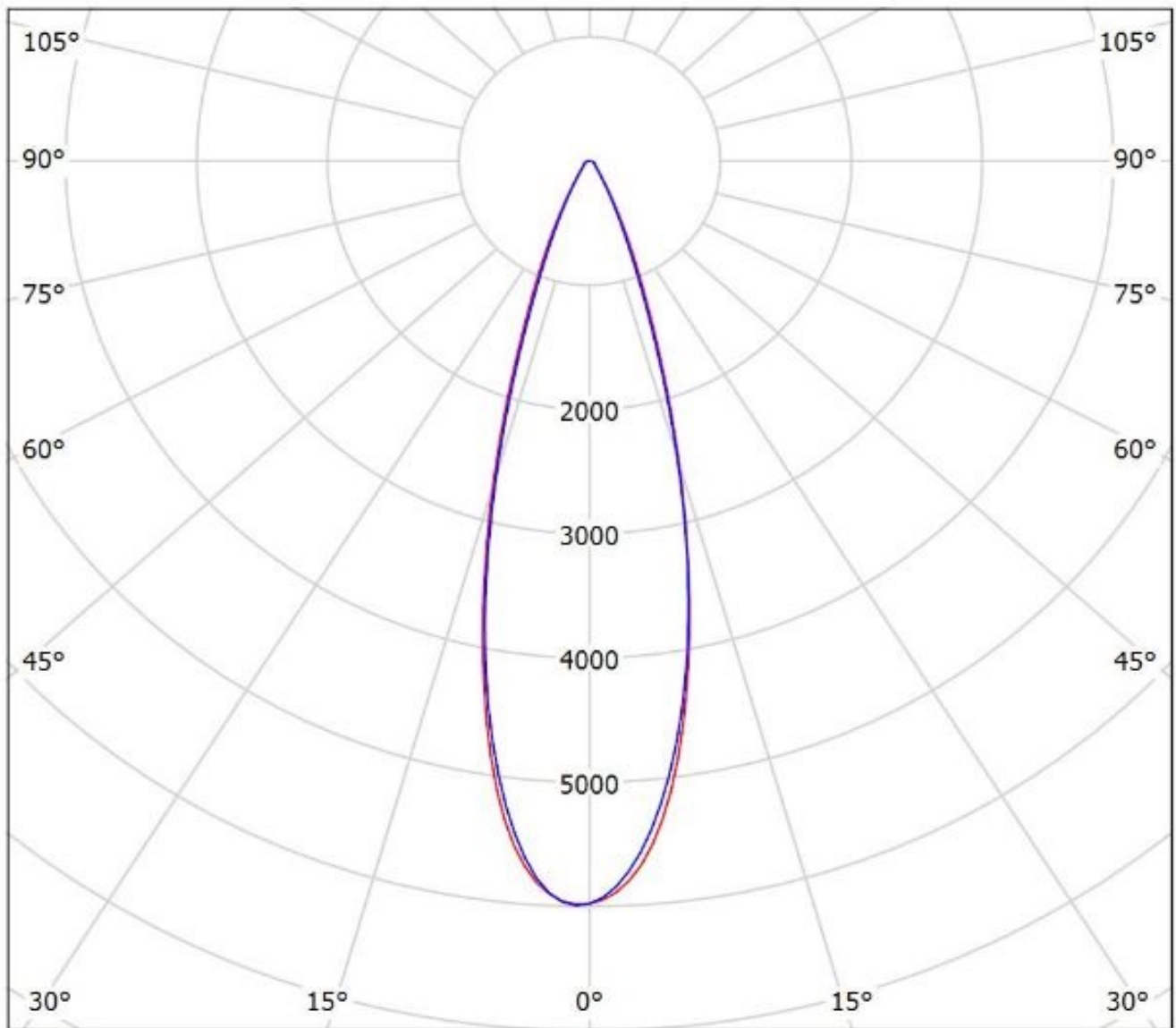

cd/klm  
— C0 - C180 — C90 - C270

$\eta = 94\%$

Luminaire: LEDiL Oy C13239\_HB-2X2-M-BLIND\_(Tridonic\_Module\_RLE\_G1)  
Lamps: 1 x Tridonic\_Module\_RLE\_G1\_2288lm@700mA\_P=16W\_I=0.700A

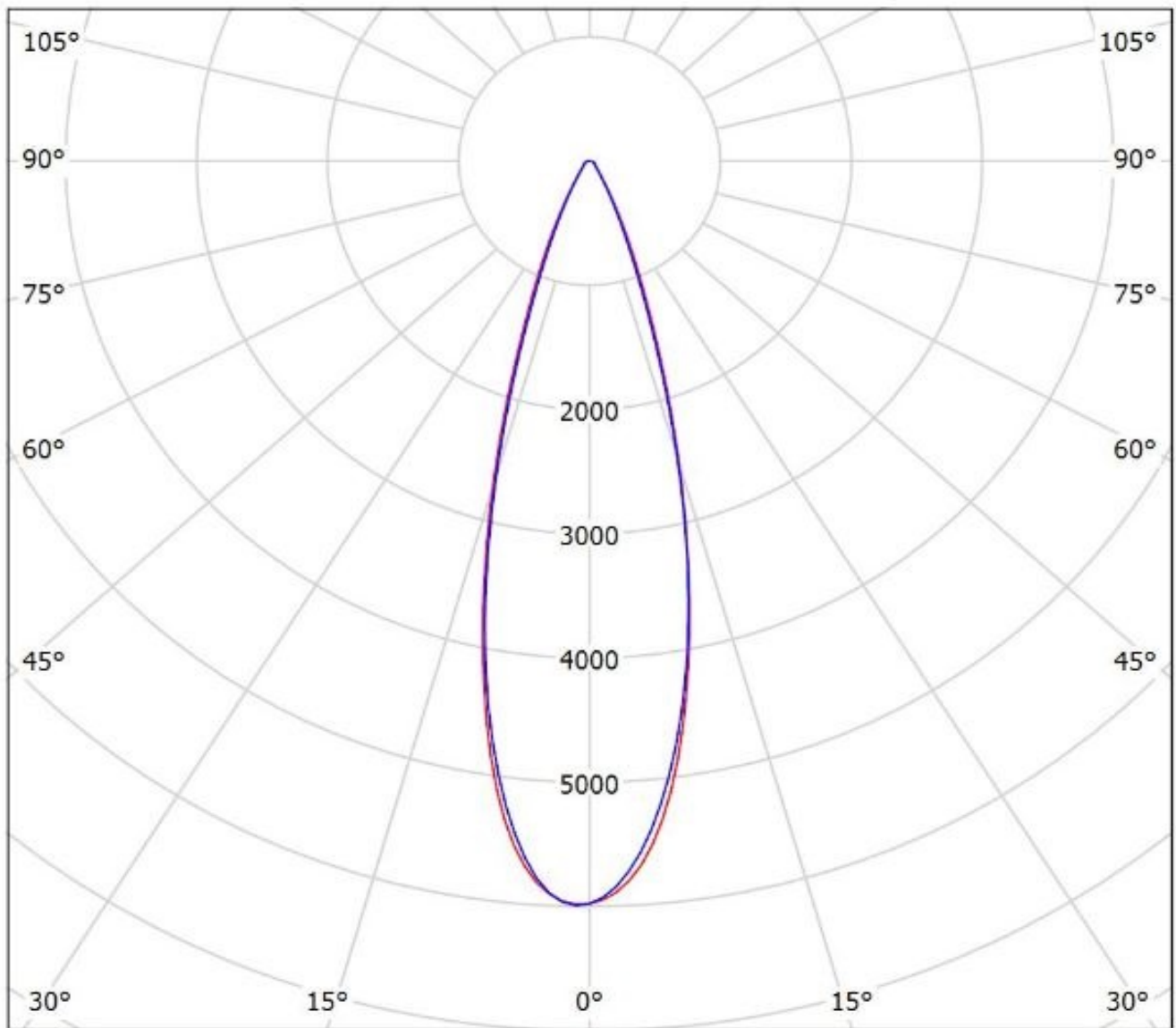

cd/klm  
— C0 - C180 — C90 - C270

$\eta = 94\%$



**NOTE: The typical divergence will be changed by different color, chip size and chip position tolerance. The typical total divergence is the full angle measured where the luminous intensity is half of the peak value.**