

PART NUMBER CODING

E _ M _ _ D W W _

NUMBER OF POSITIONS

MOUNTING STYLE

- H = .125" DIA. CLEARANCE HOLES
- I = #4-40 THREADED INSERT (PAGE 2)
- N = NO MOUNTING EARS (PAGE 2)

PLATING

ALL PLATING ARE LEAD FREE AND HAVE .000050" NICKEL UNDERPLATE

- | | CONTACT SURFACE | TERMINATION |
|-----|---|--------------------------|
| Y = | .000030" GOLD | .000005" GOLD |
| B = | .000010" GOLD | .000100" PURE TIN, MATTE |
| C = | .000030" GOLD | .000100" PURE TIN, MATTE |
| E = | .000100" PURE TIN, MATTE OVERALL | |
| G = | .000010" GOLD | .000005" GOLD |
| S = | .000010" GOLD OVERALL | |
| M = | .000030" GOLD ON CONTACT SURFACE, .000010" GOLD OVERALL | |

REVISIONS				
REV.	ECO. NO	DESCRIPTION	DATE	BY
A	725	INITIAL RELEASE	9/2/2005	TT

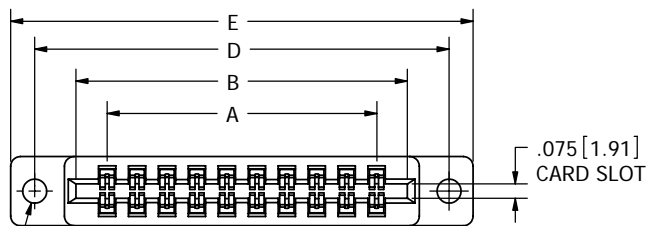
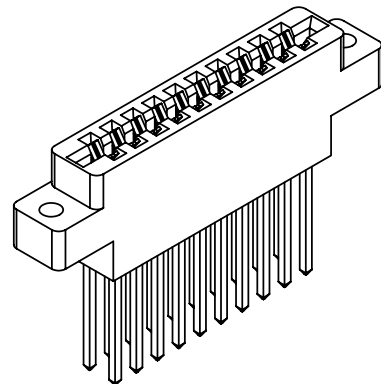

2X Ø.125 [3.18]

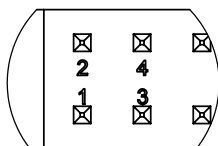

CONTACT MARKINGS
SCALE 4 : 1

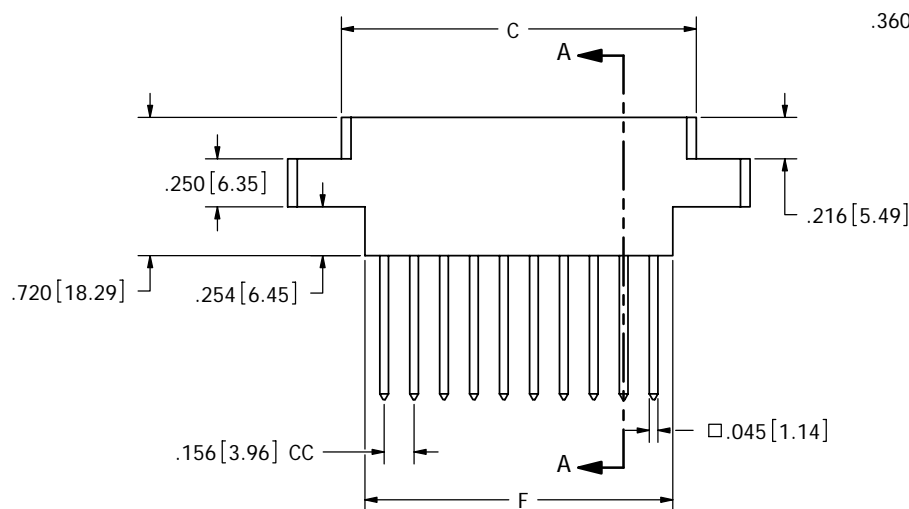

E _ M _ _ D W W H

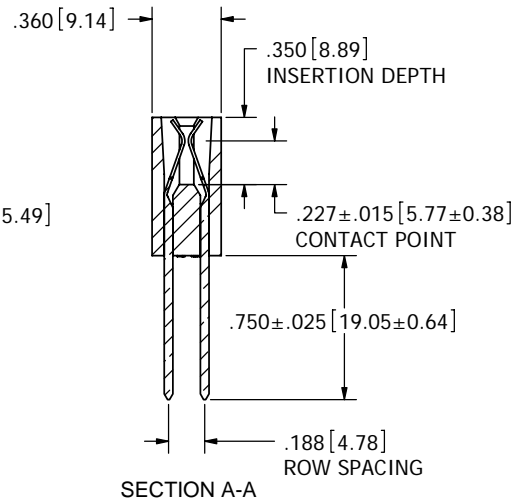

NOTES:

1. INSULATOR MATERIAL: PBT
2. CONTACT MATERIAL: PHOSPHOR BRONZE
3. PLATING: SEE PART NUMBER CODING
4. OPERATING TEMPERATURE: -65°C TO +125°C
5. PROCESSING TEMP: 260°C FOR 10 SECONDS MAX
6. UL FLAMMABILITY RATING: 94V-0
7. VOLTAGE RATING: 1800 VDC MINIMUM AT SEA LEVEL.
8. CURRENT RATING: 3 AMP PER CONTACT PAIR
9. VOLTAGE DROP: 30 MILLI VOLT AT RATED CURRENT
10. INSULATION RESISTANCE: 5000 MEGA OHM
11. CONNECTOR IDENTIFICATION: THE PART SHALL BE MARKED WITH A PART NUMBER AND BARCODE
12. BOARD THICKNESS ACCOMMODATED: .062 ± .008"
13. BOARD INSERTION FORCE: 16 OZ MAX PER CONTACT PAIR WHEN USING A .062" TEST BLADE.
INTERNAL INSPECTION TO BE PER SULLIN'S WORK INSTRUCTION W17.3-01.
14. BOARD WITHDRAWAL FORCE: 1 OUNCE MINIMUM PER CONTACT PAIR USING .062" PCB



RoHS COMPLIANT

CUSTOMER COPY

UNLESS OTHERWISE SPECIFIED: DIMENSIONS ARE IN INCHES[MM]		DATE	NAME
TOLERANCES: ANGULAR: ± 1° XX = ± .02 [.508] .XXX = ± .005 [.1270] .XXXX = ± .0005 [.0127] PARENTHEICAL INFORMATION IS FOR REFERENCE ONLY		9/2/2005	TT
THE INFORMATION HEREIN CONTAINS PROPRIETARY INFORMATION OF SULLINS ELECTRONICS AND IS NOT TO BE REPRODUCED, USED OR DISCLOSED TO OTHERS FOR ANY PURPOSE EXCEPT AS SPECIFICALLY AUTHORIZED IN WRITING BY AN OFFICER OF SULLINS ELECTRONICS.		DESCRIPTION	
INTERPRET DIMENSIONS AND GEOMETRIC TOLERANCING PER: ANSI Y14.5-1984		SULLINS ELECTRONICS	
SIZE DWG. NO		EDGE CARD CONNECTOR	
TOLERANCING		PART NUMBER	
PER: ANSI Y14.5-1984		E _ M _ _ D W W _	
SCALE: 2:1		REV	A
SHEET 1 OF 2		C10555	

PART NO.	NO. OF POS	A ± .008[0.20]		B ± .008[0.20]		C ± .015[0.38]		D ± .010[0.25]		E ± .020[0.51]		F ± .015[0.38]	
		IN	MM	IN	MM	IN	MM	IN	MM	IN	MM	IN	MM
E_M06DWW_*	6	0.780	19.81	1.100	27.94	1.224	31.09	1.534	38.96	1.784	45.314	0.980	24.89
E_M10DWW_	10	1.404	35.66	1.724	43.79	1.848	46.94	2.158	54.81	2.408	61.163	1.604	40.74
E_M12DWW_	12	1.716	43.59	2.036	51.71	2.160	54.86	2.470	62.74	2.720	69.088	1.916	48.67
E_M15DWW_	15	2.184	55.47	2.504	63.60	2.628	66.75	2.938	74.63	3.188	80.975	2.384	60.55
E_M18DWW_	18	2.652	67.36	2.972	75.49	3.096	78.64	3.406	86.51	3.656	92.862	2.852	72.44
E_M22DWW_	22	3.276	83.21	3.596	91.34	3.720	94.49	4.030	102.36	4.280	108.712	3.476	88.29
E_M25DWW_*	25	3.744	95.10	4.064	103.23	4.188	106.38	4.498	114.25	4.748	120.599	3.944	100.18
E_M28DWW_	28	4.212	106.98	4.532	115.11	4.656	118.26	4.966	126.14	5.216	132.486	4.412	112.06
E_M30DWW_*	30	4.524	114.91	4.844	123.04	4.968	126.19	5.278	134.06	5.528	140.411	4.724	119.99
E_M31DWW_*	31	4.680	118.87	5.000	127.00	5.124	130.15	5.434	138.02	5.684	144.374	4.880	123.95
E_M36DWW_	36	5.460	138.68	5.780	146.81	5.904	149.96	6.214	157.84	6.464	164.186	5.660	143.76
E_M43DWW_*	43	6.552	166.42	6.872	174.55	6.996	177.70	7.306	185.57	7.556	191.922	6.752	171.50
E_M50DWW_*	50	7.644	194.16	7.964	202.29	8.088	205.44	8.398	213.31	8.648	219.659	7.844	199.24

* INDICATES NO TOOLING FOR THAT PART

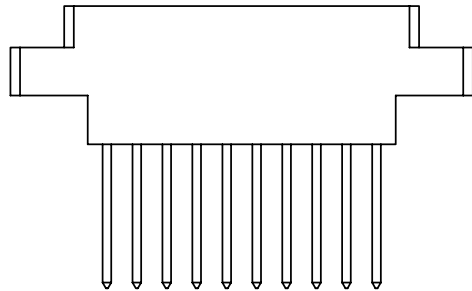
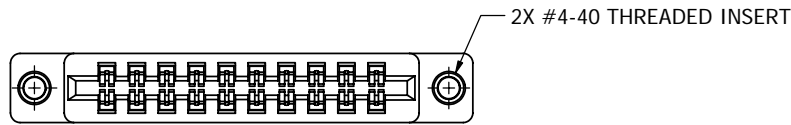

E_M__DWWI

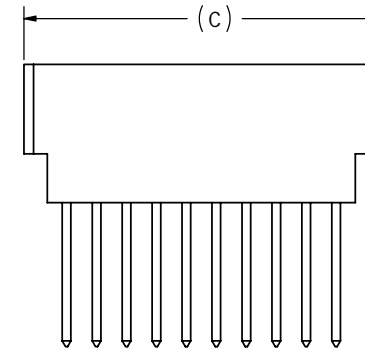

E_M__DWWN

CUSTOMER COPY



RoHS COMPLIANT

UNLESS OTHERWISE SPECIFIED:
 DIMENSIONS ARE IN INCHES[MM]
 TOLERANCES:
 ANGULAR: ± 1°
 XX = ± .02 [.508]
 .XXX = ± .005 [.1270]
 .XXXX = ± .0005 [.0127]
 PARENTHESES INFORMATION IS FOR REFERENCE ONLY

INTERPRET DIMENSIONS AND GEOMETRIC TOLERANCING PER: ANSI Y14.5-1984

DRAWN	DATE	NAME
TT	9/2/2005	TT

THE INFORMATION HEREIN CONTAINS PROPRIETARY INFORMATION OF SULLINS ELECTRONICS AND IS NOT TO BE REPRODUCED, USED OR DISCLOSED TO OTHERS FOR ANY PURPOSE EXCEPT AS SPECIFICALLY AUTHORIZED IN WRITING BY AN OFFICER OF SULLINS ELECTRONICS.

SULLINS ELECTRONICS	
DESCRIPTION EDGECARD CONNECTOR	
PART NUMBER E_M__DWW_	
SIZE C	DWG. NO. C10555
REV A	SCALE: 2:1