

Standard Rectifier Module

| | |
|-------------------------|--------|
| 3~ Rectifier | |
| V_{RRM} | = 1800 |
| I_{DAV} | = 30 |
| I_{FSM} | = 150 |

3~ Rectifier Bridge

Part number

VUO22-18NO1

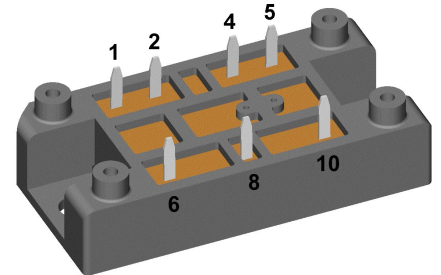

Backside: isolated

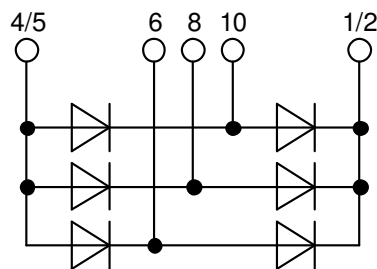
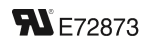

Features / Advantages:

- Package with DCB ceramic
- Improved temperature and power cycling
- Planar passivated chips
- Very low forward voltage drop
- Very low leakage current

Applications:

- Diode for main rectification
- For three phase bridge configurations
- Supplies for DC power equipment
- Input rectifiers for PWM inverter
- Battery DC power supplies
- Field supply for DC motors

Package: V1-A-Pack

- Isolation Voltage: 3600 V~
- Industry standard outline
- RoHS compliant
- Soldering pins for PCB mounting
- Height: 17 mm
- Base plate: DCB ceramic
- Reduced weight
- Advanced power cycling

Terms Conditions of usage:

The data contained in this product data sheet is exclusively intended for technically trained staff. The user will have to evaluate the suitability of the product for the intended application and the completeness of the product data with respect to his application. The specifications of our components may not be considered as an assurance of component characteristics. The information in the valid application- and assembly notes must be considered. Should you require product information in excess of the data given in this product data sheet or which concerns the specific application of your product, please contact the sales office, which is responsible for you.

Due to technical requirements our product may contain dangerous substances. For information on the types in question please contact the sales office, which is responsible for you.

Should you intend to use the product in aviation, in health or live endangering or life support applications, please notify. For any such application we urgently recommend

- to perform joint risk and quality assessments;

- the conclusion of quality agreements;

- to establish joint measures of an ongoing product survey, and that we may make delivery dependent on the realization of any such measures.

| Rectifier | | | | Ratings | | | |
|------------|--|-----------------------------|-------------------|-------------------------|------|-----------------------------------|------------------|
| Symbol | Definition | Conditions | | min. | typ. | max. | Unit |
| V_{RSM} | max. non-repetitive reverse blocking voltage | | | $T_{VJ} = 25^{\circ}C$ | | 1900 | V |
| V_{RRM} | max. repetitive reverse blocking voltage | | | $T_{VJ} = 25^{\circ}C$ | | 1800 | V |
| I_R | reverse current | $V_R = 1800$ V | | $T_{VJ} = 25^{\circ}C$ | | 10 | μA |
| | | $V_R = 1800$ V | | $T_{VJ} = 150^{\circ}C$ | | 0,7 | mA |
| V_F | forward voltage drop | $I_F = 10$ A | | $T_{VJ} = 25^{\circ}C$ | | 1,19 | V |
| | | $I_F = 30$ A | | | | 1,59 | V |
| | | $I_F = 10$ A | | $T_{VJ} = 125^{\circ}C$ | | 1,13 | V |
| | | $I_F = 30$ A | | | | 1,66 | V |
| I_{DAV} | bridge output current | $T_C = 110^{\circ}C$ | | $T_{VJ} = 150^{\circ}C$ | | 30 | A |
| | | rectangular | $d = \frac{1}{3}$ | | | | |
| V_{FO} | threshold voltage | | | $T_{VJ} = 150^{\circ}C$ | | 0,84 | V |
| r_F | slope resistance | | | | | 28 | m Ω |
| | | | | | | } for power loss calculation only | |
| R_{thJC} | thermal resistance junction to case | | | | | 2,5 | K/W |
| R_{thCH} | thermal resistance case to heatsink | | | | 0,4 | | K/W |
| P_{tot} | total power dissipation | | | $T_C = 25^{\circ}C$ | | 50 | W |
| I_{FSM} | max. forward surge current | $t = 10$ ms; (50 Hz), sine | | $T_{VJ} = 45^{\circ}C$ | | 150 | A |
| | | $t = 8,3$ ms; (60 Hz), sine | | $V_R = 0$ V | | 160 | A |
| | | $t = 10$ ms; (50 Hz), sine | | $T_{VJ} = 150^{\circ}C$ | | 130 | A |
| | | $t = 8,3$ ms; (60 Hz), sine | | $V_R = 0$ V | | 140 | A |
| I^2t | value for fusing | $t = 10$ ms; (50 Hz), sine | | $T_{VJ} = 45^{\circ}C$ | | 115 | A ² s |
| | | $t = 8,3$ ms; (60 Hz), sine | | $V_R = 0$ V | | 105 | A ² s |
| | | $t = 10$ ms; (50 Hz), sine | | $T_{VJ} = 150^{\circ}C$ | | 85 | A ² s |
| | | $t = 8,3$ ms; (60 Hz), sine | | $V_R = 0$ V | | 82 | A ² s |
| C_J | junction capacitance | $V_R = 400$ V; $f = 1$ MHz | | $T_{VJ} = 25^{\circ}C$ | | 4 | pF |

| Package V1-A-Pack | | | | Ratings | | | |
|-------------------|--|----------------------|------|---------|------|------|--|
| Symbol | Definition | Conditions | min. | typ. | max. | Unit | |
| I_{RMS} | RMS current | per terminal | | | 100 | A | |
| T_{VJ} | virtual junction temperature | | -40 | | 150 | °C | |
| T_{op} | operation temperature | | -40 | | 125 | °C | |
| T_{stg} | storage temperature | | -40 | | 125 | °C | |
| Weight | | | | | 37 | g | |
| M_D | mounting torque | | 2 | | 2,5 | Nm | |
| $d_{Spp/App}$ | creepage distance on surface / striking distance through air | terminal to terminal | 6,0 | | | mm | |
| $d_{Spb/Apb}$ | | terminal to backside | 12,0 | | | mm | |
| V_{ISOL} | isolation voltage | t = 1 second | 3600 | | | V | |
| | | t = 1 minute | 3000 | | | V | |

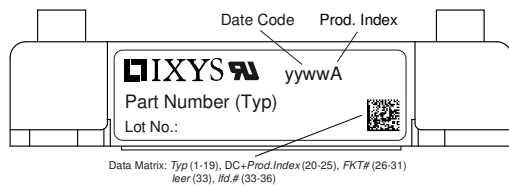

| Ordering | Ordering Number | Marking on Product | Delivery Mode | Quantity | Code No. |
|----------|-----------------|--------------------|---------------|----------|----------|
| Standard | VUO22-18NO1 | VUO22-18NO1 | Blister | 24 | 461105 |

Equivalent Circuits for Simulation

* on die level

$T_{VJ} = 150\text{ °C}$

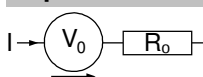

Rectifier

| | | | |
|--------------|--------------------|------|----|
| $V_{0\ max}$ | threshold voltage | 0,84 | V |
| $R_{0\ max}$ | slope resistance * | 27 | mΩ |

Outlines V1-A-Pack

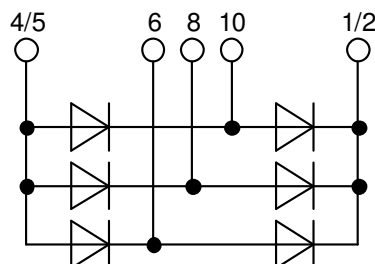
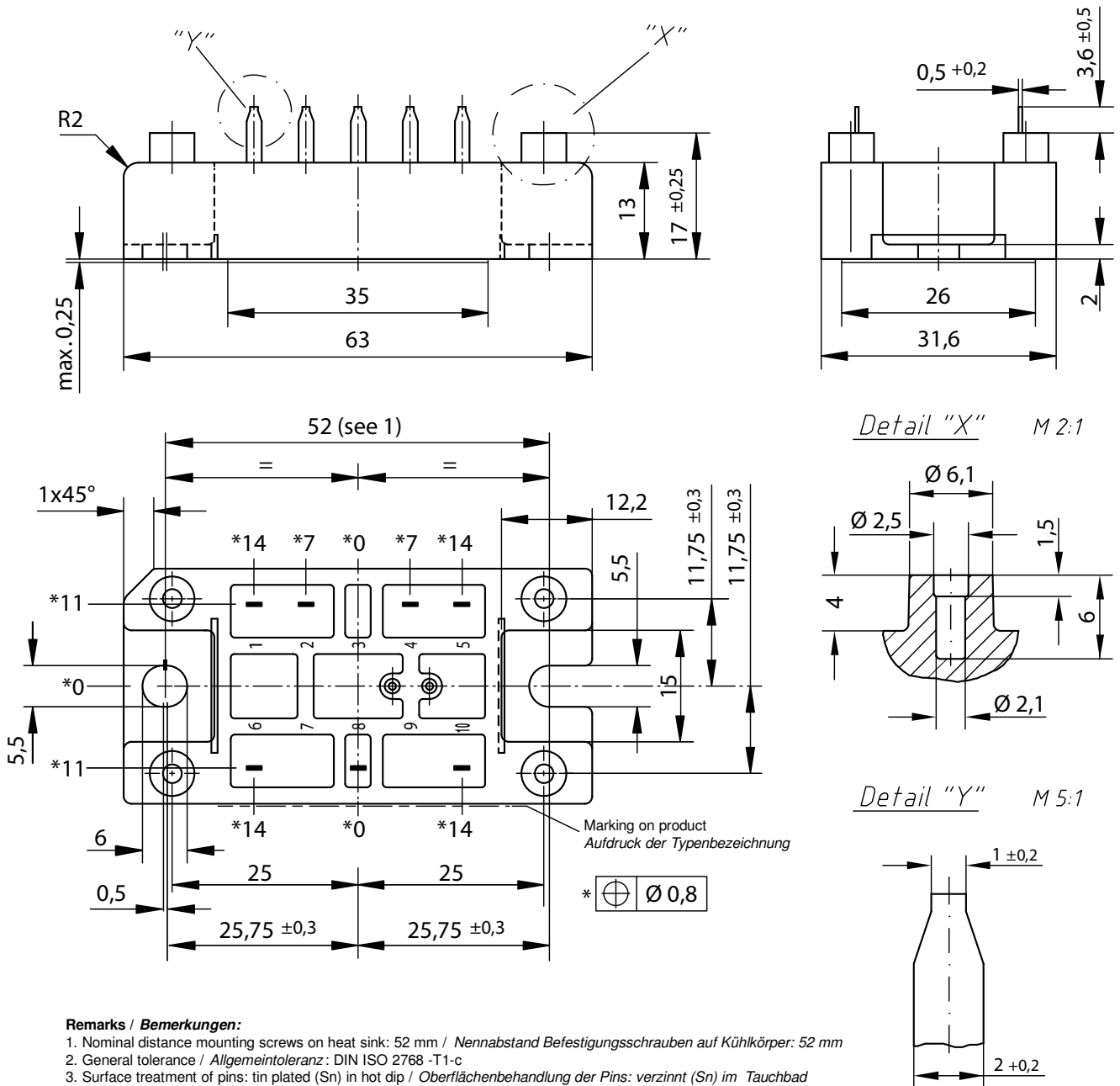

Rectifier

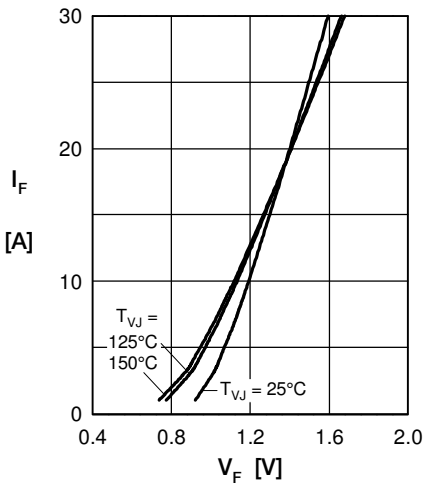

Fig. 1 Forward current vs. voltage drop per diode

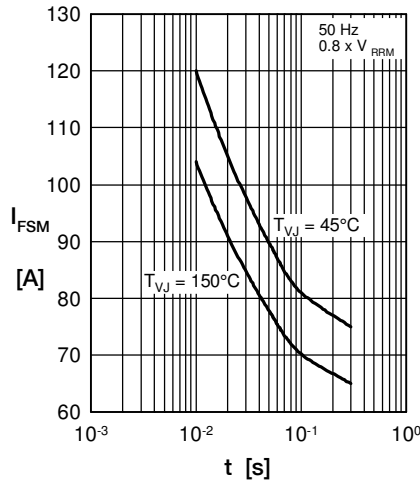

Fig. 2 Surge overload current vs. time per diode

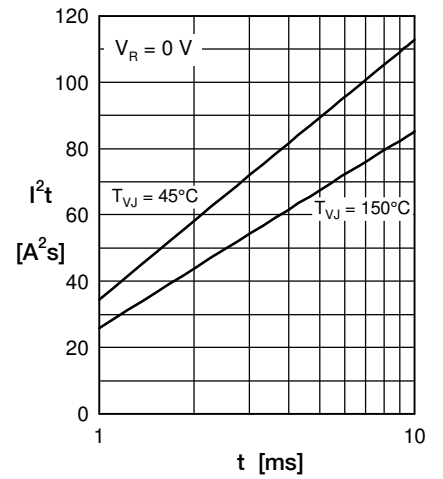

Fig. 3 I²t vs. time per diode

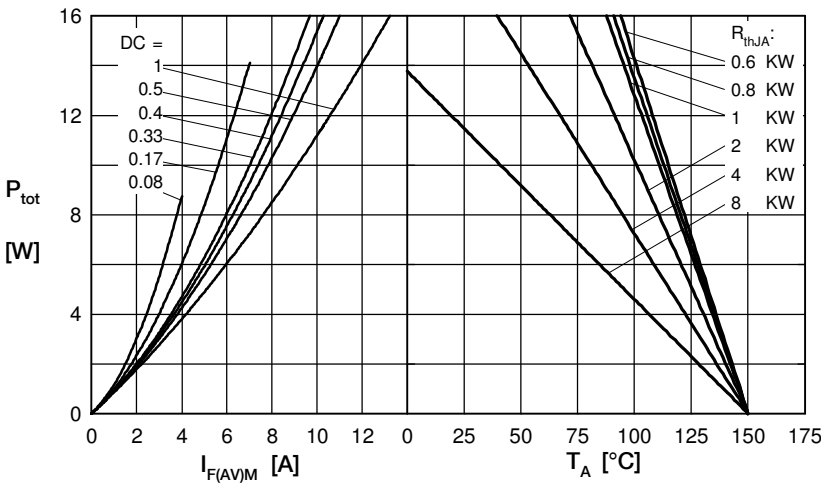

Fig. 4 Power dissipation vs. forward current and ambient temperature per diode

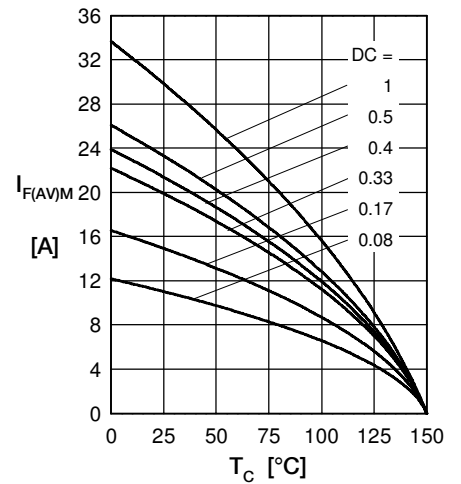

Fig. 5 Max. forward current vs. case temperature per diode

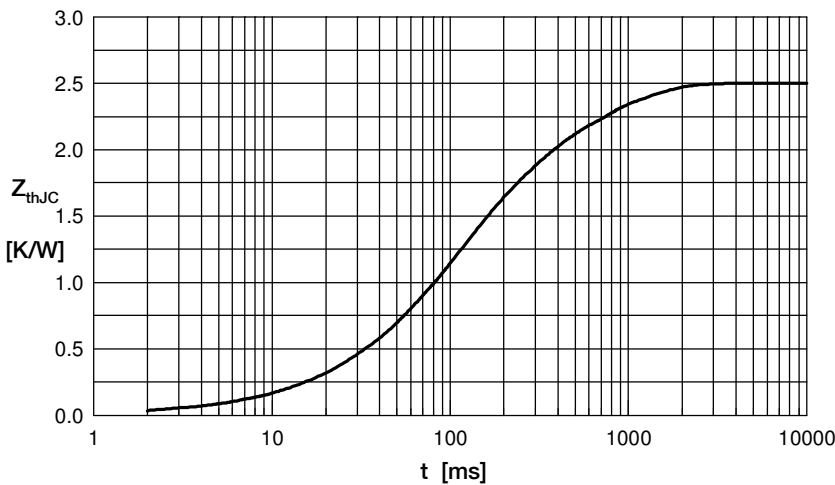

Fig. 6 Transient thermal impedance junction to case vs. time per diode

Constants for Z_{thJC} calculation:

| i | R _{th} (K/W) | t _i (s) |
|---|-----------------------|--------------------|
| 1 | 1.300 | 0.1015 |
| 2 | 0.300 | 0.1026 |
| 3 | 0.350 | 0.4919 |
| 4 | 0.550 | 0.6200 |