

## DETAILS

<b>Product Number</b>	C15014_STRADA-2X2-T4-B
<b>Family</b>	Strada
<b>Type</b>	Lens
<b>Color</b>	clear
<b>Diameter</b>	50x50 mm
<b>Height</b>	9,02 mm
<b>Style</b>	square
<b>Optic Material</b>	PMMA
<b>Holder Material</b>	
<b>Fastening</b>	screw, pin
<b>Status</b>	production ready
<b>ROHS Compliant</b>	Yes
<b>Date Updated</b>	21/04/2016



## OPTICAL PROPERTIES

LED	Viewing Angle	Light Beam	Efficiency	cd/lm	Connector
XT-E	sim: Asymmetric	Asymmetric	-	-	-
XP-G2	sim: Asymmetric	Asymmetric	-	-	-
XHP35 HI	sim: Asymmetric	Asymmetric	-	-	-
XHP35 HI	sim: Asymmetric	Asymmetric	-	-	-
XP-L	sim: Asymmetric	Asymmetric	-	-	-
XP-L HI	sim: Asymmetric	Asymmetric	sim: 92 %	sim: 0.980	-
XM-L	sim: Asymmetric	Asymmetric	-	-	-
XP-L2	Asymmetric deg	Asymmetric	94 %	0.650	-
LUXEON TX	Asymmetric deg	Asymmetric	94 %	1.100	-
LUXEON 5050	Asymmetric deg	Asymmetric	94 %	0.640	-
NCSxx19B	sim: Asymmetric	Asymmetric	-	-	-
NVSxx19B/NVSxx19C	sim: Asymmetric	Asymmetric	-	-	-
NVSW3x9A	Asymmetric deg	Asymmetric	94 %	0.830	-
NVSxE21A	asym deg	Asymmetric	94 %	1.400	-
NWSx229A	sim: Asym	Asymmetric	sim: 87 %	sim: 0.640	-
Oslon Square Gen3	sim: Asymmetric	Asymmetric	-	-	-
Oslon Square PC	sim: Asymmetric	Asymmetric	-	-	-
Duris S8	sim: Asymmetric	Asymmetric	-	-	-
LH351D	Asymmetric deg	Asymmetric	94 %	0.630	-
LH351C	Asymmetric deg	Asymmetric	94 %	0.900	-
LH508A	Asymmetric deg	Asymmetric	94 %	0.620	-
RLE G1 49x223mm 4000lm xxx EXC OT	Asymmetric deg	Asymmetric	94 %	1.100	-
RLE G1 49x245mm 4000lm xxx EXC OT	Asymmetric deg	Asymmetric	94 %	1.100	-
RLE G1 49x121mm 2000lm xxx EXC OT	Asymmetric deg	Asymmetric	94 %	1.100	-
RLE G1 49x133mm 2000lm xxx EXC OT	Asymmetric deg	Asymmetric	94 %	1.100	-



**PRODUCT DATASHEET**  
**Strada series**  
last update 21/4/2016

**OPTICAL PROPERTIES**

LED	Viewing Angle	Light Beam	Effi- ciency	cd/lm	Connector
-----	------------------	---------------	-----------------	-------	-----------

D

C

B

A

4

4

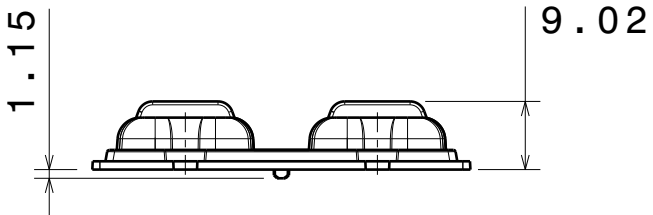

Front view

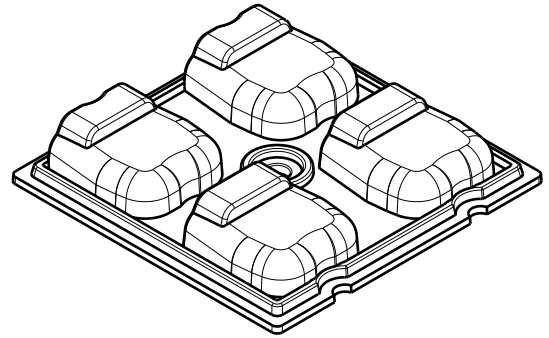

Isometric view

3

3

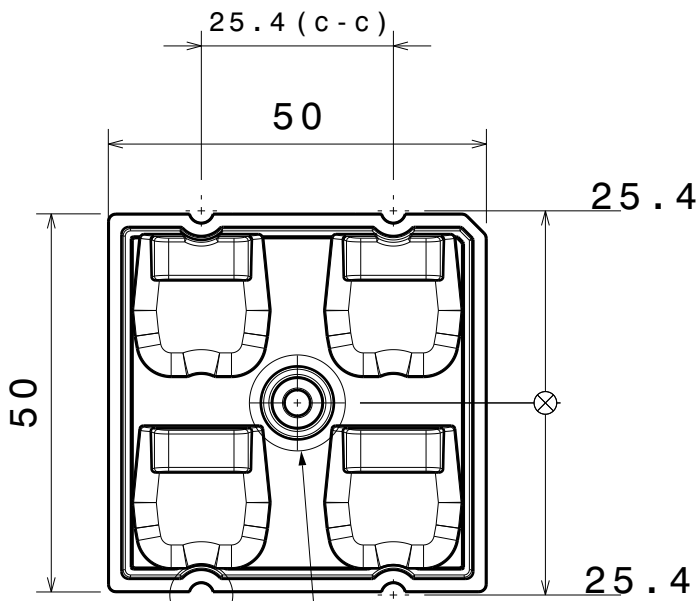

Top view

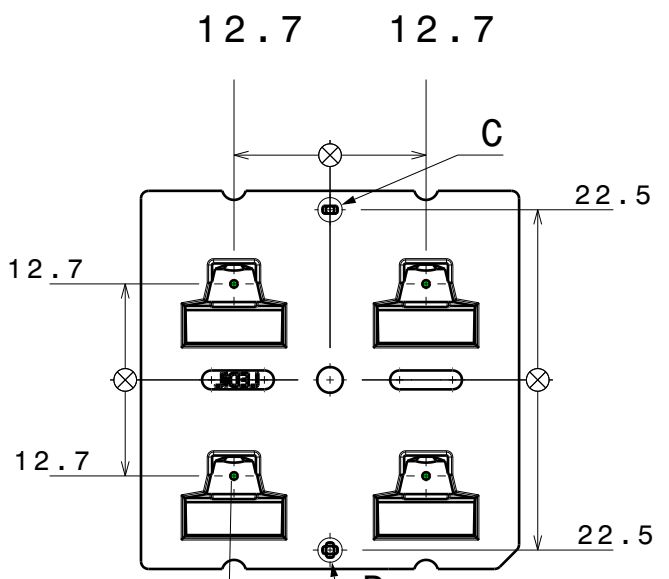

Bottom view

2

2

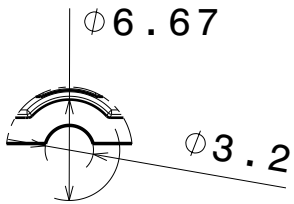

Detail A

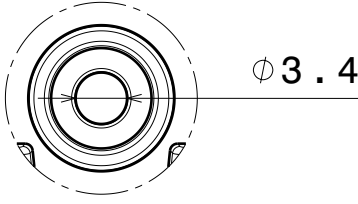

Detail B

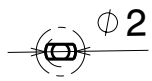

Detail C

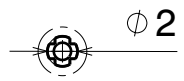

Detail D

Tolerances if not otherwise shown  
 According to DIN ISO 2768-1  
 Linear measures:  
 up to 30mm class M, otherwise class C  
 According to DIN ISO 2768-2  
 Form and position: class L

**LEDiL** LediL Oy  
 Salorankatu 10  
 FIN 24240 SALO  
 Finland

THIRD ANGLE PROJECTION:

DRAWING TITLE  
**C15014\_STRADA-2X2-T4-B**

This drawing is the property of LEDiL Oy. It may not be reproduced, copied or communicated without a written agreement with LEDiL Oy.

SIZE	PART NUMBER
A4	C15014

SCALE	1:1	WEIGHT	9,39 g	SHEET	1/1
-------	-----	--------	--------	-------	-----

1

1

D

A

Luminaire: Ledil Oy C15014\_STRADA-2X2-T4-B\_simulated\_XP-L HI  
Lamps: 1 x Cree XP-L HI

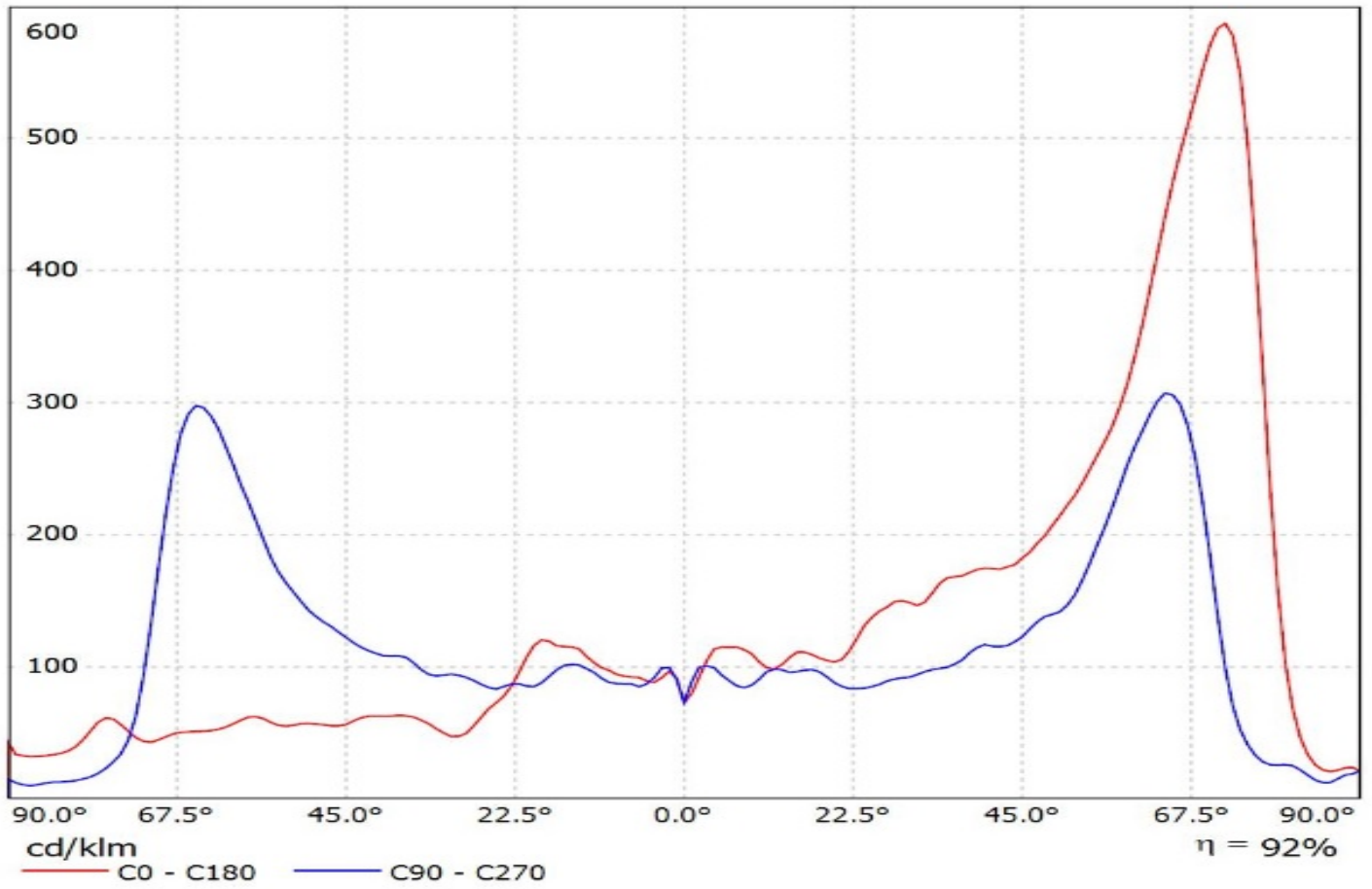

Luminaire: Ledil C15014\_STRADA-2X2-T4-B\_(XP-L2)

Lamps: 1 x Cree\_XP-L2\_2x2\_(XPLBWT-00-0000-000BV50E3)550.93lm@250mA\_P=2.7815W\_I=0.25A

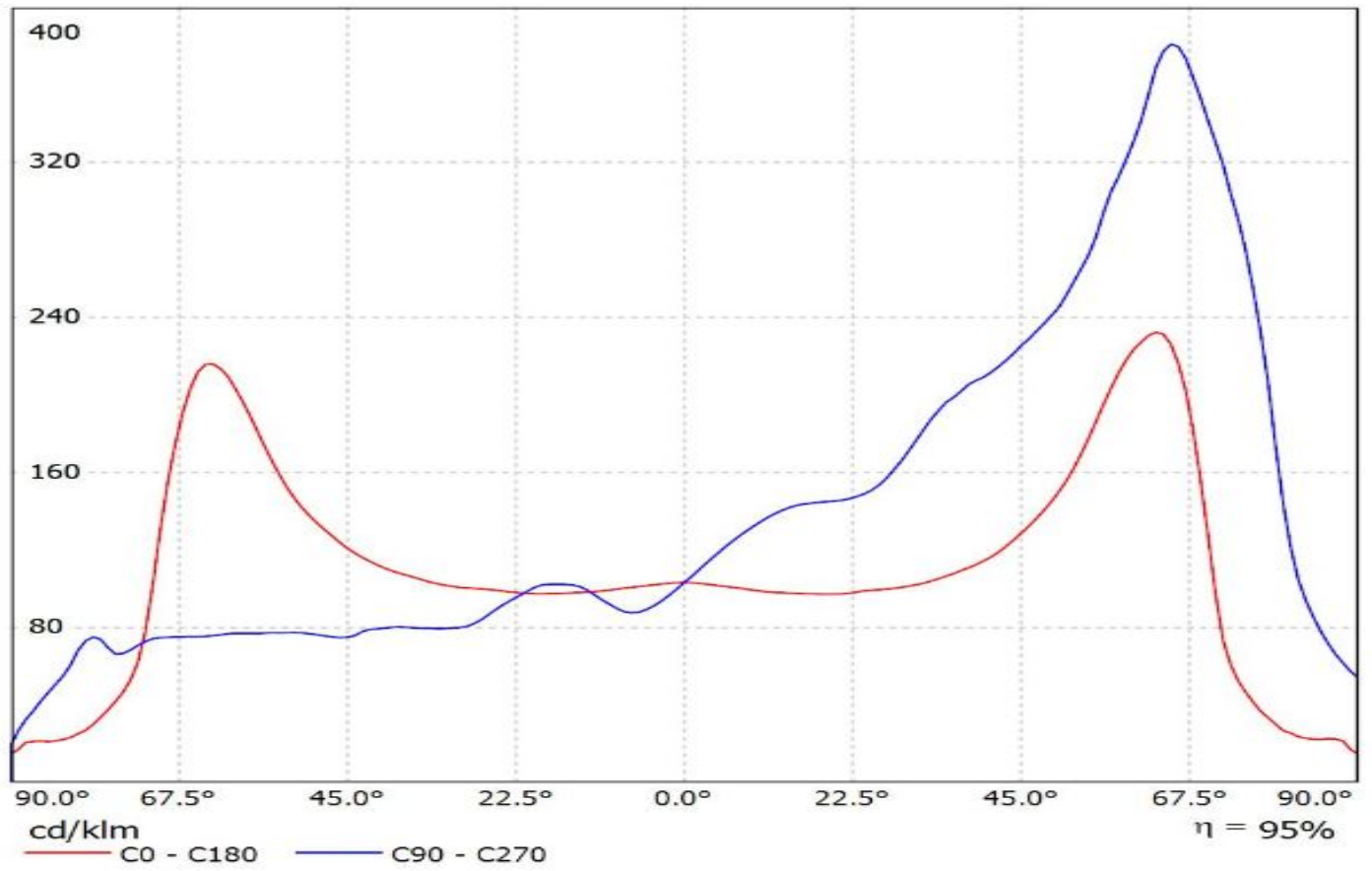

Luminaire: Ledil C15014\_STRADA-2X2-T4-B\_(LUXEON\_TX)  
Lamps: 1 x LUXEON\_TX\_2x2\_(L1T2-3585)\_330.32lm@250mA\_P=2.8W\_I=0.25A

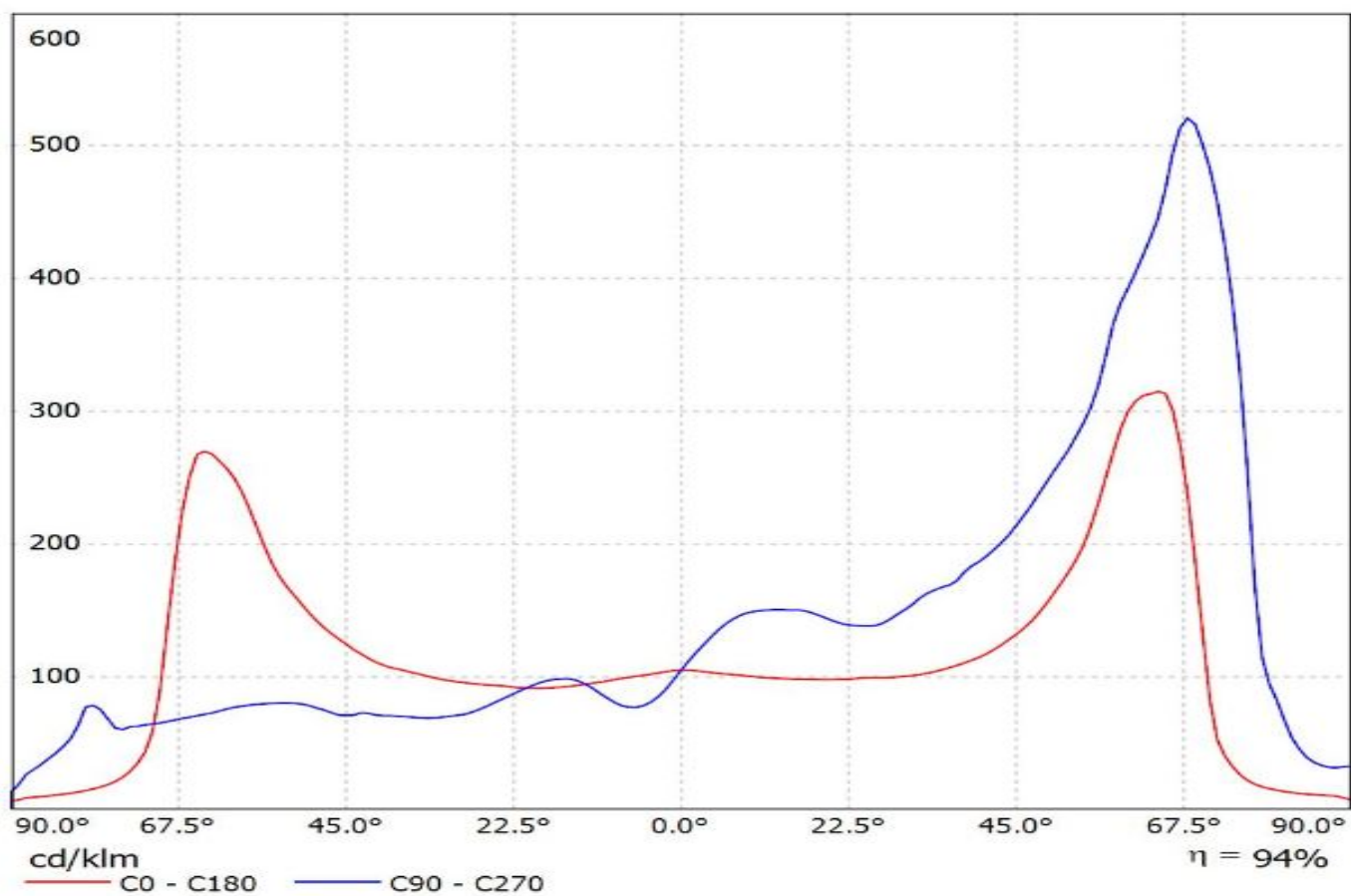

Luminaire: LEDiL Oy C15014\_STRADA-2X2-T4-B\_(Luxeon\_5050)

Lamps: 1 x Luxeon\_5050\_2x2\_1251.02lm@80mA\_CCT=5700K\_P=7.27443W\_I=0.080A\_70CRI

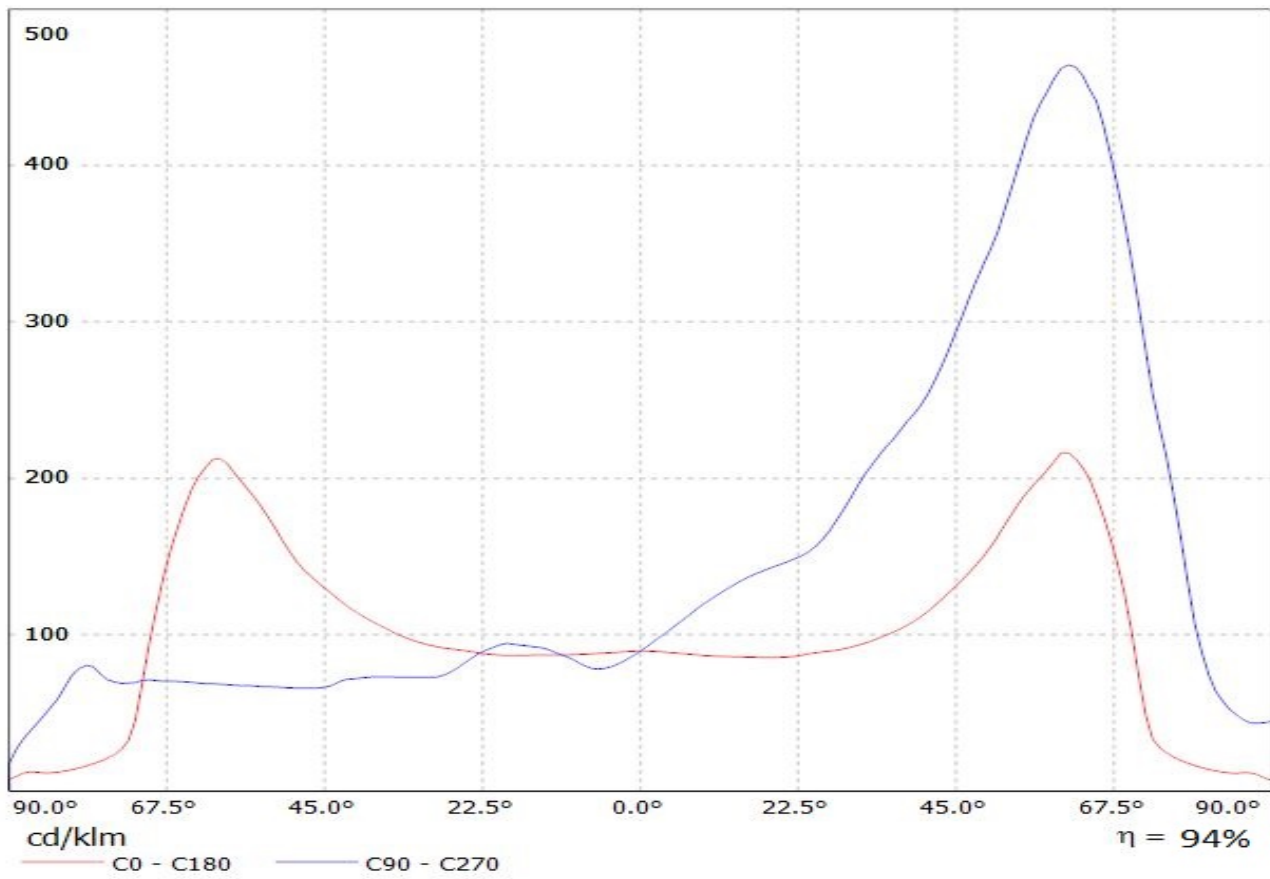

Luminaire: Ledil C15014\_STRADA-2X2-T4-B\_(NVSW319AE)  
Lamps: 1 x Nichia\_NVSW319AE\_(sm405D440f2L2R70)

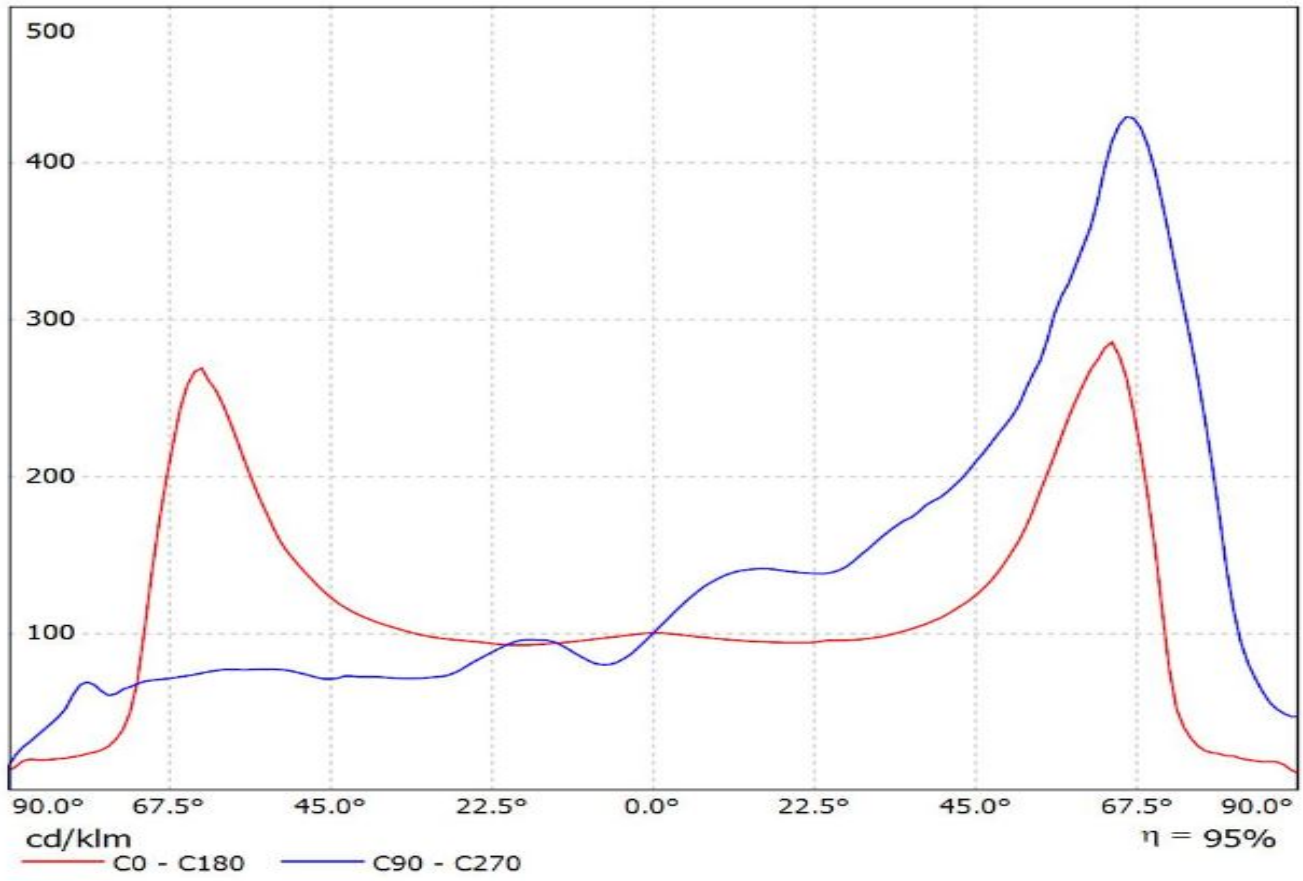



Luminaire: LEDiL Oy C15014\_STRADA-2X2-T4-B\_(E21A)  
Lamps: 1 x Nichia\_E21A\_452.248lm@250mA\_2.805W\_I=0.250A

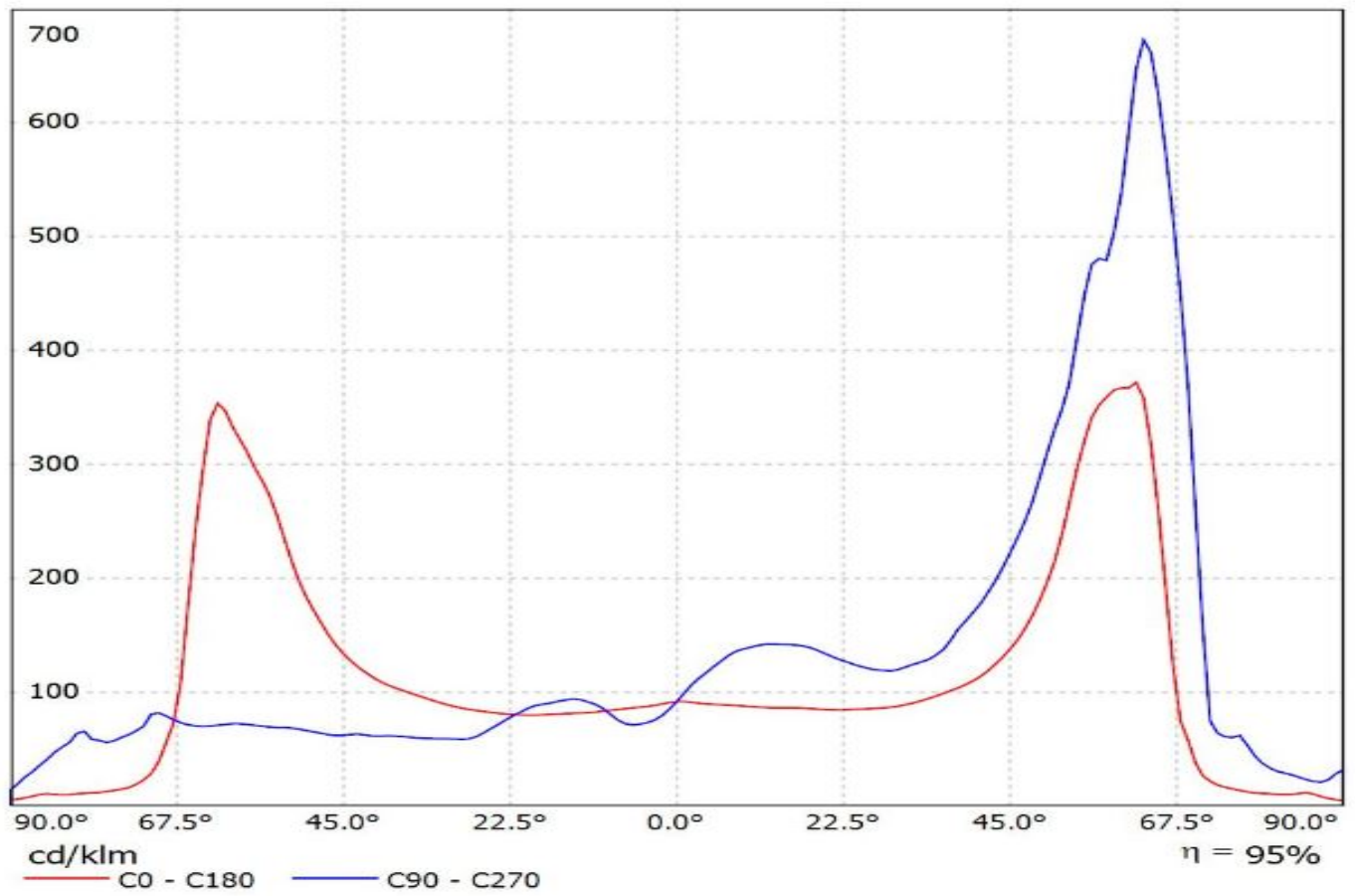

Luminaire: Ledil Oy C15014\_STRADA-2X2-T4-B\_(NWSx229A)\_SIMULATED  
Lamps: 1 x Nichi NWSW229A

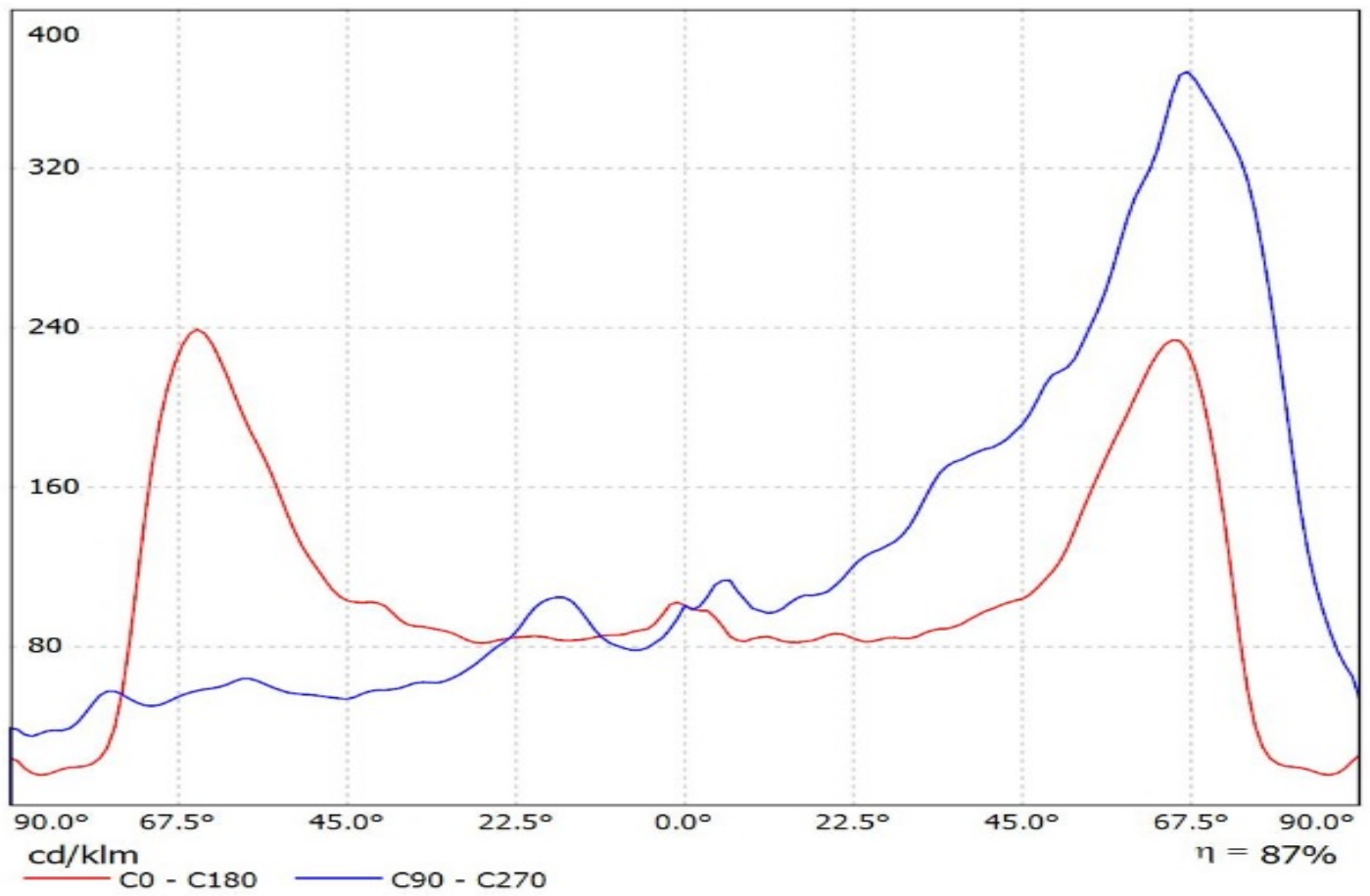

Luminaire: LEDiL Oy C15014\_STRADA-2X2-T4-B\_(LH351D)  
Lamps: 1 x Samsung\_LH351D\_524.264lm@250mA\_P=2.7523W\_I=0.250A

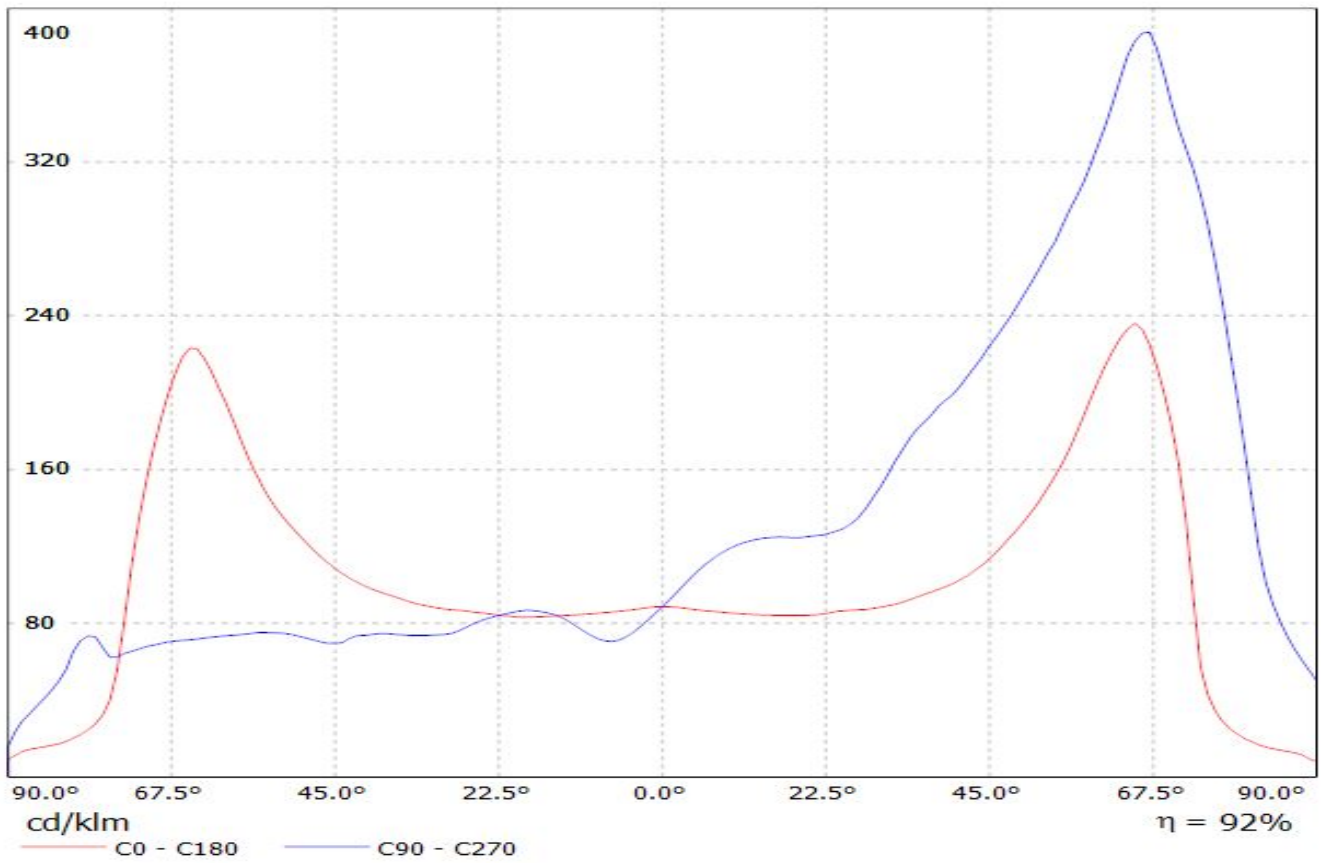

Luminaire: Ledil C15014\_STRADA-2X2-T4-B\_(LH351C)  
Lamps: 1 x Samsung\_LH351C\_518.223lm@250mA\_P=2.85225W\_I=0.25A

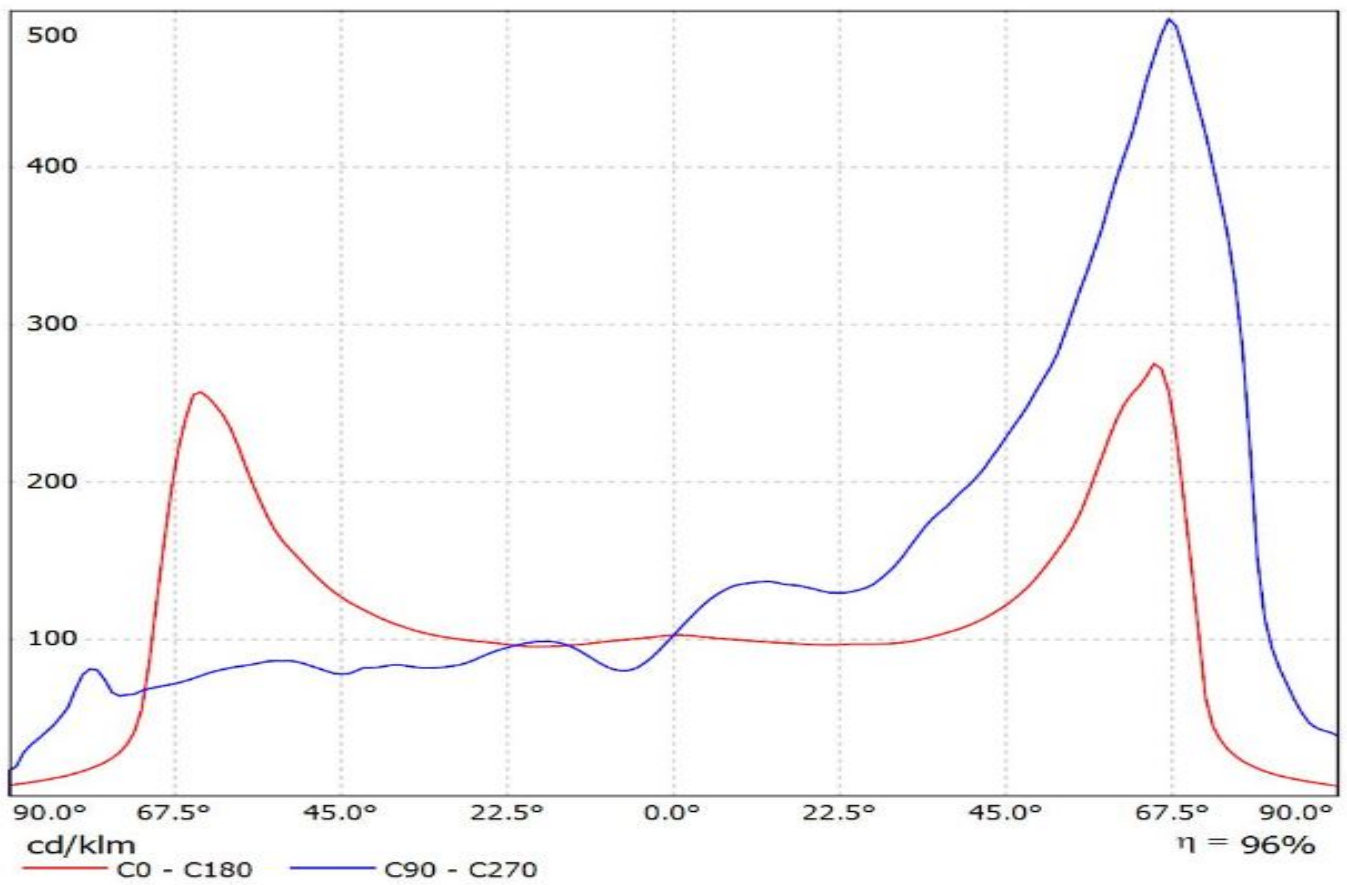

Luminaire: Ledil C15014\_STRADA-2X2-T4-B\_(LH508A)

Lamps: 1 x Samsung\_LH508A\_2x2\_2060.04lm@160mA\_CCT=5000K\_CRI=80\_P=15.5405W\_I=0.16A

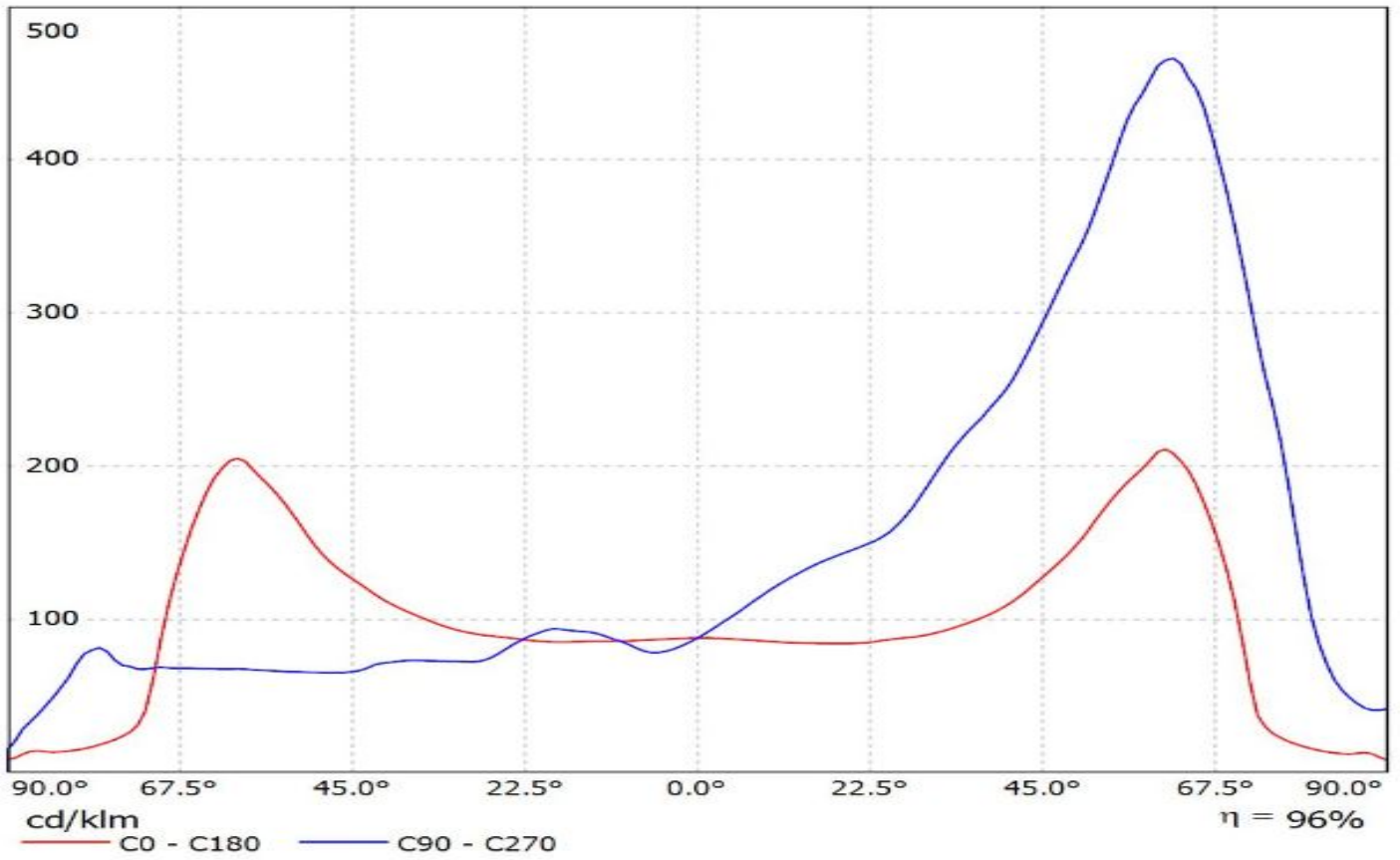

Luminaire: LEDiL Oy C15014\_STRADA-2X2-T4-B\_(Tridonic\_Module\_RLE\_G1)  
Lamps: 1 x Tridonic\_Module\_RLE\_G1\_4594.42lm@700mA\_P=32.1515W\_I=0.700A

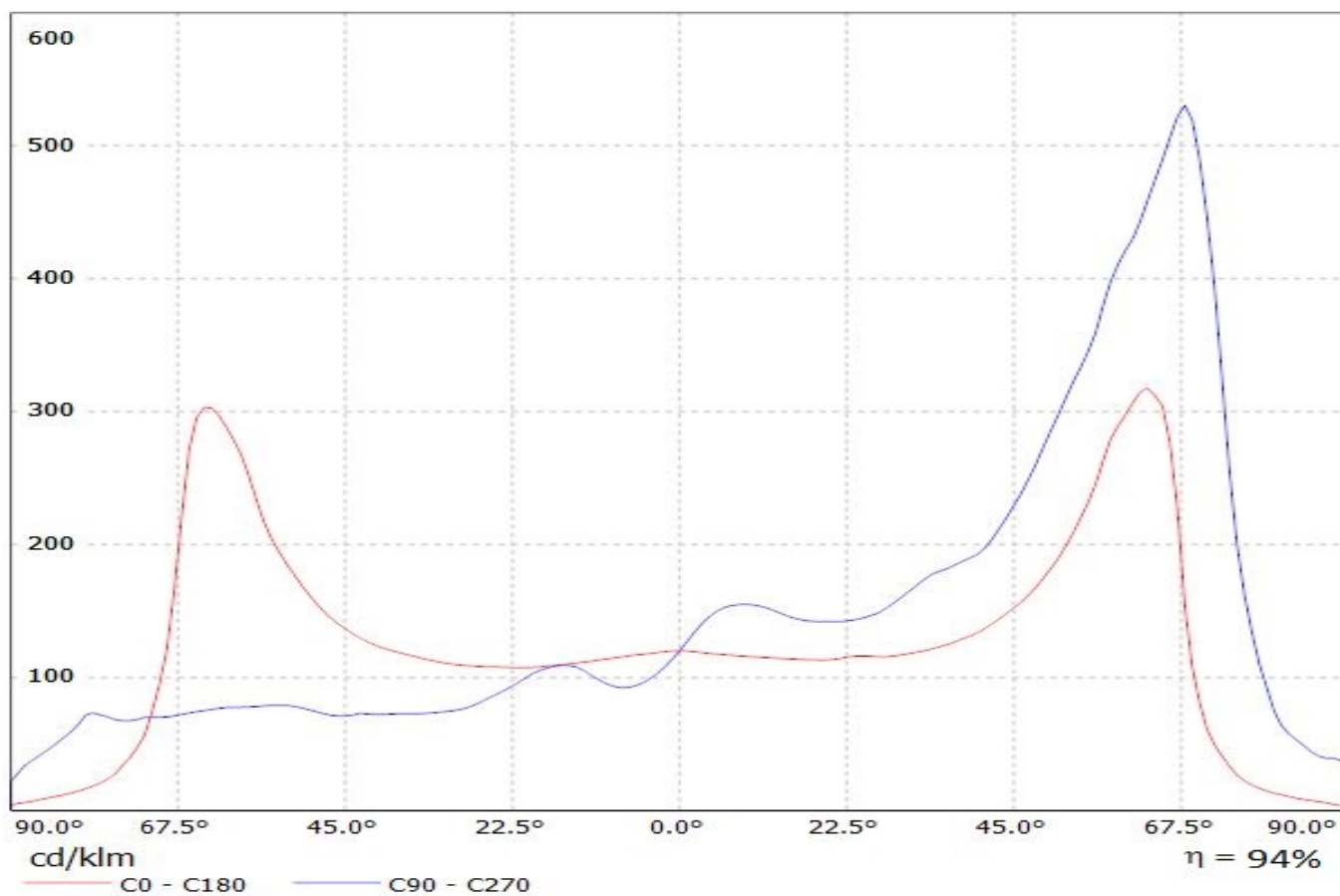

Luminaire: LEDiL Oy C15014\_STRADA-2X2-T4-B\_(Tridonic\_Module\_RLE\_G1)  
Lamps: 1 x Tridonic\_Module\_RLE\_G1\_4594.42lm@700mA\_P=32.1515W\_I=0.700A

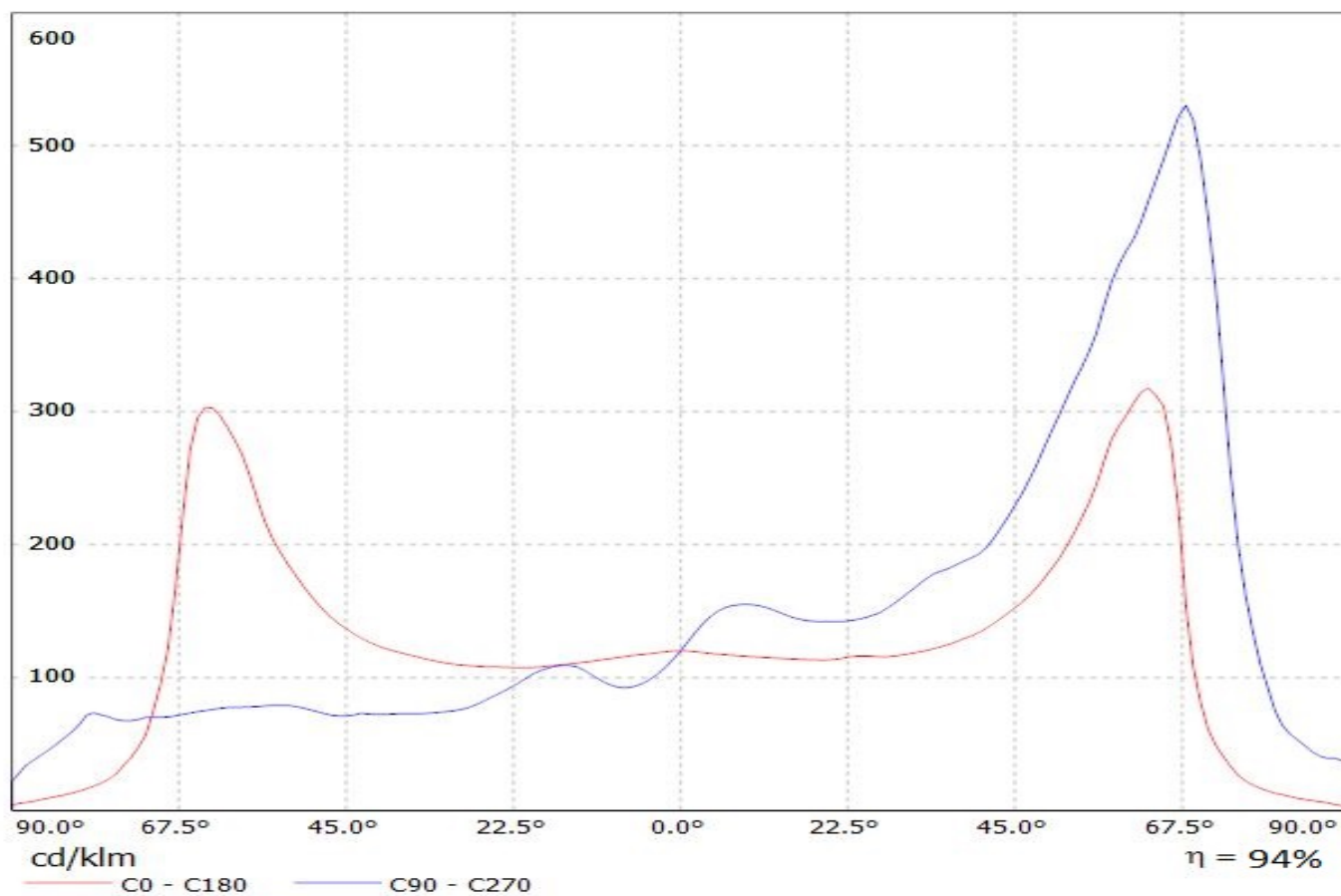

Luminaire: LEDiL Oy C15014\_STRADA-2X2-T4-B (Tridonic Module\_RLE\_G1)  
Lamps: 1 x Tridonic\_Module\_RLE\_G1\_2288lm@700mA\_P=16W\_I=0.700A

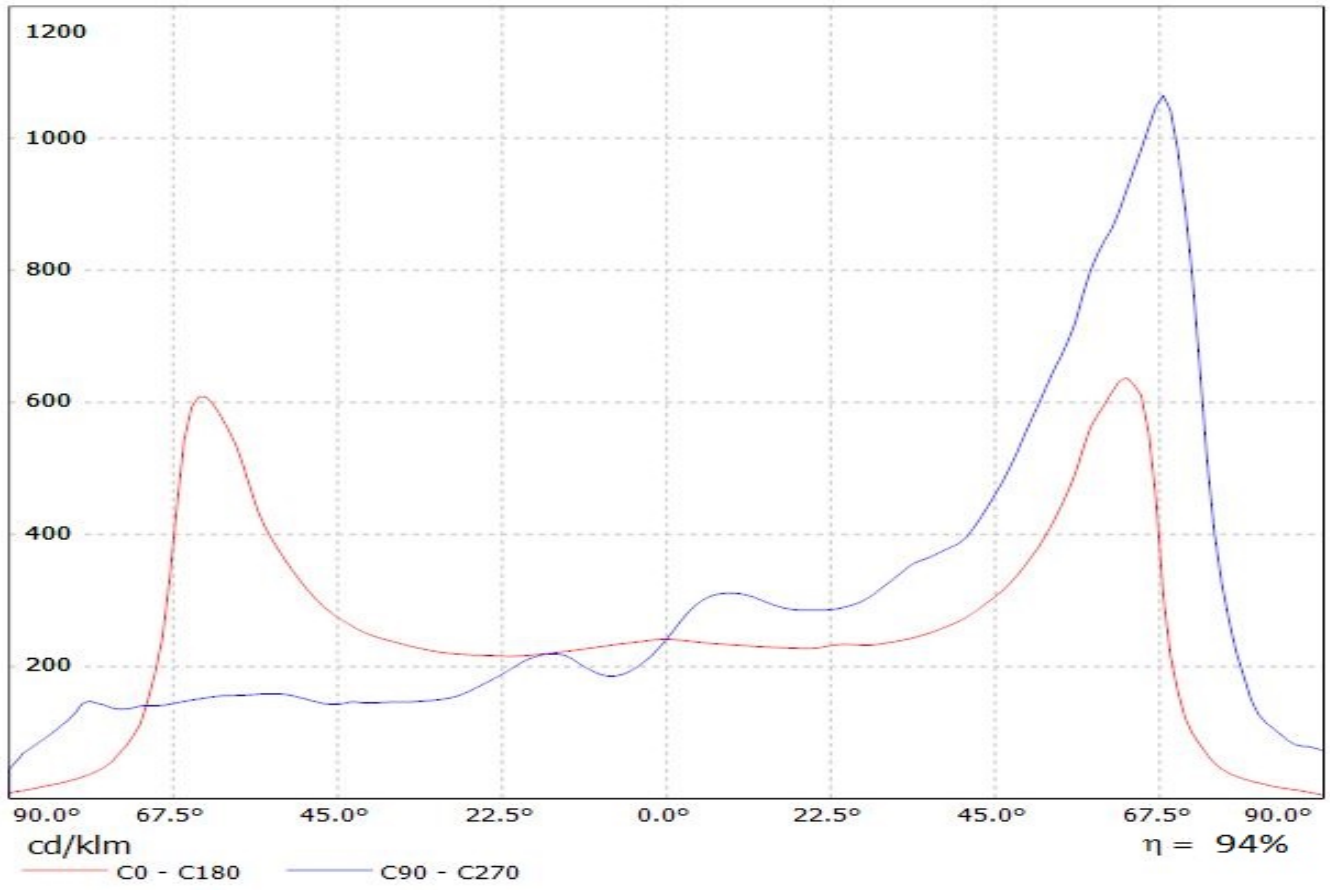



Luminaire: LEDiL Oy C15014\_STRADA-2X2-T4-B (Tridonic Module\_RLE\_G1)  
Lamps: 1 x Tridonic\_Module\_RLE\_G1\_2288lm@700mA\_P=16W\_I=0.700A

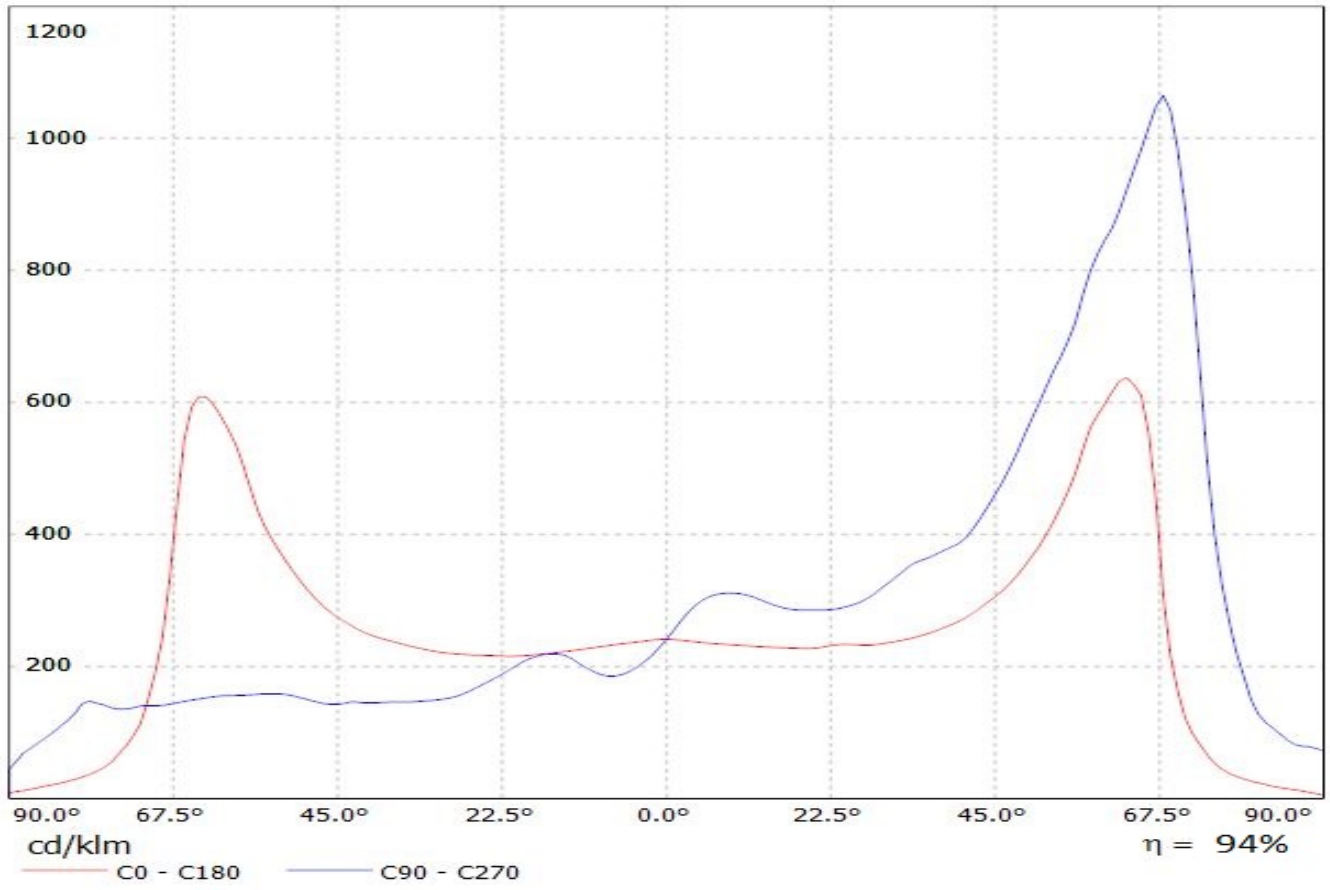

Luminaire: Ledil Oy C15014\_STRADA-2X2-T4-B\_simulated\_XT-E  
Lamps: 1 x Cree XT-E

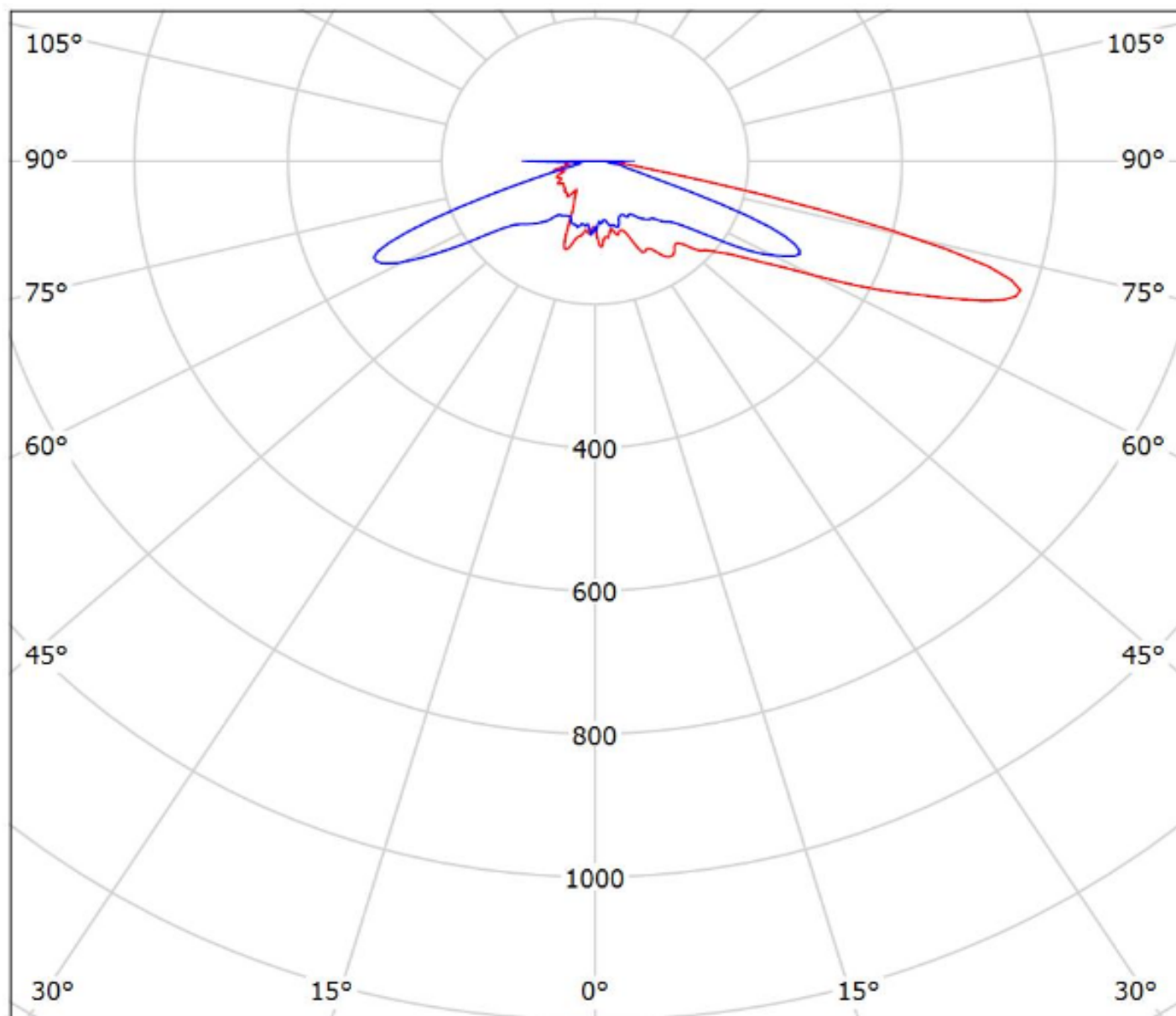

cd/klm

— C0 - C180 — C90 - C270

$\eta = 91\%$

Luminaire: Ledil Oy C15014\_STRADA-2X2-T4-B\_simulated\_XP-G2  
Lamps: 1 x Cree XP-G2

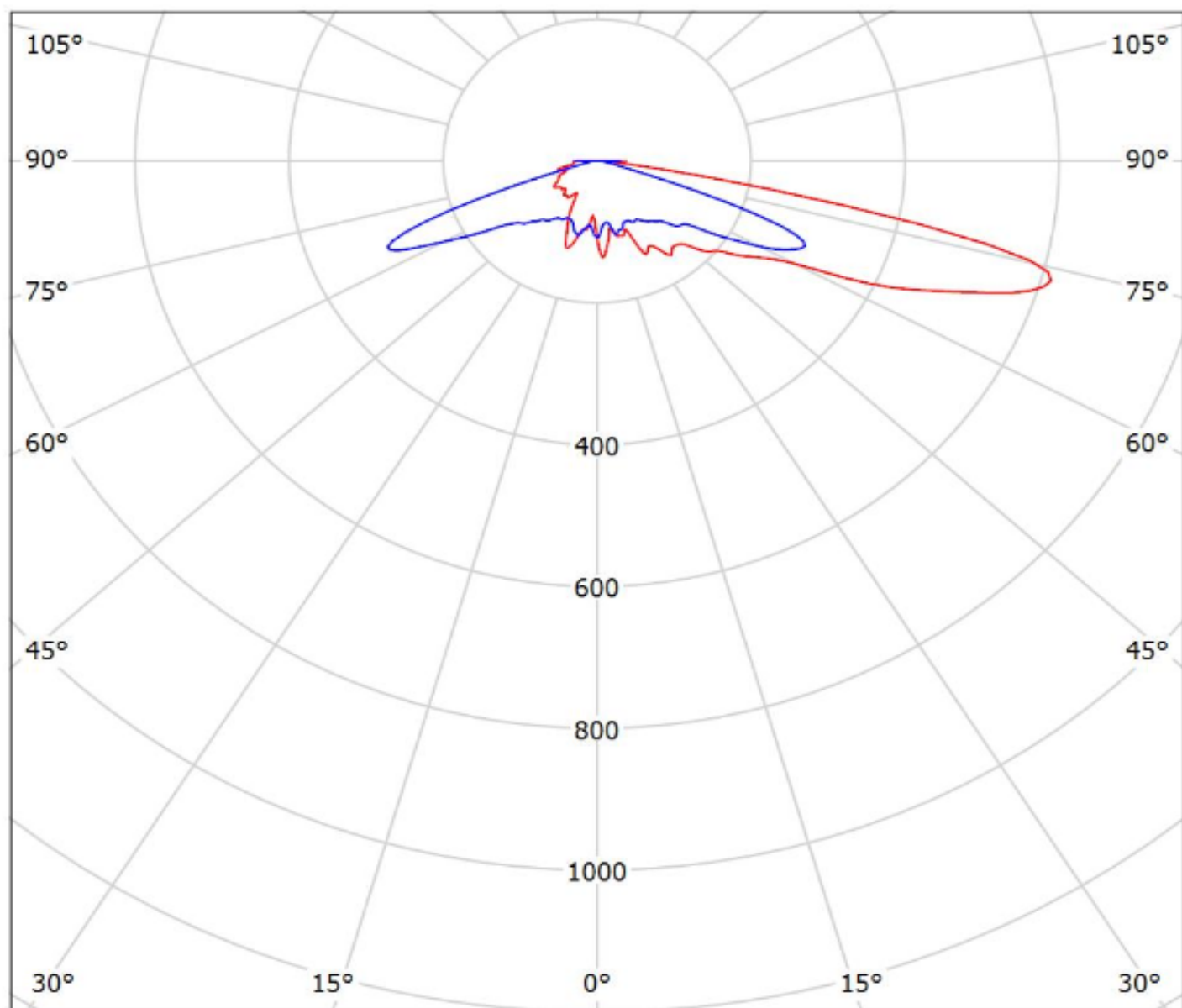

cd/klm

— C0 - C180 — C90 - C270

$\eta = 91\%$

Luminaire: Ledil Oy C15014\_STRADA-2X2-T4-B\_simulated\_XHP-35 HD  
Lamps: 1 x Cree XHP-35 HD

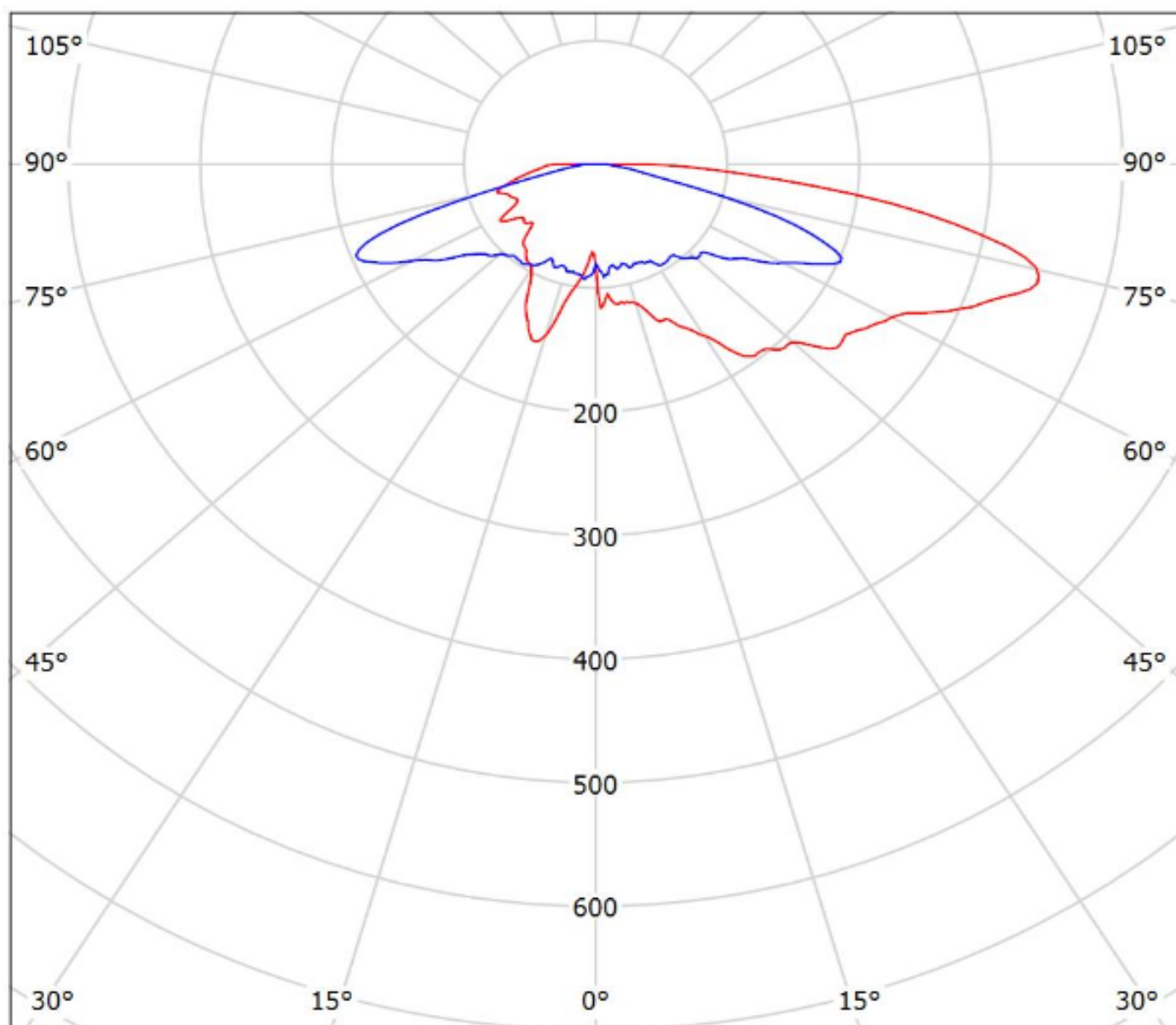

cd/klm

— C0 - C180 — C90 - C270

$\eta = 88\%$

Luminaire: Ledil Oy C15014\_STRADA-2X2-T4-B\_simulated\_XHP-35 HI

Lamps: 1 x Cree XHP-35 HI

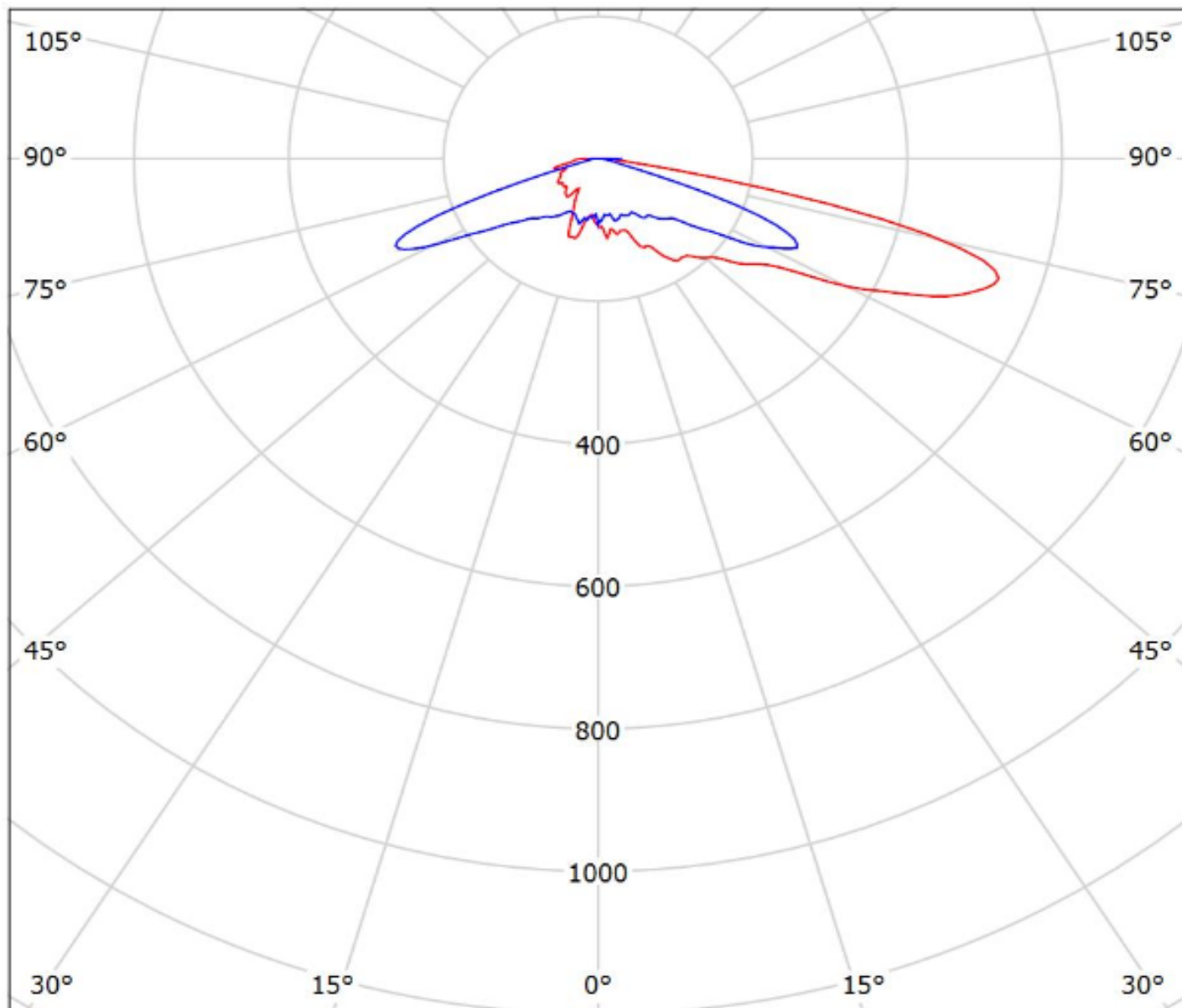

cd/klm

— C0 - C180 — C90 - C270

$\eta = 91\%$

Luminaire: Ledil Oy C15014\_STRADA-2X2-T4-B\_simulated\_XP-L

Lamps: 1 x Cree XP-L

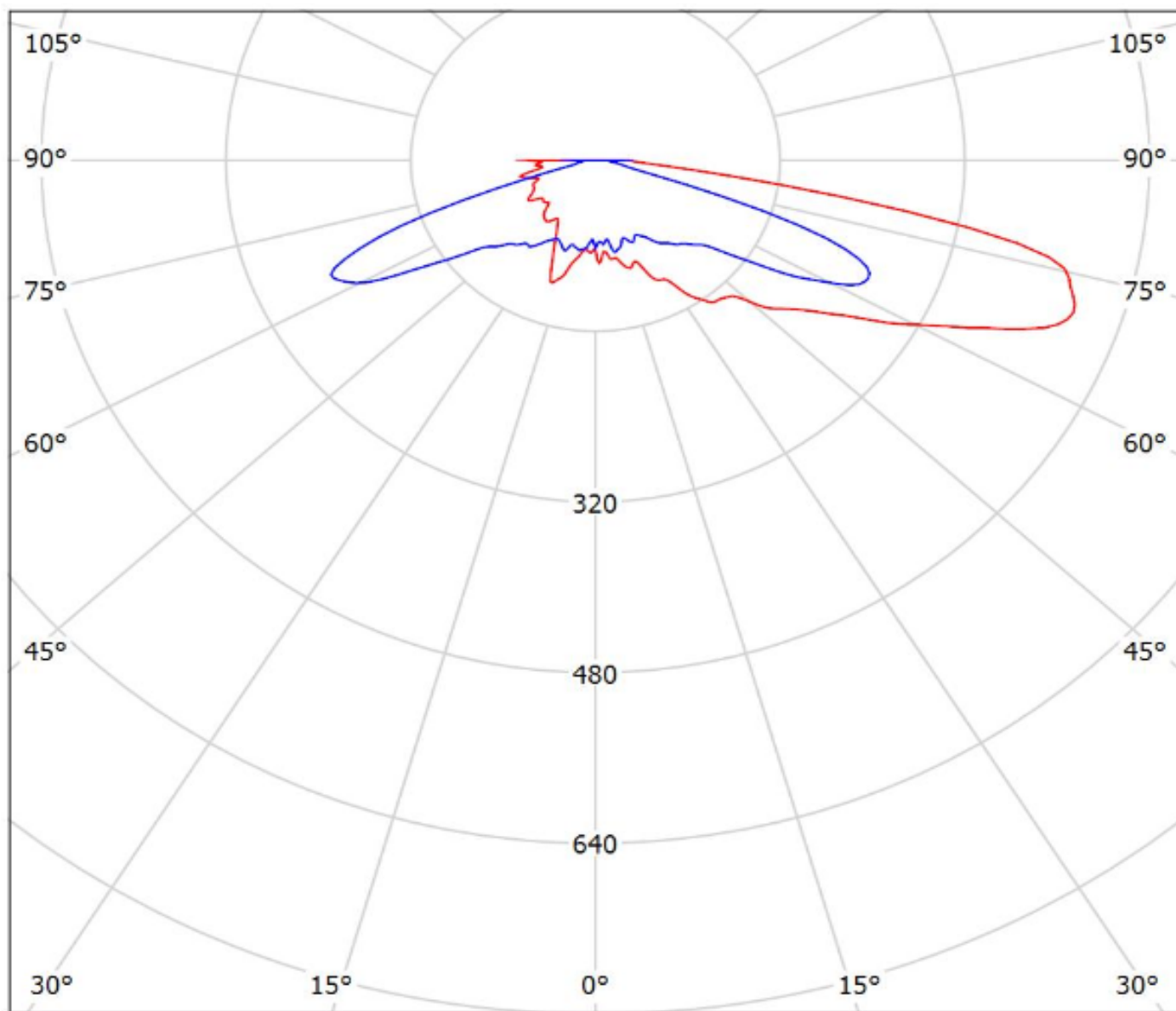

cd/klm

— C0 - C180

— C90 - C270

η = 90%

Luminaire: Ledil Oy C15014\_STRADA-2X2-T4-B\_simulated\_XP-L HI

Lamps: 1 x Cree XP-L HI

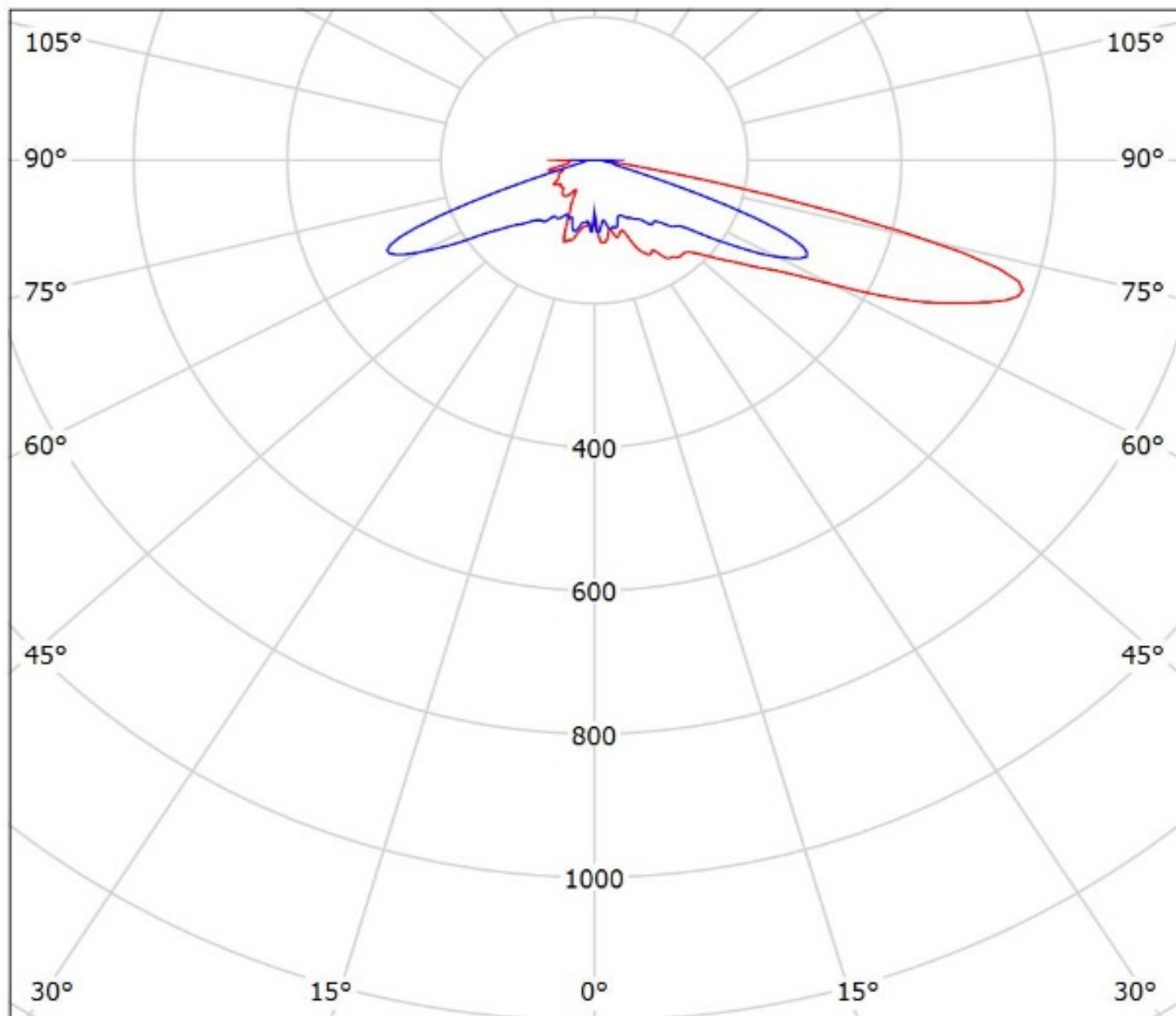

cd/klm

— C0 - C180 — C90 - C270

$\eta = 92\%$

Luminaire: Ledil Oy C15014\_STRADA-2X2-T4-B\_simulated\_XM-L  
Lamps: 1 x Cree XM-L

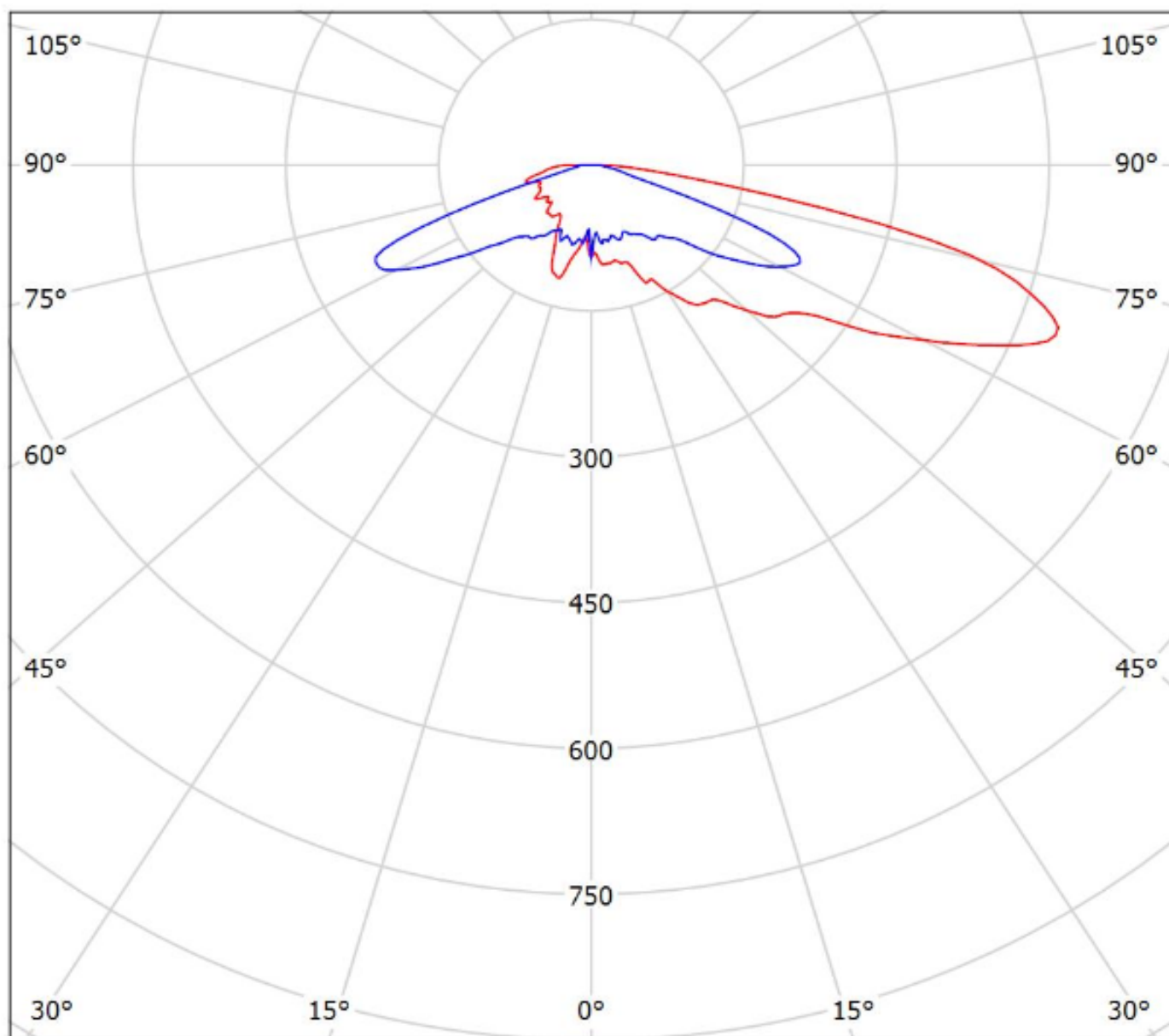

cd/klm

— C0 - C180 — C90 - C270

$\eta = 90\%$



Luminaire: Ledil C15014\_STRADA-2X2-T4-B\_(XP-L2)

Lamps: 1 x Cree\_XP-L2\_2x2\_(XPLBWT-00-0000-000BV50E3)550.93lm@250mA\_P=2.7815W\_I=0.25A

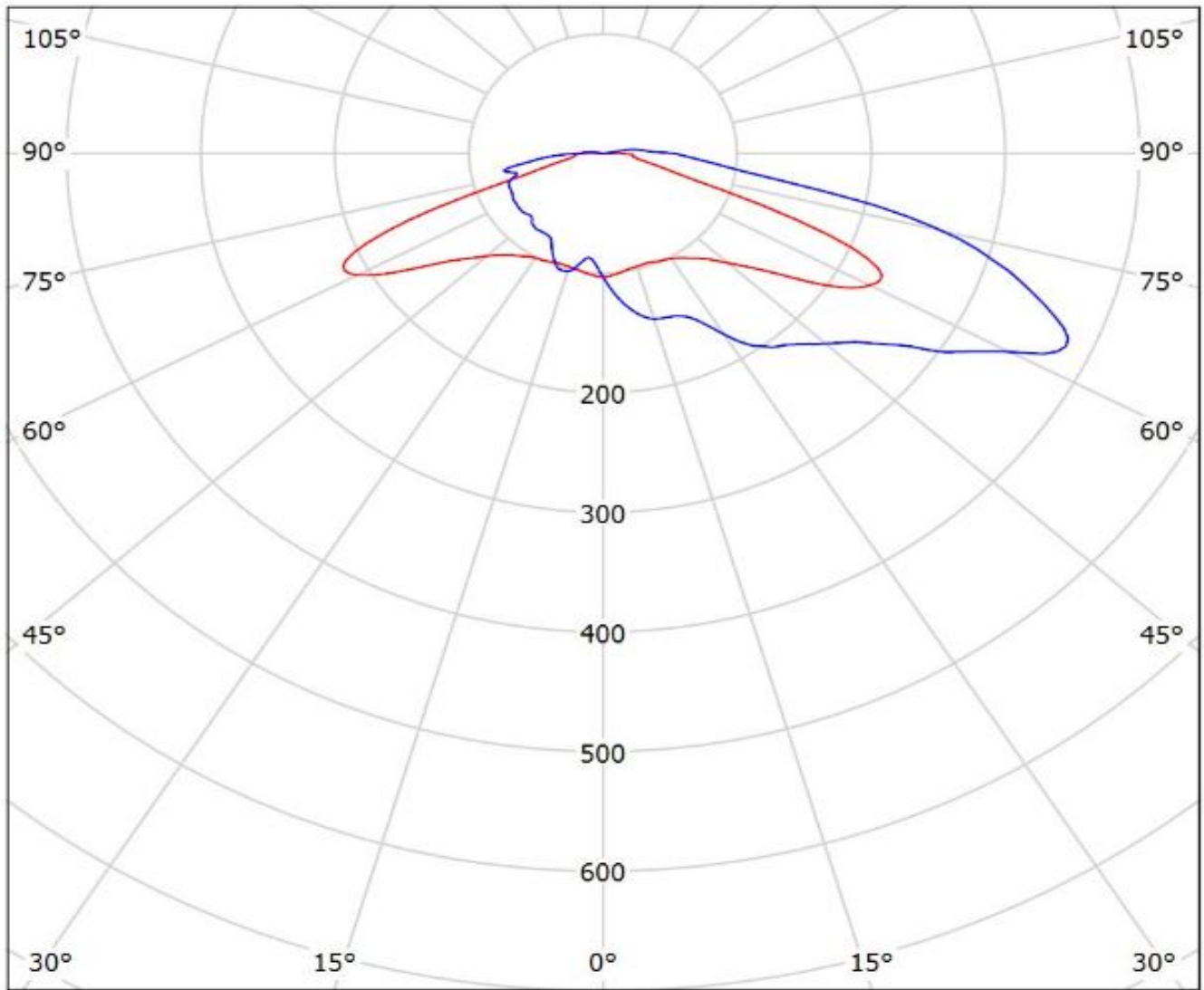

cd/klm

— C0 - C180

— C90 - C270

$\eta = 95\%$

Luminaire: Ledil C15014\_STRADA-2X2-T4-B\_(LUXEON\_TX)

Lamps: 1 x LUXEON\_TX\_2x2\_(L1T2-3585)\_330.32lm@250mA\_P=2.8W\_I=0.25A

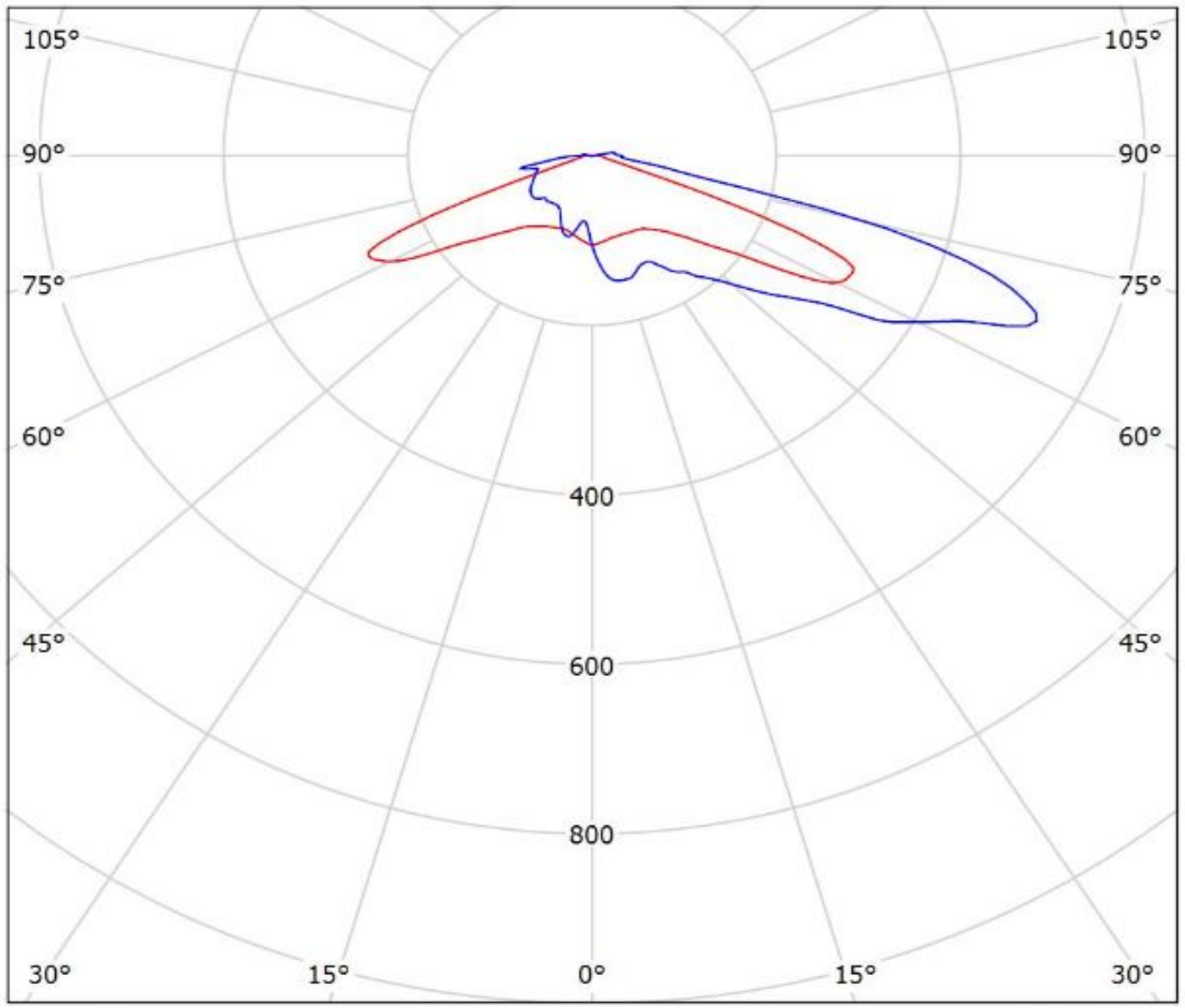

cd/klm

— C0 - C180

— C90 - C270

$\eta = 94\%$

Luminaire: LEDiL Oy C15014\_STRADA-2X2-T4-B\_(Luxeon\_5050)

Lamps: 1 x Luxeon\_5050\_2x2\_1251.02lm@80mA\_CCT=5700K\_P=7.27443W\_I=0.080A\_70CRI

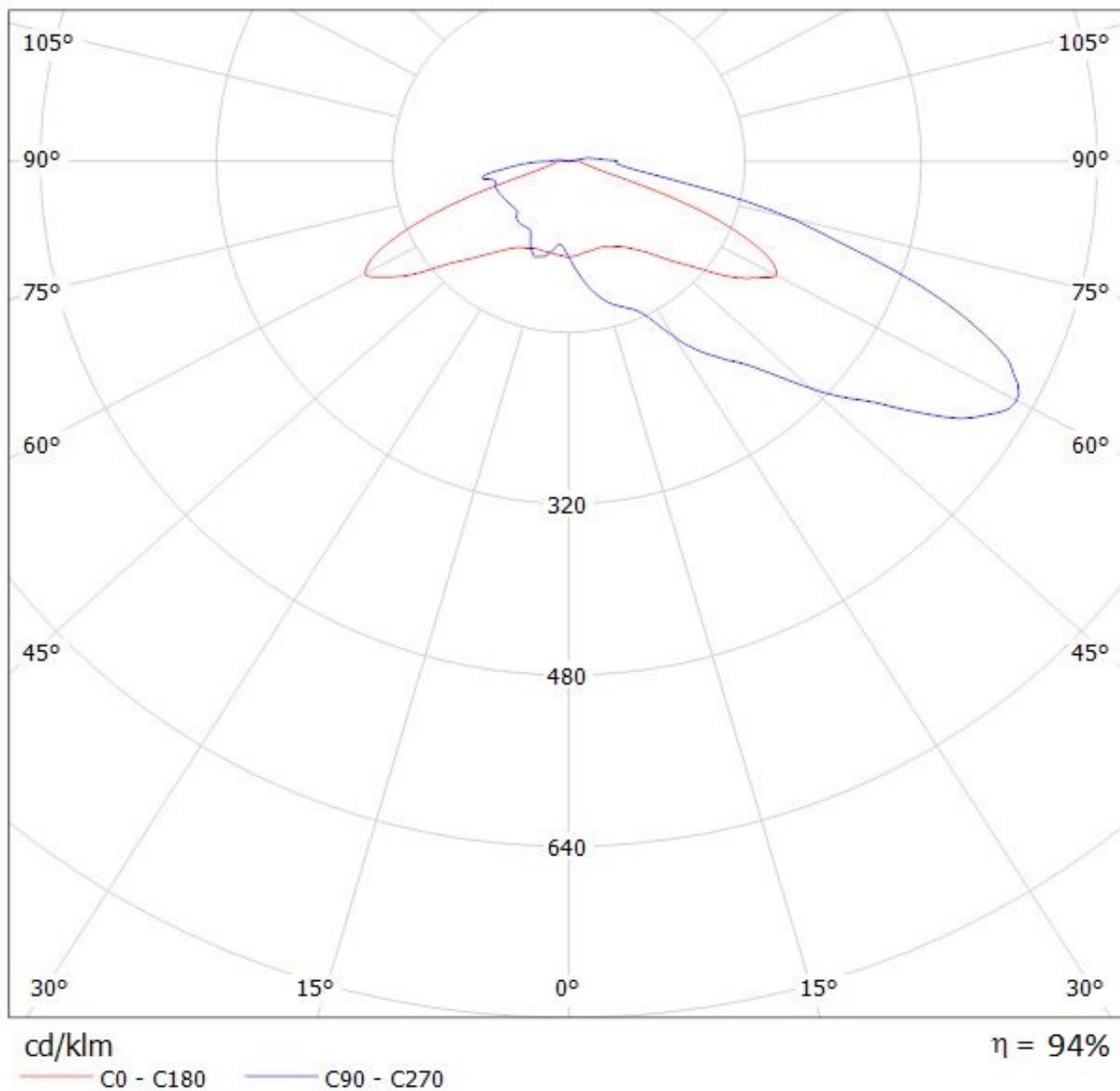

Luminaire: Ledil Oy C15014\_STRADA-2X2-T4-B\_simulated\_NCSW219B  
Lamps: 1 x Nichia NCSW219B

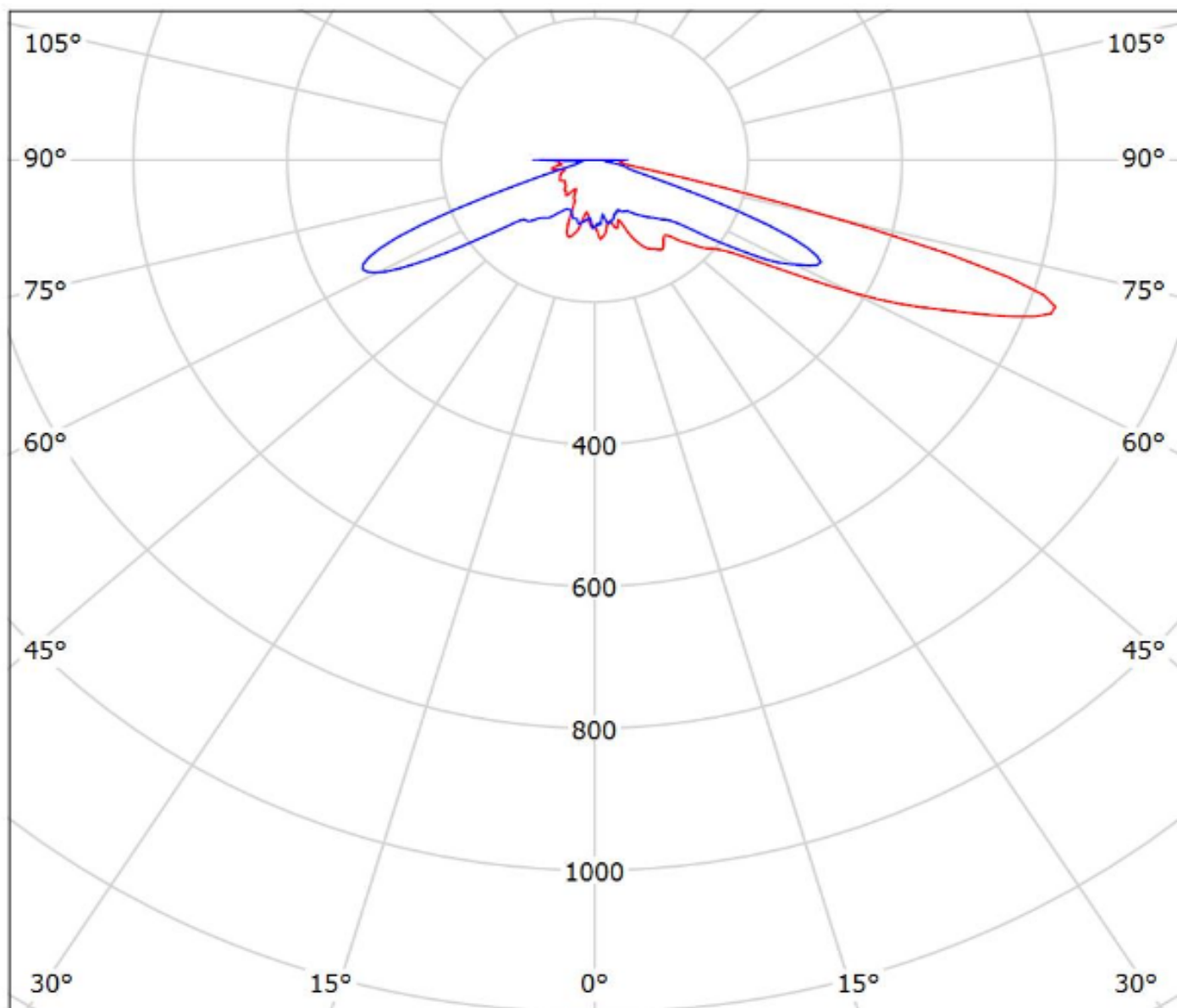

cd/klm

— C0 - C180 — C90 - C270

$\eta = 91\%$

Luminaire: Ledil Oy C15014\_STRADA-2X2-T4-B\_simulated\_NVSW219B  
Lamps: 1 x Nichia NVSW219B

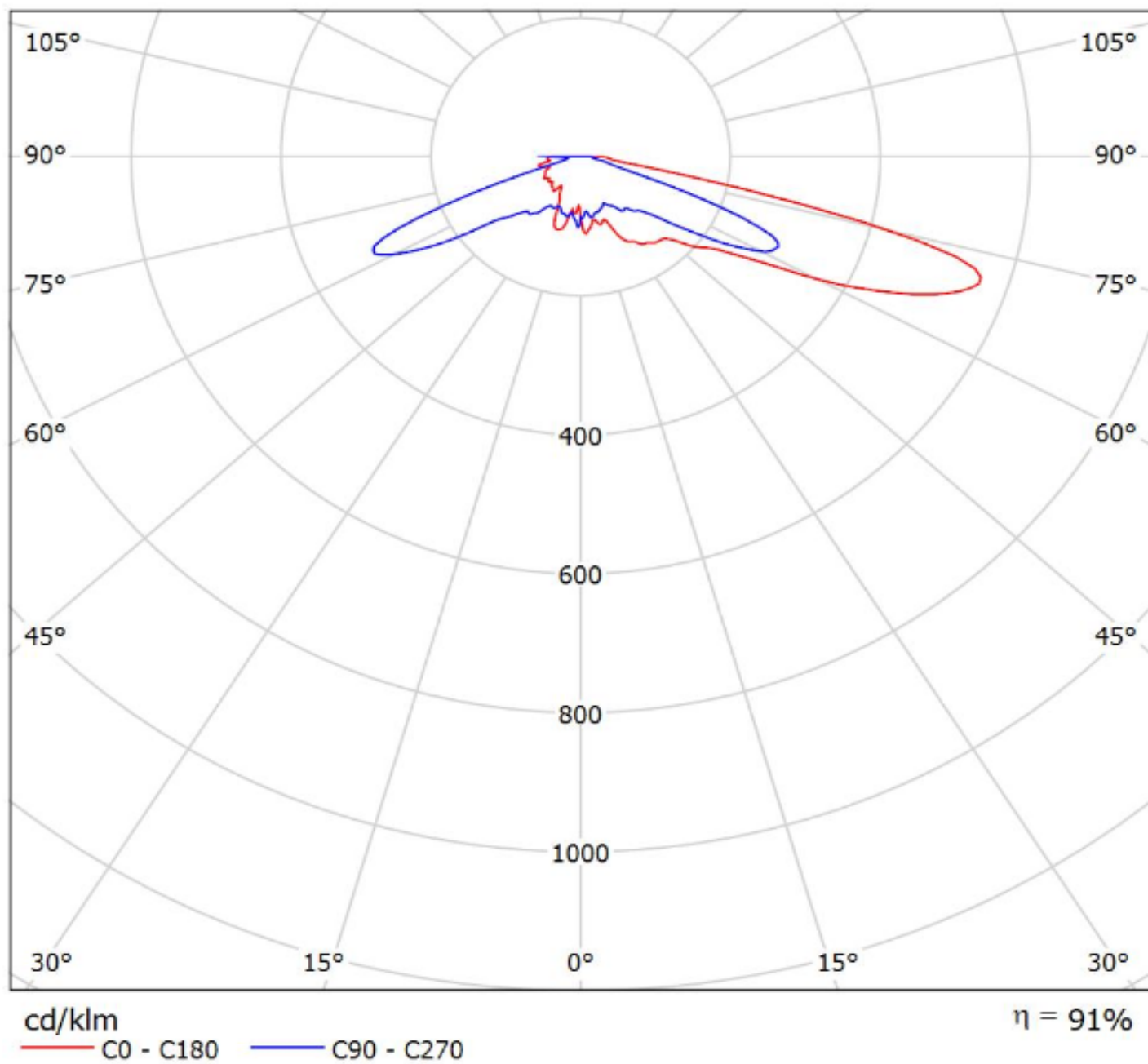

Luminaire: Ledil C15014\_STRADA-2X2-T4-B\_(NVSW319AE)  
Lamps: 1 x Nichia\_NVSW319AE\_(sm405D440f2L2R70)

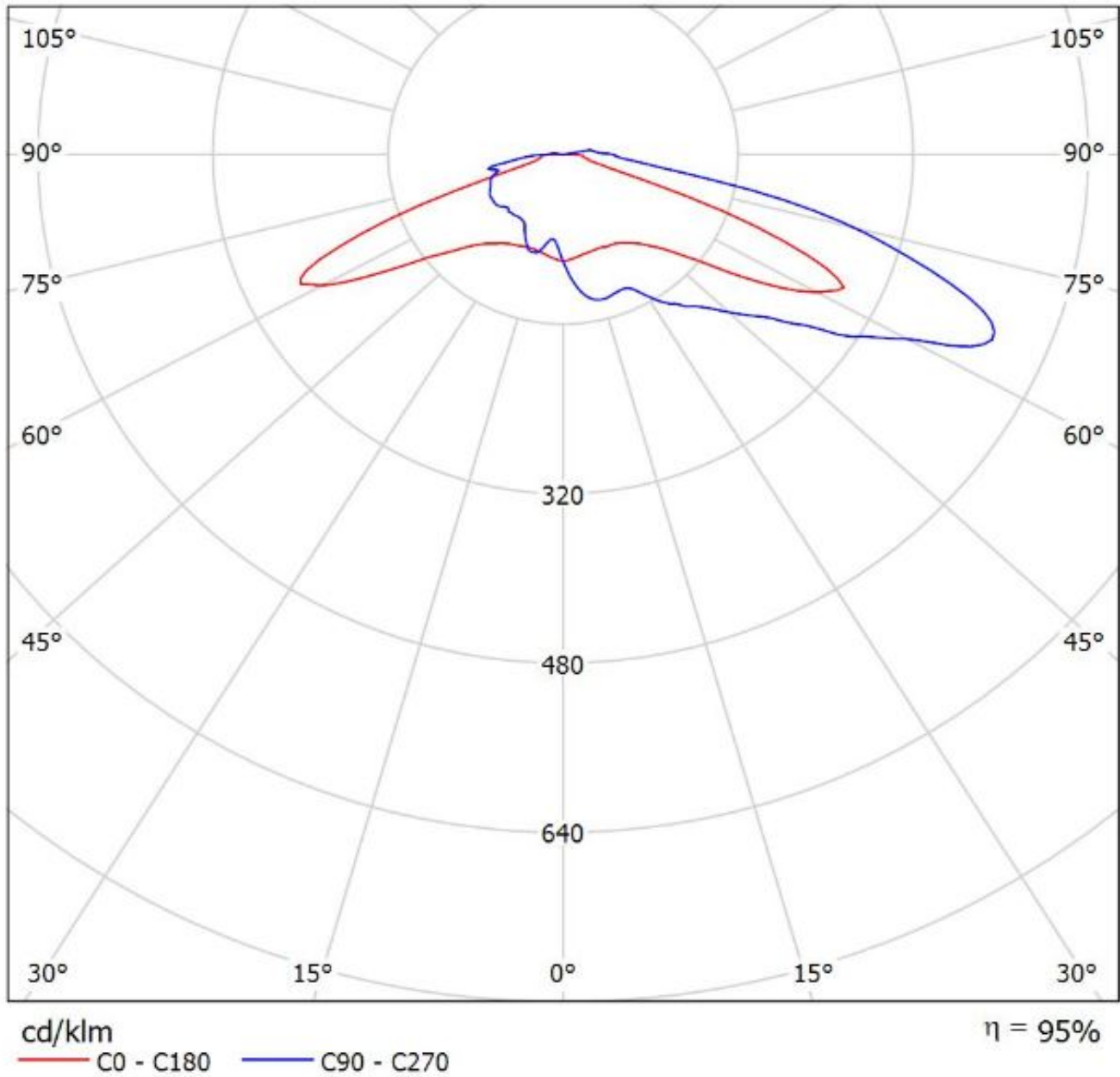

Luminaire: LEDiL Oy C15014\_STRADA-2X2-T4-B\_(E21A)  
Lamps: 1 x Nichia\_E21A\_452.248lm@250mA\_2.805W\_I=0.250A

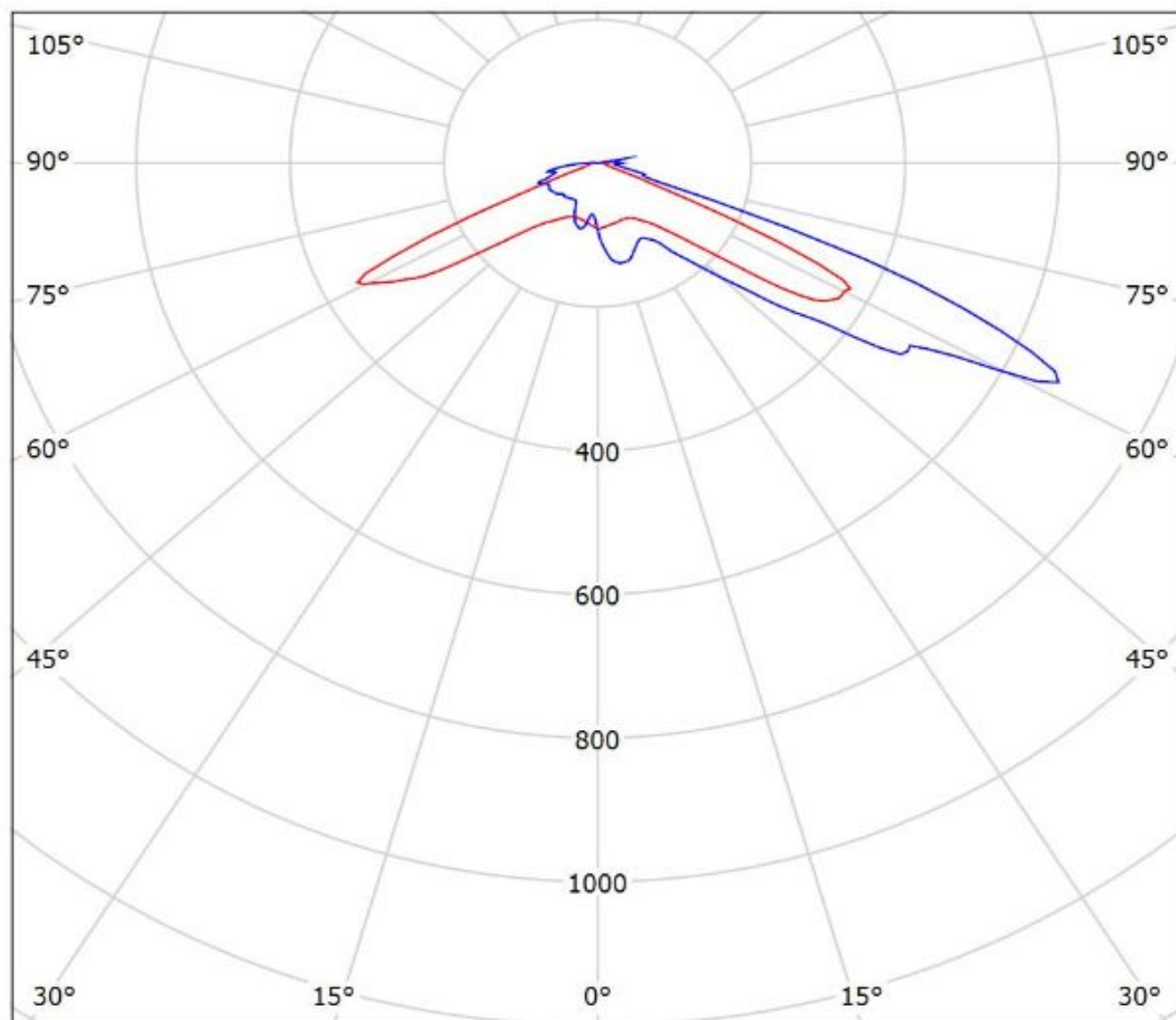

cd/klm  
— C0 - C180 — C90 - C270

$\eta = 95\%$

Luminaire: Ledil Oy C15014\_STRADA-2X2-T4-B\_(NWSx229A)\_SIMULATED  
Lamps: 1 x Nichi NWSW229A

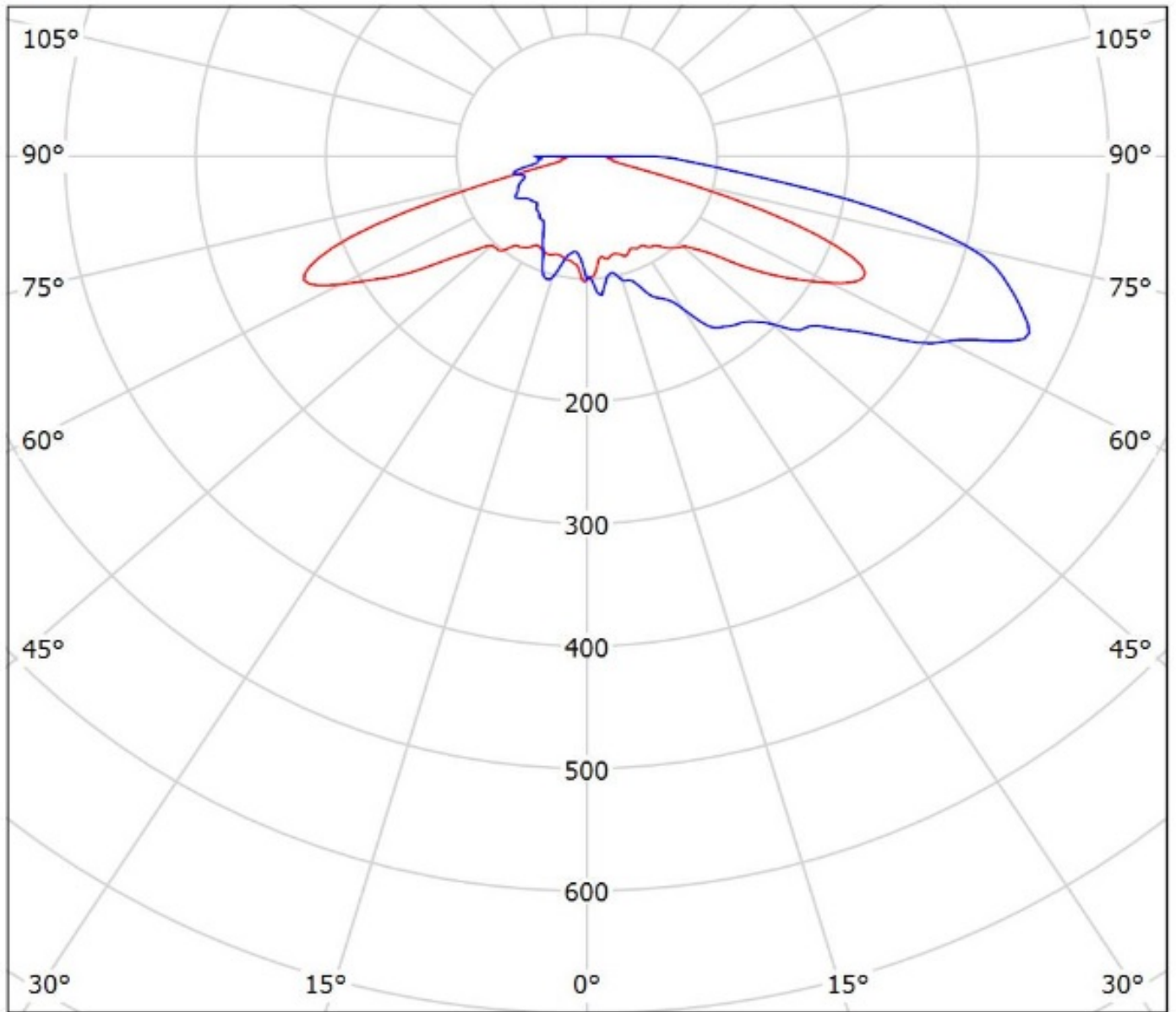

cd/klm

— C0 - C180 — C90 - C270

$\eta = 87\%$



Luminaire: Ledil Oy C15014\_STRADA-2X2-T4-B\_simulated\_OslonSQG3  
Lamps: 1 x Osram Oslon SQ G3

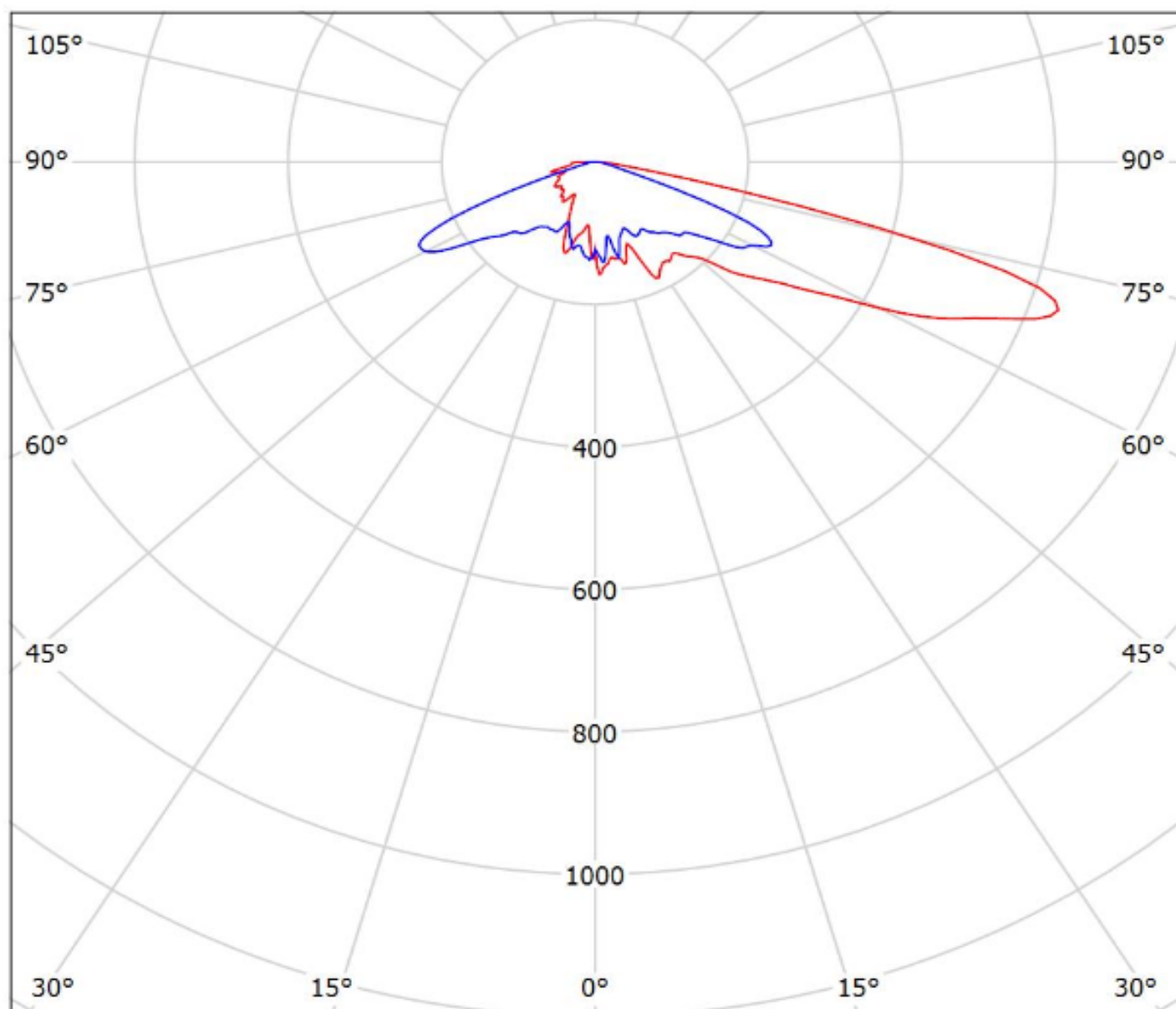

cd/klm

— C0 - C180 — C90 - C270

$\eta = 92\%$

Luminaire: Ledil Oy C15014\_STRADA-2X2-T4-B\_simulated\_OsISQPC  
Lamps: 1 x Osram Oslon S $\bar{Q}$  PC

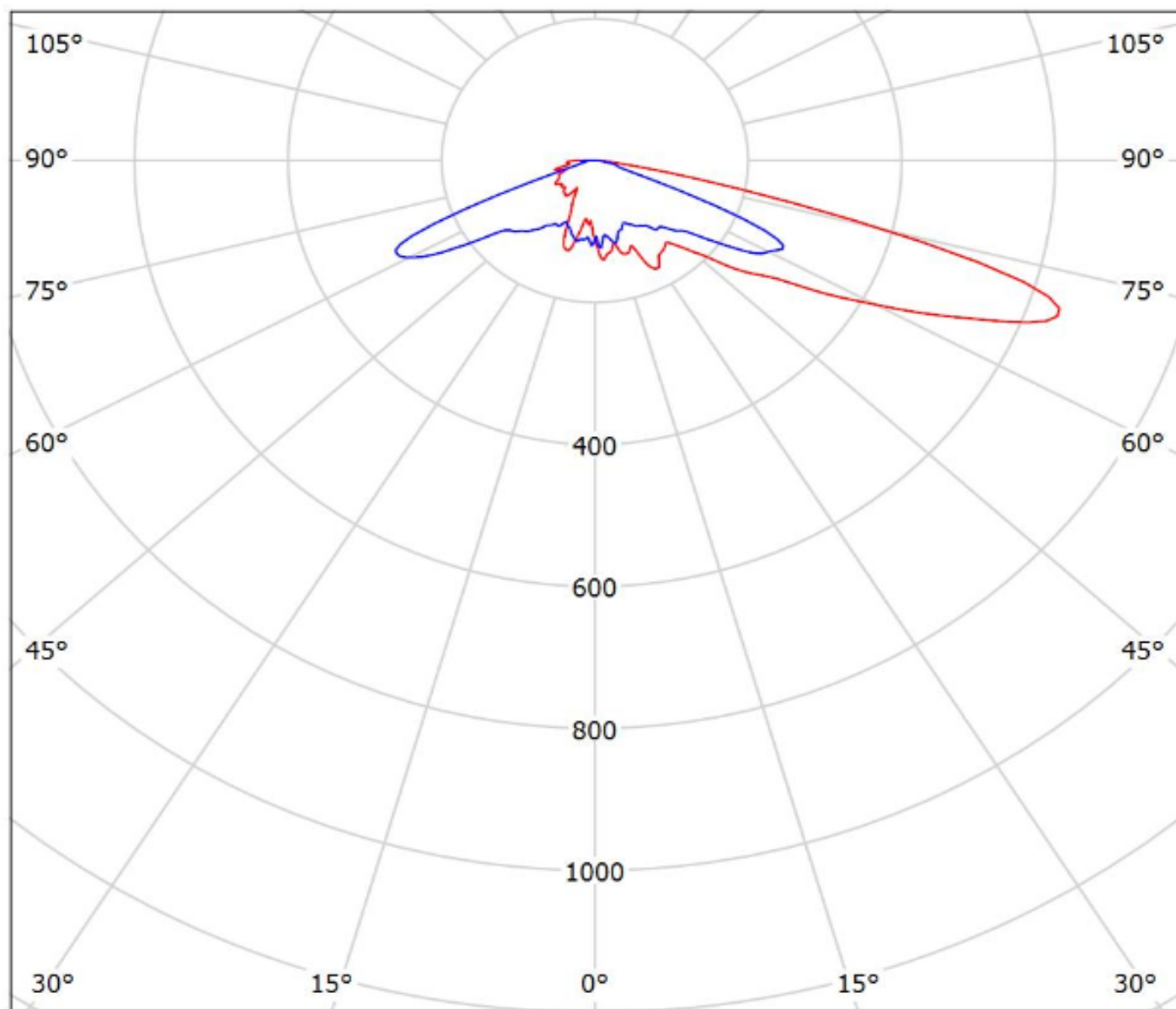

cd/klm

— C0 - C180 — C90 - C270

$\eta = 92\%$

Luminaire: Ledil Oy C15014\_STRADA-2X2-T4-B\_simulated\_DurisS8  
Lamps: 1 x Osram Duris S8

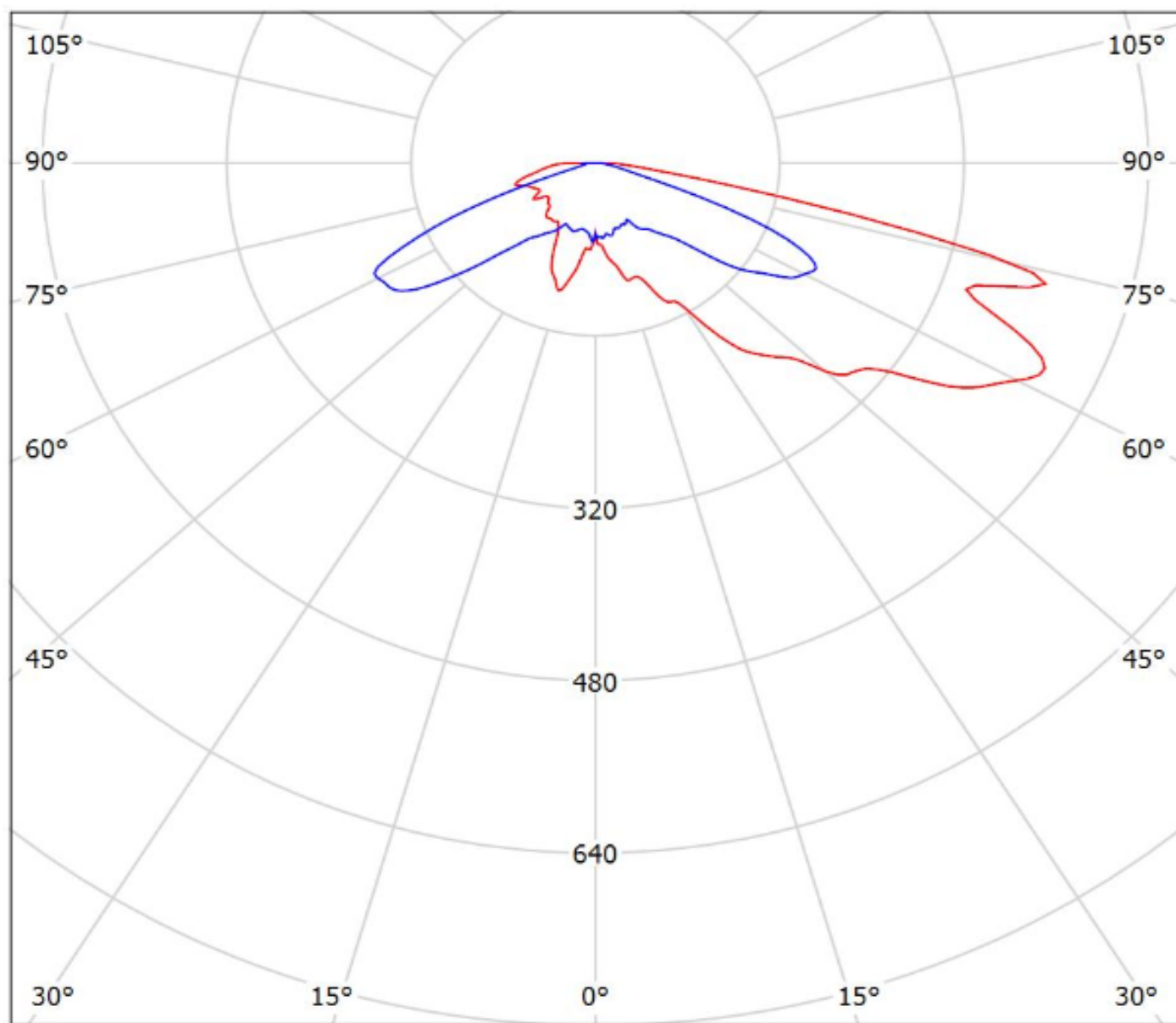

cd/klm

— C0 - C180    — C90 - C270

$\eta = 92\%$

Luminaire: LEDiL Oy C15014\_STRADA-2X2-T4-B\_(LH351D)  
Lamps: 1 x Samsung\_LH351D\_524.264lm@250mA\_P=2.7523W\_I=0.250A

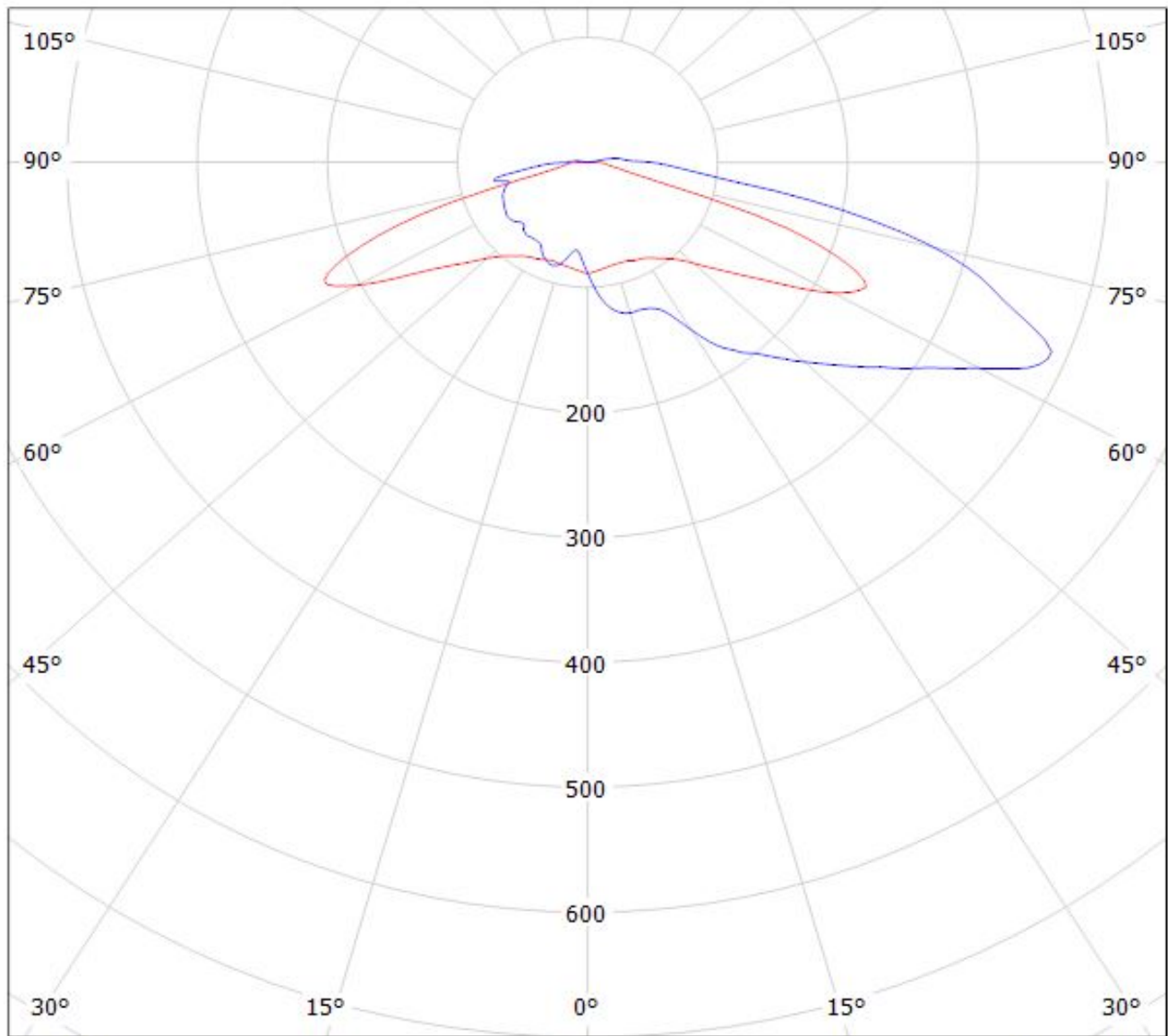

cd/klm

— C0 - C180

— C90 - C270

$\eta = 92\%$

Luminaire: Ledil C15014\_STRADA-2X2-T4-B\_(LH351C)

Lamps: 1 x Samsung\_LH351C\_518.223lm@250mA\_P=2.85225W\_I=0.25A

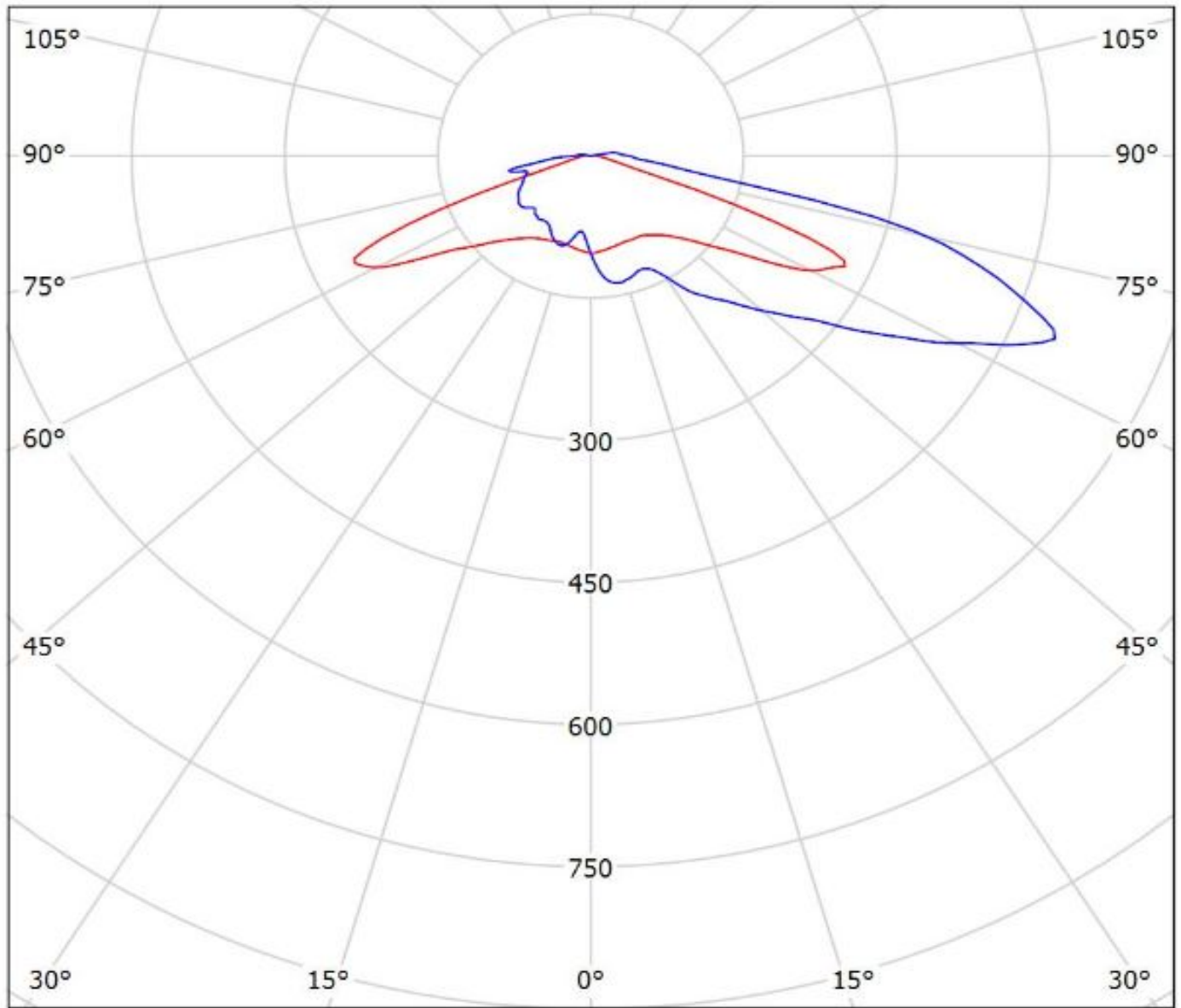

cd/klm

— C0 - C180

— C90 - C270

$\eta = 96\%$

Luminaire: Ledil C15014\_STRADA-2X2-T4-B\_(LH508A)

Lamps: 1 x Samsung\_LH508A\_2x2\_2060.04lm@160mA\_CCT=5000K\_CRI=80\_P=15.5405W\_I=0.16A

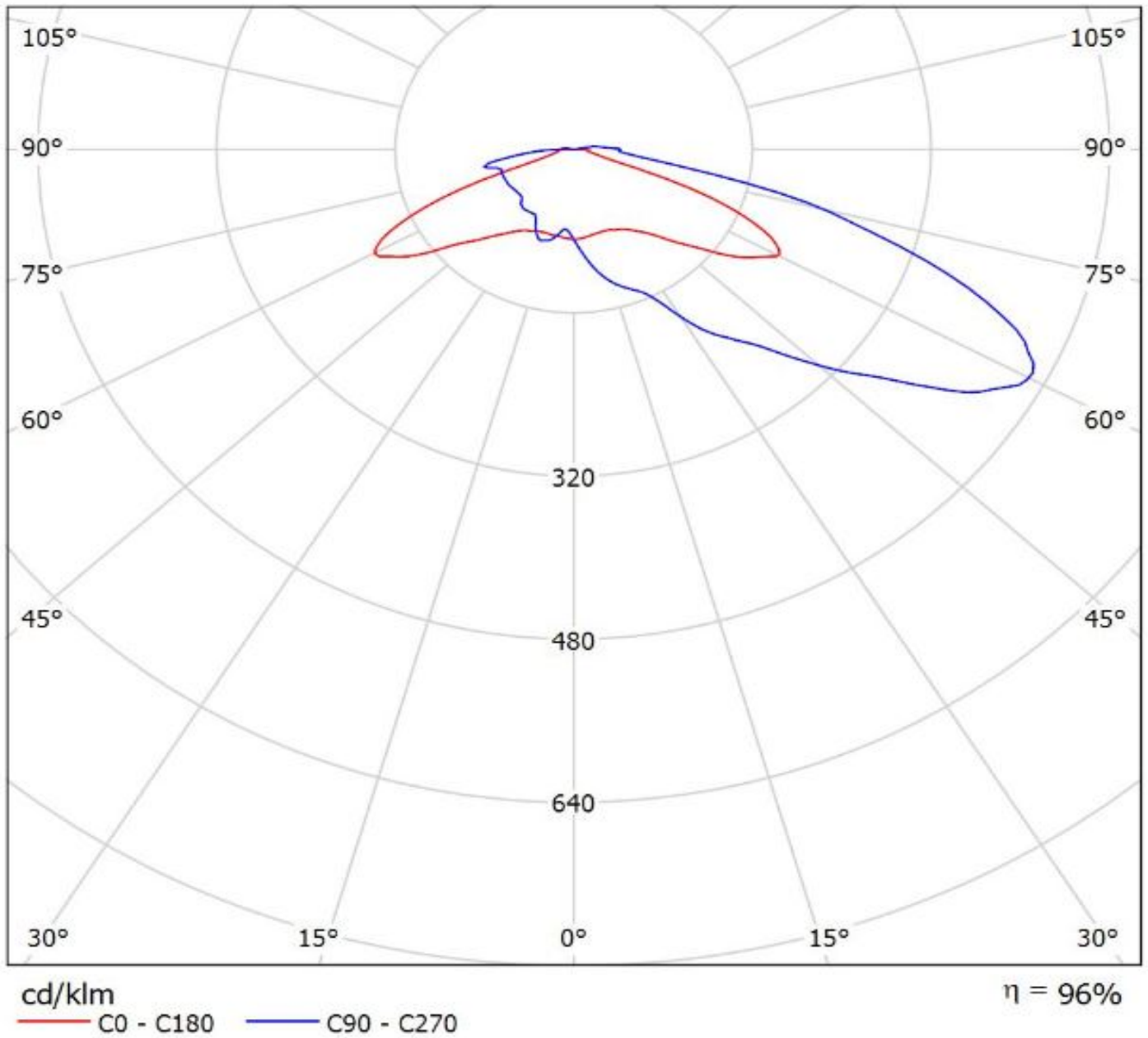

Luminaire: LEDiL Oy C15014\_STRADA-2X2-T4-B\_(Tridonic\_Module\_RLE\_G1)  
Lamps: 1 x Tridonic\_Module\_RLE\_G1\_4594.42lm@700mA\_P=32.1515W\_I=0.700A

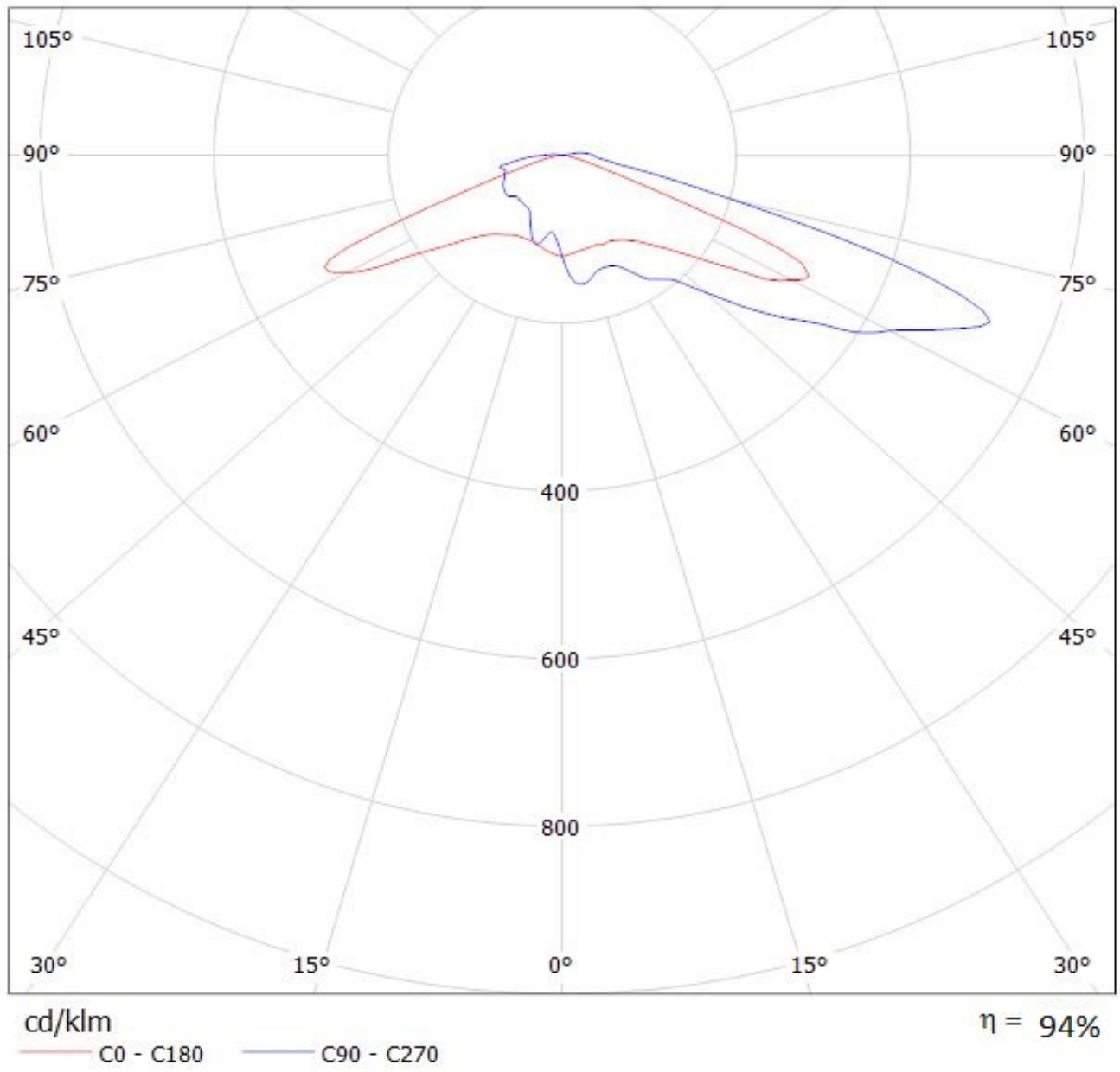

Luminaire: LEDiL Oy C15014\_STRADA-2X2-T4-B\_(Tridonic\_Module\_RLE\_G1)  
Lamps: 1 x Tridonic\_Module\_RLE\_G1\_4594.42lm@700mA\_P=32.1515W\_I=0.700A

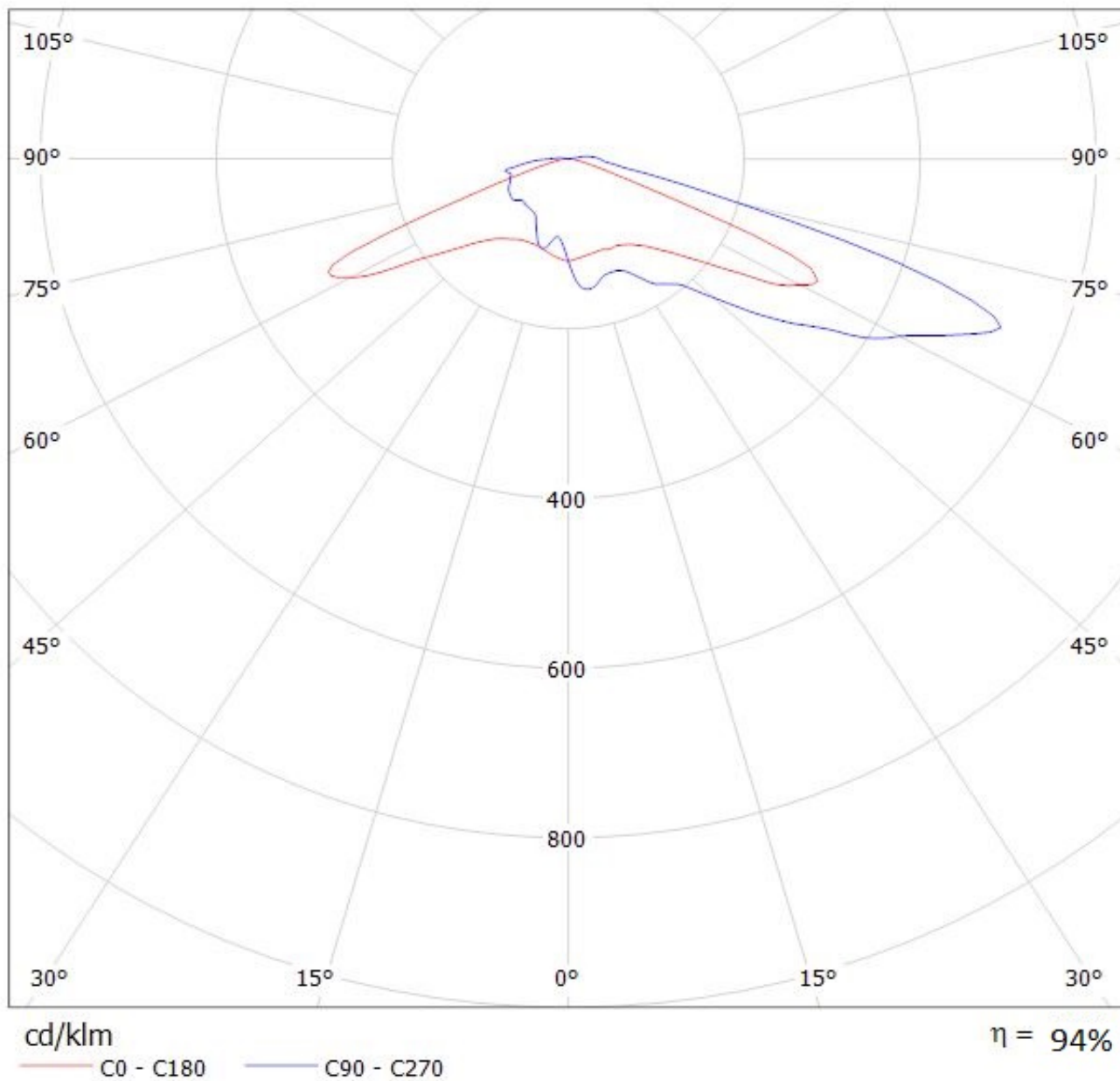



Luminaire: LEDiL Oy C15014\_STRADA-2X2-T4-B\_(Tridonic\_Module\_RLE\_G1)  
Lamps: 1 x Tridonic\_Module\_RLE\_G1\_2288lm@700mA\_P=16W\_I=0.700A

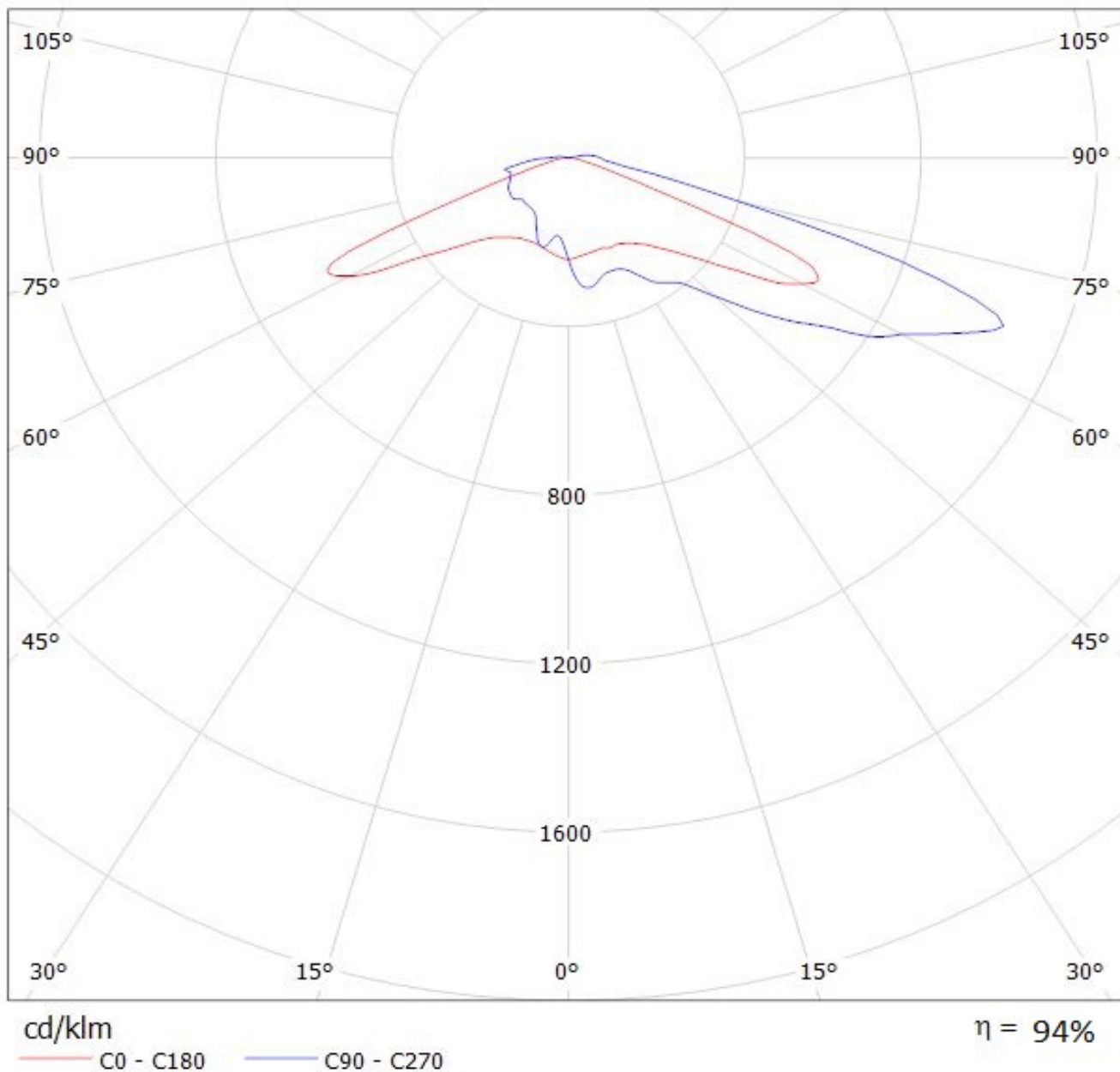

Luminaire: LEDiL Oy C15014\_STRADA-2X2-T4-B\_(Tridonic\_Module\_RLE\_G1)  
Lamps: 1 x Tridonic\_Module\_RLE\_G1\_2288lm@700mA\_P=16W\_I=0.700A

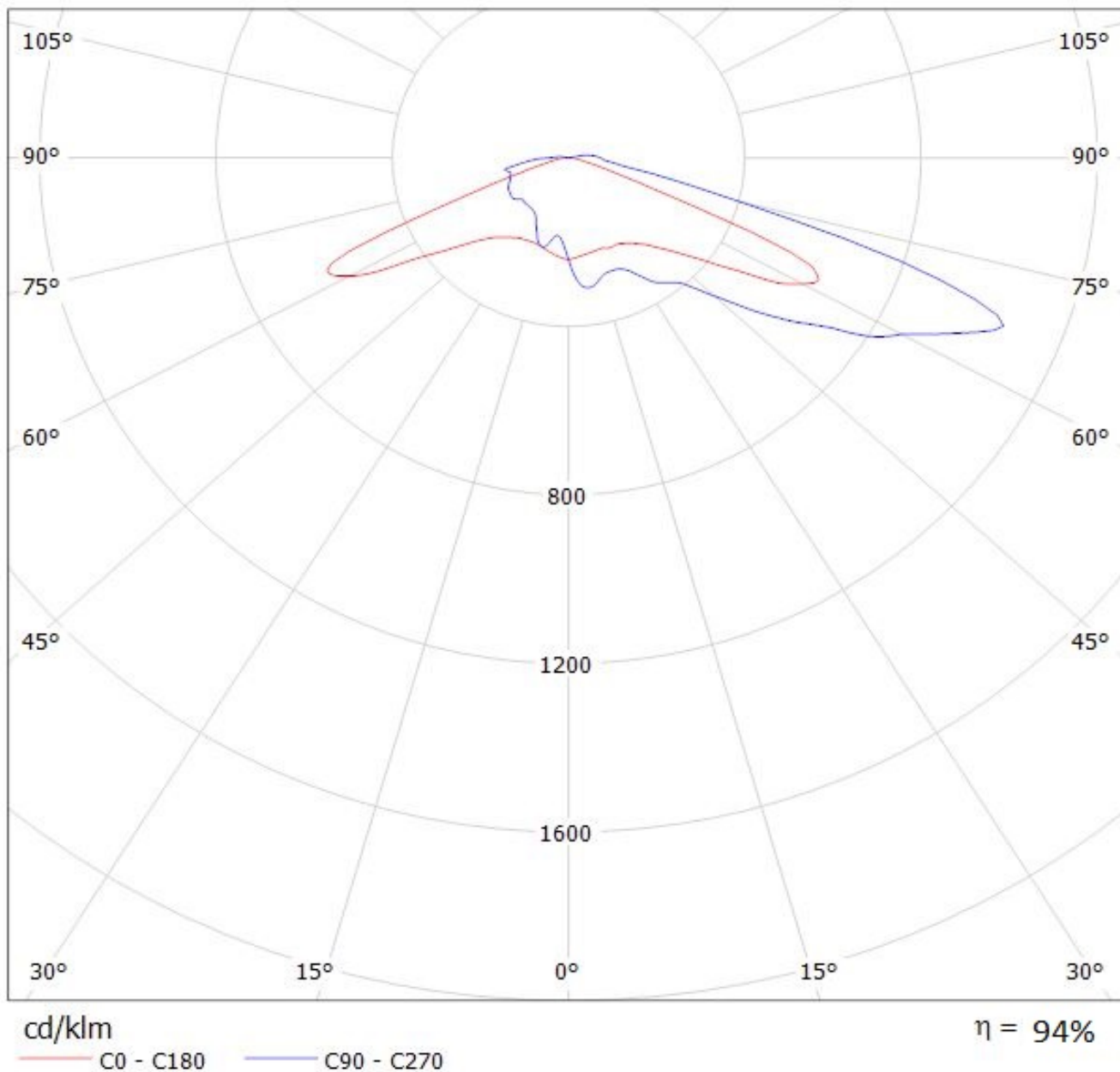

**NOTE: The typical divergence will be changed by different color, chip size and chip position tolerance. The typical total divergence is the full angle measured where the luminous intensity is half of the peak value.**