

DETAILS

Product Number	CA11016_TINA2-RS
Family	Tina
Type	Assembly
Color	black
Diameter	16,1 mm
Height	9,7 mm
Style	round
Optic Material	PMMA
Holder Material	
Fastening	tape
Status	production ready
ROHS Compliant	Yes
Date Updated	11/11/2016



OPTICAL PROPERTIES

LED	Viewing	Light	Effi-	cd/lm	Connector
	Angle	Beam	ciency		
XP-E	11 deg	Real spot	93 %	14.670	-
XP-G	15 deg	Real spot	93 %	9.000	-
XP-G2	15 deg	Real spot	91 %	10.000	-
XP-E2	11 deg	Real spot	89 %	16.600	-
H35C0 (LEMWA33)	16 deg	Real spot	91 %	8.000	-
H35B0 (LEMWA32)	14 deg	Real spot	91 %	11.000	-
H35C1 (LEMWA33)	16 deg	Real spot	88 %	8.800	-
Fortimo FastFlex LED board 2x8/757 DS	13 deg	Real spot	86 %	9.400	-
Z5	sim: 12	Real spot	-	-	-

D

C

B

A

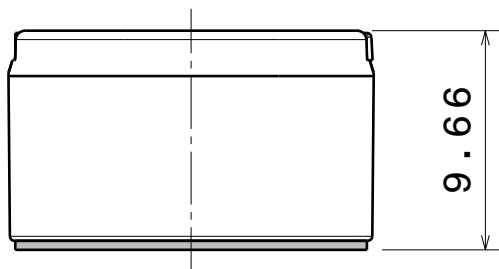

Bottom view
Scale: 3:1

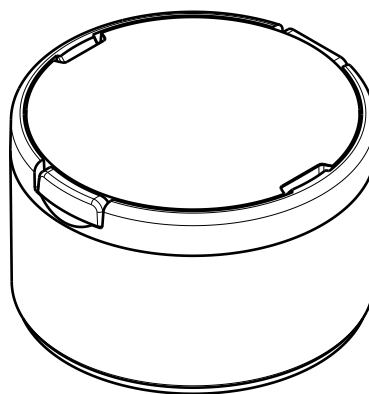

Isometric view
Scale: 3:1

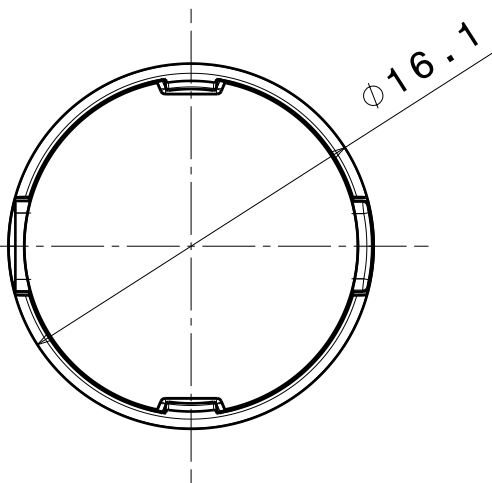

Front view
Scale: 3:1

PU foam tape 0.4mm

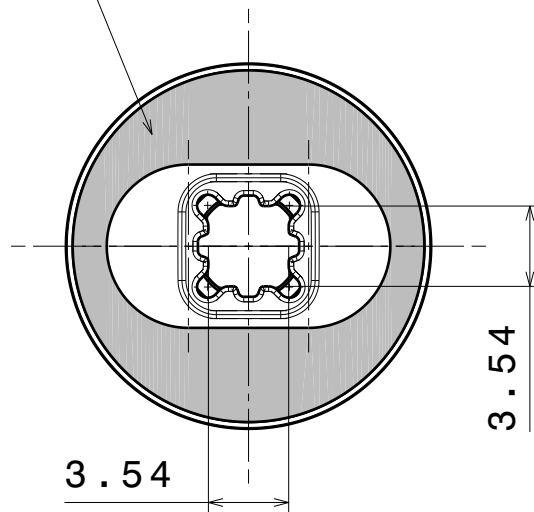

Rear view
Scale: 3:1

INDEX	PART NO	DESCRIPTION	MATERIAL	COLOUR
1	-	TINA2-lens	PMMA	
2	C11418	TINA2-XP-HLD-TAPE-BLK	PC	black

Tolerances if not otherwise shown
According to DIN ISO 2768-1
Linear measures:
Up to 30mm class M, otherwise class C.
According to DIN ISO 2768-2
Form and position: class L

LEDiL

Ledil Oy
Salorankatu 10
FIN 24240 SALO
Finland

THIRD ANGLE PROJECTION:



DRAWING TITLE

TINA2-XP-series assembly

This drawing is the property
of LEDiL Oy. It may not be
reproduced, copied or
communicated without a written
agreement with LEDiL Oy.

SIZE PART NUMBER

A4

-

SCALE 3:1 WEIGHT 1,3 g SHEET 1/1

D

A

Ledil Oy CA11017_Tina2-XP-M-black Cree XP-E (white) 76lm @ 250mA LOR is 91% / LDC (Linear)

Luminaire: Ledil Oy CA11017_Tina2-XP-M-black Cree XP-E (white) 76lm @ 250mA LOR is 91%
Lamps: 1 x Cree XP-E (white) 76lm @ 250mA

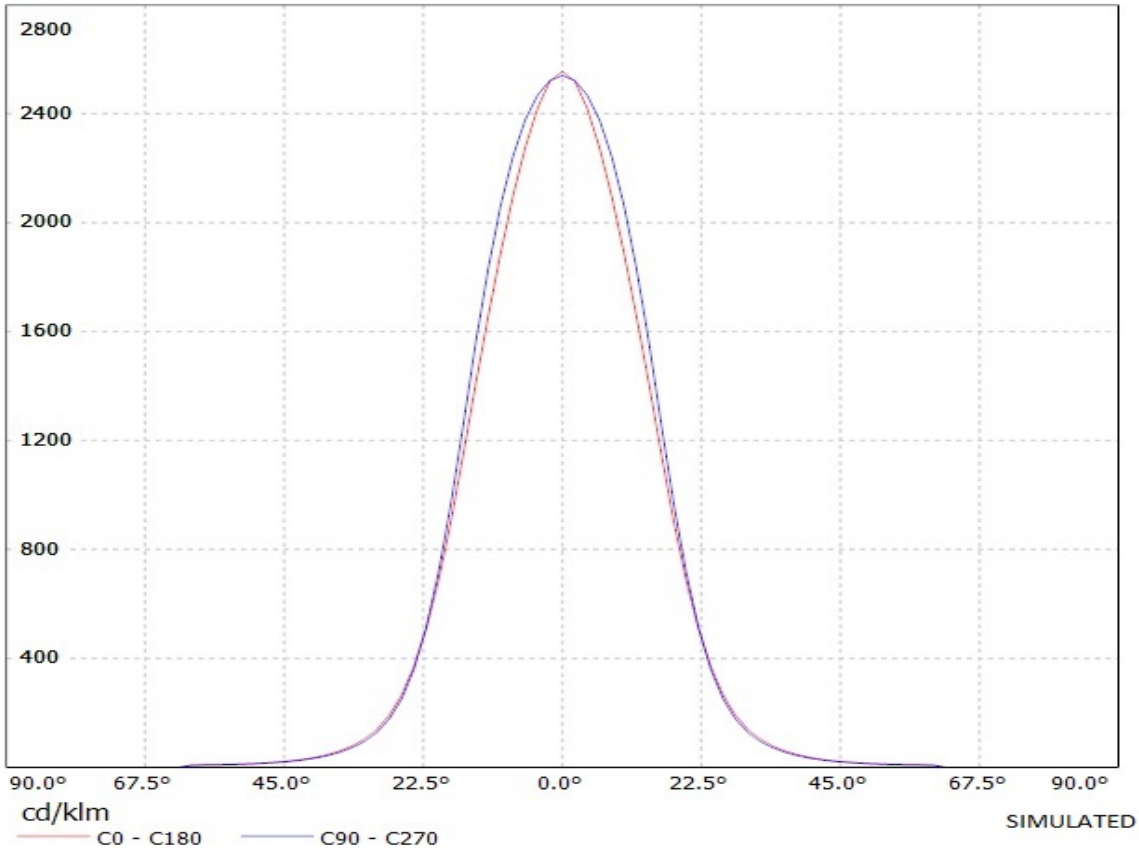

Ledil Oy CA11016_Tina2-XP-G-RS-black LOR=95% / LDC (Linear)

Luminaire: Ledil Oy CA11016_Tina2-XP-G-RS-black LOR=95%
Lamps: 1 x Cree XP-G 250mA 89lm

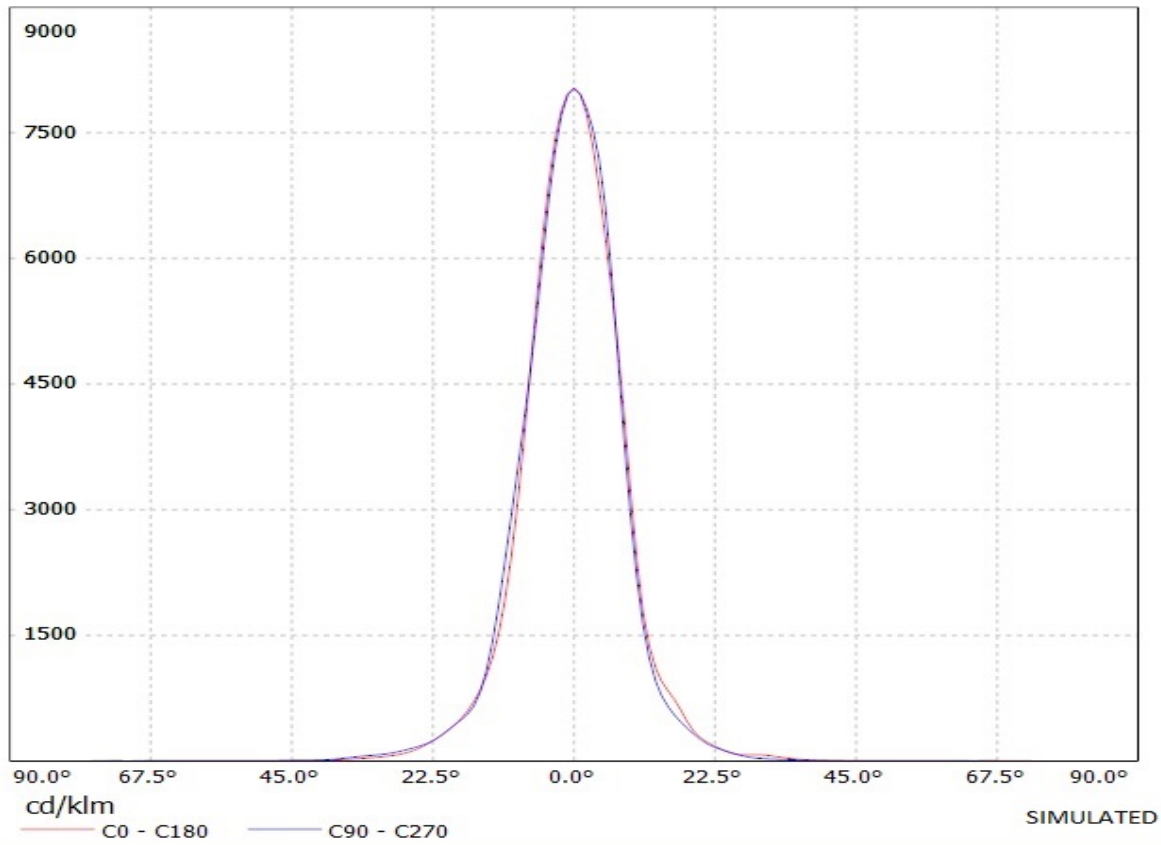

Valaisin: LEDIL OY CA11016_TINA2-RS_(XP-G2) Efficiency=91%
Lamput: 1 x Cree XP-G2 (109.1lm @ 250mA)

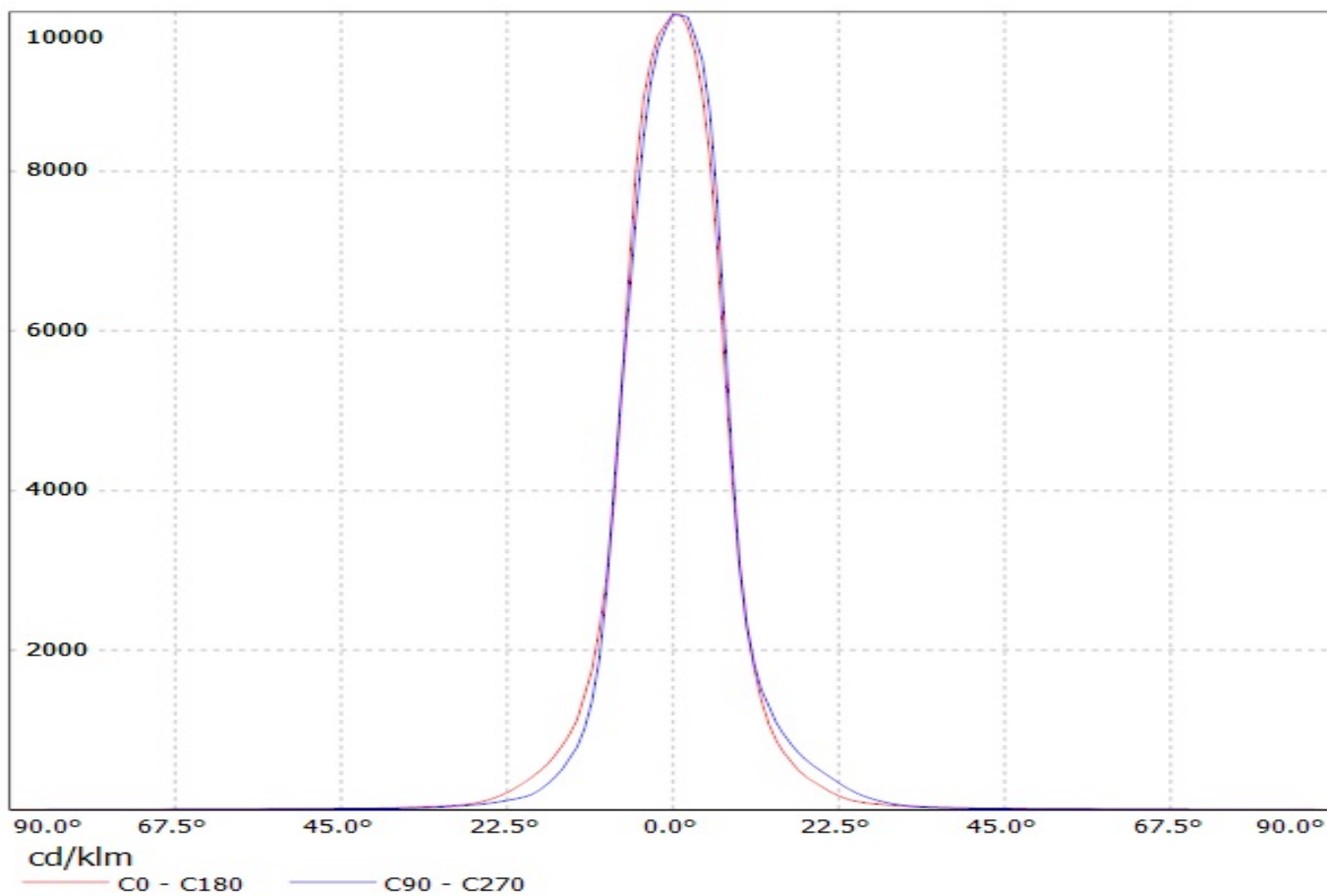

Luminaire: Ledil Oy CA11016_TINA2-RS (CREE XP-E2 92 lm @ 250 mA) Efficiency=89%
Lamps: 1 x CREE XP-E2 92 lm @ 250 mA

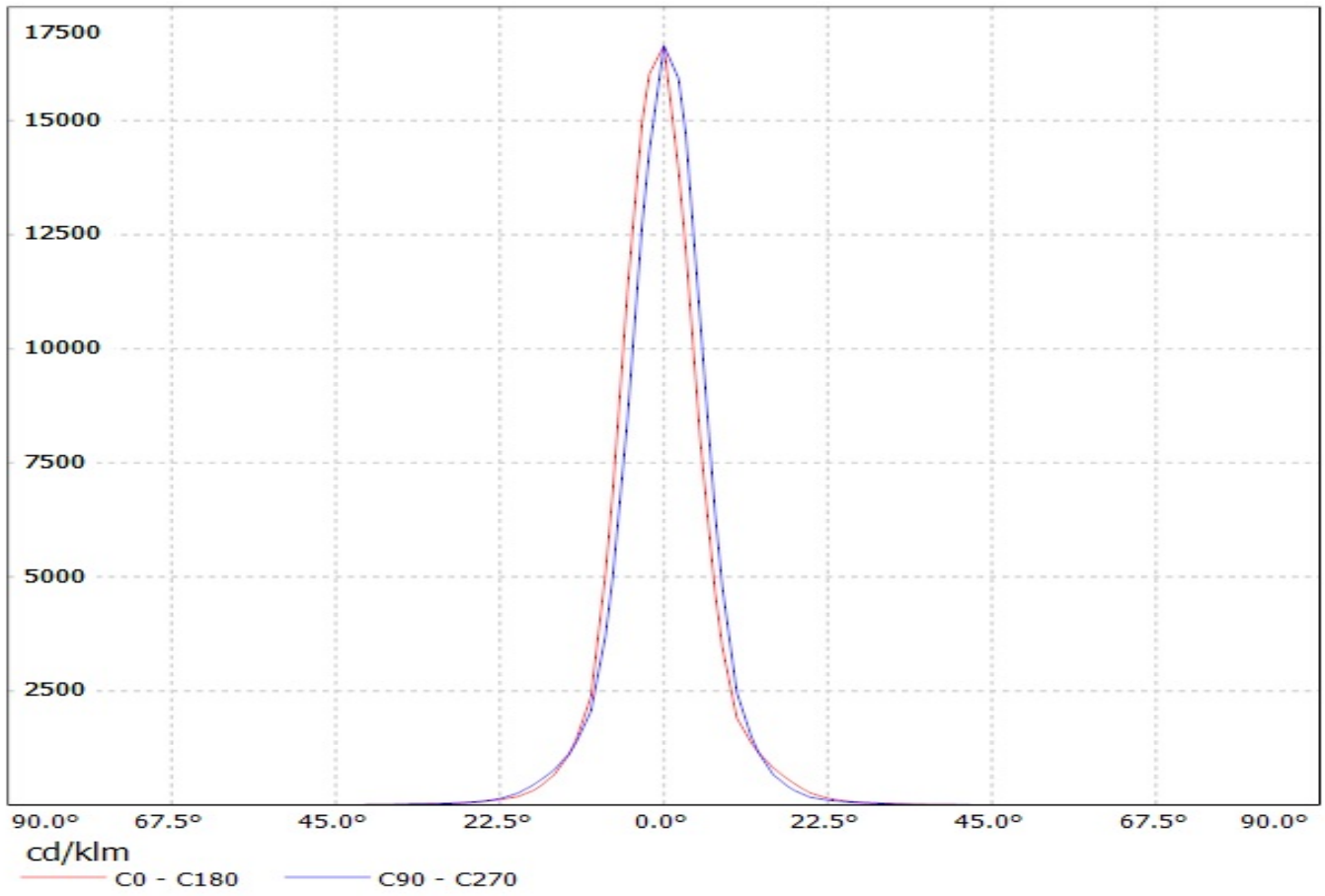

LEDiL Oy CA11016_TINA2-RS_(3535_Ceramic)_2 Eff.90.7% / LDC (Linear)

Luminaire: LEDiL Oy CA11016_TINA2-RS_(3535_Ceramic)_2 Eff.90.7%

Lamps: 1 x LG 3535 Ceramic (95lm@250mA)

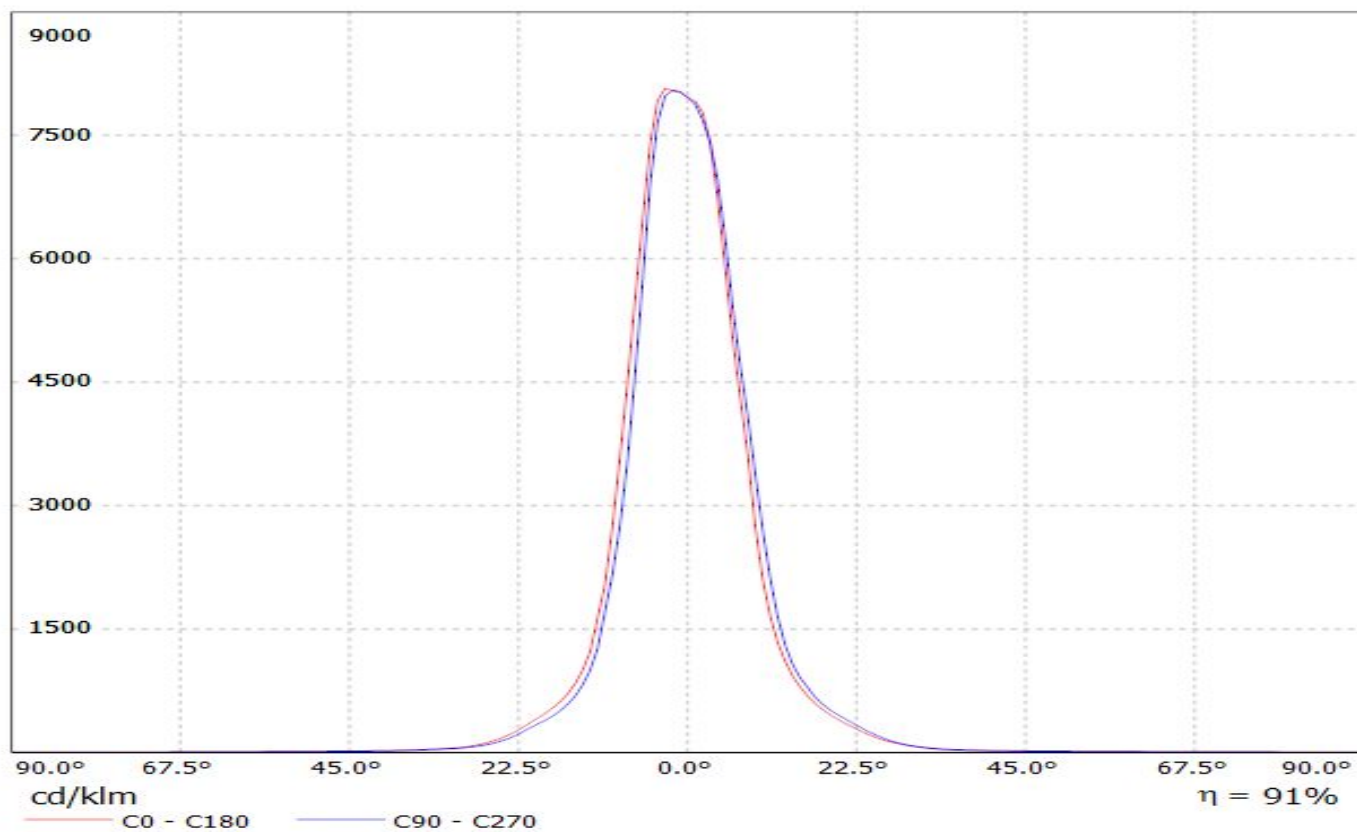

LEDiL Oy CA11016_TINA2_RS_(LG3535_2W) Eff.90.8% / LDC (Linear)

Luminaire: LEDiL Oy CA11016_TINA2_RS_(LG3535_2W) Eff.90.8%
Lamps: 1 x LG3535_2W (97.2479lm@250mA)

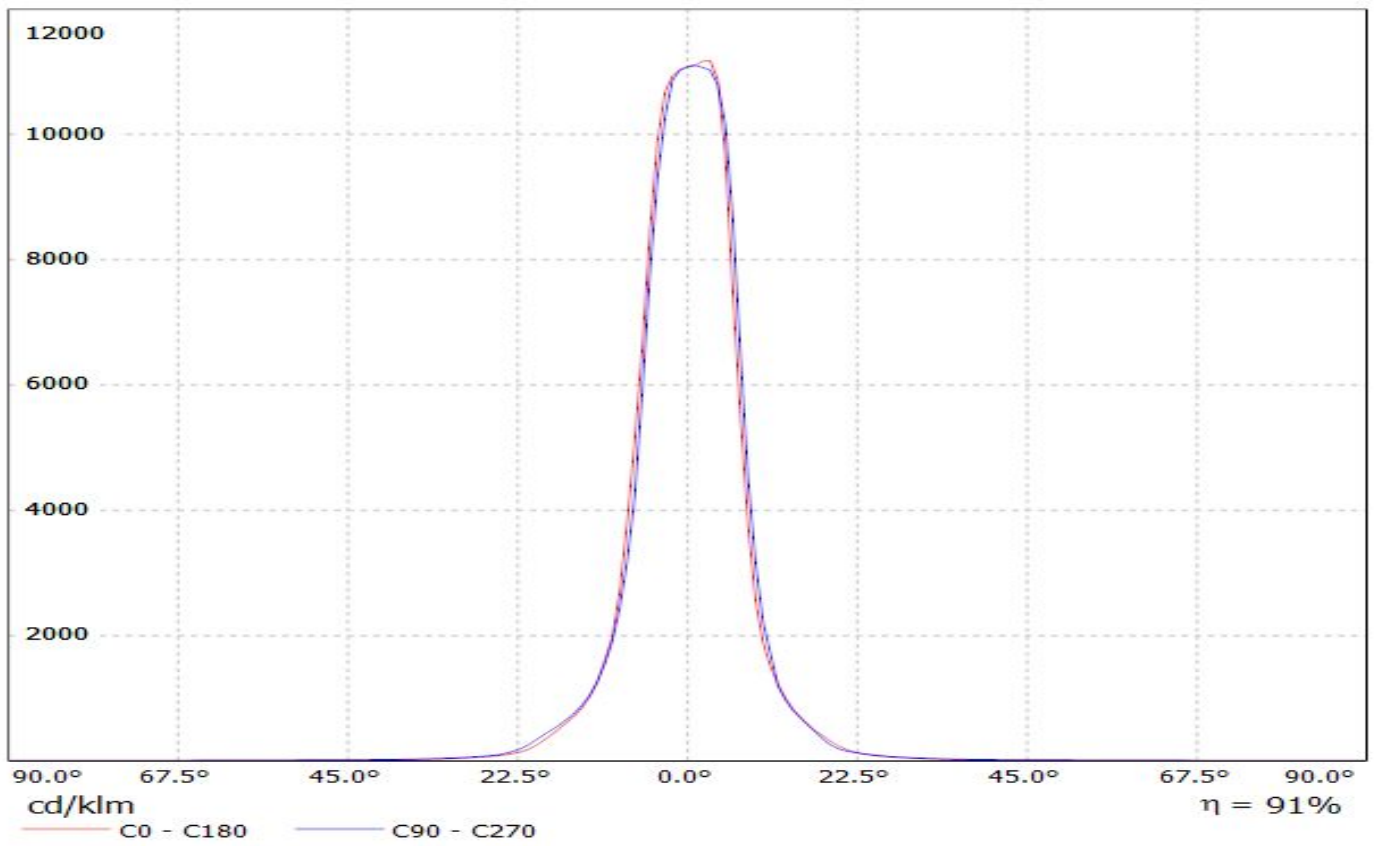

Luminaire: Ledil Oy CA11016_TINA2-RS_(3535_Ceramic_gen2) Efficiency=88%
Lamps: 1 x LG 3535 Ceramic gen2 (PKG5700K) 116lm @ 250mA CCT=6200K P=0.7W I=250mA

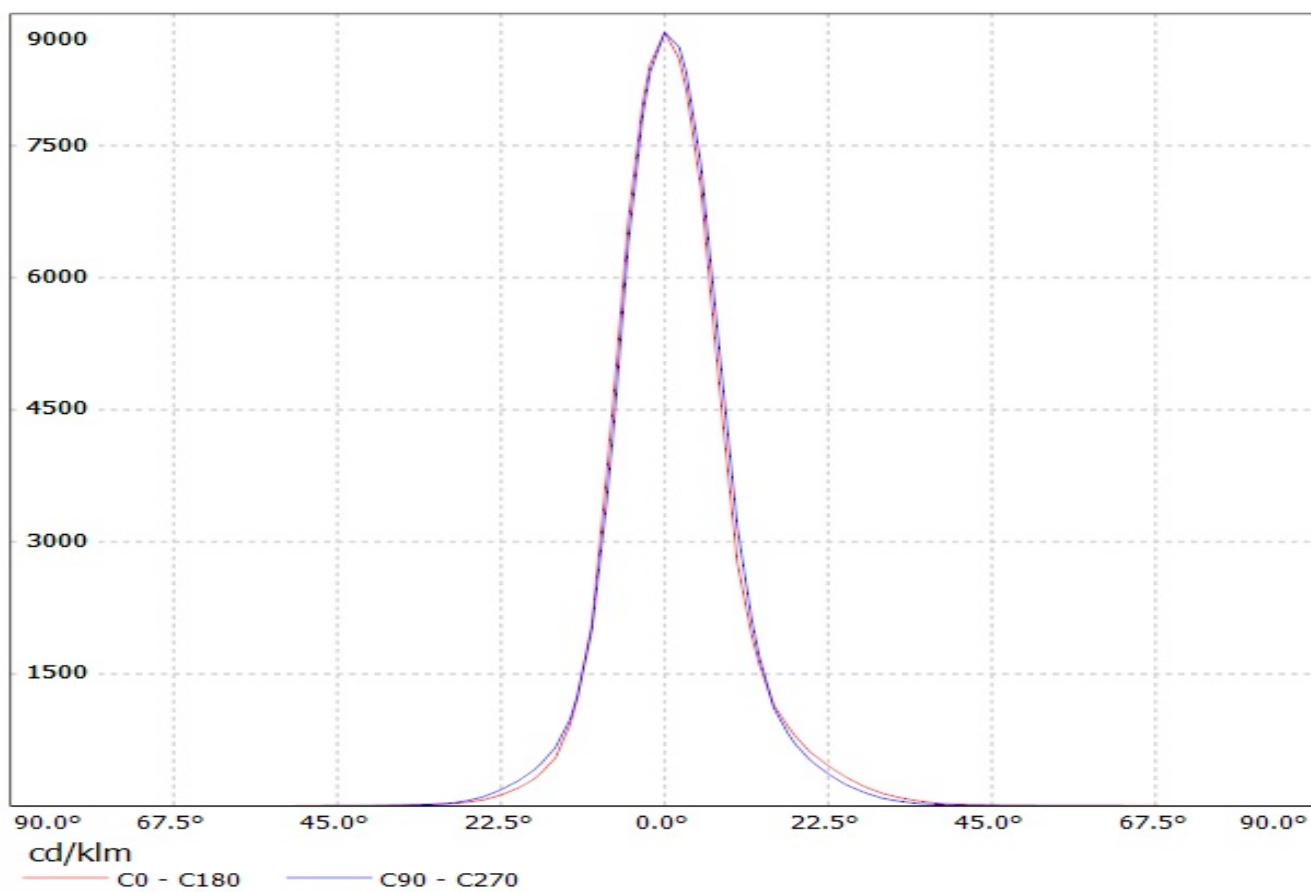

**Ledil CA11016_TINA2-RS_(Fortimo_FastFlex_LED_board 2x8-757_DS_G3) /
LDC (Linear)**

Luminaire: Ledil CA11016_TINA2-RS_(Fortimo_FastFlex_LED_board 2x8-757_DS_G3)
Lamps: 1 x Philips_Fortimo_FastFlex_LED_board 2x8/757_DS_G3_(XP-G2)
_3428.78lm@500mA_P=23.7W_I=0.5A

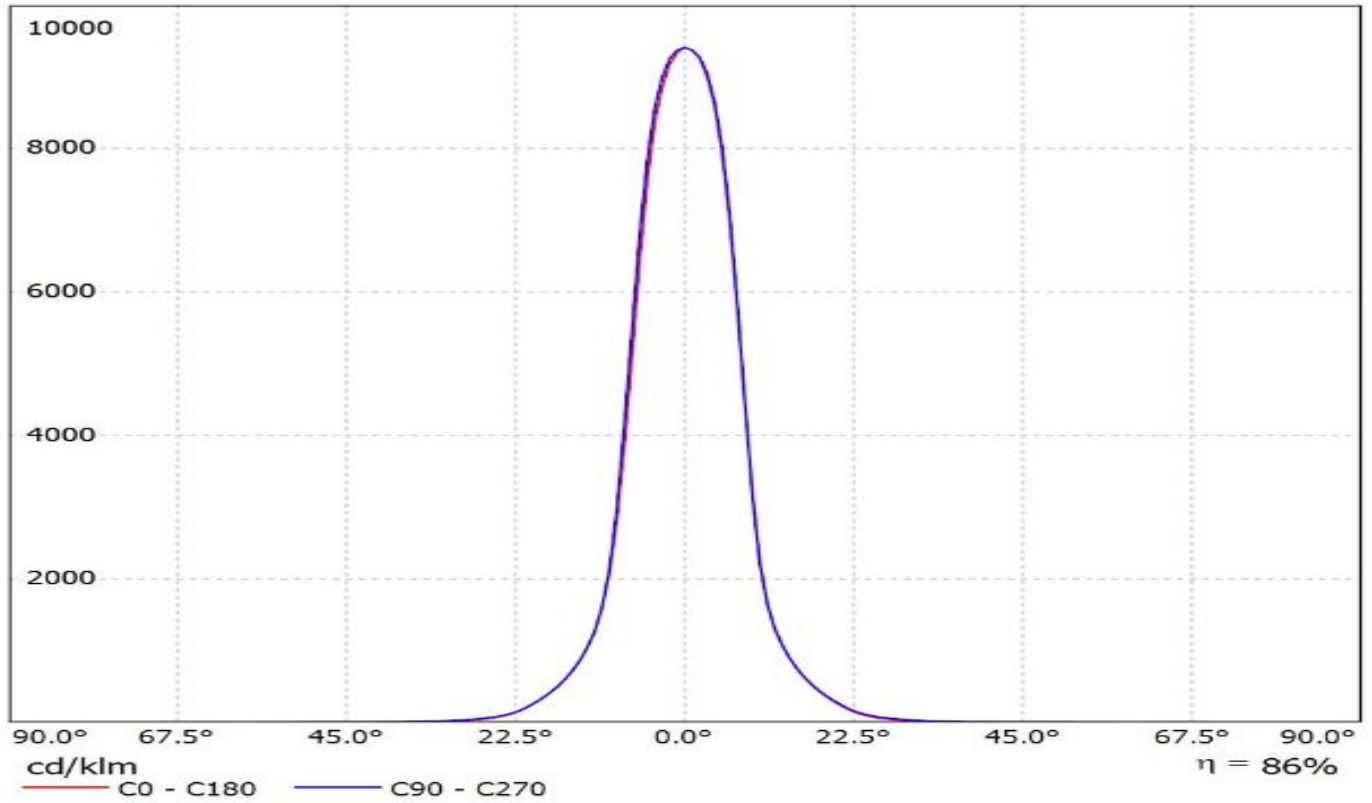

Ledil Oy CA11017_Tina2-XP-M-black Cree XP-E (white) 76lm @ 250mA LOR is 91% / LDC (Polar)

Luminaire: Ledil Oy CA11017_Tina2-XP-M-black Cree XP-E (white) 76lm @ 250mA LOR is 91%
Lamps: 1 x Cree XP-E (white) 76lm @ 250mA

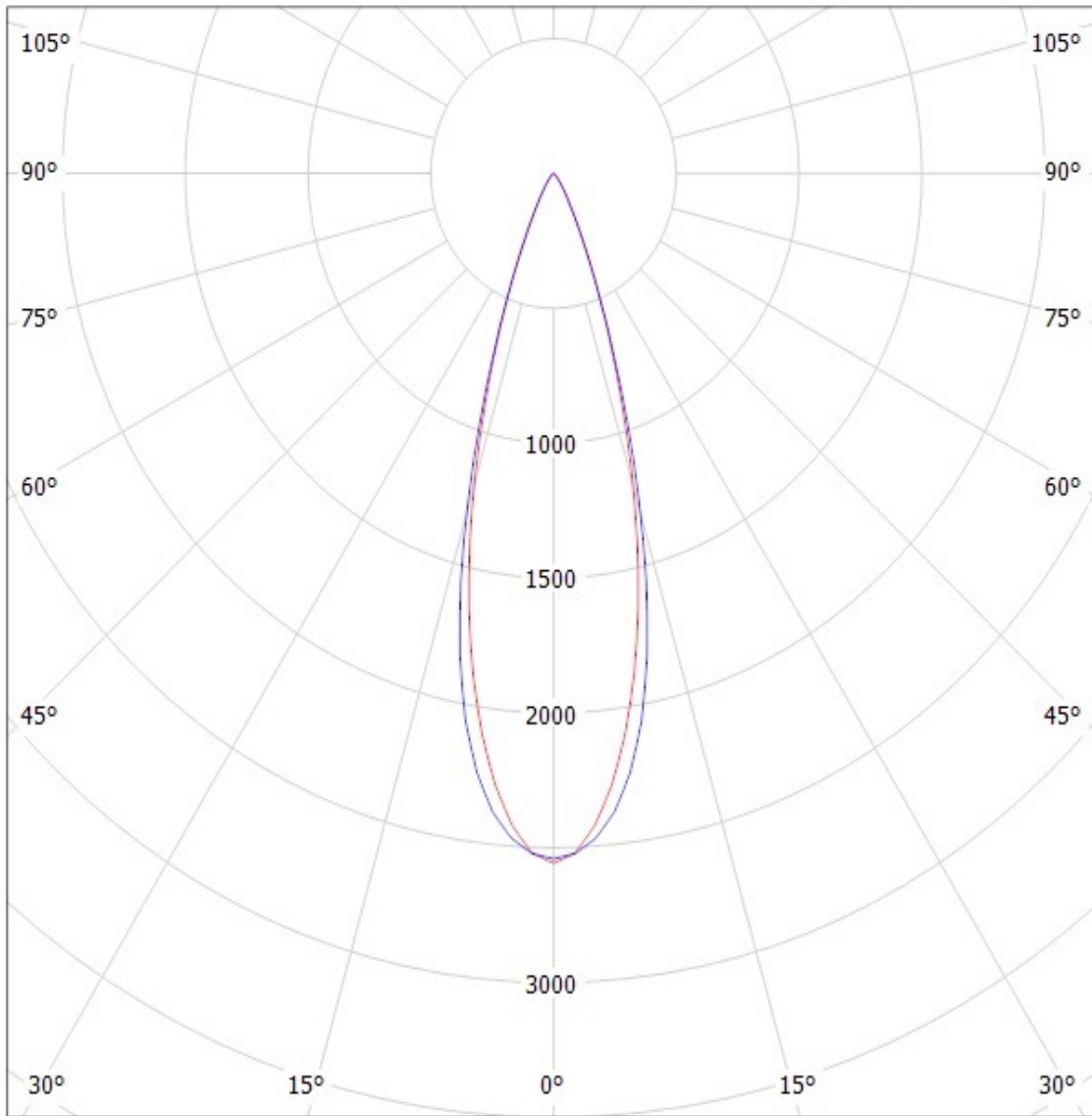

cd/klm

— C0 - C180 — C90 - C270

SIMULATED

Ledil Oy CA11016_Tina2-XP-G-RS-black LOR=95% / LDC (Polar)

Luminaire: Ledil Oy CA11016_Tina2-XP-G-RS-black LOR=95%
Lamps: 1 x Cree XP-G 250mA 89lm

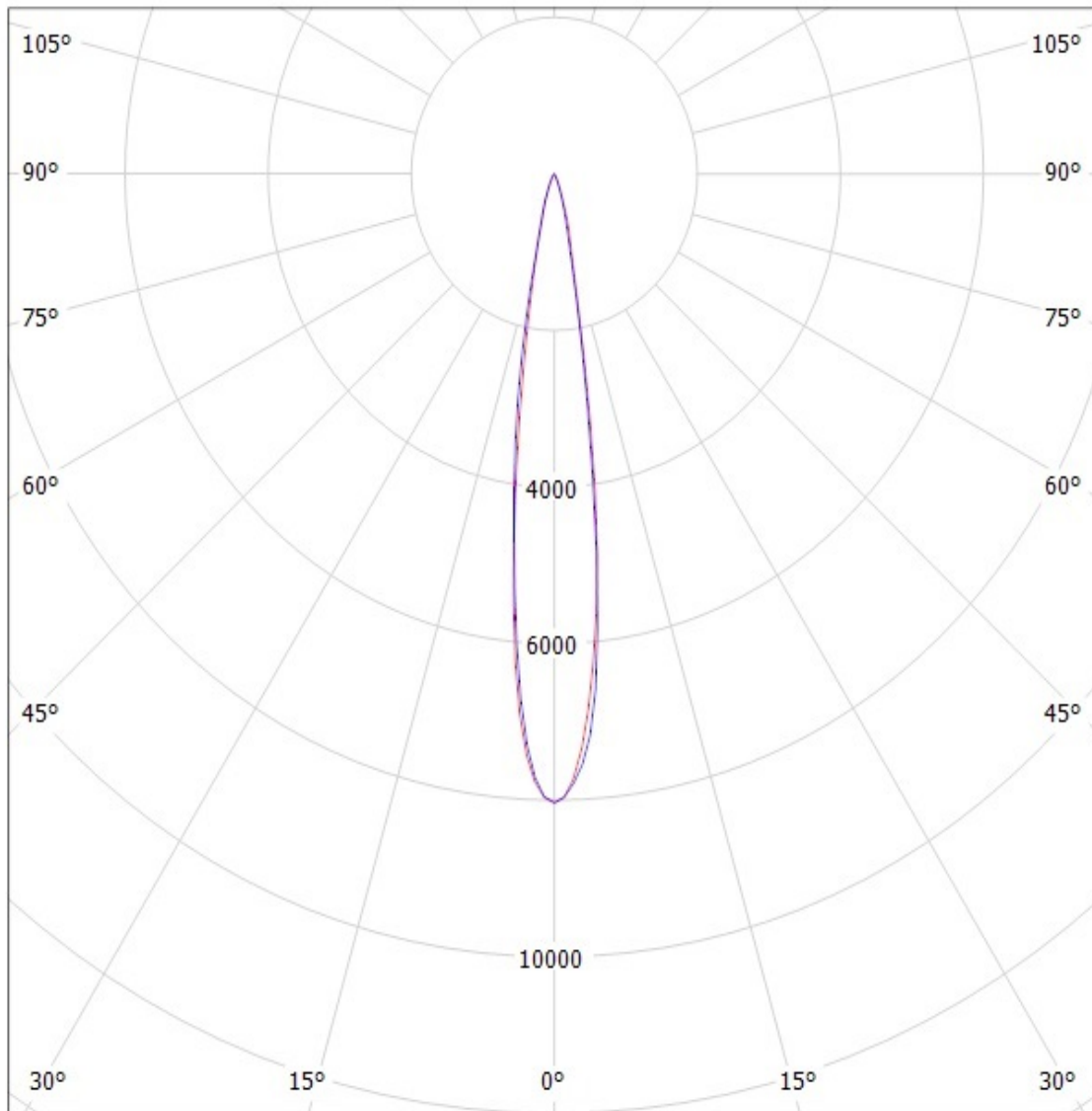

cd/klm

— C0 - C180 — C90 - C270

SIMULATED

Valaisin: LEDIL OY CA11016_TINA2-RS_(XP-G2) Efficiency=91%
Lamput: 1 x Cree XP-G2 (109.1lm @ 250mA)

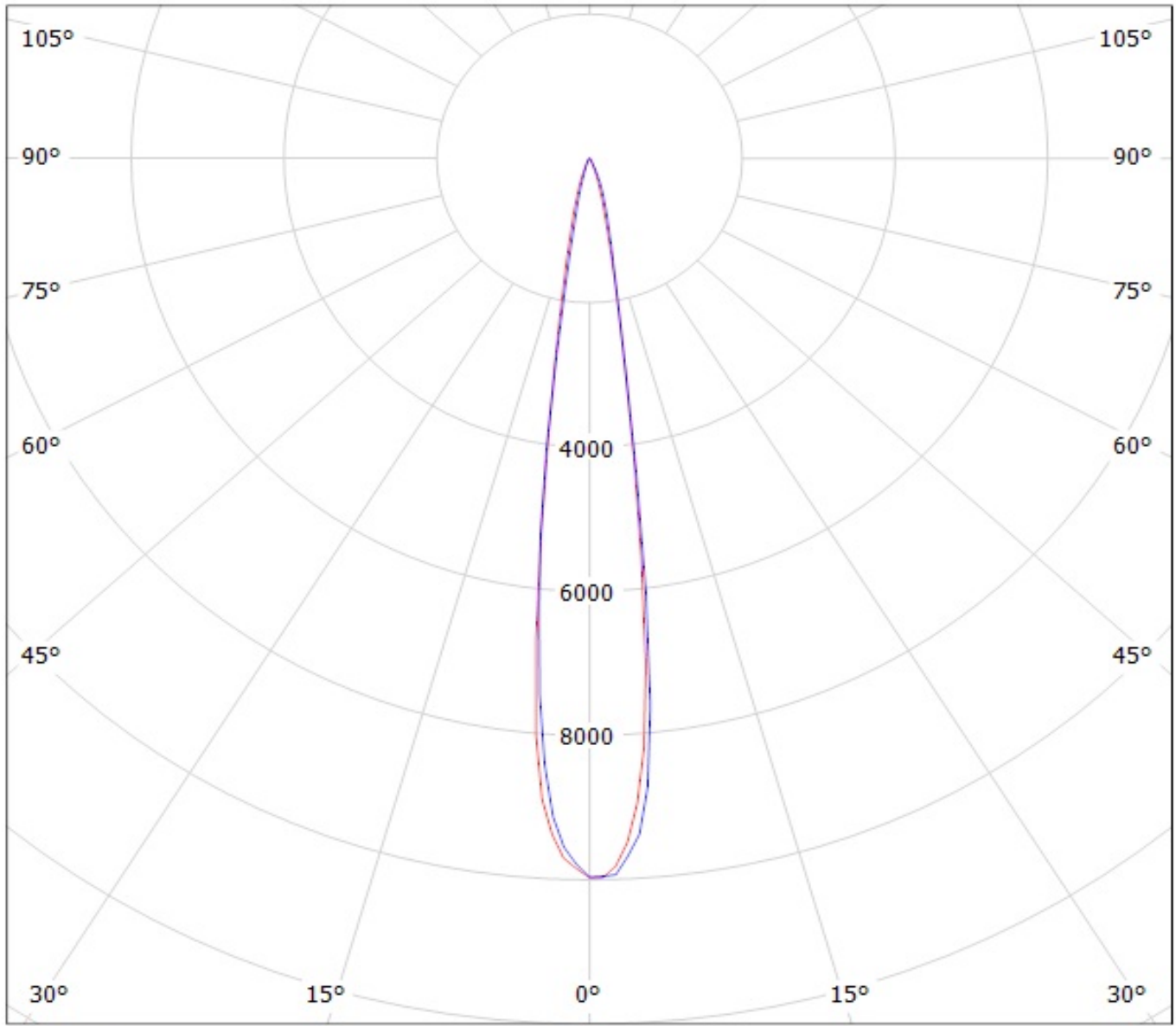

cd/klm

— C0 - C180

— C90 - C270

Luminaire: Ledil Oy CA11016_TINA2-RS (CREE XP-E2 92 lm @ 250 mA) Efficiency=89%
Lamps: 1 x CREE XP-E2 92 lm @ 250 mA

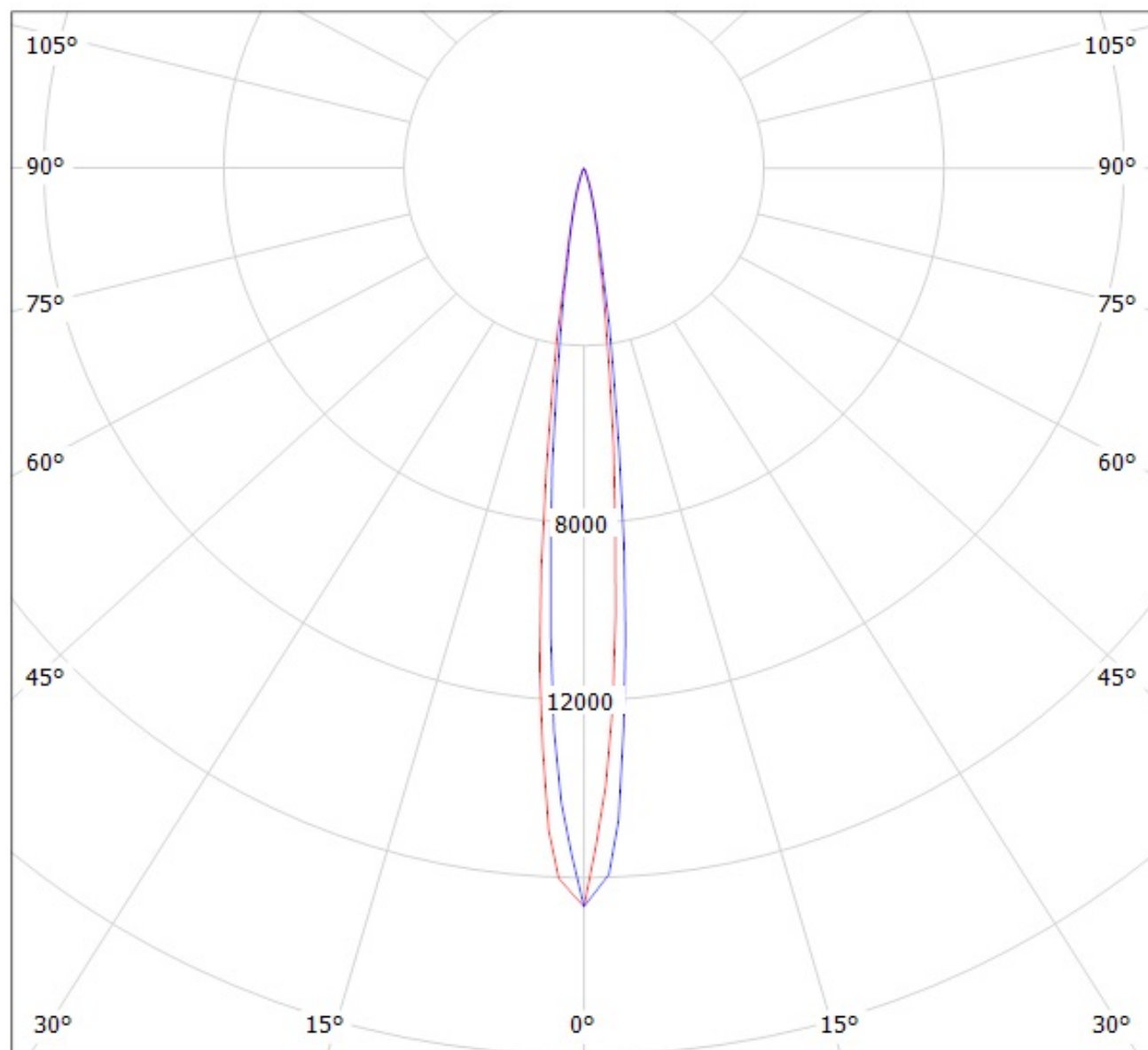

cd/klm

— C0 - C180

— C90 - C270

LEDiL Oy CA11016_TINA2-RS_(3535_Ceramic)_2 Eff.90.7% / LDC (Polar)

Luminaire: LEDiL Oy CA11016_TINA2-RS_(3535_Ceramic)_2 Eff.90.7%

Lamps: 1 x LG 3535 Ceramic (95lm@250mA)

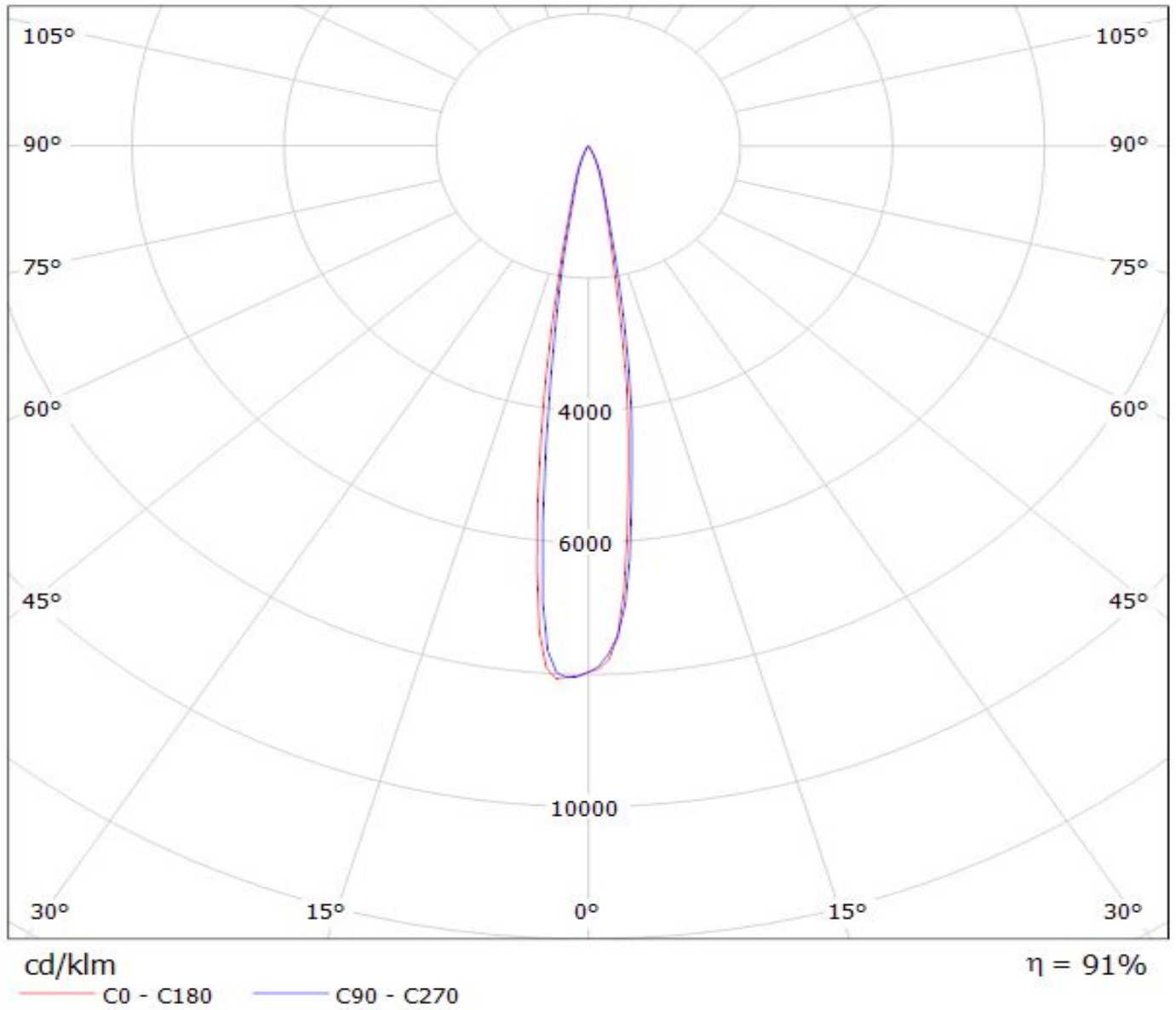

LEDiL Oy CA11016_TINA2_RS_(LG3535_2W) Eff.90.8% / LDC (Polar)

Luminaire: LEDiL Oy CA11016_TINA2_RS_(LG3535_2W) Eff.90.8%

Lamps: 1 x LG3535_2W (97.2479lm@250mA)

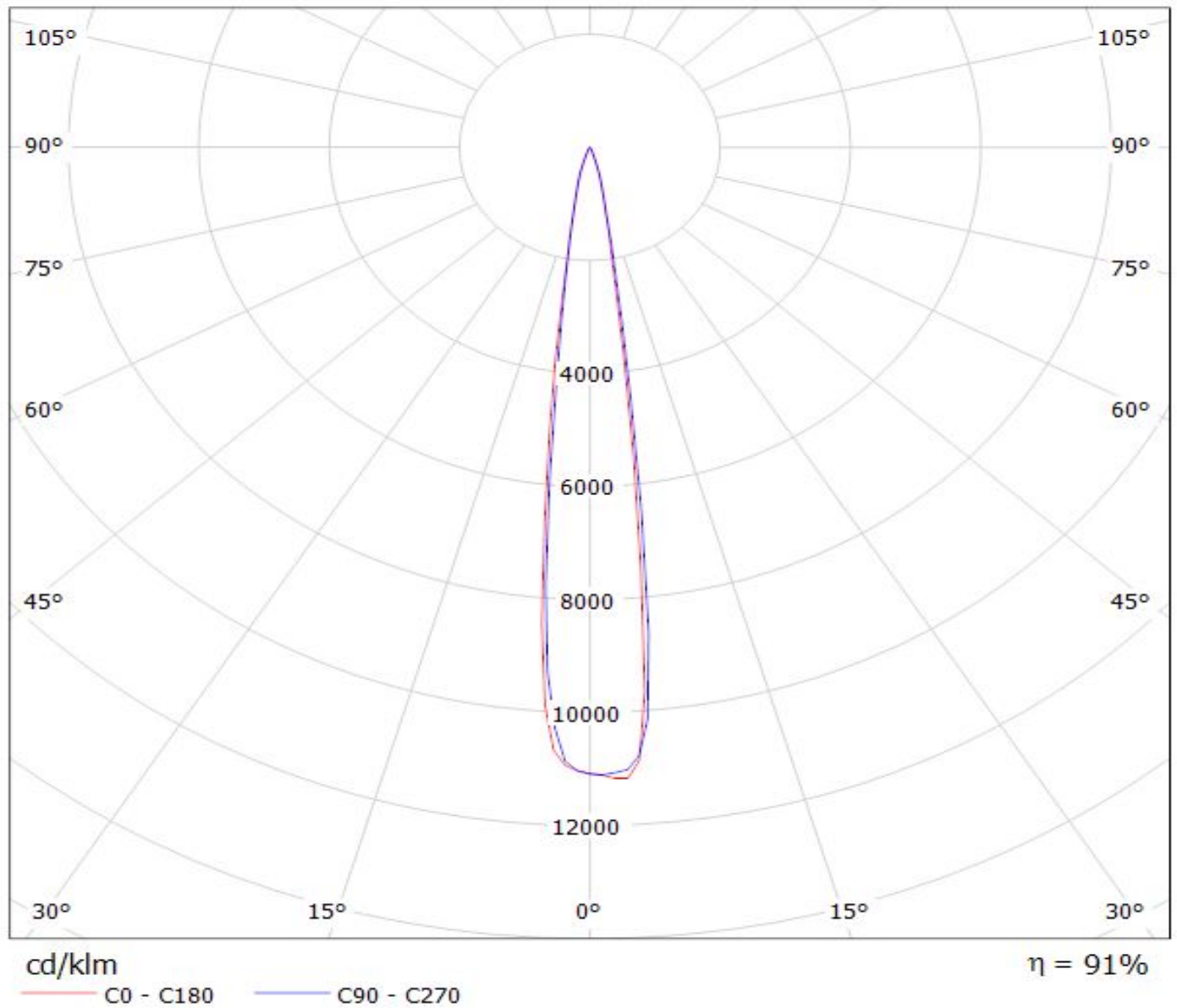

Luminaire: Ledil Oy CA11016_TINA2-RS_(3535_Ceramic_gen2) Efficiency=88%
Lamps: 1 x LG 3535 Ceramic gen2 (PKG5700K) 116lm @ 250mA CCT=6200K P=0.7W I=250mA

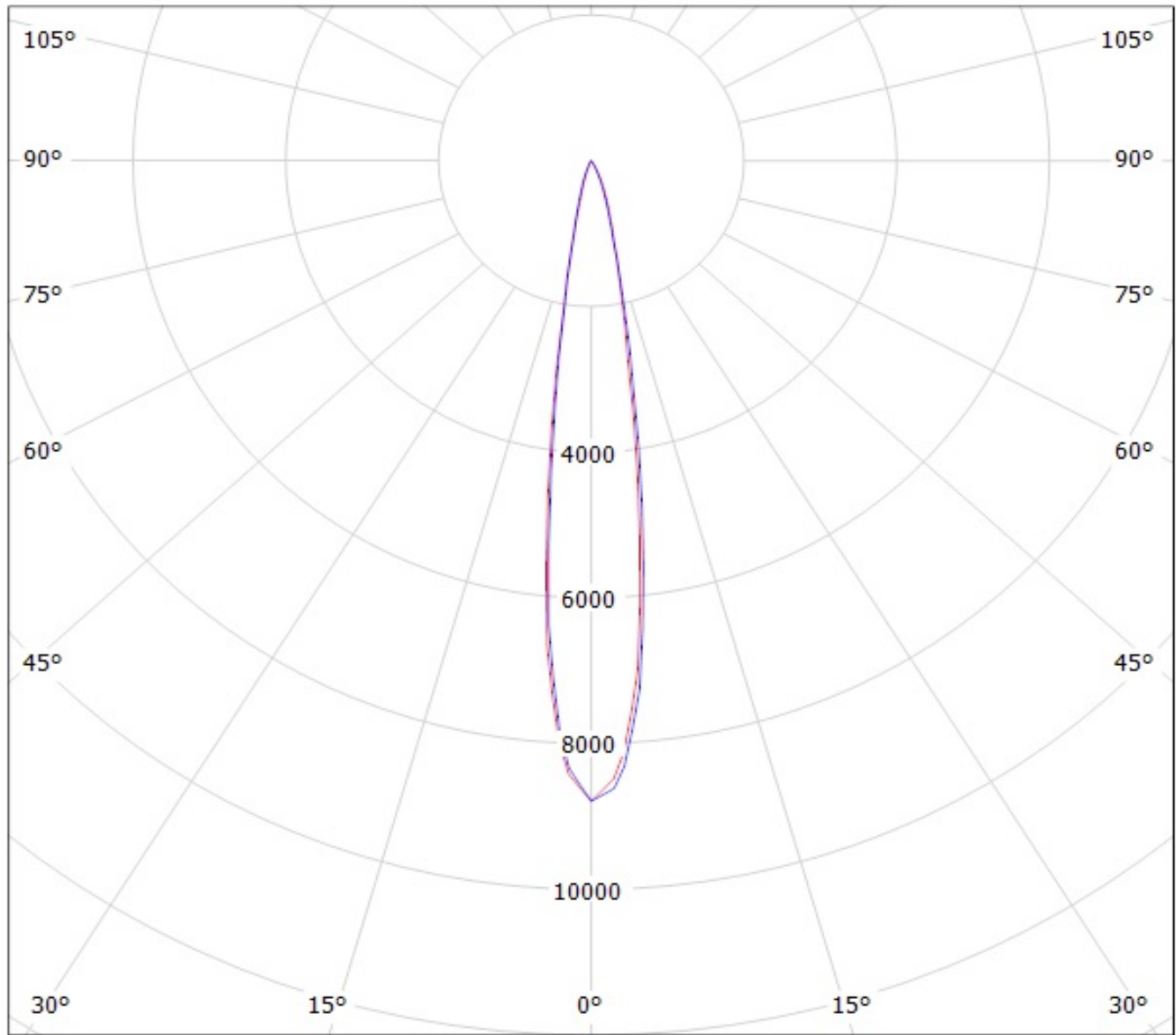

cd/klm

— C0 - C180

— C90 - C270

**Ledil CA11016_TINA2-RS_(Fortimo_FastFlex_LED_board 2x8-757_DS_G3) /
LDC (Polar)**

Luminaire: Ledil CA11016_TINA2-RS_(Fortimo_FastFlex_LED_board 2x8-757_DS_G3)
Lamps: 1 x Philips_Fortimo_FastFlex_LED_board 2x8/757_DS_G3_(XP-G2)
_3428.78lm@500mA_P=23.7W_I=0.5A

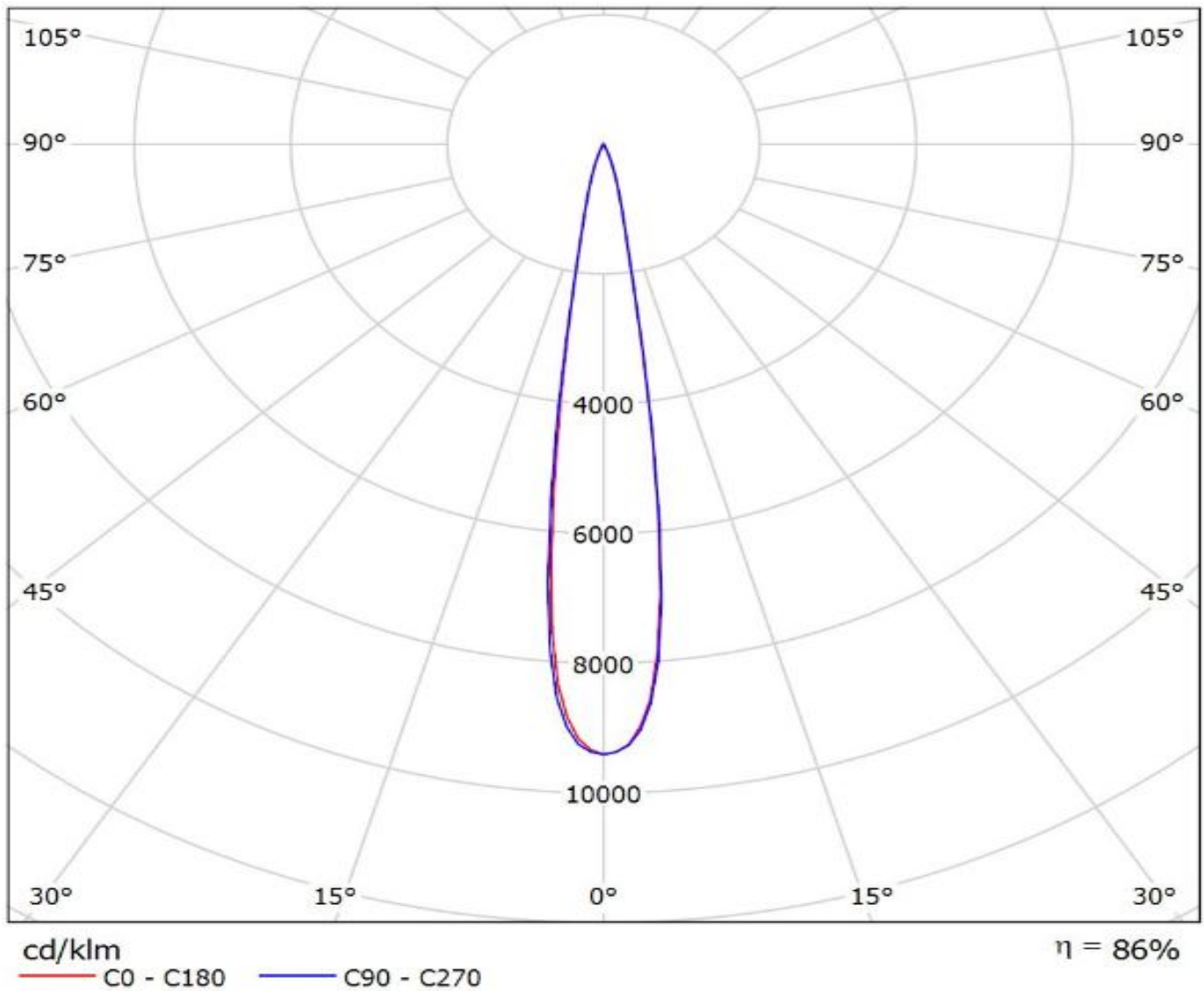

NOTE: The typical divergence will be changed by different color, chip size and chip position tolerance. The typical total divergence is the full angle measured where the luminous intensity is half of the peak value.