

NOTES:

1. MATERIAL:
  - HOUSING: NYLON, GLASS-FILLED, UL94V-0,
  - COLOR: BLACK
  - PIN: 0.50MM SQ, COPPER ALLOY
2. PLATING FINISH:
  - 1) 15µm MIN GOLD PLATE IN SELECTED AREA AND 80µm MIN TIN ON SOLDER TAIL OVER 50µm MIN NICKEL UNDERPLATE OVERALL.
  - 2) 30µm MIN GOLD PLATE IN SELECTED AREA AND 80µm MIN TIN ON SOLDER TAIL OVER 50µm MIN NICKEL UNDERPLATE OVERALL.
  - 3) 100µm MIN TIN OVERALL 50µm MIN NICKEL UNDERPLATE OVERALL.
  - 4) 2-10µm MIN GOLD OVER 50µm MIN NICKEL UNDERPLATE OVERALL.
3. PACKAGING: SEE TABLE
4. RECOMMENDED PCB THICKNESS: 1.60±0.10mm
5. PRODUCT SPECIFICATION: PS-87761-100
6. WAFER TO BE FLAT WITHIN 0.003mm/mm
7. BEND DEPRESSION IS ACCEPTED SO LONG AS IT DOES NOT AFFECT THE OVERALL COPLANARITY OF TAIL
8. COPLANARITY IS TO BE MEASURED BY RESTING THE SOLDER TAIL ON A FLAT SURFACE
9. CAP LOCATION IS CENTERED ALONG THE MATING ENDS AS SHOWN. TOP SURFACE OF CAP TO BE FLAT FOR THE PURPOSE OF PICK & PLACE BY VACUUM SUCTION NOZZLE
10. CKT 4 & 6 IS CUT FROM CKT 8 & 12 RESPECTIVELY. ROUGH EDGES ARE EXPECTED ALONG THE CUTTING EDGES
11. THE ABOVE 8CKTS SHOWN IS FOR ILLUSTRATION ONLY.
12. TUBE LENGTH : 560mm REF.

ADD 87759-1611, 1612, 1613 EC NO: S2009-0622 DRWNATSEE 2009/03/19 CHKD:SKANG 2009/03/24 APPR:MLONG 2009/03/24	REV DESCRIPTION B1	QUALITY SYMBOLS	GENERAL TOLERANCES (UNLESS SPECIFIED)	DIMENSION STYLE	SCALE	DESIGN UNITS	THIRD ANGLE PROJECTION	
		▽=0 ◻=0	mm    INCH 4 PLACES ± --- ± --- 3 PLACES ± --- ± --- 2 PLACES ± 0.2 ± --- 1 PLACE ± --- ± --- ANGULAR ± 3 °	MM ONLY	NTS	METRIC		
			DRAFT WHERE APPLICABLE MUST REMAIN WITHIN DIMENSIONS	DRAWN BY SKLIM01    DATE 2006/03/23 CHECKED BY PATEY    DATE 2006/03/29 APPROVED BY PATEY    DATE 2006/03/29	TITLE	CUSTOM HEADER 2.00MM PITCH DUAL ROW HDR, SINGLE WAFER, SMT		
				MATERIAL NO. SEE TABLE SIZE A3	DOCUMENT NO. SD-87759-277 SHEET NO. 1 OF 12	MOLEX INCORPORATED		

10 9 8 7 6 5 4 3 2 1

PARTS PACK IN TUBE ORIENTATION

CIRCUITS POSITION CONFIGURATION

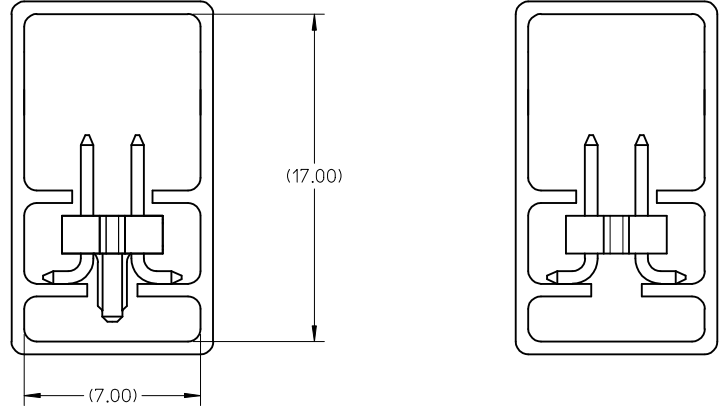
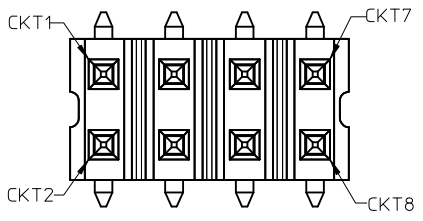

PART WITHOUT CAP IN TUBE  
(PLS REFER TO PK SPEC: PK-89990-475)

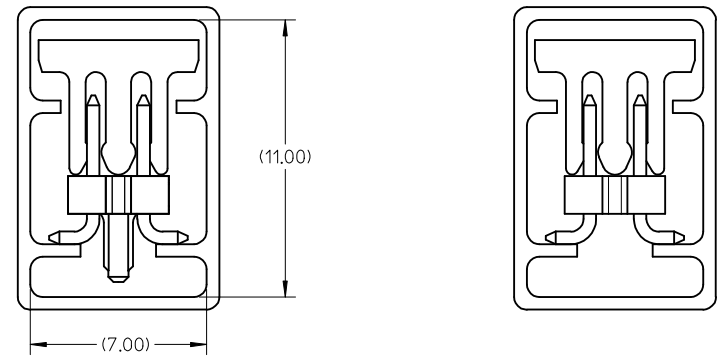

PART WITH CAP IN TUBE  
(PLS REFER TO PK SPEC: PK-89990-476)

ADD 87759-1611, 1612, 1613 EC NO: S2009-0622 DRWNATSEE 2009/03/19 CHYKDSKANG 2009/03/24 APPR:MLONG 2009/03/24	QUALITY SYMBOLS ▽=0 ◻=0	GENERAL TOLERANCES (UNLESS SPECIFIED) mm INCH 4 PLACES ± --- ± --- 3 PLACES ± --- ± --- 2 PLACES ± 0.2 ± --- 1 PLACE ± --- ± --- ANGULAR ± 3 °	DIMENSION STYLE MM ONLY DRAWN BY SKLIM01 DATE 2006/03/23 CHECKED BY PATEY DATE 2006/03/29 APPROVED BY PATEY DATE 2006/03/29	SCALE NTS DESIGN UNITS METRIC THIRD ANGLE PROJECTION	TITLE CUSTOM HEADER 2.00MM PITCH DUAL ROW HDR, SINGLE WAFER, SMT MOLEX INCORPORATED
	DESCRIPTION B1	DRAFT WHERE APPLICABLE MUST REMAIN WITHIN DIMENSIONS	MATERIAL NO. SEE TABLE	DOCUMENT NO. SD-87759-277	SHEET NO. 2 OF 12
	REV B1	SIZE A3	THIS DRAWING CONTAINS INFORMATION THAT IS PROPRIETARY TO MOLEX INCORPORATED AND SHOULD NOT BE USED WITHOUT WRITTEN PERMISSION		

9 8 7 6 5 4 3 2 1

WITH CAP IN TAPE & REEL PACKAGING  
 THE 8CKTS SHOWN AS ABOVE IS FOR  
 ILLUSTRATION PURPOSE ONLY.  
 (THIS TYPE E/TAPE USED FOR CKT 8 TO 14)  
 (PLS REFER TO PK SPEC: PK-89990-484)

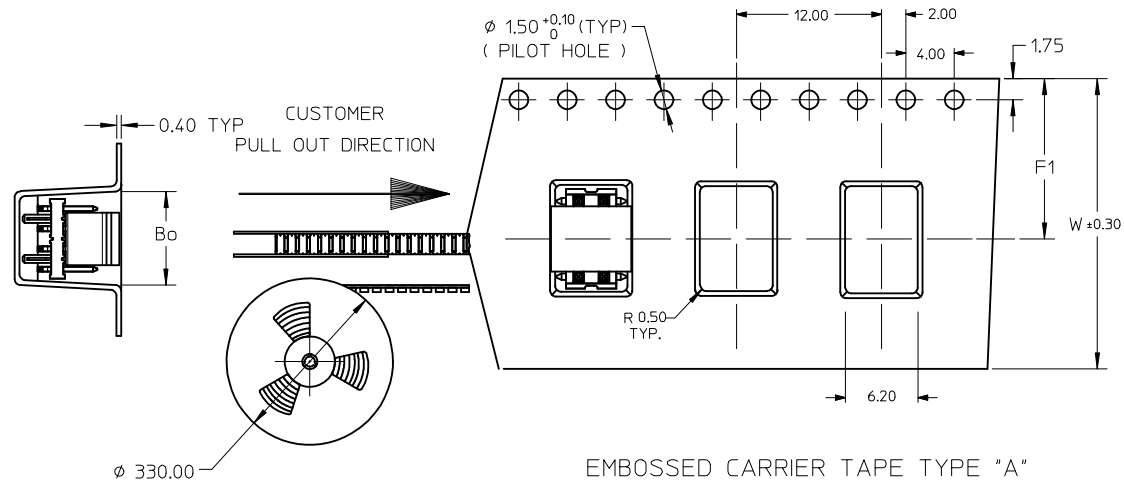

NOTES:

1. LEADER AND TRAILER TAPE

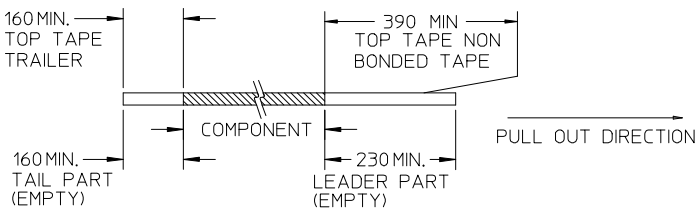

2. PEELING OFF FORCE OF THE TOP TAPE: 20-80gf.  
 (PEELING DIRECTION AS SHOWN IN FOLLOWING FIGURE)

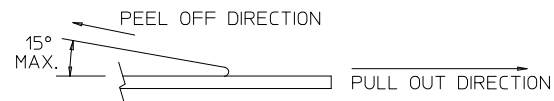

- 3. TAPE AND REEL SPECIFICATION IS AS PER EIA-481.
- 4. TAPE AND REEL QUANTITY : 500PCS/ REEL.
- 5. THE TAPE IS TREATED FOR ANTI-STATIC.

ADD 87759-1611, 1612, 1613 EC NO: S2009-0622 DR:WATSEE 2009/03/19 CHK:SKANG 2009/03/24 APPR:MLONG 2009/03/24	REV DESCRIPTION B1	QUALITY SYMBOLS	GENERAL TOLERANCES (UNLESS SPECIFIED)	DIMENSION STYLE	SCALE	DESIGN UNITS	THIRD ANGLE PROJECTION
		▼=0 ◻=0	mm INCH 4 PLACES ± --- ± --- 3 PLACES ± --- ± --- 2 PLACES ± 0.2 ± --- 1 PLACE ± --- ± --- ANGULAR ± 3 °	MM ONLY	NTS	METRIC	
			DRAWN BY SKLIM01 CHECKED BY PATEY APPROVED BY PATEY MATERIAL NO. SEE TABLE	DATE 2006/03/23 DATE 2006/03/29 DATE 2006/03/29	TITLE		
			DRAFT WHERE APPLICABLE MUST REMAIN WITHIN DIMENSIONS	CUSTOM HEADER 2.00MM PITCH DUAL ROW HDR, SINGLE WAFER, SMT MOLEX INCORPORATED DOCUMENT NO. SD-87759-277			SHEET NO. 3 OF 12

**WITH CAP IN TAPE & REEL PACKAGING**

THE 24CKTS SHOWN ABOVE IS FOR ILLUSTRATION ONLY.  
(THIS TYPE E/TAPE USED FOR CKT 16 TO 50)  
(PLS REFER TO PK SPEC: PK-89990-484)

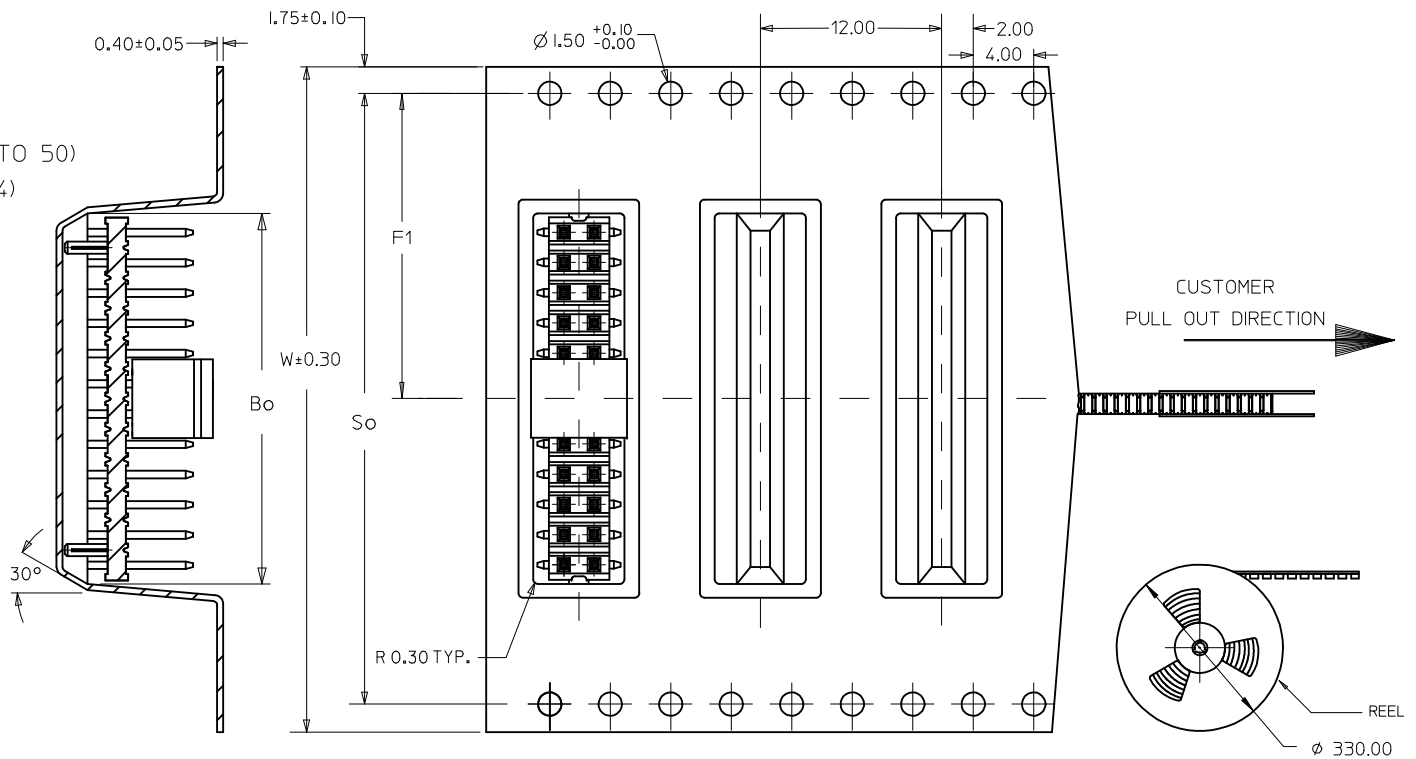

**NOTES:**

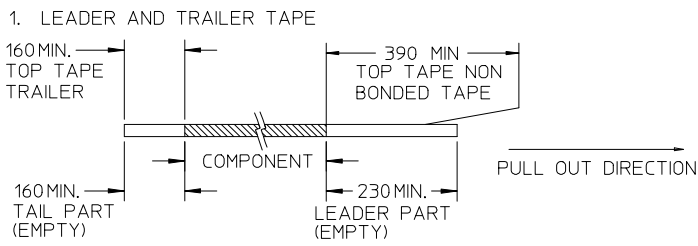

2. PEELING OFF FORCE OF THE TOP TAPE: 20-80gf.  
(PEELING DIRECTION AS SHOWN IN FOLLOWING FIGURE)

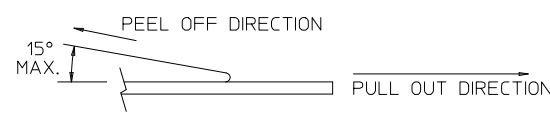



- 3. TAPE AND REEL SPECIFICATION IS AS PER EIA-481.
- 4. TAPE AND REEL QUANTITY : 500 PCS/ REEL.
- 5. THE TAPE IS TREATED FOR ANTI-STATIC.

EMBOSSED CARRIER TAPE TYPE "B"

ADD 87759-1611, 1612, 1613 EC NO: S2009-0622 DRWN:ATSEE 2009/03/19 CHKD:SKANG 2009/03/24 APPR:MLONG 2009/03/24	B1	DESCRIPTION REV	QUALITY SYMBOLS	GENERAL TOLERANCES (UNLESS SPECIFIED)	DIMENSION STYLE	SCALE	DESIGN UNITS	THIRD ANGLE PROJECTION	
			▼=0 ◻=0	mm    INCH 4 PLACES ± --- ± --- 3 PLACES ± --- ± --- 2 PLACES ± 0.2 ± --- 1 PLACE ± --- ± --- ANGULAR ± 3 °	MM ONLY	NTS	METRIC		
					DRAWN BY SKLIM01    DATE 2006/03/23 CHECKED BY    DATE PATEY    2006/03/29 APPROVED BY    DATE PATEY    2006/03/29	TITLE	CUSTOM HEADER 2.00MM PITCH DUAL ROW HDR, SINGLE WAFER, SMT		
				DRAFT WHERE APPLICABLE MUST REMAIN WITHIN DIMENSIONS	MATERIAL NO.    DOCUMENT NO. SEE TABLE    SD-87759-277	SHEET NO. 4 OF 12			

	10	9	8	7	6	5	4	3	2	1									
	PART NUMBER WITHOUT CAP IN TRAY	PART NUMBER WITHOUT CAP IN TUBE	PART NUMBER WITH CAP IN TUBE	PART NUMBER WITH CAP IN TAPE & REEL	CKT SIZE	PLATING TYPE	VOID POSITION	A	B	C	M	(F)	(G)	Bo	F1	So	W	EMBOSSED TYPE	
F	87759-0461	-----	-----	-----	4	N	1	-----	3.90	2.00	---	3.20	5.90	8.10	-	-	-	-	-
	87759-0462	-----	-----	-----	4	N	2	-----	3.90	2.00	---	3.20	5.90	8.10	-	-	-	-	-
	87759-0463	-----	-----	-----	4	N	3	-----	3.90	2.00	---	3.20	5.90	8.10	-	-	-	-	-
E	87759-0661	-----	-----	-----	6	N	1	-----	7.90	6.00	---	3.20	5.90	8.10	-	-	-	-	-
	87759-0662	-----	-----	-----	6	N	2	-----	7.90	6.00	---	3.20	5.90	8.10	-	-	-	-	-
	87759-0663	-----	-----	-----	6	N	3	-----	7.90	6.00	---	3.20	5.90	8.10	-	-	-	-	-
	-----	87759-0861	87759-0871	87759-0881	8	N	1	-----	7.90	6.00	---	3.20	5.90	8.10	8.50	11.50	-	24.00	A
	-----	87759-0862	87759-0872	87759-0882	8	N	2	-----	7.90	6.00	---	3.20	5.90	8.10	8.50	11.50	-	24.00	A
	-----	87759-0863	87759-0873	87759-0883	8	N	3	-----	7.90	6.00	---	3.20	5.90	8.10	8.50	11.50	-	24.00	A
D	-----	87759-6081	87759-7081	87759-8081	8	Y	1	-----	7.90	6.00	4.00	3.20	5.90	8.10	8.50	11.50	-	24.00	A
	-----	87759-6082	87759-7082	87759-8082	8	Y	2	-----	7.90	6.00	4.00	3.20	5.90	8.10	8.50	11.50	-	24.00	A
	-----	87759-6083	87759-7083	87759-8083	8	Y	3	-----	7.90	6.00	4.00	3.20	5.90	8.10	8.50	11.50	-	24.00	A



ADD 87759-1611, 1612, 1613 EC NO: S2009-0622 DRWN:ATSEE 2009/03/19 CHKD:SKANG 2009/03/24 APPR:MLONG 2009/03/24	QUALITY SYMBOLS	GENERAL TOLERANCES (UNLESS SPECIFIED)	DIMENSION STYLE	SCALE	DESIGN UNITS	THIRD ANGLE PROJECTION																				
	 = 0  = 0	<table border="1"> <tr> <th></th> <th>mm</th> <th>INCH</th> </tr> <tr> <td>4 PLACES</td> <td>± ---</td> <td>± ---</td> </tr> <tr> <td>3 PLACES</td> <td>± ---</td> <td>± ---</td> </tr> <tr> <td>2 PLACES</td> <td>± 0.2</td> <td>± ---</td> </tr> <tr> <td>1 PLACE</td> <td>± ---</td> <td>± ---</td> </tr> </table>		mm	INCH	4 PLACES	± ---	± ---	3 PLACES	± ---	± ---	2 PLACES	± 0.2	± ---	1 PLACE	± ---	± ---	MM ONLY	NTS	METRIC						
		mm	INCH																							
	4 PLACES	± ---	± ---																							
3 PLACES	± ---	± ---																								
2 PLACES	± 0.2	± ---																								
1 PLACE	± ---	± ---																								
DESCRIPTION	<table border="1"> <tr> <td>DRAWN BY</td> <td>DATE</td> <td>TITLE</td> </tr> <tr> <td>SKLIM01</td> <td>2006/03/23</td> <td>CUSTOM HEADER</td> </tr> <tr> <td>CHECKED BY</td> <td>DATE</td> <td>2.00MM PITCH DUAL ROW</td> </tr> <tr> <td>PATEY</td> <td>2006/03/29</td> <td>HDR, SINGLE WAFER, SMT</td> </tr> <tr> <td>APPROVED BY</td> <td>DATE</td> <td>MOLEX INCORPORATED</td> </tr> <tr> <td>PATEY</td> <td>2006/03/29</td> <td></td> </tr> </table>	DRAWN BY	DATE	TITLE	SKLIM01	2006/03/23	CUSTOM HEADER	CHECKED BY	DATE	2.00MM PITCH DUAL ROW	PATEY	2006/03/29	HDR, SINGLE WAFER, SMT	APPROVED BY	DATE	MOLEX INCORPORATED	PATEY	2006/03/29		<table border="1"> <tr> <td>MATERIAL NO.</td> <td>DOCUMENT NO.</td> <td>SHEET NO.</td> </tr> <tr> <td>SEE TABLE</td> <td>SD-87759-277</td> <td>5 OF 12</td> </tr> </table>	MATERIAL NO.	DOCUMENT NO.	SHEET NO.	SEE TABLE	SD-87759-277	5 OF 12
DRAWN BY	DATE	TITLE																								
SKLIM01	2006/03/23	CUSTOM HEADER																								
CHECKED BY	DATE	2.00MM PITCH DUAL ROW																								
PATEY	2006/03/29	HDR, SINGLE WAFER, SMT																								
APPROVED BY	DATE	MOLEX INCORPORATED																								
PATEY	2006/03/29																									
MATERIAL NO.	DOCUMENT NO.	SHEET NO.																								
SEE TABLE	SD-87759-277	5 OF 12																								
REV	DRAFT WHERE APPLICABLE MUST REMAIN WITHIN DIMENSIONS		THIS DRAWING CONTAINS INFORMATION THAT IS PROPRIETARY TO MOLEX INCORPORATED AND SHOULD NOT BE USED WITHOUT WRITTEN PERMISSION																							

10	9	8	7	6	5	4	3	2	1								
PART NUMBER WITHOUT CAP IN TUBE	PART NUMBER WITH CAP IN TUBE	PART NUMBER WITH CAP IN TAPE & REEL	CKT SIZE	PEG	PLATING TYPE	VOID POSITION	A	B	C	M	(F)	(G)	Bo	F1	So	W	EMBOSSSED TYPE
87759-1061	87759-1071	87759-1081	10	N	1	-----	9.90	8.00	---	3.20	5.90	8.10	10.50	11.50	-	24.00	A
87759-1062	87759-1072	87759-1082	10	N	2	-----	9.90	8.00	---	3.20	5.90	8.10	10.50	11.50	-	24.00	A
87759-1063	87759-1073	87759-1083	10	N	3	-----	9.90	8.00	---	3.20	5.90	8.10	10.50	11.50	-	24.00	A
87759-6101	87759-7101	87759-8101	10	Y	1	-----	9.90	8.00	6.00	3.20	5.90	8.10	10.50	11.50	-	24.00	A
87759-6102	87759-7102	87759-8102	10	Y	2	-----	9.90	8.00	6.00	3.20	5.90	8.10	10.50	11.50	-	24.00	A
87759-6103	87759-7103	87759-8103	10	Y	3	-----	9.90	8.00	6.00	3.20	5.90	8.10	10.50	11.50	-	24.00	A
87759-1261	87759-1271	87759-1281	12	N	1	-----	11.90	10.00	---	3.20	5.90	8.10	12.50	11.50	-	24.00	A
87759-1262	87759-1272	87759-1282	12	N	2	-----	11.90	10.00	---	3.20	5.90	8.10	12.50	11.50	-	24.00	A
87759-1263	87759-1273	87759-1283	12	N	3	-----	11.90	10.00	---	3.20	5.90	8.10	12.50	11.50	-	24.00	A
87759-6121	87759-7121	87759-8121	12	Y	1	-----	11.90	10.00	---	3.20	5.90	8.10	12.50	11.50	-	24.00	A
87759-6122	87759-7122	87759-8122	12	Y	2	-----	11.90	10.00	---	3.20	5.90	8.10	12.50	11.50	-	24.00	A
87759-6123	87759-7123	87759-8123	12	Y	3	-----	11.90	10.00	---	3.20	5.90	8.10	12.50	11.50	-	24.00	A
87759-1461	87759-1471	87759-1481	14	N	1	-----	13.90	12.00	---	3.20	5.90	8.10	14.50	11.50	-	24.00	A
87759-1462	87759-1472	87759-1482	14	N	2	-----	13.90	12.00	---	3.20	5.90	8.10	14.50	11.50	-	24.00	A
87759-1463	87759-1473	87759-1483	14	N	3	-----	13.90	12.00	---	3.20	5.90	8.10	14.50	11.50	-	24.00	A
87759-6141	87759-7141	87759-8141	14	Y	1	-----	13.90	12.00	---	3.20	5.90	8.10	14.50	11.50	-	24.00	A
87759-6142	87759-7142	87759-8142	14	Y	2	-----	13.90	12.00	---	3.20	5.90	8.10	14.50	11.50	-	24.00	A
87759-6143	87759-7143	87759-8143	14	Y	3	-----	13.90	12.00	---	3.20	5.90	8.10	14.50	11.50	-	24.00	A

ADD 87759-1611, 1612, 1613 EC NO: S2009-0622 DRWN:ATSEE 2009/03/19 CHKD:SKANG 2009/03/24 APPR:MLONG 2009/03/24	REV DESCRIPTION B1	QUALITY SYMBOLS = 0 = 0.2	GENERAL TOLERANCES (UNLESS SPECIFIED) <table border="1"> <tr> <td></td> <td>mm</td> <td>INCH</td> </tr> <tr> <td>4 PLACES</td> <td>± ---</td> <td>± ---</td> </tr> <tr> <td>3 PLACES</td> <td>± ---</td> <td>± ---</td> </tr> <tr> <td>2 PLACES</td> <td>± 0.2</td> <td>± ---</td> </tr> <tr> <td>1 PLACE</td> <td>± ---</td> <td>± ---</td> </tr> </table>		mm	INCH	4 PLACES	± ---	± ---	3 PLACES	± ---	± ---	2 PLACES	± 0.2	± ---	1 PLACE	± ---	± ---	DIMENSION STYLE <b>MM ONLY</b>	SCALE <b>NTS</b>	DESIGN UNITS <b>METRIC</b>	THIRD ANGLE PROJECTION
			mm	INCH																		
		4 PLACES	± ---	± ---																		
		3 PLACES	± ---	± ---																		
2 PLACES	± 0.2	± ---																				
1 PLACE	± ---	± ---																				
DRAWN BY SKLIM01	DATE 2006/03/23	TITLE <b>CUSTOM HEADER          2.00MM PITCH DUAL ROW          HDR, SINGLE WAFER, SMT</b>																				
CHECKED BY PATEY	DATE 2006/03/29	<b>MOLEX INCORPORATED</b>																				
APPROVED BY PATEY	DATE 2006/03/29	MATERIAL NO. <b>SEE TABLE</b>	DOCUMENT NO. <b>SD-87759-277</b>	SHEET NO. <b>6 OF 12</b>																		

	10	9	8	7	6	5	4	3	2	1								
	PART NUMBER WITHOUT CAP IN TUBE	PART NUMBER WITH CAP IN TUBE	PART NUMBER WITH CAP IN TAPE & REEL	CKT SIZE	PLATING TYPE	VOID POSITION	A	B	C	M	(F)	(G)	Bo	F1	So	W	EMBOSSED TYPE	
F	87759-1661	87759-1671	87759-1681	16	N	1	-----	15.90	14.00	---	3.20	5.90	8.10	16.50	14.20	28.40	32.00	B
	87759-1662	87759-1672	87759-1682	16	N	2	-----	15.90	14.00	---	3.20	5.90	8.10	16.50	14.20	28.40	32.00	B
	87759-1663	87759-1673	87759-1683	16	N	3	-----	15.90	14.00	---	3.20	5.90	8.10	16.50	14.20	28.40	32.00	B
	87759-6161	87759-7161	87759-8161	16	Y	1	-----	15.90	14.00	---	3.20	5.90	8.10	16.50	14.20	28.40	32.00	B
	87759-6162	87759-7162	87759-8162	16	Y	2	-----	15.90	14.00	---	3.20	5.90	8.10	16.50	14.20	28.40	32.00	B
	87759-6163	87759-7163	87759-8163	16	Y	3	-----	15.90	14.00	---	3.20	5.90	8.10	16.50	14.20	28.40	32.00	B
E	87759-1611	87759-1612	87759-1613	16	N	4	-----	15.90	14.00	---	5.50	8.20	9.60	16.50	14.20	28.40	32.00	B
	87759-1861	87759-1871	87759-1881	18	N	1	-----	17.90	16.00	---	3.20	5.90	8.10	18.50	14.20	28.40	32.00	B
	87759-1862	87759-1872	87759-1882	18	N	2	-----	17.90	16.00	---	3.20	5.90	8.10	18.50	14.20	28.40	32.00	B
	87759-1863	87759-1873	87759-1883	18	N	3	-----	17.90	16.00	---	3.20	5.90	8.10	18.50	14.20	28.40	32.00	B
	87759-6181	87759-7181	87759-8181	18	Y	1	-----	17.90	16.00	---	3.20	5.90	8.10	18.50	14.20	28.40	32.00	B
	87759-6182	87759-7182	87759-8182	18	Y	2	-----	17.90	16.00	---	3.20	5.90	8.10	18.50	14.20	28.40	32.00	B
	87759-6183	87759-7183	87759-8183	18	Y	3	-----	17.90	16.00	---	3.20	5.90	8.10	18.50	14.20	28.40	32.00	B
	87759-2061	87759-2071	87759-2081	20	N	1	-----	19.90	18.00	---	3.20	5.90	8.10	20.50	20.20	40.40	44.00	B
	87759-2062	87759-2072	87759-2082	20	N	2	-----	19.90	18.00	---	3.20	5.90	8.10	20.50	20.20	40.40	44.00	B
	87759-2063	87759-2073	87759-2083	20	N	3	-----	19.90	18.00	---	3.20	5.90	8.10	20.50	20.20	40.40	44.00	B
	87759-6201	87759-7201	87759-8201	20	Y	1	-----	19.90	18.00	---	3.20	5.90	8.10	20.50	20.20	40.40	44.00	B
	87759-6202	87759-7202	87759-8202	20	Y	2	-----	19.90	18.00	---	3.20	5.90	8.10	20.50	20.20	40.40	44.00	B
	87759-6203	87759-7203	87759-8203	20	Y	3	-----	19.90	18.00	---	3.20	5.90	8.10	20.50	20.20	40.40	44.00	B

B

ADD 87759-1611, 1612, 1613 EC NO: S2009-0622 DRWN:ATSEE 2009/03/19 CHKD:SKANG 2009/03/24 APPR:MLONG 2009/03/24	QUALITY SYMBOLS	GENERAL TOLERANCES (UNLESS SPECIFIED)	DIMENSION STYLE	SCALE	DESIGN UNITS	THIRD ANGLE PROJECTION	
	 = 0  = 0.2	mm      INCH 4 PLACES ± --- ± --- 3 PLACES ± --- ± --- 2 PLACES ± 0.2 ± --- 1 PLACE ± --- ± --- ANGULAR ± 3 °	MM ONLY	NTS	METRIC		
	REV	DESCRIPTION	DRAWN BY	DATE	TITLE		
	B1		SKLIM01	2006/03/23	CUSTOM HEADER 2.00MM PITCH DUAL ROW HDR, SINGLE WAFER, SMT		
			CHECKED BY	DATE	MOLEX INCORPORATED		
			PATEY	2006/03/29	DOCUMENT NO. SD-87759-277		
			APPROVED BY	DATE	SHEET NO. 7 OF 12		
			PATEY	2006/03/29	THIS DRAWING CONTAINS INFORMATION THAT IS PROPRIETARY TO MOLEX INCORPORATED AND SHOULD NOT BE USED WITHOUT WRITTEN PERMISSION		

	10	9	8	7	6	5	4	3	2	1								
	PART NUMBER WITHOUT CAP IN TUBE	PART NUMBER WITH CAP IN TUBE	PART NUMBER WITH CAP IN TAPE & REEL	CKT SIZE	PLATING TYPE	VOID POSITION	A	B	C	M	(F)	(G)	Bo	F1	So	W	EMBOSSED TYPE	
F	87759-2261	87759-2271	87759-2281	22	N	1	-----	21.90	20.00	---	3.20	5.90	8.10	22.50	20.20	40.40	44.00	B
	87759-2262	87759-2272	87759-2282	22	N	2	-----	21.90	20.00	---	3.20	5.90	8.10	22.50	20.20	40.40	44.00	B
	87759-2263	87759-2273	87759-2283	22	N	3	-----	21.90	20.00	---	3.20	5.90	8.10	22.50	20.20	40.40	44.00	B
	87759-6221	87759-7221	87759-8221	22	Y	1	-----	21.90	20.00	---	3.20	5.90	8.10	22.50	20.20	40.40	44.00	B
	87759-6222	87759-7222	87759-8222	22	Y	2	-----	21.90	20.00	---	3.20	5.90	8.10	22.50	20.20	40.40	44.00	B
E	87759-6223	87759-7223	87759-8223	22	Y	3	-----	21.90	20.00	---	3.20	5.90	8.10	22.50	20.20	40.40	44.00	B
	87759-2461	87759-2471	87759-2481	24	N	1	-----	23.90	22.00	---	3.20	5.90	8.10	24.50	20.20	40.40	44.00	B
	87759-2462	87759-2472	87759-2482	24	N	2	-----	23.90	22.00	---	3.20	5.90	8.10	24.50	20.20	40.40	44.00	B
	87759-2463	87759-2473	87759-2483	24	N	3	-----	23.90	22.00	---	3.20	5.90	8.10	24.50	20.20	40.40	44.00	B
D	87759-6241	87759-7241	87759-8241	24	Y	1	-----	23.90	22.00	---	3.20	5.90	8.10	24.50	20.20	40.40	44.00	B
	87759-6242	87759-7242	87759-8242	24	Y	2	-----	23.90	22.00	---	3.20	5.90	8.10	24.50	20.20	40.40	44.00	B
	87759-6243	87759-7243	87759-8243	24	Y	3	-----	23.90	22.00	---	3.20	5.90	8.10	24.50	20.20	40.40	44.00	B
	87759-2661	87759-2671	87759-2681	26	N	1	-----	25.90	24.00	---	3.20	5.90	8.10	26.50	20.20	40.40	44.00	B
	87759-2662	87759-2672	87759-2682	26	N	2	-----	25.90	24.00	---	3.20	5.90	8.10	26.50	20.20	40.40	44.00	B
	87759-2663	87759-2673	87759-2683	26	N	3	-----	25.90	24.00	---	3.20	5.90	8.10	26.50	20.20	40.40	44.00	B
C	87759-6261	87759-7261	87759-8261	26	Y	1	-----	25.90	24.00	---	3.20	5.90	8.10	26.50	20.20	40.40	44.00	B
	87759-6262	87759-7262	87759-8262	26	Y	2	-----	25.90	24.00	---	3.20	5.90	8.10	26.50	20.20	40.40	44.00	B
	87759-6263	87759-7263	87759-8263	26	Y	3	-----	25.90	24.00	---	3.20	5.90	8.10	26.50	20.20	40.40	44.00	B

ADD 87759-1611, 1612, 1613 EC NO: S2009-0622 DRWN:ATSEE 2009/03/19 CHKD:SKANG 2009/03/24 APPR:MLONG 2009/03/24	REV DESCRIPTION B1	QUALITY SYMBOLS =0 =0	GENERAL TOLERANCES (UNLESS SPECIFIED) <table border="1"> <tr> <td></td> <td>mm</td> <td>INCH</td> </tr> <tr> <td>4 PLACES</td> <td>± ---</td> <td>± ---</td> </tr> <tr> <td>3 PLACES</td> <td>± ---</td> <td>± ---</td> </tr> <tr> <td>2 PLACES</td> <td>± 0.2</td> <td>± ---</td> </tr> <tr> <td>1 PLACE</td> <td>± ---</td> <td>± ---</td> </tr> </table>		mm	INCH	4 PLACES	± ---	± ---	3 PLACES	± ---	± ---	2 PLACES	± 0.2	± ---	1 PLACE	± ---	± ---	DIMENSION STYLE <b>MM ONLY</b> DRAWN BY: SKLIM01 DATE: 2006/03/23 CHECKED BY: PATEY DATE: 2006/03/29 APPROVED BY: PATEY DATE: 2006/03/29	SCALE: NTS DESIGN UNITS: METRIC THIRD ANGLE PROJECTION	TITLE: <b>CUSTOM HEADER          2.00MM PITCH DUAL ROW          HDR, SINGLE WAFER, SMT</b> <b>MOLEX INCORPORATED</b> MATERIAL NO. SEE TABLE DOCUMENT NO. SD-87759-277
			mm	INCH																	
		4 PLACES	± ---	± ---																	
		3 PLACES	± ---	± ---																	
2 PLACES	± 0.2	± ---																			
1 PLACE	± ---	± ---																			
DRAFT WHERE APPLICABLE MUST REMAIN WITHIN DIMENSIONS		SIZE: A3 THIS DRAWING CONTAINS INFORMATION THAT IS PROPRIETARY TO MOLEX INCORPORATED AND SHOULD NOT BE USED WITHOUT WRITTEN PERMISSION	SHEET NO. 8 OF 12																		



10	9	8	7	6	5	4	3	2	1								
PART NUMBER WITHOUT CAP IN TUBE	PART NUMBER WITH CAP IN TUBE	PART NUMBER WITH CAP IN TAPE & REEL	CKT SIZE	PLATING TYPE	VOID POSITION	A	B	C	M	(F)	(G)	Bo	F1	So	W	EMBOSSED TYPE	
87759-2861	87759-2871	87759-2881	28	N	1	-----	27.90	26.00	---	3.20	5.90	8.10	28.50	20.20	40.40	44.00	B
87759-2862	87759-2872	87759-2882	28	N	2	-----	27.90	26.00	---	3.20	5.90	8.10	28.50	20.20	40.40	44.00	B
87759-2863	87759-2873	87759-2883	28	N	3	-----	27.90	26.00	---	3.20	5.90	8.10	28.50	20.20	40.40	44.00	B
87759-6281	87759-7281	87759-8281	28	Y	1	-----	27.90	26.00	---	3.20	5.90	8.10	28.50	20.20	40.40	44.00	B
87759-6282	87759-7282	87759-8282	28	Y	2	-----	27.90	26.00	---	3.20	5.90	8.10	28.50	20.20	40.40	44.00	B
87759-6283	87759-7283	87759-8283	28	Y	3	-----	27.90	26.00	---	3.20	5.90	8.10	28.50	20.20	40.40	44.00	B
87759-3061	87759-3071	87759-3081	30	N	1	-----	29.90	28.00	---	3.20	5.90	8.10	30.50	20.20	40.40	44.00	B
87759-3062	87759-3072	87759-3082	30	N	2	-----	29.90	28.00	---	3.20	5.90	8.10	30.50	20.20	40.40	44.00	B
87759-3063	87759-3073	87759-3083	30	N	3	-----	29.90	28.00	---	3.20	5.90	8.10	30.50	20.20	40.40	44.00	B
87759-6301	87759-7301	87759-8301	30	Y	1	-----	29.90	28.00	---	3.20	5.90	8.10	30.50	20.20	40.40	44.00	B
87759-6302	87759-7302	87759-8302	30	Y	2	-----	29.90	28.00	---	3.20	5.90	8.10	30.50	20.20	40.40	44.00	B
87759-6303	87759-7303	87759-8303	30	Y	3	-----	29.90	28.00	---	3.20	5.90	8.10	30.50	20.20	40.40	44.00	B
87759-3261	87759-3271	87759-3281	32	N	1	-----	31.90	30.00	---	3.20	5.90	8.10	32.50	26.20	52.40	56.00	B
87759-3262	87759-3272	87759-3282	32	N	2	-----	31.90	30.00	---	3.20	5.90	8.10	32.50	26.20	52.40	56.00	B
87759-3263	87759-3273	87759-3283	32	N	3	-----	31.90	30.00	---	3.20	5.90	8.10	32.50	26.20	52.40	56.00	B
87759-6321	87759-7321	87759-8321	32	Y	1	-----	31.90	30.00	---	3.20	5.90	8.10	32.50	26.20	52.40	56.00	B
87759-6322	87759-7322	87759-8322	32	Y	2	-----	31.90	30.00	---	3.20	5.90	8.10	32.50	26.20	52.40	56.00	B
87759-6323	87759-7323	87759-8323	32	Y	3	-----	31.90	30.00	---	3.20	5.90	8.10	32.50	26.20	52.40	56.00	B

B									
---	--	--	--	--	--	--	--	--	--

ADD 87759-1611, 1612, 1613 EC NO: S2009-0622 DRWN:ATSEE 2009/03/19 CHKD:SKANG 2009/03/24 APPR:MLONG 2009/03/24	QUALITY SYMBOLS =0 =0	GENERAL TOLERANCES (UNLESS SPECIFIED) <table border="1"> <tr> <td></td> <td>mm</td> <td>INCH</td> </tr> <tr> <td>4 PLACES</td> <td>± ---</td> <td>± ---</td> </tr> <tr> <td>3 PLACES</td> <td>± ---</td> <td>± ---</td> </tr> <tr> <td>2 PLACES</td> <td>± 0.2</td> <td>± ---</td> </tr> <tr> <td>1 PLACE</td> <td>± ---</td> <td>± ---</td> </tr> </table>		mm	INCH	4 PLACES	± ---	± ---	3 PLACES	± ---	± ---	2 PLACES	± 0.2	± ---	1 PLACE	± ---	± ---	DIMENSION STYLE <b>MM ONLY</b>	SCALE <b>NTS</b>	DESIGN UNITS <b>METRIC</b>	THIRD ANGLE PROJECTION	DRAWN BY SKLIM01	DATE 2006/03/23	TITLE <b>CUSTOM HEADER          2.00MM PITCH DUAL ROW          HDR, SINGLE WAFER, SMT</b>
		mm	INCH																					
	4 PLACES	± ---	± ---																					
	3 PLACES	± ---	± ---																					
2 PLACES	± 0.2	± ---																						
1 PLACE	± ---	± ---																						
CHECKED BY PATEY	DATE 2006/03/29	APPROVED BY PATEY	DATE 2006/03/29	<b>MOLEX INCORPORATED</b>	MATERIAL NO. <b>SEE TABLE</b>	DOCUMENT NO. <b>SD-87759-277</b>	SHEET NO. <b>9 OF 12</b>																	
DRAFT WHERE APPLICABLE MUST REMAIN WITHIN DIMENSIONS		THIS DRAWING CONTAINS INFORMATION THAT IS PROPRIETARY TO MOLEX INCORPORATED AND SHOULD NOT BE USED WITHOUT WRITTEN PERMISSION																						
REV <b>B1</b>																								

10	9	8	7	6	5	4	3	2	1								
PART NUMBER WITHOUT CAP IN TUBE	PART NUMBER WITH CAP IN TUBE	PART NUMBER WITH CAP IN TAPE & REEL	CKT SIZE	PLATING TYPE	VOID POSITION	A	B	C	M	(F)	(G)	Bo	F1	So	W	EMBOSSSED TYPE	
87759-3461	87759-3471	87759-3481	34	N	1	-----	33.90	32.00	---	3.20	5.90	8.10	34.50	26.20	52.40	56.00	B
87759-3462	87759-3472	87759-3482	34	N	2	-----	33.90	32.00	---	3.20	5.90	8.10	34.50	26.20	52.40	56.00	B
87759-3463	87759-3473	87759-3483	34	N	3	-----	33.90	32.00	---	3.20	5.90	8.10	34.50	26.20	52.40	56.00	B
87759-6341	87759-7341	87759-8341	34	Y	1	-----	33.90	32.00	---	3.20	5.90	8.10	34.50	26.20	52.40	56.00	B
87759-6342	87759-7342	87759-8342	34	Y	2	-----	33.90	32.00	---	3.20	5.90	8.10	34.50	26.20	52.40	56.00	B
87759-6343	87759-7343	87759-8343	34	Y	3	-----	33.90	32.00	---	3.20	5.90	8.10	34.50	26.20	52.40	56.00	B
87759-3661	87759-3671	87759-3681	36	N	1	-----	35.90	34.00	---	3.20	5.90	8.10	36.50	26.20	52.40	56.00	B
87759-3662	87759-3672	87759-3682	36	N	2	-----	35.90	34.00	---	3.20	5.90	8.10	36.50	26.20	52.40	56.00	B
87759-3663	87759-3673	87759-3683	36	N	3	-----	35.90	34.00	---	3.20	5.90	8.10	36.50	26.20	52.40	56.00	B
87759-6361	87759-7361	87759-8361	36	Y	1	-----	35.90	34.00	---	3.20	5.90	8.10	36.50	26.20	52.40	56.00	B
87759-6362	87759-7362	87759-8362	36	Y	2	-----	35.90	34.00	---	3.20	5.90	8.10	36.50	26.20	52.40	56.00	B
87759-6363	87759-7363	87759-8363	36	Y	3	-----	35.90	34.00	---	3.20	5.90	8.10	36.50	26.20	52.40	56.00	B
87759-3861	87759-3871	87759-3881	38	N	1	-----	37.90	36.00	---	3.20	5.90	8.10	38.50	26.20	52.40	56.00	B
87759-3862	87759-3872	87759-3882	38	N	2	-----	37.90	36.00	---	3.20	5.90	8.10	38.50	26.20	52.40	56.00	B
87759-3863	87759-3873	87759-3883	38	N	3	-----	37.90	36.00	---	3.20	5.90	8.10	38.50	26.20	52.40	56.00	B
87759-6381	87759-7381	87759-8381	38	Y	1	-----	37.90	36.00	---	3.20	5.90	8.10	38.50	26.20	52.40	56.00	B
87759-6382	87759-7382	87759-8382	38	Y	2	-----	37.90	36.00	---	3.20	5.90	8.10	38.50	26.20	52.40	56.00	B
87759-6383	87759-7383	87759-8383	38	Y	3	-----	37.90	36.00	---	3.20	5.90	8.10	38.50	26.20	52.40	56.00	B

B

ADD 87759-1611, 1612, 1613 EC NO: S2009-0622 DRWN:ATSEE 2009/03/19 CHKD:SKANG 2009/03/24 APPR:MLONG 2009/03/24	QUALITY SYMBOLS	GENERAL TOLERANCES (UNLESS SPECIFIED)	DIMENSION STYLE	SCALE	DESIGN UNITS	THIRD ANGLE PROJECTION
	=0 =0	mm      INCH 4 PLACES ± --- ± --- 3 PLACES ± --- ± --- 2 PLACES ± 0.2 ± --- 1 PLACE ± --- ± --- ANGULAR ± 3 °	MM ONLY DRAWN BY: SKLIM01      DATE: 2006/03/23 CHECKED BY: PATEY      DATE: 2006/03/29 APPROVED BY: PATEY      DATE: 2006/03/29	NTS	METRIC	
	DRAFT WHERE APPLICABLE MUST REMAIN WITHIN DIMENSIONS	SEE TABLE	TITLE: CUSTOM HEADER 2.00MM PITCH DUAL ROW HDR, SINGLE WAFER, SMT MOLEX INCORPORATED DOCUMENT NO. SD-87759-277 SHEET NO. 10 OF 12			
	SIZE: A3 THIS DRAWING CONTAINS INFORMATION THAT IS PROPRIETARY TO MOLEX INCORPORATED AND SHOULD NOT BE USED WITHOUT WRITTEN PERMISSION					





	10	9	8	7	6	5	4	3	2	1								
	PART NUMBER WITHOUT CAP IN TUBE	PART NUMBER WITH CAP IN TUBE	PART NUMBER WITH CAP IN TAPE & REEL	CKT SIZE	PLATING TYPE	VOID POSITION	A	B	C	M	(F)	(G)	Bo	F1	So	W	EMBOSSSED TYPE	
F	87759-4061	87759-4071	87759-4081	40	N	1	-----	39.90	38.00	---	3.20	5.90	8.10	40.50	26.20	52.40	56.00	B
	87759-4062	87759-4072	87759-4082	40	N	2	-----	39.90	38.00	---	3.20	5.90	8.10	40.50	26.20	52.40	56.00	B
	87759-4063	87759-4073	87759-4083	40	N	3	-----	39.90	38.00	---	3.20	5.90	8.10	40.50	26.20	52.40	56.00	B
	87759-6401	87759-7401	87759-8401	40	Y	1	-----	39.90	38.00	---	3.20	5.90	8.10	40.50	26.20	52.40	56.00	B
	87759-6402	87759-7402	87759-8402	40	Y	2	-----	39.90	38.00	---	3.20	5.90	8.10	40.50	26.20	52.40	56.00	B
E	87759-6403	87759-7403	87759-8403	40	Y	3	-----	39.90	38.00	---	3.20	5.90	8.10	40.50	26.20	52.40	56.00	B
	87759-4261	87759-4271	87759-4281	42	N	1	-----	41.90	40.00	---	3.20	5.90	8.10	42.50	26.20	52.40	56.00	B
	87759-4262	87759-4272	87759-4282	42	N	2	-----	41.90	40.00	---	3.20	5.90	8.10	42.50	26.20	52.40	56.00	B
	87759-4263	87759-4273	87759-4283	42	N	3	-----	41.90	40.00	---	3.20	5.90	8.10	42.50	26.20	52.40	56.00	B
	87759-6421	87759-7421	87759-8421	42	Y	1	-----	41.90	40.00	---	3.20	5.90	8.10	42.50	26.20	52.40	56.00	B
D	87759-6422	87759-7422	87759-8422	42	Y	2	-----	41.90	40.00	---	3.20	5.90	8.10	42.50	26.20	52.40	56.00	B
	87759-6423	87759-7423	87759-8423	42	Y	3	-----	41.90	40.00	---	3.20	5.90	8.10	42.50	26.20	52.40	56.00	B
	87759-4461	87759-4471	87759-4481	44	N	1	-----	43.90	42.00	---	3.20	5.90	8.10	44.50	26.20	52.40	56.00	B
	87759-4462	87759-4472	87759-4482	44	N	2	-----	43.90	42.00	---	3.20	5.90	8.10	44.50	26.20	52.40	56.00	B
	87759-4463	87759-4473	87759-4483	44	N	3	-----	43.90	42.00	---	3.20	5.90	8.10	44.50	26.20	52.40	56.00	B
	87759-6441	87759-7441	87759-8441	44	Y	1	-----	43.90	42.00	---	3.20	5.90	8.10	44.50	26.20	52.40	56.00	B
C	87759-6442	87759-7442	87759-8442	44	Y	2	-----	43.90	42.00	---	3.20	5.90	8.10	44.50	26.20	52.40	56.00	B
	87759-6443	87759-7443	87759-8443	44	Y	3	-----	43.90	42.00	---	3.20	5.90	8.10	44.50	26.20	52.40	56.00	B

B

ADD 87759-1611, 1612, 1613 EC NO: S2009-0622 DRW:AT SEE 2009/03/19 CHK:SKANG 2009/03/24 APPR:MLONG 2009/03/24	QUALITY SYMBOLS	GENERAL TOLERANCES (UNLESS SPECIFIED)	DIMENSION STYLE	SCALE	DESIGN UNITS	THIRD ANGLE PROJECTION
	= 0 = 0.2	mm      INCH 4 PLACES ± --- ± --- 3 PLACES ± --- ± --- 2 PLACES ± 0.2 ± --- 1 PLACE ± --- ± --- ANGULAR ± 3 °	MM ONLY	NTS	METRIC	
	REV	DRAFT WHERE APPLICABLE MUST REMAIN WITHIN DIMENSIONS	DRAWN BY: SKLIM01      DATE: 2006/03/23 CHECKED BY: PATEY      DATE: 2006/03/29 APPROVED BY: PATEY      DATE: 2006/03/29	TITLE: CUSTOM HEADER 2.00MM PITCH DUAL ROW HDR, SINGLE WAFER, SMT		
	B1	SEE TABLE	MATERIAL NO.      DOCUMENT NO.      SHEET NO. SEE TABLE      SD-87759-277      11 OF 12	MOLEX INCORPORATED		

10	9	8	7	6	5	4	3	2	1								
PART NUMBER WITHOUT CAP IN TUBE	PART NUMBER WITH CAP IN TUBE	PART NUMBER WITH CAP IN TAPE & REEL	CKT SIZE	PEGLATING TYPE	VOID POSITION	A	B	C	M	(F)	(G)	Bo	F1	So	W	EMBOSSSED TYPE	
87759-4661	87759-4671	87759-4681	46	N	1	-----	45.90	44.00	---	3.20	5.90	8.10	46.50	34.20	68.40	72.00	B
87759-4662	87759-4672	87759-4682	46	N	2	-----	45.90	44.00	---	3.20	5.90	8.10	46.50	34.20	68.40	72.00	B
87759-4663	87759-4673	87759-4683	46	N	3	-----	45.90	44.00	---	3.20	5.90	8.10	46.50	34.20	68.40	72.00	B
87759-6461	87759-7461	87759-8461	46	Y	1	-----	45.90	44.00	---	3.20	5.90	8.10	46.50	34.20	68.40	72.00	B
87759-6462	87759-7462	87759-8462	46	Y	2	-----	45.90	44.00	---	3.20	5.90	8.10	46.50	34.20	68.40	72.00	B
87759-6463	87759-7463	87759-8463	46	Y	3	-----	45.90	44.00	---	3.20	5.90	8.10	46.50	34.20	68.40	72.00	B
87759-4861	87759-4871	87759-4881	48	N	1	-----	47.90	46.00	---	3.20	5.90	8.10	48.50	34.20	68.40	72.00	B
87759-4862	87759-4872	87759-4882	48	N	2	-----	47.90	46.00	---	3.20	5.90	8.10	48.50	34.20	68.40	72.00	B
87759-4863	87759-4873	87759-4883	48	N	3	-----	47.90	46.00	---	3.20	5.90	8.10	48.50	34.20	68.40	72.00	B
87759-6481	87759-7481	87759-8481	48	Y	1	-----	47.90	46.00	---	3.20	5.90	8.10	48.50	34.20	68.40	72.00	B
87759-6482	87759-7482	87759-8482	48	Y	2	-----	47.90	46.00	---	3.20	5.90	8.10	48.50	34.20	68.40	72.00	B
87759-6483	87759-7483	87759-8483	48	Y	3	-----	47.90	46.00	---	3.20	5.90	8.10	48.50	34.20	68.40	72.00	B
87759-5061	87759-5071	87759-5081	50	N	1	-----	49.90	48.00	---	3.20	5.90	8.10	50.50	34.20	68.40	72.00	B
87759-5062	87759-5072	87759-5082	50	N	2	-----	49.90	48.00	---	3.20	5.90	8.10	50.50	34.20	68.40	72.00	B
87759-5063	87759-5073	87759-5083	50	N	3	-----	49.90	48.00	---	3.20	5.90	8.10	50.50	34.20	68.40	72.00	B
87759-6501	87759-7501	87759-8501	50	Y	1	-----	49.90	48.00	---	3.20	5.90	8.10	50.50	34.20	68.40	72.00	B
87759-6502	87759-7502	87759-8502	50	Y	2	-----	49.90	48.00	---	3.20	5.90	8.10	50.50	34.20	68.40	72.00	B
87759-6503	87759-7503	87759-8503	50	Y	3	-----	49.90	48.00	---	3.20	5.90	8.10	50.50	34.20	68.40	72.00	B

B

<b>ADD 87759-1611, 1612, 1613</b> EC NO: S2009-0622 DRWN:ATSEE 2009/03/19 CHKD:SKANG 2009/03/24 APPR:MLONG 2009/03/24	QUALITY SYMBOLS  = 0  = 0.2	GENERAL TOLERANCES (UNLESS SPECIFIED)	DIMENSION STYLE <b>MM ONLY</b>	SCALE <b>NTS</b>	DESIGN UNITS <b>METRIC</b>	 <b>THIRD ANGLE PROJECTION</b>
		4 PLACES ± --- ± --- 3 PLACES ± --- ± --- 2 PLACES ± 0.2 ± --- 1 PLACE ± --- ± --- ANGULAR ± 3 °	DRAWN BY SKLIM01 DATE 2006/03/23 CHECKED BY PATEY DATE 2006/03/29 APPROVED BY PATEY DATE 2006/03/29	TITLE <b>CUSTOM HEADER          2.00MM PITCH DUAL ROW          HDR, SINGLE WAFER, SMT</b>		
		DRAFT WHERE APPLICABLE MUST REMAIN WITHIN DIMENSIONS	MATERIAL NO. <b>SEE TABLE</b>	 <b>MOLEX INCORPORATED</b> DOCUMENT NO. <b>SD-87759-277</b>		
		SIZE <b>A3</b>	THIS DRAWING CONTAINS INFORMATION THAT IS PROPRIETARY TO MOLEX INCORPORATED AND SHOULD NOT BE USED WITHOUT WRITTEN PERMISSION	SHEET NO. <b>12 OF 12</b>		