

*Operating Manual*  
**RBK- ILS Processor MK3**  
**PN529535-1**

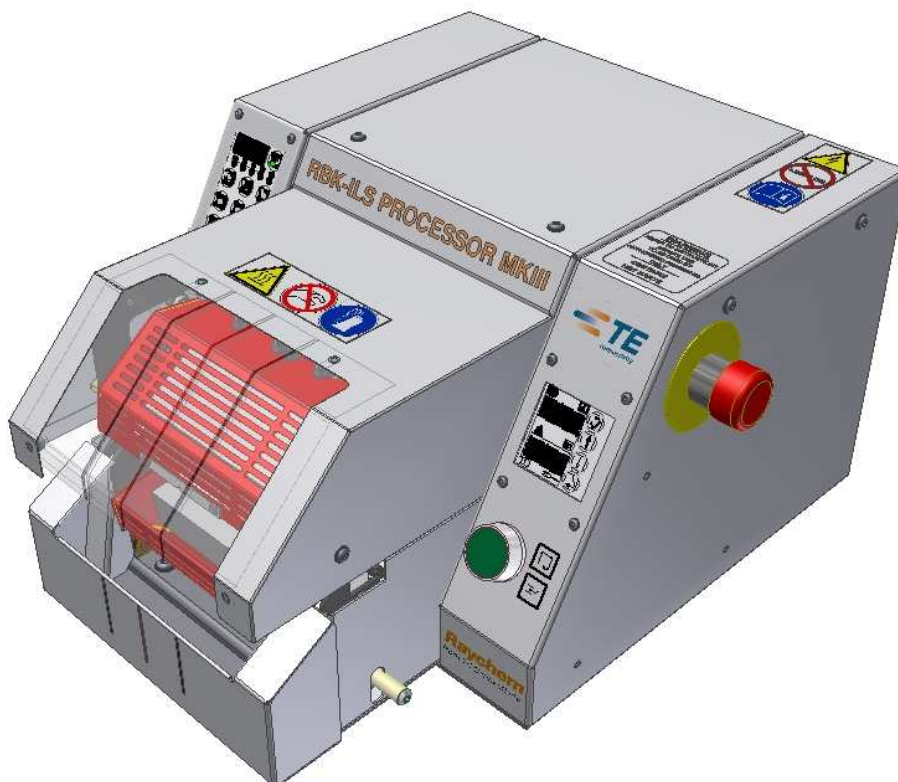

**Operation and Maintenance Manual**



**Tyco Electronics AMP GmbH**  
**Ampèrestraße 12-14**  
**64625 Bensheim**  
**+49-6251-133-0**  
**+49-6251-133-1600**

**<http://www.te.com/europe>**

**Tyco Electronics AMP GmbH**  
**a TE Connectivity Ltd. Company.**



***RBK-ILS and RAYCHEM are trademarks of TE/Tyco Electronics.***

***All of the information in this manual, including illustrations, is believed to be reliable. Users, however, should independently evaluate the suitability of each product for their application.***

***TE Connectivity /Tyco Electronics/Raychem make no warranties as to the accuracy or completeness of the information and disclaim any liability regarding its use.***

***TE Connectivity /Tyco Electronics/Raychem only obligations are those in the Standard Terms and Conditions of Sale for this product and in no case will TE Connectivity/Tyco Electronics/Raychem be liable for any incidental, indirect or consequential damages arising from the sale, resale, use or misuse of the product.***

***TE Connectivity/Tyco/Raychem Specifications are subject to change without notice. In addition TE Connectivity /Tyco Electronics reserve the right to make changes in materials or processing, without notification to Buyer, which do not affect compliance with any applicable specification.***

***TE/Tyco Electronics 2013. No part of this manual may be reproduced or transmitted in any form or by any means, electronic or mechanical, including photocopying, or recorded by any information storage or retrieval system, without written permission from TE/Tyco.***

***The original operating manual has been written in English.***

**Disposal: RBK- ILS Processor MK3**



***This product must not be disposed of as municipal waste.***

**RoHS: RBK- ILS Processor MK3**



**ROHS Information**

***TE Connectivity/Tyco Electronics only produces products in conformity with RoHS.***

***Information on the occurrence and location of substances subject to RoHS guidelines (Restriction on Hazardous Substances) can be found at the following website:***

***<http://www.te.com/customersupport/productcompliance/>***

**Amendment Record**

Issue No.	Content	Amended By	Date	Change Request No.
<i>Issue A</i>	<i>Complete Manual</i>		<i>May 2013</i>	
<i>Issue A1</i>	<i>One chapter removed</i>	<i>Lipp</i>	<i>June 2013</i>	
<i>Issue A2</i>	<i>Adjustment of spare part PNs</i>	<i>Lipp</i>	<i>August 2013</i>	
<i>Issue A3</i>	<i>Picture on page 1-8 replaced</i>	<i>Lipp</i>	<i>October 2013</i>	

# Table of Contents

<b>1.</b>	<b>Introduction.....</b>	<b>1-1</b>
<b>1.1</b>	<b>About this Manual .....</b>	<b>1-1</b>
<b>1.2</b>	<b>General Information .....</b>	<b>1-2</b>
<b>1.2.1</b>	<b>Front Panel.....</b>	<b>1-3</b>
<b>1.2.2</b>	<b>Temperature Display Panel .....</b>	<b>1-4</b>
<b>1.2.3</b>	<b>Process Time Display Panel.....</b>	<b>1-5</b>
<b>1.2.4</b>	<b>Rear Panel .....</b>	<b>1-6</b>
<b>1.2.5</b>	<b>Air Cooled Stub splice fixture. PN - 981721-000 .....</b>	<b>1-8</b>
<b>2.</b>	<b>Safety.....</b>	<b>2-1</b>
<b>2.1</b>	<b>General Warnings.....</b>	<b>2-1</b>
<b>2.2</b>	<b>Electrical Safety.....</b>	<b>2-2</b>
<b>2.3</b>	<b>Personal Safety.....</b>	<b>2-3</b>
<b>2.3.1</b>	<b>Eyes .....</b>	<b>2-3</b>
<b>2.3.2</b>	<b>Clothing .....</b>	<b>2-3</b>
<b>2.3.3</b>	<b>Fire Hazard .....</b>	<b>2-3</b>
<b>2.3.4</b>	<b>Hot Surfaces .....</b>	<b>2-3</b>
<b>2.3.5</b>	<b>Servicing .....</b>	<b>2-3</b>
<b>2.4</b>	<b>Warnings and Labels .....</b>	<b>2-4</b>
<b>2.4.1</b>	<b>Important Symbols .....</b>	<b>2-5</b>
<b>3.</b>	<b>Installation and Operation .....</b>	<b>3-1</b>
<b>3.1</b>	<b>Installation.....</b>	<b>3-1</b>
<b>3.1.1</b>	<b>Unpacking .....</b>	<b>3-1</b>
<b>3.1.2</b>	<b>Safety .....</b>	<b>3-1</b>
<b>3.1.3</b>	<b>Location .....</b>	<b>3-1</b>
<b>3.1.4</b>	<b>Electrical Connections.....</b>	<b>3-1</b>
<b>3.2</b>	<b>Operation.....</b>	<b>3-2</b>
<b>3.2.1</b>	<b>Safety .....</b>	<b>3-2</b>
<b>3.2.2</b>	<b>Controls and Indications .....</b>	<b>3-2</b>
<b>3.2.3</b>	<b>Processor States .....</b>	<b>3-2</b>
<b>3.2.4</b>	<b>Stand-by .....</b>	<b>3-2</b>
<b>3.2.5</b>	<b>Operating Modes .....</b>	<b>3-2</b>
<b>3.2.6</b>	<b>Local Operating Mode.....</b>	<b>3-2</b>
<b>3.2.7</b>	<b>Sequenced Operation .....</b>	<b>3-3</b>
<b>3.2.8</b>	<b>Remote Operation .....</b>	<b>3-3</b>
<b>3.2.9</b>	<b>Initial Switch On.....</b>	<b>3-3</b>
<b>3.2.10</b>	<b>OPERATING CYCLE .....</b>	<b>3-5</b>

3.2.11	Switching Off .....	3-6
3.2.12	Emergency Stop .....	3-6
3.2.13	Emergency Heater Chamber Release.....	3-8
3.2.14	Heater Carriage Jammed .....	3-9
3.2.15	Operator .....	3-10
3.2.16	Fault Indications .....	3-11
3.2.17	Routine Maintenance .....	3-12
4.	Service and Repair .....	4-1
4.1	Processor Parameters .....	4-1
4.1.1	Selecting Processor Parameters .....	4-1
4.1.2	Password Selection.....	4-2
4.1.3	RBK- ILS Processor MK3 Parameters .....	4-3
4.2	Defining Operating Modes.....	4-5
4.2.1	Local Operating Mode.....	4-5
4.2.2	Sequenced Mode .....	4-5
4.2.3	Selecting and Operating the Sequenced M .....	4-5
4.2.4	Remote Operating Mode.....	4-6
4.2.5	RS232 Data Format.....	4-7
4.2.6	Keypad Lock Mode.....	4-8
4.3	Calibration.....	4-9
4.3.1	Automatic Calibration Procedure .....	4-9
4.3.2	Manual Calibration Procedure .....	4-12
4.4	Gaining Access.....	4-13
4.5	Troubleshooting .....	4-15
4.5.1	Fault Analysis .....	4-15
4.5.2	Preliminary Checks .....	4-16
4.5.3	Abbreviations.....	4-16
4.5.4	Troubleshooting Table.....	4-16
4.6	Repair.....	4-22
4.6.1	Circuit Protection Devices.....	4-22
4.6.2	External .....	4-22
4.6.3	Internal .....	4-22
4.6.4	Heater Element Replacement.....	4-23
4.6.5	Upper Element .....	4-23
4.6.6	Lower Element.....	4-25
4.6.7	Load (Front) Proximity Sensor Adjustment.....	4-27
4.6.8	Home (Rear) Proximity Switch .....	4-27
4.6.9	Proximity Switch Replacement .....	4-28
4.6.10	Motor Assembly Replacement.....	4-28
4.6.11	Motor Removal.....	4-29

4.6.12	<b>Motor Assemble Fitting</b> .....	4-30
4.6.13	<b>Cooling Fan Replacement</b> .....	4-32
4.6.14	<b>24V DC Power Supply Replacement/Motor PSU Assembly</b> .....	4-33
4.6.15	<b>Generic Controller PCB/EPROM Replacement</b> .....	4-34
4.6.16	<b>GC PCB EPROM Replacement</b> .....	4-35
4.6.17	<b>Thermocouple Compensating Cable Replacement</b> .....	4-36
4.6.18	<b>Power Switching PCB Replacement</b> .....	4-37
4.6.19	<b>Isolation Relay Replacement</b> .....	4-38
4.6.20	<b>Solid State Isolator Replacement</b> .....	4-38
4.6.21	<b>Mains Filter Replacement</b> .....	4-38
4.6.22	<b>Temperature Display Panel Replacement</b> .....	4-39
4.6.23	<b>Process Time Display Panel Replacement</b> .....	4-40
4.7	<b>Maintenance</b> .....	4-41
4.7.1	<b>Electrical Safety Checks</b> .....	4-41
4.7.2	<b>Maintenance</b> .....	4-43
4.7.3	<b>Temperature Calibration</b> .....	4-43
4.8	<b>Recommended Spares</b> .....	4-44
4.8.1	<b>Supplier- web-sites</b> .....	4-50
5.	<b>Technical Details</b> .....	5-1
5.1	<b>Specification</b> .....	5-1
6.	<b>Address "After" Sales</b> .....	6-1

# 1. Introduction

## 1.1 About this Manual

*This manual contains full information about the RBK- ILS Processor MK3 and comprises 6 sections:*

### **Section 1 - Introduction**

*This section contains general information regarding the RBK- ILS Processor MK3.*

### **Section 2 – Safety**

*This section contains important safety information and details of equipment labelling.*

### **Section 3 - Installation and Operation**

*Describes how to unpack, install and operate the equipment and information on how to look after it.*

### **Section 4 - Service and Repair**

*This section contains details of setting the operating parameters, troubleshooting, repair and full maintenance information with details of recommended spares and technical support.*

### **Section 5 - Technical Details**

*This section contains a technical specification and standards compliance information.*

### **Section 6 - Wiring Diagrams**

*This section contains detailed internal wiring diagrams of the equipment.*

#### **Note:**

You do not need to read the whole document in order to install and operate the equipment but you should read and understand the whole of this introduction, Section 2 - Safety and Section 3 - Installation and Operation.

## 1.2 General Information

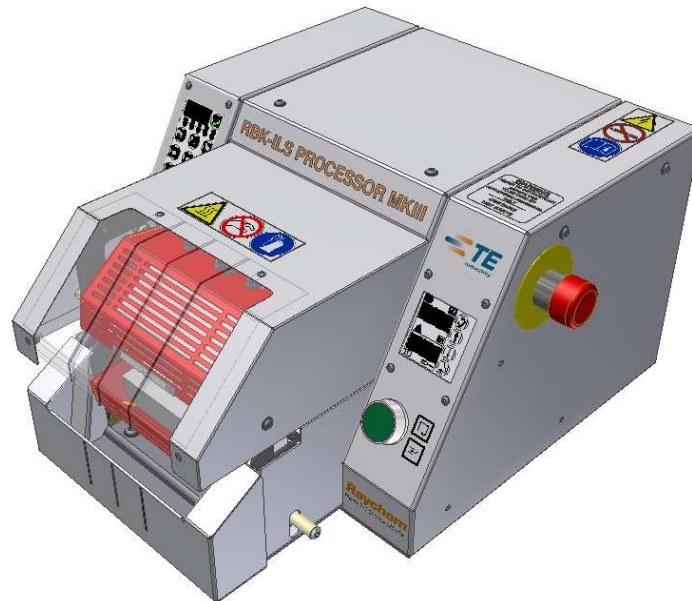

Fig. 1-1: General View

The RBK- ILS Processor MK3 is semi-automatic units using an infrared process to heat shrink Tyco Electronics ILS-125, ILS-85 and QSZH products onto ultrasonically welded or crimped splices.

The equipment is designed to operate in conjunction with ultrasonic welders, positioned adjacent to the welding head.

The heat chamber takes ILS and QSZH products from size 1 to 3A and has electrically heated quartz glass elements which provide the heat source, up to 600°C<sup>1</sup>. Operation of the chamber is prevented until its temperature is within 10°C of the set operating temperature.

Activated by two start buttons, the heating chamber moves forward, enclosing the joint area. It remains in place for the set timed period, and then returns to the rear rest position, automatically ejecting the wire assembly with the RBK-ILS splice sealing product installed.

In the event of a power failure the heating chamber is retracted to the rear rest position.

The RS232 interface, allows Time, Temperature and Product size to be transferred from a remote machine (e.g. ultrasonic welding equipment) or control computer.

Fifteen pre-set memory buttons can be programmed for local storage of Time, Temperature and Product size. These can be selected individually by the operator, or selected in a set sequence.

*Note:* 500°C is the maximum recommended set temperature.

### ACCESSORIES:

**RBK-ILS-Proc-STUP-SP-FX:** Used for installing stub splice tubing's.

The Air Cooled stub splice fixture is used in conjunction with RBK-ILS-Proc-Air-Cool-Kit.

**RBK-ILS-PROC-TERMFIX-08MM** 8mm ring terminal fixture that can be fitted to the RBK-ILS-Proc-Air-Cool-Kit: to install 8mm ring terminals.

Calibration tools required to Auto – calibrate the RBK- ILS Processor MK3.

CLT-Equip-UHI-250A-1-PRB	288869-000	Standard UHI temperature calibration probe
CLTEQ-UHI250-EXT-CABL	952687-000	Extension cable



## Controls and Major Components

### 1.2.1 Front Panel

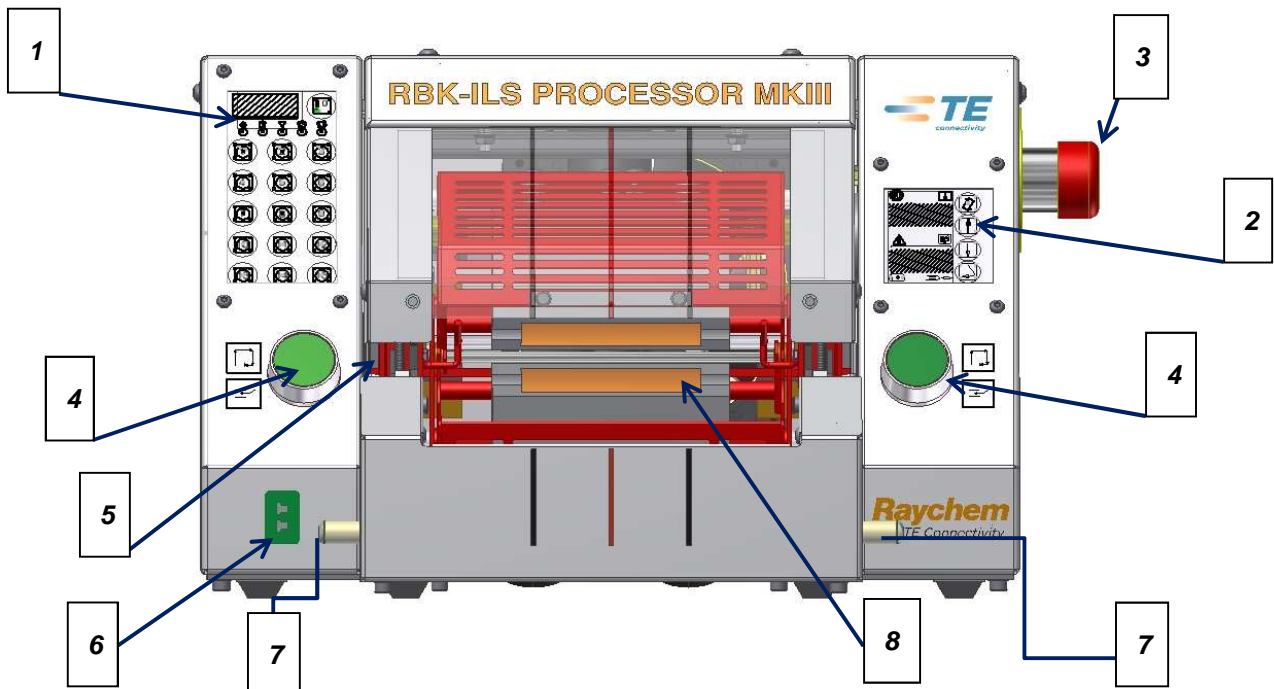

Fig. 1-2: Controls and Features - Front Panel

1. **Temperature Display Panel**  
(Allows process selection using the 15 pre-programmed buttons, provides five Processor condition indicators and presents the actual heater chamber temperature.)
2. **Process Timer Display Panel**  
(Indicates process time and temperature; product size and process. Four buttons allow parameter selection)
3. **Emergency Stop**  
(cuts power to machine)
4. **Cycle Start Push buttons**  
(both buttons to be pressed simultaneously)
5. **Grippers**  
(hold cable splice in heating chamber)
6. **Calibration Socket**  
(allows connection of the UHI temperature probe for Processor calibration)
7. **Dual Release**  
(allow removal of splice by hand)
8. **Heater Chamber**  
(heat shrinks product over splice)

## 1.2.2 Temperature Display Panel

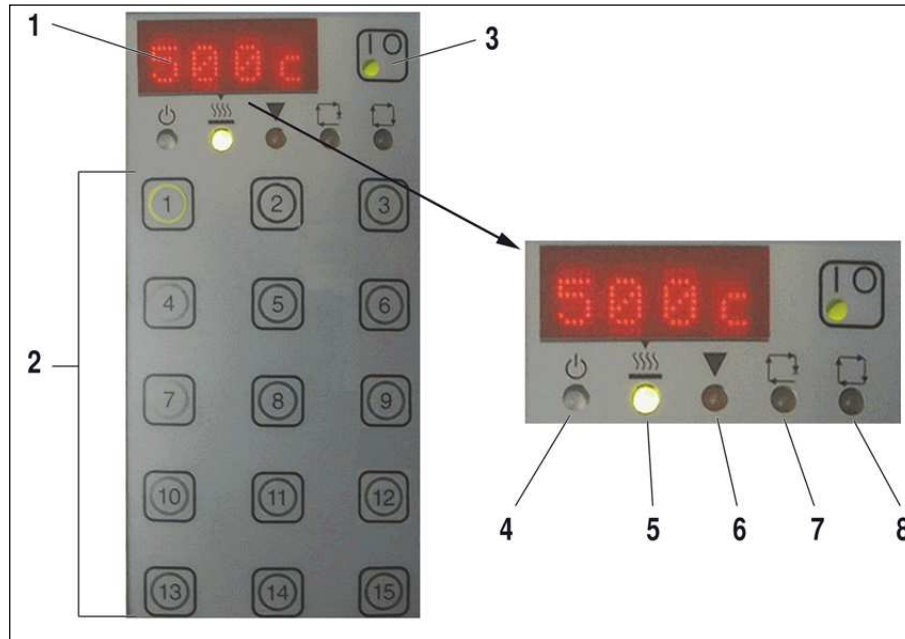

Fig. 1-3: Temperature Display Panel Features

1. **Displays actual Heater Chamber Temperature and fault indications** (↑ when warming up, ↓ when cooling down).
2. **Power I/O Switch. Illuminated (Green) when ON. Flashes when cooling fan is off and when warming up.**
3. **Process Selection Buttons (15). Illuminated when selected.**
4. **Power Indicator (Blue). ON when Processor is in stand-by. Flashes during cooling to stand-by**
5. **Heater Chamber Indicator (Yellow – warming up; Green – OK; Red – heater fault).**
6. **Calibrate Indicator (Amber). Flashing – Processor calibration required. Steady – calibration mode selected.**
7. **Cycle Indication (Amber). Steady – heater chamber is forward and a timed process is being carried out. Flashing – heater chamber movement fault.**
8. **Sequence Indicator (Amber) Indicates that a sequenced process is selected.**

### 1.2.3 Process Time Display Panel

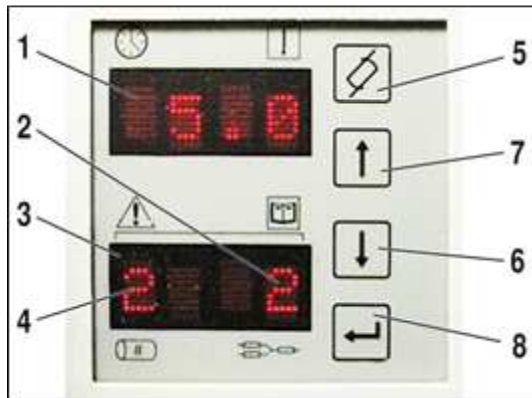

Fig. 1-4: Process Time Display Panel

1. **Selected Process and Set Time/Temperature Display** (Displays parameter values in adjustment mode.)
2. **Process Selection Display** (Displays parameter names in adjustment mode.)
3. **Product size.** (Displayed on first 2 digits)
4. **Selected Process Button Number.** (Displayed on last 2 digits)
5. **SELECT Button**
  - a) Selects time/temperature and Processor cycle hour's information.
  - b) Selects parameter adjustment mode (used with ENTER button).
  - c) Selects required digit when adjusting Processor parameters.
6. **UP Selection Button**
  - a) Steps up through process 1 to 15.
  - b) Increases the value of the selected digit.
7. **DOWN Selection Button**
  - a) Steps down through process 15 to 1.
  - b) Decreases the value of the selected digit.
8. **ENTER Button**
  - a) Selects parameter adjustment mode (used with SELECT button).
  - b) Stores the adjusted parameter.
  - c) Operate for 3 seconds to exit parameter adjustment mode.

## 1.2.4 Rear Panel

Fig. 1-5: Controls and Features -Rear Panel



1. **FAN Fuse**  
(240V, 100mA anti-surge)
2. **HEATER Fuse**  
(240V d.c. 2A anti-surge)
3. **Mains Isolation Switch** (used to turn off power to the Processor, when in Stand-by Mode).



**Do not use the Mains Isolation switch (3) to turn off the Processor, as this will cause a significant reduction to the life of the heater element. Turn off the Heater using the I/O Switch (2) on the Temperature Display Panel. (See Figure 1.3.). The temperature will drop and cooling will continue, once below 200° C, the fan will turn off and the Processor will enter the stand-by mode. The power can now be switched off using the Mains Isolation Switch.**

4. **Power Input Socket**  
(220/240V, 50Hz)
5. **Mains Fuses**  
(2 x 240V, 3.15A anti-surge)
6. **Cooling Fan**  
(operates above 200°C heater temperature)
7. **Air Cooling Socket.**
8. **"0" volts output (n/c and n/o)**
9. **RS232 Connector**

**EMC Protection for connecting external devices to the MK3 Processor.**

**Connecting any external device to the following outputs below a ferrite core must be clamped to every connection used. The ferrite clamp must contain one loop.**

**Ferrite Type 742 712 22/WÜRTH**

**Connection requiring ferrite clamp WITH ONE LOOP.**

**7. Air Cooling**

**8. "O" Volts output (n/c and n/o)**

**9. RS232 connector**



**1 x ferrite core to every connection on the interfaces "one loop" as shown...**



742 712 22

### 1.2.5 Air Cooled Stub splice fixture. PN - 981721-000.

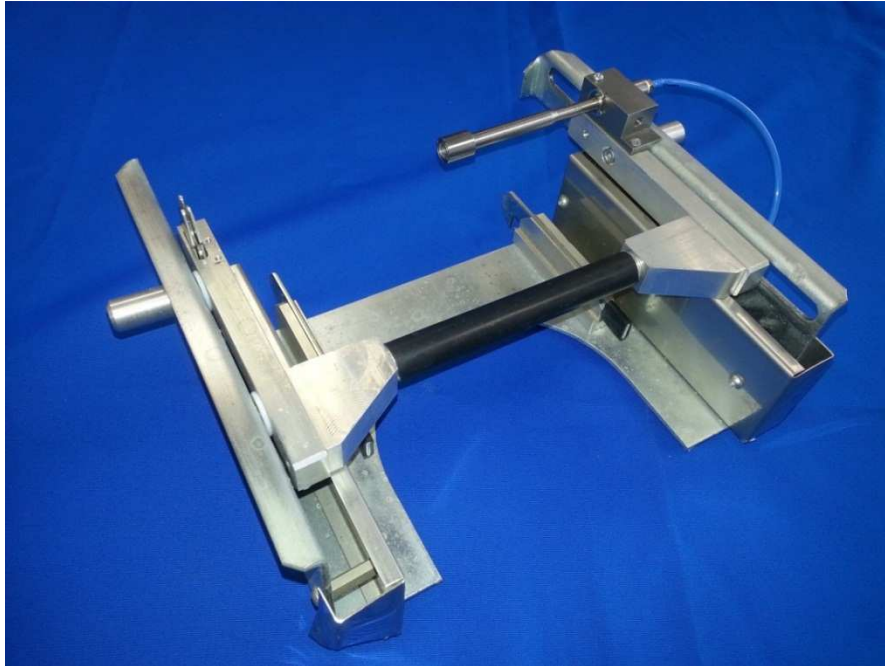

The Stub Splice Fixture is an accessory designed for use with the RBK- ILS Processor MK3 and is suitable for the installation of TE/Tyco/ Raychem stub splice sealing products. It is also suitable, provided that the appropriate tooling set is fitted, for use in installing heat shrinkable tubing onto ring terminals for both insulation and sealing.

By removing the front guard the fixture may be fitted to any RBK- ILS Processor MK3. An adaptor plate is supplied with the fixture which should be permanently fitted to the RBK- ILS Processor MK3. The adaptor plate provides a quick release feature and once fitted allows 'instantaneous' assembly and removal of the fixture from the machine. The Air Cooled stub splice fixture is used in conjunction with RBK- ILS-Proc-Air-Cool-Kit.

The fixture is supplied with quick release tooling sets for use with stub splices. Tooling sets for ring terminals and other applications must be ordered separately.

The fixture should be fitted to the machine whenever the need arises to process stub splices or ring terminals. Once the fixture is in position the heat- shrinkable product should be assembled to the work piece and the work piece located into the tooling fixture. The work piece can then be moved forward into the correct position by the operator and once in position the machine cycle can be initiated

At the end of the heating cycle the work piece is automatically returned to the loading position where it may be removed by the operator. The fixture should be removed from the machine whenever in-line splices are being processed. Fit the front safety guard before use for inline splices.

RBK-ILS-Proc-Air-Cool-Kit PN 1-529533-7



## 2. Safety

In common with all electrical equipment, the RBK- ILS Processor MK3 must be used in accordance with established safe working practices.

Prior to using the equipment, carefully read the Installation and Operating instructions (Section 3), together with the following safety warnings.

### 2.1 General Warnings



*Incorrect use of this equipment may cause injury.*

*This equipment must be operated and maintained only by fully trained and qualified personnel.*

*Do not leave the equipment unattended during the process cycle.*

Jamming of the operating mechanism may prevent the auto retraction of the heater chamber. In this event the RBK processor heaters will switch off automatically. Follow “Heater Carriage Jammed 3.2.14 page 3-10 and the Emergency Heater Chamber Release” on page 3-9

*Failure to follow the manufacturer’s instructions may affect the equipment warranty.*

*Do not use the equipment for cooking food or heating products other than those recommended by TE/Tyco Electronics.*

*Do not operate the Processor near combustible liquids or gasses.*

*Ensure adequate ventilation around the cooling fan intake and output grills a minimum of 75mm clear space, when the equipment is in use.*

## 2.2 Electrical Safety

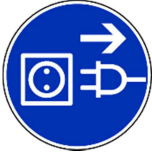

*The equipment is connected to an AC mains electricity supply. Before undertaking any maintenance or repair, always turn off the equipment and ensure it is isolated from the AC supply.*

*Allow the equipment to cool.*

***Electrical safety checks are described in 4.7. DO NOT CARRY OUT AN INSULATION RESISTANCE CHECK USING A PORTABLE APPLIANCE TEST UNIT AS THIS WILL RESULT IN DAMAGE TO THE EQUIPMENT.***

***FLASH TESTING - Do NOT Flash Test (protection circuits fitted to this equipment may be damaged)...***

***INSULATION RESISTANCE TESTING - Do NOT exceed 250V DC (protection circuits fitted to this equipment may be damaged).***

***Power connections for the Processor must conform to local standards and regulations.***

***UK installations must be fitted with a 13A plug conforming to BS1363 (Green/Yellow-Earth; Blue-Neutral; Brown-Line), containing a 5A fuse to BS1362.***

***Potentially hazardous voltages will be exposed if the equipment's panels are removed while it is powered-up. Do not use the equipment unless all external panels are securely in place.***

***The equipment input supply has double pole fusing (Line & Neutral) and must be connected to an earthed power supply. The power supply must be protected by a 30mA residual current device.***

***Use only specified fuse types and ratings.***



## 2.3 Personal Safety

### 2.3.1 Eyes



***Eye protection must be worn at all times when the tool is in use.***

### 2.3.2 Clothing



***Care must be taken to ensure hair or loose clothing does not come into contact with the Processor.***

### 2.3.3 Fire Hazard



***Parts of the tool will be hot during use. Special care must be taken to avoid heating materials other than the pieces being worked on.***

### 2.3.4 Hot Surfaces



***Do not touch the Processors heating chamber - during use, it will become extremely hot.***

***Special care must be taken when handling finished wiring assemblies immediately after ejection from the heating chamber.***



***Special care must be taken when handling the calibration UHI probe immediately after ejection from the heating chamber.***

***It is recommended that protective clothing and gloves are used when operating this tool***

### 2.3.5 Servicing

***When carrying out repairs, always follow the instructions contained in this manual or contact Tyco Electronics for further advice. A record should be kept of the maintenance and servicing of the equipment.***

***Do not use substitute components, use only TE/Tyco Electronics approved parts. If the mains (utility) power supply cord is damaged it must be replaced only by a special cord or assembly available from the supplier or its agent.***

## 2.4 Warnings and Labels

The RBK- ILS Processor MK3 carries a label (shown below) which displays the product part number (PCN), product description, electrical rating information.



The following conventions are used in the manual.















Information to prevent personal injury.







Information to prevent damage to the equipment.

## 2.4.1 Important Symbols

The following graphic symbols are used on the RBK- ILS Processor MK3.

	<b>Stand-by Indicator</b>		<b>Heater</b>
	<b>Calibration</b>		<b>Process Cycle</b>
	<b>Sequenced Process</b>		<b>Process Interrupt</b>
	<b>Time</b>		<b>Temperature</b>
	<b>Fault Code</b>		<b>Read Manual for Code Function</b>
	<b>Product size</b>		<b>Process Button Number</b>

Symbols used for parameter selection buttons.

	<b>Function Select</b>		<b>Increment Selection</b>
	<b>Decrease Selection</b>		<b>ENTER Store Selection</b>

## 3. Installation and Operation

### 3.1 Installation

#### 3.1.1 Unpacking

*Remove the RBK- ILS Processor MK3 from its packing. If there is any sign of damage, return the equipment to TE/Tyco Electronics in its original container.*

**Note:**

*The Serial Number on machine must correspond with the Serial Number on the packaging.*

#### 3.1.2 Safety



*RBK- ILS Processor MK3 must be installed in accordance with established safe working practices. Incorrect use can cause injury.*

*Installation requirements must conform to local regulations.*

#### 3.1.3 Location



*RBK- ILS Processor MK3 is designed to be installed and operated in industrial environments. However it should not be used near explosive or flammable materials or in a location where it would be subject to moisture.*

*The Processor is a manually operated device and should be sited on a flat level surface, at a height suitable for an operator - a sturdy workbench is ideal.*

*Take care to ensure that the ventilation fan on the back panel is not obstructed.*

#### 3.1.4 Electrical Connections



*The Processor is designed for operation from a 230V 50Hz mains supply and is supplied with a 2 meter power with an IEC connector. UK installations must be fitted with a 13A plug conforming to BS1363 (Green/Yellow-Earth; Blue-Neutral; Brown-Line), containing a 5A fuse to BS1362.*



*Power connections for the machine must conform to local standards and regulations.*

*The mains supply to the equipment must be protected by 30mA residual current device.*

## 3.2 Operation

### 3.2.1 Safety

**Note:**

**Before any operation is carried out using the RBK- ILS Processor MK3, ensure that the Safety Instructions contained in Chapter 2 of this manual, have been read and are fully understood.**



**The RBK- ILS Processor MK3 must be operated in accordance with safe working practices.**

**Operators must not put their hands near the heating chamber...**

**Hair or loose clothing must not come in contact with the machine.**

**Wear safety glasses at all times.**

### 3.2.2 Controls and Indications

**Details of the Processor controls can be found in Chapter 1 Figure 1.2. To Figure 1.5. Where appropriate the controls and indications are further described in the following procedures.**

### 3.2.3 Processor States

**Note:**

**The term 'process' is used within this manual to describe the application of a RBK-ILS splice sealing product, onto a cable assembly.**

### 3.2.4 Stand-by



**In stand-by, no power is connected to the heater, fan and motor circuits. The blue Stand-by LED is ON, the Processor is ready to power up. A flashing LED indicates that the Processor is cooling down and will switch to Stand-by when the chamber temperature drops below 190°C.**

### 3.2.5 Operating Modes

**The Processor can be configured in one of the following operating modes, which define the actions of the pre-set selection buttons available to the operator. Operation of the processor is similar for each mode. Further information can be found in Section 4.2.**

### 3.2.6 Local Operating Mode



**[off ]**

**The process selection button parameters (time; temperature; product size) have been assigned and stored in memory. The selected process button will be illuminated and can be used repetitively until the next is selected from either the off Temperature or Process Time Display panels. During the process the Amber Cycle LED will be lit.**

### 3.2.7 Sequenced Operation



**[on]**

The process selection button parameters have been set and programmed to step through a required sequence. On completion of the current process the selection button will change to the next in the preset sequence (from 2 to 15). The position within the process sequence can be altered by re-selecting the required process button from the Temperature Display Panel.

### 3.2.8 Remote Operation

Process conditions are received through the RS232 Interface socket. The Temperature Display Panel is disabled. A moving arrow on the Process Time Display Panel lower display 10.0 indicates that the transmitted process has been received and operator action is required. 3A identified.

1 0 . 0  
-----  
3 A ←←

During the process the arrow will be out until the next process is transmitted.

### 3.2.9 Initial Switch On

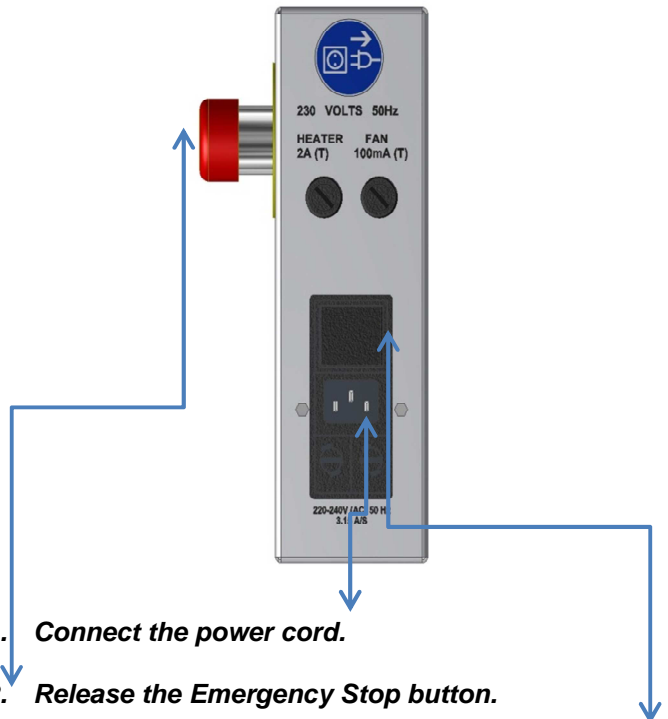
- 
1. Connect the power cord.
  2. Release the Emergency Stop button.
  3. Switch the rear panel Mains Isolation Switch to 'I'...
    - a) Check that the Blue Stand-by LED on the Temperature Display Panel is ON.
    - b) The software issue and revision number will be displayed briefly, on the Process Time Display Panel.
  4. Switch on the Processor by pressing the I/O Start/Stop Switch for three seconds.
    - a) The green LED in the button will flash.
    - b) The Processor will initiate.
  5. Check that the correct process button is selected for the task required.
    - a) The active button has a green illuminated circle.

The selected process button may also be changed from the Process Time Display Panel.

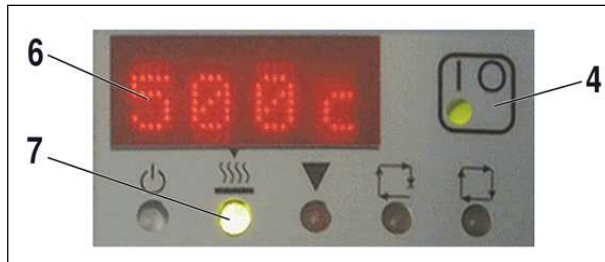

6. The actual chamber temperature will be indicated, and will increase towards the process temperature.
7. The Heater LED will indicate Yellow while the temperature is outside the alarm bands.
  - a) When the process temperature is reached the LED will indicate green.

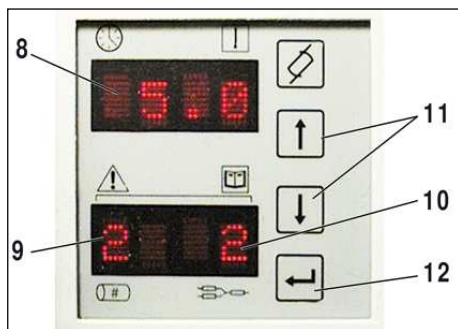

8. The Process Time Display Panel will indicate the set process temperature when outside the alarm bands, and once within the alarm bands the display will change to time.
  - a) The selected process time display will change to selected temperature if the function select button is pressed once.
9. The Product size will be shown in the first two digits of the lower display.
10. The number of the active process button (1 to 15) will be displayed in the last two digits of the display.
11. To change the active selection button from the Timer panel increment the number of the process button using the UP or DOWN arrow keys.
12. Store the selection by pressing the ENTER key.

**Note:**

Ensure that the Processor has been at operating temperature for 30 minutes prior to performing an operating cycle...

The MK3 RBK-ILS Processor is now ready to operate.

### 3.2.10 OPERATING CYCLE



Action of the Process Start buttons is inhibited until the heater LED has changed to green.

Operation of any individual Start button during the timer count-down will manually override the process and move the heater chamber to the rear.

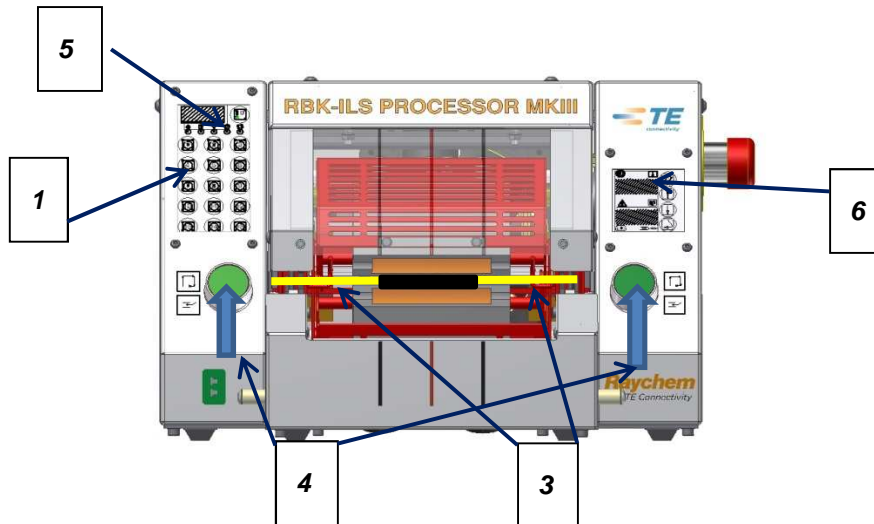

Fig. 3-1: Initiating the Operating Cycle

1

1. Check correct process button has been selected for the cable assembly to be processed.

**Note:** This will be selected automatically if the Processor is being controlled remotely.

2. Select the correct size (ILS. / QSZH) product (Code 1; 2; 3; 3A) and position over splice to be processed.

3. Insert the cable assembly into the Processor grippers.  
Align the centre of the splice and product ends, with the guide markers on the Perspex shield and Guard.

4. Press and release both START CYCLE buttons simultaneously when the heater carrier reaches front position.



5. Check that the process Cycle LED illuminates.

6. Check that the Timer Display counts down.

7. When the Timer reaches zero, the heater will move to the rear and the processed splice will be ejected.



**TAKE CARE WHEN HANDLING THE EJECTED CABLE SPLICE AS IT WILL BE HOT.**



Repeat the same operation or change to the next process button as required.

**Note:**

If the Processor has been configured to operate in the Sequential Mode the sequence LED will be lit and it will step to the next process selection button automatically after each cycle is completed.



### 3.2.11 Switching Off



*Failure to use the following method will reduce Heater life.*

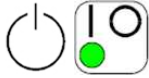

1. *Ensure that the Processor operating cycle is completed and the cable splice has been removed.*
2. *Press the Start/Stop Switch on the Temperature Display Panel for three seconds.*
  - a) *The blue Stand-by LED will flash.*
  - b) *The actual chamber temperature indication will decrease.*
  - c) *The process button will be de-selected.*
  - d) *The right timer display will switch off.*
3. *Wait until the Temperature on the display falls to 190°C.*
  - a) *At this point the display will switch off...*
  - b) *The Blue Stand-by LED will stop flashing, indicating that the Processor is now in the Stand-by mode.*
  - c) *The green LED in the Mains Isolation Switch will be OFF.*
  - d) *The cooling fan will turn off.*
4. *Switch the rear panel ON/OFF switch to 0.*
  - a) *The blue Stand-by LED will go out.*

### 3.2.12 Emergency Stop

**Note:**

*This is an EMERGENCY procedure used in the unlikely event of the Heater Chamber remaining closed after the set time sequence.*



#### **HAZARDS FROM DAMAGED PRODUCT**

*Due to the nature of all heating tools, any product which is trapped or inadvertently left in the oven can become damaged or even BURN. This may lead to smoke; hence the machine must be used in a well-ventilated area.*

*If a fire occurs inside the heater the operator should actuate the machine's Emergency Stop button and then either extinguish the fire by correct use of a CO2 filled fire extinguisher, or allow the fire to extinguish naturally. In both cases care should be taken not to inhale any of the fumes which result from the burning wires or splice tubing. If the heater chamber is forward when the STOP is activated it will immediately move to the rear and eject the splice being processed. Care should be taken in handling the splice as the splice nugget and surrounding area may be hot. The splice/wires should then be safely disposed of in a metal bin which contains no combustible material.*

*In the unlikely event the heater chamber does not retract during an emergency stop operation, follow the "Emergency Heater Chamber Release" on page 3-8.*

### Activating the Emergency Stop

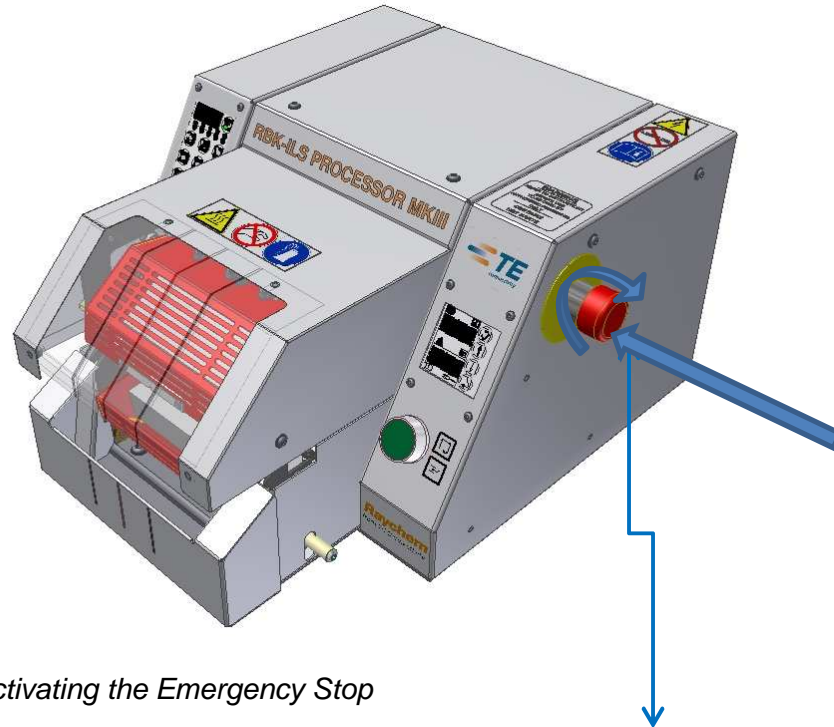



Fig. 3-2: Activating the Emergency Stop

1. To Power down the processor in an emergency, push the **EMERGENCY STOP** button (Fig 3.2.).
  - a) If the heater chamber is forward when **STOP** is activated it will move to the rear and eject the splice being processed. All power to the Processor is then turned OFF.
2. To restore the processor to its normal working condition release the **EMERGENCY STOP** button by rotating it clockwise.
  - a) The blue Stand-by LED will light.
3.  Reset the Processor by pressing the Start/Stop Switch on the Temperature Display Panel for three seconds until the green LED illuminates.

Once the heater chamber has returned to the selected temperature the Processor is then ready to continue operation.

### 3.2.13 Emergency Heater Chamber Release



**This is an EMERGENCY procedure used in the unlikely event of The Heater Chamber not opening when the Emergency stop is activated. The equipment is connected to an AC mains electricity supply. Before undertaking any maintenance or repair, always turn off the equipment and ensure it is isolated from the AC supply. Allow machine to cool down before starting this procedure!**

1. Push bottom heater guard to rear of machine until heater opens (Fig 3.3.).

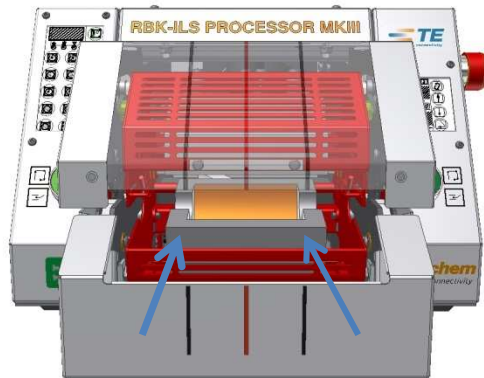

Fig. 3-3: Manual movement of bottom heater



**FRONT OF THE MACHINE CAN BE HOT TO THE TOUCH**



2. Push down on GRIPPER RELEASE studs and remove splice (Fig 3.4.).



Fig. 3-4: Manual splice release

### 3.2.14 Heater Carriage Jammed



Heater Carriage Jams. 'Cycle' LED is (Yellow) flashes  and the stand by indicator (blue)  flashes.

Power to the motor and to the heater removed.

- The RBK processor heaters will switch off automatically if the carriage has not reached the front sensor in 700ms. Power to the drive motor removed
- Heater's cool down and the RBK Processor will go into Stand-by mode, exactly as if the operator were preparing to switch the machine off. The Cycle LED will continue to blink, Indicating fault/Carriage jam.



- Allow machine to cool

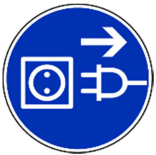

The equipment is connected to an AC mains electricity supply. Before undertaking any maintenance or repair, always turn off the equipment and ensure it is isolated from the AC supply

- Clear the jam. Check for signs of damage to Processor. Ref Emergency Heater Chamber Release: 3.2.13

To re-sett the Processor the operator must hold the Start/Stop switch (shown below) to bring the RBK out of stand-by.

Switch on the Processor by pressing the I/O Start/Stop Switch for three seconds.



- The green LED in the button will come on.
- The Processor will initiate.



- Check that the correct process button is selected for the task required.
- The active button has a green illuminated circle.

Press both start buttons once the heater return to its home position "ref 3.2.10 Operating cycle"  
This will move the mechanism back and reset the fault condition.

Processor is now ready to use.

### 3.2.15 Operator

#### Operator Indications and Alarms

Two types of indications and alarms are available to the operator:

- **General Information**
- **Fault Indications**
- **These indications are shown on the Process Time Display Panel and are accessed by repeatedly pressing the Selection button, as described in Table i below.**

Selection button	Press	Displayed Code	Interpretation
	<i>First</i>		<b>Selected Process Time</b> <i>Note:</i> <i>Temperature is displayed when outside of alarm bands.</i>
	<b>2</b>		<b>Selected Process Temperature</b> <i>(Display will revert after 10 Seconds)</i> <i>Note:</i> <i>Time is displayed when outside of alarm bands.</i>
	<b>3</b>	<i>cycH</i>	<b>Cycle counter high digit 10,000 to 99,990,000</b> <b>Processor operating cycle count.</b>
	<b>4</b>	<i>cycL</i>	<b>Cycle counter Low digit 0001 to 9,999</b> <b>Processor operating cycle count.</b>
	<b>5</b>	<i>hrsH</i>	<b>Operating hour's high digit count.</b>
	<b>6</b>	<i>hrsL</i>	<b>Operating hours low digit count.</b>
	<b>7</b>	<i>cycC</i>	<b>Operating cycles remaining to next calibration.</b> <b>Default starting parameter 010k.</b>
	<b>8</b>	<i>hrsC</i>	<b>Operating hours remaining until next calibration.</b> <b>Default starting parameter 350 hours. (Not Used)</b>
	<b>9</b>		<b>Scrolls back to first selection.</b>

- **Table i: Processor Operating Information**
- **The RBK- ILS Processor MK3 operating parameters are also viewed and entered from the Process Time Display Panel. Access is protected by a password not normally available to the operator.**
- **Setting these operating parameters is described fully in Section 4 - Service and Repair.**

### 3.2.16 Fault Indications

During the operation of the RBK- ILS Processor MK3 a fault may develop which initiates an alarm code. This code will be displayed as a 4 digit indication on the Temperature/Display panel.

Possible causes of a problem will fall generally into two categories:

- A fault with the heater chamber temperature.
- A fault with the mechanical movement.

A fault with the mechanical movement.

Fault / Code	LED indication	Possible Fault	Initial Action
To/c		Control thermocouple open circuit.	Turn off power to the Processor. Check the Heater and Fan Fuses replace if necessary. Re-start the unit. Check that the cooling fan is running. Starting the Processor will reset the fault condition.
Ts/c	Flashing RED	Control thermocouple short circuit.	
To/t		Control thermocouple over temperature 675°C.	

Table ii: Indicated Fault Codes

Note:

If the fault codes do not clear after carrying out the Initial Action in Table ii above, refer to the “Troubleshooting” on page 4-15.

Fault Condition	Indication	Initial Action
Mechanical Jam	 Flashing every 0.5 Sec.	REF.3.2.14 PAGE 3-10
Heater starts process but returns to the rear position immediately. - Indicating a Home/Load Sensor fault.		Press both start buttons to reset fault condition. If fault persists, replace or adjust sensor. Refer to the “Troubleshooting” on page 4-15.

Table iii: Heater Chamber Mechanical Failure

Indication	LED Indication	Reason	Initial Action
CAL! flashing	 Flashing AMBER	Calibration of the Processor is required.	This flashing LED indicates that the cycle count has exceeded the number of operations, or set hours of heater function. The indication can only be cleared by carrying out a calibration as described in “Calibration” on page 4-9.

Table iv: Calibrate Warning

### 3.2.17 Routine Maintenance

The RBK- ILS Processor MK3 requires only the minimum of maintenance. However, the following checks must be carried out on a weekly basis:

1. Check the cooling fan is operating correctly and air is flowing through the rear vent panel.



2. Remove front cover. Check for correct clearance (a minimum of 75mm clear space) and obstructions.

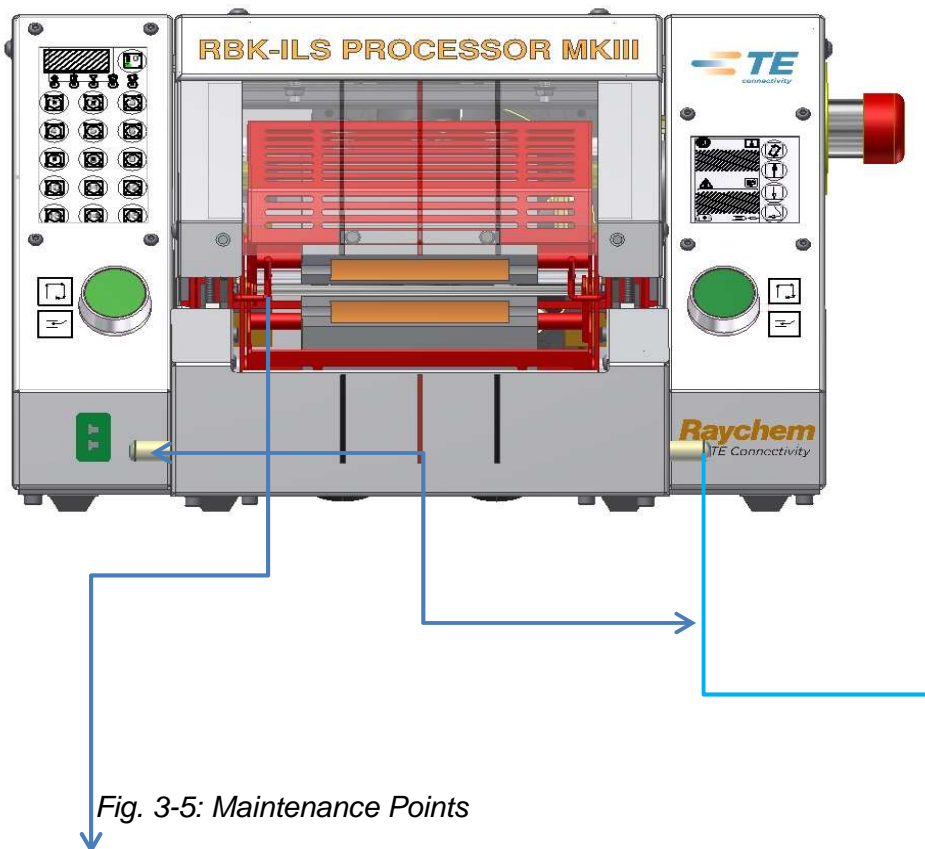

Fig. 3-5: Maintenance Points

3. Wire Grippers. Check visually for correct operation and signs of wear.
4. Manual Release. Check that manual release levers operate freely.

## 4. Service and Repair



**THE TASKS IN THIS SECTION SHOULD ONLY BE CARRIED OUT BY A SUITABLY QUALIFIED TECHNICIAN. THE MACHINE MUST BE ALLOWED TO COOL AND BE DISCONNECTED FROM THE MAINS SUPPLY BEFORE CARRYING OUT ANY REPAIR OR REPLACEMENT. THE MACHINE HAS A CAPACITOR AS PART OF THE AUTO-RETRACT FEATURE. NORMAL PRECAUTIONS REGARDING DISSIPATION OF STORED ENERGY MUST BE TAKEN PRIOR TO ANY SERVICE OR REPAIR. AFTER COMPLETION OF A REPAIR OR REPLACEMENT, THE APPROPRIATE SAFETY CHECKS MUST BE MADE. REFER TO THE “Electrical Safety Checks” section 2.2**

### 4.1 Processor Parameters

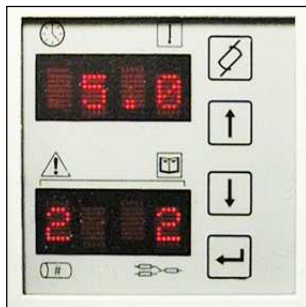





Fig. 4-1: Process Time Display Panel

#### 4.1.1 Selecting Processor Parameters

The processor parameters are entered from the right hand Process Time Display Panel shown above in Figure 4.1.

Two displays present the parameter information. The lower display indicates the parameter name and the upper indicates its value.

Access is by using the four selection keys described below:

Button	Description	Function
 + 	<b>Function &amp; Enter</b>	Both keys are used to enter parameter adjustment mode.
	<b>Function Select</b>	The select key selects the parameter digit for adjustment.
	<b>Increment Selection</b>	Steps up through the parameter menu. Increases the value of the digit to be changed.





	<b>Decrease Selection</b>	<b>Steps down through the parameter menu. Decreases the value of the digit to be changed.</b>
	<b>Enter Selection</b>	<b>Stores the adjusted parameter value. Holding for 3 seconds exits adjustment mode.</b>







Table v: Selection Button Function Continued

#### 4.1.2 Password Selection

A period of twenty five seconds elapses with no function key activated then the display will revert to the normal operating mode. Entry of an incorrect password will revert to the normal operating mode

Before access to the parameter mode is given, the selected password must be entered. The Processor has a default Password 0000. This should be changed if secure adjustment of the RBK- ILS Processor MK3 is required. Note:

Record any changed password. In the event of the password being lost the Processor parameters can be reset to the default settings, by applying power to the Processor with the Select and Enter buttons pressed. However this will result in the loss of previously entered parameters.

Action	Key	Upper and lower displays
1. Press the Function Select and Enter Keys simultaneously.	 + 	0 0 0 0 P W D ?
2. Press the Select key to select the first digit.		0 0 0 0 P W D ?
3. Set the first digit by selecting the Up or Down key for the first number of the password.	 	0 0 0 2 P W D ?
4. Press the Select key to step to the next digit.		0 0 0 2 P W D ?
5. Repeat the procedure to set each digit of the password.		3 7 9 2 P W D ?
6. Confirm the selected Password by pressing the Enter key. The first parameter is now displayed.		o f f R E M T
7. To change the password the parameters must be scrolled to the password select and the numbers re-entered as above (See Table vi).		0 0 0 0 P W D =
8. Adjustment of each parameter is carried out using the same key functions as for password selection.		

### 4.1.3 RBK- ILS Processor MK3 Parameters

The parameters listed in Table VI below can be adjusted and set in the Processor memory after the correct password has been entered.

	Default Value Parameters	Units	Range	Function
↓	<u>o f f</u> R E M T	-	(Off-On)	Remote on - enables remote operation through the RS232 Interface.
	<u>o f f</u> R P W I	-	(Off-On)	Remote power On on – enables the processor to be switched on from stand-by via the RS232 interface. On receipt of valid process parameters.
	<u>1 8 0</u> A P W O	min	Off or 1-240	Automatic Power Off 1 to 240 – sets the time in minutes from the last key press, before the Processor switches to stand-by (Always 60 mins for versions <1.7).
	<u>o f f</u> K E Y L	-	(Off-On)	Keypad Lock off – keypad normal (1 to 15 process select buttons available to the operator). On – keypad operation is restricted to the last active process select button before selecting 'KEYL on'.
	<u>o f f</u> S E Q U	-	Off 1-15	Sequence Mode 1 to 15 – sequence mode selected. See “Sequenced Mode” on page 4-5.
	<u>+ 0 0</u> O F S T	°C	-99 to +99	Temperature Control Offset Calibration value to be added to the Heater chamber temperature after the Processor temperature has been measured.
	<u>1 0</u> a l b L	°C	0-99	Temperature Alarm Band Low Sets the °C below the selected process temperature at which the Process is Inhibited (LED yellow).
	<u>1 0</u> a l b H	°C	0-99	Temperature Alarm Band High Sets the °C above the selected process temperature at which the Process is Inhibited (LED yellow).
	<u>0 1 4</u> P R O P	%of FS	000 to 199	Proportional Band Area around the selected process temperature where the output is at a level other than 100% or 0%. Increasing this parameter increases the width of this band.
	<u>0 4</u> I N T E	Sec.	00-99	Integral Corrects offset between selected process temperature and the proportional band over time. Increasing this parameter increases the time it takes to correct this offset.
↑	<u>0 1</u> D E R T	Sec.	00-99	Derivative Shifts the proportional band relative to the actual process temperature, damping the process temperatures tendency to over/under shoot when changing. Increasing this parameter will lengthen the time to change to another process temperature. These parameters have to be carefully adjusted together and are factory set.

Table vi: RBK- ILS Processor MK3 Parameters

	Default Value Parameters	Units	Range	Function
↓	$\frac{10.0}{CT1}$	Sec.	00.0 to 99.9	<b>Cycle Time</b> Sets the process time for selector button N° 1.
	$\frac{550t}{ST1}$	°C	00.0 to 600	<b>Cycle Temperature</b> Sets the process temperature for selector button N° 1.
	$\frac{-}{P\#1}$	-	1 to 3 A	<b>Product Size</b> Sets the product code (1; 2; 3; 3A) for process selector
<i>The next 14 parameters set the individual Time, Temperature and Product Size for the process selector buttons N° 2 to N° 15.</i>				
	$\frac{5}{BRN}$	-	1 to 7	<b>Brightness</b> Sets the level of the display brightness.
	$\frac{on}{Cint}$	-	(Off-On)	<b>Cycle Interrupt</b> On – during a product installation cycle operation of either Cycle Start button will abort the cycle and the heating chamber is moved to the rear position. The cycle is still recorded by the cycle counter. Off – the interrupt function is disabled.
	$\frac{075k}{calC}$	-	000 k to 150 k	<b>Cycle Count</b> The Cycle counter (cycC) counts down from the set level with every operation of the Processor. At the end of the count (000) the Calibration LED will be on, indicating calibration is required.
		-	0 to 999	<b>Operational Hours to Calibration</b> Not Used
			-99 to +999	<b>Calibration thermocouple scale factor</b> 107 for standard heating element.
	$\frac{0000}{calT}$		-99 to +999	<b>Calibration thermocouple scale factor</b> This parameter is factory set. Not present in software version 1.92 or later.
	$\frac{0000}{cntT}$	-	-99 to +999	<b>Calibration thermocouple scale factor</b> This parameter is factory set. Not present in software version 1.92 or later.
↑	$\frac{0000}{PWD=}$	-	0000 to 9999	<b>Enter/Change Password</b> Allows the entry of new password.

Table vii: RBK- ILS Processor MK3 Parameters

## 4.2 Defining Operating Modes

### 4.2.1 Local Operating Mode

The 15 process selection key parameters (time; temperature; product code) are assigned and stored in memory using the Parameter settings outlined previously in Table vi. Each process may be selected and used repeatedly.

SEQU	OFF
REMT	OFF
RPW1	OFF
KWYL	OFF ON

Table viii: Parameter Settings for Local Operation

### 4.2.2 Sequenced Mode

Process selection keys are enabled. After each process the current selection is advanced to the next, up to the selected number. The sequence is then restarted at N°1.

SEQU	1 to 15
REMT	OFF
RPW1	OFF
KWYL	OFF ON







Table ix: Parameter Settings for Sequenced Operation

### 4.2.3 Selecting and Operating the Sequenced M

Before selecting the number of process keys to be used (for example 5), each selected key must first have the time, temperature and product size parameters entered and stored in memory.

Note:

Setting SEQU selects the number of keys required starting with 1 and finishing with the required number e.g. 5.

Action	Key	Display
1. Hold the Function Select and Enter...	 + 	0 0 0 0 P W D ?
2. Enter Password and step through to Set Sequence mode.		o f f S E Q U
3. Use the Function Select key to step from 'off' to the N° of keys to be included in the Sequence e.g. 5.		5 S E Q U
4. Store this change into memory. The display will revert to normal. The first 5 process selection keys will be lit, with key N° 1 flashing. The Yellow Sequence LED is lit.		 + 

<p>5. <b>Initiate the first process cycle.</b> The heater chamber will move forward complete the cycle and then move to the rear. The Processor will then step to the next process key N° 2 which will flash. Key N° 1 will extinguish.</p>		
<p>6. <b>This procedure is repeated stepping through each process selection key in turn until the Processor scrolls back to key N°1.</b></p>		
<p>7. <b>Repeat the sequence as required.</b></p>		
<p>8. <b>To exit Sequence Mode</b> Reset SEQU to 'off'.</p>		$\begin{array}{r} \text{o f f} \\ \hline \text{S E Q U} \end{array}$

**Note:**

While in the SEQU mode the operator may start the sequence from any point by pressing the appropriate process selection key.

#### 4.2.4 Remote Operating Mode

The remote operating mode allows the RBK- ILS Processor MK3 to be controlled by external devices such as an industrial Computer or Ultrasonic Welding equipment.

Remote operation is enabled via the RS232 communication interface, through an RS232 cable connected to the external device.

S E Q U	OFF)
R E M T	ON
R P W 1	OFF / ON
K W Y L	OFF

Table x: Parameter Settings for Remote Operation

The initial process values will default to those set when the Processor was last used remotely. Remote overrides local operation, all 15 process buttons and the UP and DOWN selection keys will be disabled.

On receipt of new process values, two sequencing arrows 10 .0 pointing to the product size replace the sequence button number.

$$\begin{array}{r} 10 . 0 \\ \hline 3 A \leftarrow \end{array}$$

On completion of the cycle the arrows extinguish until further process values are received.

The current REMT parameters will remain in memory during power down of the Processor.

If the Processor Remote parameters are then set to 'off', the local values used prior to the Remote selection are restored. The Processor will remain in the Remote condition permanently or until manually reset to 'off'.

#### 4.2.5 RS232 Data Format

All data is transmitted in ASCII form. The Data format uses 8 data bits, 1 stop bit, no parity at 9600 baud. Full duplex TX/RX exists, RTS/CTS is disabled. The RBK- ILS Processor MK3 Processor recognises the following fourteen byte information packet structure.

<b>BYTE 1</b>	<b>Start of Header (SOH) (always ASCII 01h)</b>
<b>BYTE 2</b>	<b>10's of seconds (ASCII 30h to 39h (1 to 9))</b>
<b>BYTE 3</b>	<b>1's of seconds (ASCII 30h to 39h (1 to 9))</b>
<b>BYTE 4</b>	<b>Always a decimal point (ASCII 2Eh)</b>
<b>BYTE 5</b>	<b>0.1's of seconds (ASCII 30h to 39h (1 to 9))</b>
<b>BYTE 6</b>	<b>Always a NULL (always ASCII 00h)</b>
<b>BYTE 7</b>	<b>Product size code (ASCII numeric – (1 to 3) – see below)</b>
<b>BYTE 8</b>	<b>Product size code (ASCII numeric – ('_' or A)– see below)</b>
<b>BYTE 9</b>	<b>100's of deg. C</b>
<b>BYTE 10</b>	<b>10's of deg. C</b>
<b>BYTE 11</b>	<b>1's of deg. C</b>
<b>BYTE 12</b>	<b>Checksum high hex nibble (ASCII value 0–9 A–F) F)</b>
<b>BYTE 13</b>	<b>Checksum low hex nibble (ASCII value 0–9 A–F)</b>
<b>BYTE 14</b>	<b>End of transmission (EOT) (always ASCII 04h)</b>

The checksum hex (A-F) must be in ASCII lower case.

The RBK- ILS Processor MK3 Processor will ignore all RS232 data until a SOH character is recognised. On receipt of a SOH, 10 additional characters or an EOT character is sought. For each character received (including the SOH) the longitudinal addition (checksum) is maintained up to and including byte 11. Overflow of the checksum beyond a byte boundary is discarded; This single byte checksum is converted to two ASCII characters and compared with bytes 12 and 13 of the received packet.

The RBK- ILS Processor MK3 responds 100ms after receipt of the above data packet with either a single ACK (acknowledgement) (ASCII 06h) or a NAK (not acknowledgement) (ASCII 15h) character. An ACK response will occur providing the following verifications are met:

- a) The checksum Byte compares.
- b) The packet format meets the above defined format. (i.e., The decimal point and null characters occur in the correct positions and the expected numeric values represented by ASCII 30–39 are present).

Failure to meet these requirements results in the RBK- ILS Processor MK3 responding with a NAK.







The only exception unchecked is product size value.

The two ASCII values designated product size are unchecked as part of the receive protocol other than being included in the checksum calculation (i.e. any data received in these positions will not result in NAK response). However, the software will only display product sizes for the following received ASCII characters in these positions: 1\_/2\_/3\_/3A (where \_ is a ASCII null (00h)). Any other data received results in a blank product size display.

#### 4.2.6 Keypad Lock Mode

The keypad lock selector parameter KEYL restricts operator process selection in local static and sequential operating modes.

The keypad lock mode is set as follows:

Action	Key	Display
1. <b>1. Select the process selection key to be locked. Check Time, Temperature and product code are correct...</b>		1 0 . 0 ----- 3 A ←
2. <b>Hold Function Select and Enter Keys for 3 Seconds to enter Parameter Mode.</b>	 + 	0 0 0 0 ----- P W D ?
3. <b>Enter Password and step through to Keypad Lock Mode.</b>		o f f ----- K E Y L
4. <b>Use Function Select key to select KEYL 'on'.</b>		o n ----- K E Y L
5. <b>Store change into memory. Display will revert to normal. The process selection key selected prior to setting KEYL will be the only one active.</b>	 	1 0 . 0 ----- 3 A ←
6. <b>Selected process cycle may now be carried out as normal.</b>		
7. <b>To exit Keypad Lock Mode, enter of the parameters as before and Reset KEYL to 'off'...</b>		o f f ----- S E Q U

## 4.3 Calibration

Calibration of the RBK- ILS Processor MK3 is carried out by using a UHI probe (CLT-EQUIP-UHI-250A-1-PRB 288869-000-PROBE and CLTEQ-UHI250EXT-CABL 952687-000-CABLE), plugged into the 'K' type thermocouple socket. (See: Figure 4.2.)

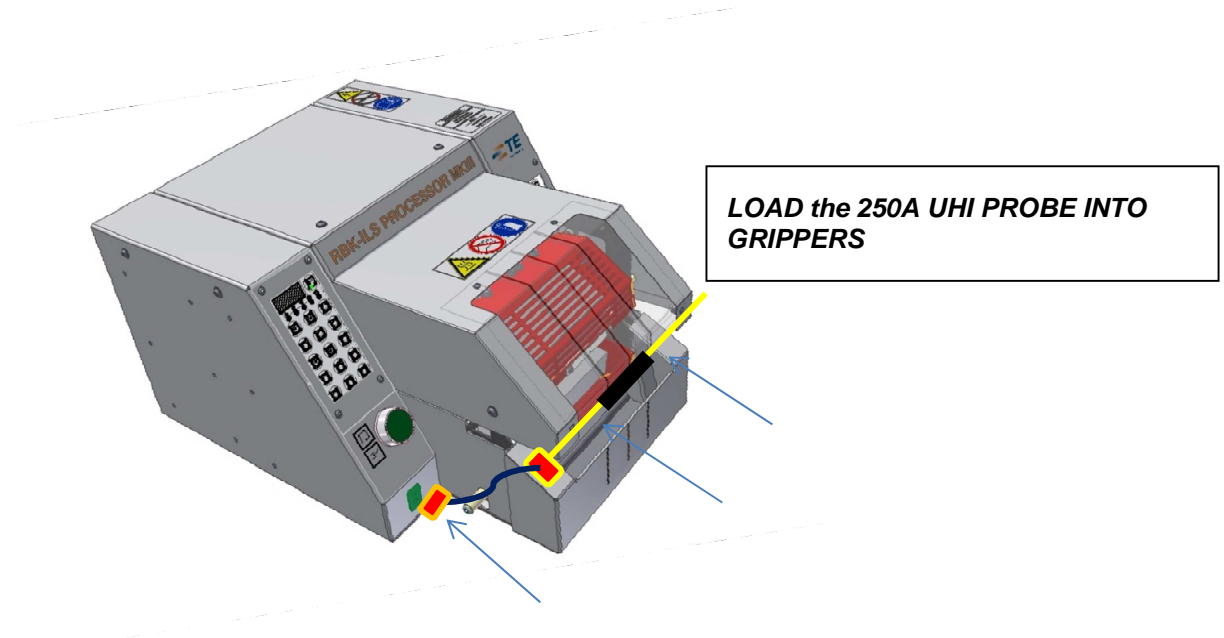

Fig. 4-2: Processor Calibration

Calibration of the Processor can be performed at any time, however when the calibrate LED is flashing accompanied by 'CAL!' indicated in the Temperature Display Panel, a calibration is required. To extinguish the flashing indications, a calibration of the Processor must be carried out.

The calibrate LED will flash either when:

- a) The Cycle count 'calC' set in the Parameters has counted down.
- b) Or the number of hours that the Processor has been powered with the Heater on has been exceeded. This parameter is factory set to 350 hrs.

Note:

Interrogation of the operating cycles remaining 'cycC' and hours remaining 'hrsC' can be read from the Process Time Display Panel. (See Table i) on page 3-10. Section 3.2.15

- c) The 'calC' LED will be on, when the calibration mode is selected.

### 4.3.1 Automatic Calibration Procedure

The following procedure describes how to calibrate the Processor, by comparing the expected UHI probe peak temperature with the actual UHI peak temperature recorded after a 15 second cycle. The MK3 RBK-ILS processor will automatically calculate the temperature Offset required to correct any errors and automatically replace the existing Offset value in the parameter memory.



A negative Offset increases the heater actual temperature and a positive Offset will decrease it. The automatic calibration procedure requires the processor to stabilise for 15 minutes after auto calibration. Repeating this procedure within this time may cause a large offset value to be obtained - do not repeat within 15 mins.



## Automatic Calibration Procedure

**Note:**

If the UHI probe is temporarily removed, or removed “too” soon, CAL! will continue to flash.

Action	Display
<p>1. Ensure that the Processor has been at 500°C for 30 minutes prior to performing a calibration. If the set temperature was set higher or lower, allow a further 15 minutes after the probe has been inserted into the front socket. This allows the heating chamber to stabilise.</p>	
<p>2. Connect the UHI probe to the front panel socket.</p> <p>a) This will automatically select calibrate mode (calibrate LED on).</p> <p>b) Calibrate mode may be selected or de-selected using the select key. Connection of UHI probe alters select key operation.</p> <p>c) Upper timer display indicates pre-set calibration time (15 seconds) and the lower shows UHI temperature.</p> <p>d) Temperature display will flash if set temperature is outside the range 500°C to 550°C. (Automatically set to 500°C if outside of this range 15.0 for the duration of the calibration Procedure).</p>	  $\begin{array}{r} 15.0 \\ \hline 18C \end{array}$ $\begin{array}{r} 15.0 \\ \hline / 18C \end{array}$
<p>3. Place the UHI probe centrally into the Processor jaws.</p> <p>a) The UHI probe temperature must be cooled to 23°C, outside this, temperature will Flash until it 48C has reached 23°C. (No calibration is permitted)</p> <p>b) A rotating bar to the left of the UHI temperature indicates that a calibration cycle can be performed.</p>	$\begin{array}{r} 15.0 \\ \hline 48C \end{array}$ $\begin{array}{r} 15.0 \\ \hline / 18C \end{array}$
<p>4. Initiate a process cycle.</p> <p>a) Timer display counts down from the (15s).UHI temperature will rise.</p> <p>b) If after 5 seconds the Processor does not detect a 108C UHI increase of 5°C the cycle will be aborted. i.e. If probe is not inside heater during cycle.</p>	$\begin{array}{r} 04.3 \\ \hline 108C \end{array}$
<p>5. Once the cycle is completed the UHI will be ejected. DO NOT UNPLUG THE UHI PROBE AT THIS STAGE Allow 15 seconds after UHI is ejected for machine to calculate and adjust OFST before removing UHI from socket.</p>	



**CAUTION HIGH TEMPERATURES**

Take care when handling the ejected UHI probe after a calibration cycle. It will be HOT.

<p>a) UHI peak temperature is shown in the upper display. 111 C (The reducing probe temperature will be displayed in the lower display.)</p>	$\begin{array}{r} 111\text{ C} \\ \hline 106\text{ C} \end{array}$
<p>b) Processor calculates offset value. (timer displays are blank).</p>	
<p>c) Offset value ('OFST') is shown briefly in the top -1 2C display and entered into memory, replacing the existing value. This value will be in the range -99°C to +99°C.</p>	$\begin{array}{r} -12\text{ C} \\ \hline \end{array}$



If actual UHI temperature is less than or greater than the expected UHI temperature by more than 5°C, then calibration mode will not clear (Cal! is displayed). Another calibration is required as the offset value has changed - wait 10 minutes to allow the UHI probe temperature to fall and then repeat the Calibration procedure from Step 3.

**Note:**

If the UHI probe is temporarily removed, or removed too soon, CAL! Will continue to flash.



If the result of the calculation is within the -99°C to +99°C limit, the existing OFST is replaced. (The new value is displayed in the upper display for about one second, then the calibrate mode automatically de-selects.)

$$\begin{array}{r} -12\text{ C} \\ \hline \end{array}$$

<p>6. Unplug the UHI probe (Cal! no longer displayed).</p>	
<p>7. Normal machine operation can now be resumed.</p>	



If the result of the offset calculation is outside the -99°C to +99°C limit, the Offset value is discarded and calibration out of range (Co/r) will be displayed.

$$\begin{array}{r} \text{Co/r} \\ \hline \end{array}$$

If Co/r is still shown, de-select the calibration mode by pressing the select key, or unplug the UHI probe from the Processor. It is recommended to replace the heater set if the offset value is greater than ± 99°C. Auto calibration is then required. (Offset value has not been replaced).



#### **4.3.2 Manual Calibration Procedure**

- 1. Set tool to 500°C and 15 second cycle time.**
- 2. Set CalF to 107°C**
- 3. Connect UHI probe to a calibrated meter.**
- 4. Carry out 3 calibration readings (cool UHI to 23°C between each cycle). Calculate average value.**
- 5. Compare measured value (average) with desired value of 130°C ± 5°C. If below, adjust OFST to desired value - measured value (negative result). If above, adjust OFST to measured value - desired value (positive result).**
- 6. Wait 25 minutes for temperature to stabilise.**
- 7. Repeat 3 (and 4 if necessary).**
- 8. After OFST has been adjusted correctly it is necessary to wait 15 minutes for temperature to stabilise prior to normal use.**

**It is recommended to carry out an auto calibration after manual calibration in order to remove the Cal!**

**Message in the display panel.**

**Note: If this does not disappear it is necessary to replace the heater set and auto calibrate.**

## 4.4 Gaining Access



**THE TASKS IN THIS SECTION SHOULD ONLY BE CARRIED OUT BY A SUITABLY QUALIFIED TECHNICIAN. THE MACHINE MUST BE ALLOWED TO COOL AND BE DISCONNECTED FROM THE MAINS SUPPLY BEFORE CARRYING OUT ANY REPAIR OR REPLACEMENT.**

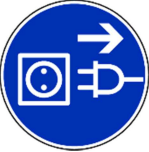

**THE MACHINE HAS A CAPACITOR AS PART OF THE AUTO-RETRACT FEATURE. NORMAL PRECAUTIONS REGARDING DISSIPATION OF STORED ENERGY MUST BE TAKEN PRIOR TO ANY SERVICE OR REPAIR.**

**AFTER COMPLETION OF A REPAIR OR REPLACEMENT, THE APPROPRIATE SAFETY CHECKS MUST BE MADE. REFER TO THE "Electrical Safety Checks" on page 4-36.**

To gain access to the internal components, the side and top panels must be removed. Use the correct size Key. (Figure. 4.3 & 4.4. below).

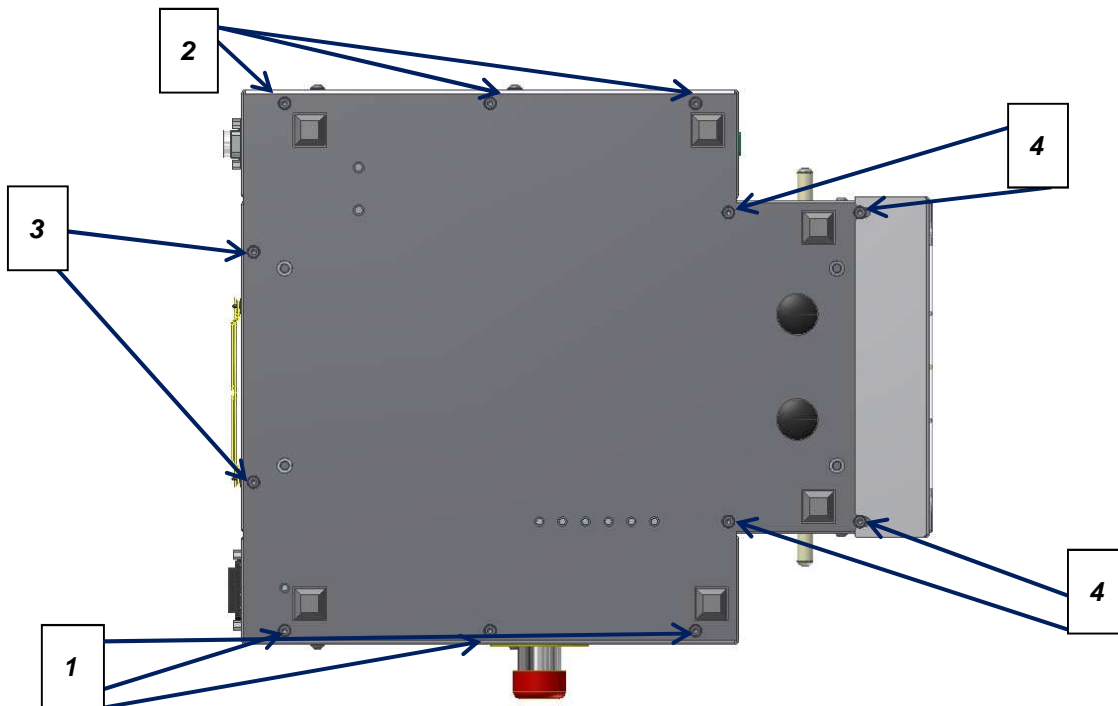
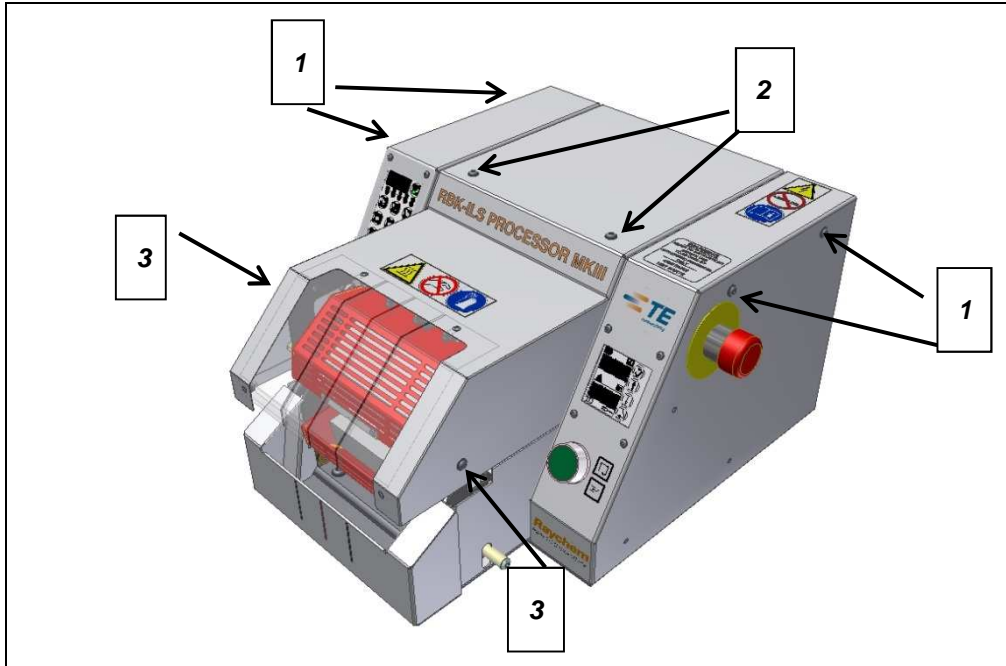

Fig. 4-3: Base Securing Screws

- 1 = Left Side Panel Lower Securing Screws**
- 2 = Right Side Panel Lower Securing Screws**
- 3 = Rear/Top Panel Lower Securing Screws**
- 4 = Heater Side Panel Lower Securing Screw**

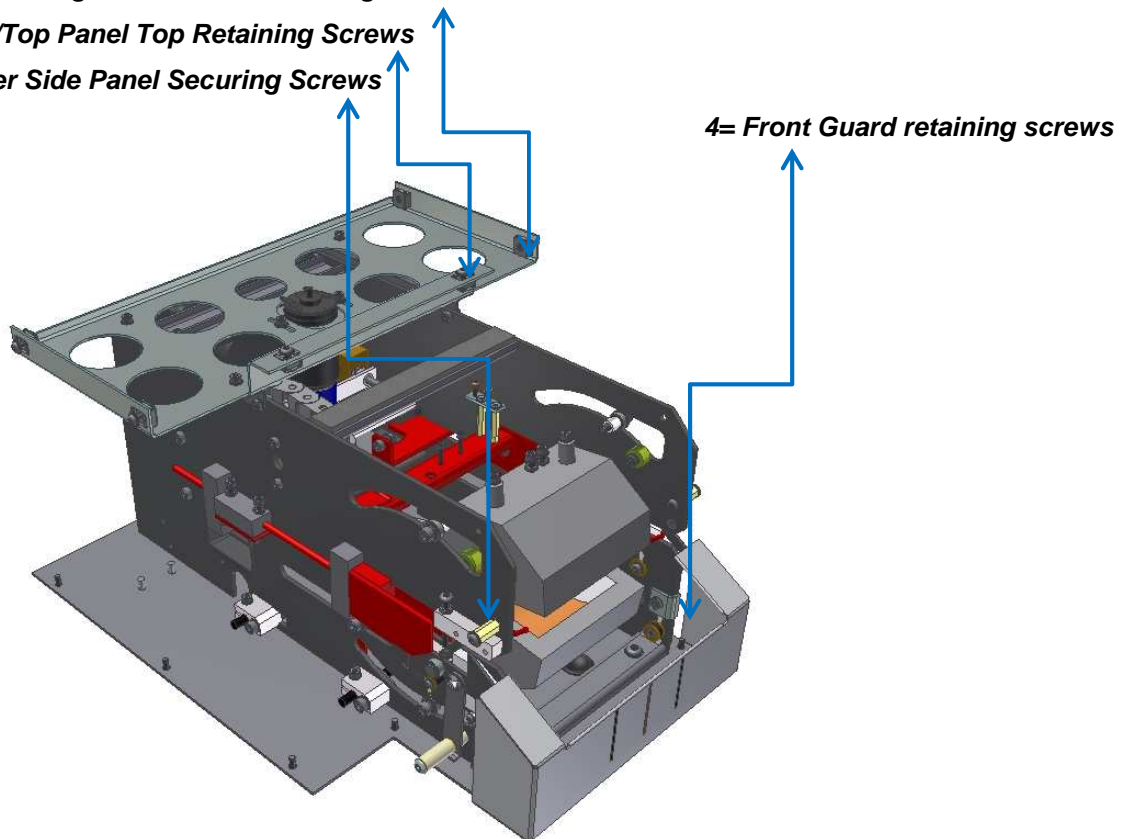

*Fig. 4-4: Side and Top Securing Screws*

**1 = Left and Right Side Panel Securing Screws**

**2 = Rear/Top Panel Top Retaining Screws**

**3 = Heater Side Panel Securing Screws**



**4 = Front Guard retaining screws**

## 4.5 Troubleshooting



**THE TASKS IN THIS SECTION SHOULD ONLY BE CARRIED OUT BY A SUITABLY QUALIFIED TECHNICIAN. BEFORE STARTING ANY REPAIRS, THE MACHINE MUST BE DISCONNECTED FROM THE MAINS SUPPLY. AFTER COMPLETION, THE APPROPRIATE SAFETY CHECKS MUST BE MADE.**

**If a fault develops, the following tables will help in identifying the fault. Refer to the section on “Repair” on page 4-22 for details on how to replace parts.**

### 4.5.1 Fault Analysis

**There are two types of fault condition:**

- a) Heater chamber**
- b) Mechanical movement.**



**Heater Chamber Faults:**

**Are detected by the control thermocouple, which is part of the lower heater.**

**Unexpected thermocouple readings will result in the heater LED flashing ‘Red’. One of three warning messages will then be shown on the temperature display.**

- i. 'To/c' - Control thermocouple open circuit.**
- ii. 'Ts/c' - Control thermocouple short circuit.**
- iii. 'To/t' - Control thermocouple over temperature.**

**Each of these faults causes the heater to be switched off.**

**Mechanical Movement Faults:**

**These are detected by the state of the ‘Home’ and ‘Load’ proximity sensors, located in the base of the Processor. (Figure 4.12.)**



**Deviation from the expected sensor state results in the ‘Cycle’ LED flashing and removal of power to the motor and to the heater. Movement faults will either be detected immediately or when a cycle is initiated.**

**A 700mS time out condition also exists, i.e. any jamming of the movement will result in a movement fault. The fault condition is ‘latched’. Refer to 3.2.14 page 3-10 “Heater carriage jammed”**



#### 4.5.2 Preliminary Checks

Before investigating a fault condition check:

1. MAINS ISOLATION switch is in ON position.
2. EMERGENCY STOP switch is in OUT position.
3. All fuses are OK.
4. Power supply is ON.

#### 4.5.3 Abbreviations

The following abbreviations are used:



PCB	Printed Circuit Board
TI	Thermocouple Interface
GC	Generic Controller
PTDP	Process Time Display Panel
TDP	Temperature Display Panel
PS	Power Switching
PSU	Power Supply Unit
SSR	Solid State Relay

**Note:**



For PCB circuit refer to diagrams in Section 6.

#### 4.5.4 Troubleshooting Table

Problem	Possible Cause	Verification	Solution
<b>All LED's OFF</b>	<b>No power.</b>	<b>Unplug mains power cable. Check mains supply present.</b>	<b>Restore power supply.</b>
	<b>Mains Switch not in the 'ON' position and/or the Emergency Stop switch pressed...</b>	<b>Blue stand-by LED is illuminated when the Mains switch and the emergency stop are in the correct position.</b>	<b>Set switches to correct position.</b>
	<b>Mains input fuses failed</b>	<b>Remove and check.</b>	<b>Replace if necessary. Refer to section 4.6.1 for correct Item. Page 4.22</b>
	<b>24V DC PSU Fault</b>	<b>Check 24-32V is present on J2 on PS PCB.</b>	<b>Replace 24V DC PSU.</b>
	<b>Internal Polyswitch R3 tripped or defective</b>	<b>With input power connected to the unit check for 24V DC at socket J1 on the PS PCB.</b>	<b>If 24V is present, switch off power to the Processor and allow 2 mins for the polyswitch to reset. Restart the unit if the fault is still apparent, replace the PS PCB.</b>

Problem	Possible Cause	Verification	Solution
<b>All LED's OFF</b>	<b>Check 24V dc present on TI PCB.</b>	<b>Check 24-32V is present at J9 on TI PCB.</b>	<b>Rectify connection between PS PCB and TI PCB.</b>
	<b>Disconnected Connector J2 on GC PCB.</b>	<b>Check disconnected lead between GC PCB and J2 on both front display panels.</b>	<b>Correct connection...</b>
	<b>Generic Controller fault.</b>	<b>At least 1 red LED should be flashing on the GC PCB.</b>	<b>Check EPROM installed. Replace GC PCB.</b>
<b>Blue stand-by LED is permanently ON.</b>	<b>I/O switch not pressed.</b>	<b>Press I/O switch for 3 seconds until display illuminates.</b>	<b>Replace TDP.</b>
	<b>I Faulty I/O Switch...</b>		
	<b>Faulty Isolation Relay (RL4) on the PS PCB.</b>	<b>Start the Processor and check the relay contacts operate. (relay operation can be heard with the covers on)</b>	<b>Replace if necessary. (Section 4.5.19) Page 4.38</b>
<b>'To/c' indicated. Heater LED RED flashing.</b> 	<b>Control thermocouple open circuit</b>	<b>Check thermocouple resistance at connector J3 pins 1 &amp; 2. (should be approximately 2 ohms.) If resistance is infinite, thermocouple is defective.</b>	<b>Check compensating cable between J3 and SK5. Replace cable as required. Check thermocouple resistance at PL5. Replace lower heater as required. Section 4.6.4/4.6.5 Page 4.23</b>
<b>'Ts/c' indicated. Heater LED RED flashing.</b> 	<b>Blown Heater Fuse.</b>	<b>Remove and check.</b>	<b>Replace if necessary. Section 4.6 For correct Item. Page 4.22</b>
	<b>Defective thermocouple compensating cable.</b>	<b>Check for short circuit compensating cable.</b>	<b>Replace compensating cable. Section 4.5.17</b>
	<b>Control thermocouple short circuit.</b>	<b>Unplug control thermocouple at PL5, check for short circuit between J3 pins 1 &amp; 2. Check for short circuit on PL5 pins 1&amp;2.</b>	<b>Check that the 'a1bL' &amp; 'a1bH' Parameters have been set correctly. Check that the thermocouple resistance is approximately 2 ohms. Replace compensating cable if required. Replace lower heater if required</b>
	<b>Open circuit control signal between J10 and SSR.</b>	<b>Red LED on TB PCB always off. Check for continuity between J10 pins 1&amp;2 on the TI PCB.</b>	<b>Repair any fault as required.</b>



Problem	Possible Cause	Verification	Solution
<p><b>'Ts/c' indicated. Heater LED RED flashing.</b></p> 	<p><b>Heater element open circuit</b></p>	<p><b>Check resistance of heater element assembly at the terminal block mounted at the rear of the heat chamber. Resistance should be &gt;100 ohms, &lt; 200 ohms across terminals (2) and (8) (Fig 4.8.). If not heater element assembly is defective.</b></p>	<p><b>Replace heater element assembly. Section 4.6.4/4.6.5/4.6.6 Page 4.23</b></p>
	<p><b>Defective wiring between solid state relay and heater, or break in neutral line to heater.</b></p>	<p><b>Check continuity between connector J4 socket pin 5(L) and pin 11(N) on power switching PCB...</b></p>	<p><b>Replace Defective Wiring...</b></p>
	<p><b>Isolation relay RL4 defective.</b></p>	<p><b>Start Processor and check relay contacts operate. (relay operation can be heard with the covers on)</b></p>	<p><b>Replace if necessary. (page 4.37)</b></p>
	<p><b>Solid State Relay RL3 defective.</b></p>	<p><b>Start the Processor, check that RL4 operates, check AC power at J4 on power switching PCB.</b></p>	<p><b>If no AC Power is measured replace the power switching PCB. (page 4-37)</b></p>
<p><b>'To/t' Displayed. Heater LED RED flashing</b></p> 	<p><b>Thermocouple over temperature.</b></p>	<p><b>The control thermocouple has detected a temperature of 675°C in the heater chamber.</b></p>	<p><b>RL3 permanently on. Replace PS PCB. (page 4-37)</b></p>
<p><b>Co/r displayed following calibration. (OFST &gt; ± 99)</b></p>	<p><b>Incorrect calibration procedure carried out</b></p>	<p><b>Carry out factory reset. Calibrate according to correct procedure - particularly wait time.</b></p>	<p><b>Replace heater set if correct calibration does not reset Co/r (or Call!) message.</b></p>
	<p><b>Incorrect thermocouple contact on element</b></p>		
<p><b>Processor will not cycle.</b></p>	<p><b>Actual temperature outside set temperature band.</b></p>	<p><b>Check that the Heater LED is Green, indicating actual temperature is within the alarm band. Check that the 'a1bL' &amp; 'a1bH' Parameters have been set correctly.</b></p>	<p><b>Adjust parameters. (page 4-1)</b></p>
	<p><b>One cycle start button disconnected.</b></p> <p><b>Safety Relay PCB</b></p>	<p><b>When pressing start buttons check connections to S4 and S3 to the SAFTEY RELAY and interface board. Check power LED is "ON" SAFTEY RELAY</b></p> <p><b>Check RL1 -continuity. between J1Pins 5 and 6</b></p> <p><b>Check RL2 continuity. between J3 Pins 1 and 2</b></p>	<p><b>Replace button as required. Correct wiring fault as necessary</b></p> <p><b>Wiring error "replace."</b></p> <p><b>Replace defective Safety PCB.</b></p>

Problem	Possible Cause	Verification	Solution
<p><b>Heater chamber fails to move when start buttons pressed. Cycle LED flashes.</b></p> 	<b>Heater not in rear position.</b>	<b>Check heater chamber position. Check for obstruction.</b>	<b>Remove obstruction. Press cycle start buttons to return heater to the rear position.</b>
	<b>'Home' sensor failed or stuck OFF.</b>	<b>Check sensor gap and position. Sensor should be illuminated. Check LED D27 on GC PCB illuminates. Check wiring and connections.</b>	<b>Adjust sensor position or replace if required. (page 4-26) Rectify wiring fault.</b>
	<b>'Load' sensor failed or stuck ON.</b>	<b>Check heating chamber is in the 'Home' position. Sensor should be illuminated. Check sensor gap and position. Check LED D28 on GC PCB illuminates.</b>	<b>Check wiring and connections. Adjust sensor position or replace if required. (page 4-26)</b>
	<b>Relay RL1 not operating when the start buttons are pushed</b>	<b>Check that when the start buttons are pressed there is a logic low (0V) present at J1 pin 4 on the Power Switching PCB.</b>	<b>Replace the isolation relay RL1. (page 4-38)</b>
		<b>Check that when the start button is pressed there is a logic low (0V) present at J9 pin 5 on the Thermocouple Interface PCB.</b>	<b>Replace the Thermocouple Interface and or the Control PCB. (page 4-36)</b>
	<b>Internal Poly switch R1 tripped or defective.</b>	<b>When the start buttons are pressed check RL1 operation and for 24V DC at socket J3 on the Power Switching PCB.</b>	<b>If 24V is present switch off power to the Processor and allow 2 mins for the polyswitch to reset. Restart the unit - if the fault is still apparent replace the Power Switching PCB.</b>
	<b>Motor Failure</b>	<b>Check power to motor (24V dc) when start buttons are operated.</b>	<b>Replace motor. (page 4-29) Rectify wiring fault.</b>
	<b>Mechanical Jam.</b>	<b>See section 3.214 page 3-10</b>	

Problem	Possible Cause	Verification	Solution
<p><b>Heating chamber moves forward and returns immediately to the Home position. Cycle LED flashes</b></p> 	<p><b>'Load' proximity sensor permanently 'OFF' or defective. May be positioned incorrectly.</b></p>	<p><b>Check that the 'Load' sensor internal LED D28 is illuminated on the GC PCB.</b></p>	<p><b>Adjusting sensor position. (page 4-26)</b> <b>Replace sensor if necessary. (page 4-27)</b></p>
		<p><b>Check that the LED D28 on the Control PCB is lit with the chamber in the loaded position. Move heater to loaded position to check the LED.</b></p>	<p><b>Replace Control PCB. (page 4-34)</b></p>
		<p><b>Pressing the cycle buttons will reset the sensor control but will move the chamber to the Home position if not correct.</b></p>	
<p><b>Machine overheats. Covers and guards are warmer than normal.</b></p>	<p><b>Switch off procedure not being observed.</b></p>	<p><b>Switch off at I/O switch</b> <b>Fan will continue to run until 190°C and then switch off.</b> <b>Blue stand-by led will be lit.</b></p>	<p><b>Ensure correct switching procedures are carried out. (page 3-4 &amp; page 3-7)</b></p>
	<p><b>Cooling fan failure</b></p>	<p><b>Check fan function.</b></p>	<p><b>Replace fan. (page 4-32)</b></p>
	<p><b>No 24V DC power to Generic Controller PCB.</b></p>	<p><b>Carry out no power condition checks.</b></p>	<p><b>Identify fault and correct to restore power.</b></p>
<p><b>Process Time Display Panel will not operate, malfunctions, will not power up.</b></p>	<p><b>Open circuit connection between PTDP and TDP.</b></p>	<p><b>Check connections between TDP and GC PCB.</b> <b>Substitute PTDP.</b></p>	<p><b>If fault clears Replace PTDP (page 4-40)</b></p>
	<p><b>Defective TDP.</b></p>	<p><b>Substitute new TDP.</b></p>	<p><b>If fault clears Replace TDP. (page 4-39)</b></p>
	<p><b>Defective GC PCB</b></p>	<p><b>Substitute new GC PCB.</b></p>	<p><b>If fault clears Replace GC PCB. (page 4-34)</b></p>
<p><b>Temperature Display Panel will not operate but temperature display is illuminated.</b></p>	<p><b>Keypad Lock Mode 'KEYL' selected on.</b></p>	<p><b>Check in parameter for KEYL settings.</b></p>	<p><b>Reset KEYL to off</b></p>

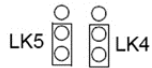
Problem	Possible Cause	Verification	Solution
<b>Temperature Display Panel not illuminated.</b>	<b>Open circuit connection between TDP and GC PCB.</b>	<b>Check connections between TDP and GC PCB.</b>	<b>Substitute New TDP. If fault clears Replace TDP Refer to page 4-39</b>
	<b>Defective GC PCB.</b>	<b>Substitute new GC PCB.</b>	<b>If fault clears replace GC PCB. (page 4-34)</b>
<b>RS232 Communication does not function.</b>	<b>'REMT' not on.</b>	<b>Check parameters.</b>	<b>Set 'REMT' to on.</b>
	<b>RS232 cable not connected to welder or Processor.</b>	<b>Check interconnecting cable.</b>	<b>Reconnect...</b>
	<b>Internal interconnection not made. RS232 driver not installed.</b>	<b>Check wire between rear interface socket PL2 and J7 on the GC PCB. Check for correct link settings on LK2, 3, 4, &amp; 5. on the GC PCB.</b>	<b>Connect wiring. Check links are set:</b> LK3 ○□□□ LK2 ○○ 

## 4.6 Repair



**THE TASKS IN THIS SECTION SHOULD ONLY BE CARRIED OUT BY A SUITABLY QUALIFIED TECHNICIAN. THE MACHINE MUST BE ALLOWED TO COOL AND BE DISCONNECTED FROM THE MAINS SUPPLY BEFORE CARRYING OUT ANY REPAIR OR REPLACEMENT.**



**THE MACHINE HAS A CAPACITOR AS PART OF THE AUTO-RETRACT FEATURE. NORMAL PRECAUTIONS REGARDING DISSIPATION OF STORED ENERGY MUST BE TAKEN PRIOR TO ANY SERVICE OR REPAIR.**

**AFTER COMPLETION OF A REPAIR OR REPLACEMENT, THE APPROPRIATE SAFETY CHECKS MUST BE MADE. REFER TO THE “Electrical Safety Checks” on page 4-41.**

### 4.6.1 Circuit Protection Devices



Fig. 4-5: Circuit Protection devices

- 1 = FAN Fuse (240V, 200mA anti-surge)
- 2 = HEATER Fuse (240V d.c. 2A anti-surge)
- 3 = Mains Fuses (2 x 240V, 3.15A anti-surge)

### 4.6.2 External

**The Processor is protected by four external fuses fitted at the back of the unit, as shown in Figure 4.5.**

### 4.6.3 Internal

**Two protective ‘Polyswitch’ devices are mounted on the PS PCB.**

- a) ‘R3’ provides protection for the 24V DC supply to the PCB.
- b) ‘R1’ is connected in the switched (RL1) supply to the motor.

**Both switches will automatically reset once activated by removing the AC power from the Processor.**

#### 4.6.4 Heater Element Replacement.



**ENSURE THAT MAINS SUPPLY IS DISCONNECTED.**

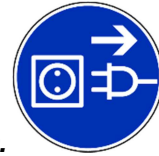

**The two heater elements are mounted within a protective cage. Each are removed separately, but must be replaced as a set. REMOVE FRONT SAFTEY COVER**

#### 4.6.5 Upper Element

1. **Loosen top and side covers (See “Compare measured value (average) with desired value of  $130^{\circ}\text{C} \pm 5^{\circ}\text{C}$ . If below, adjust OFST to desired value - measured value (negative result). If above, adjust OFST to measured value - desired value (positive result).” on page 4-11) and remove top cover and front cover.**

2. **Remove heater chamber cover.**

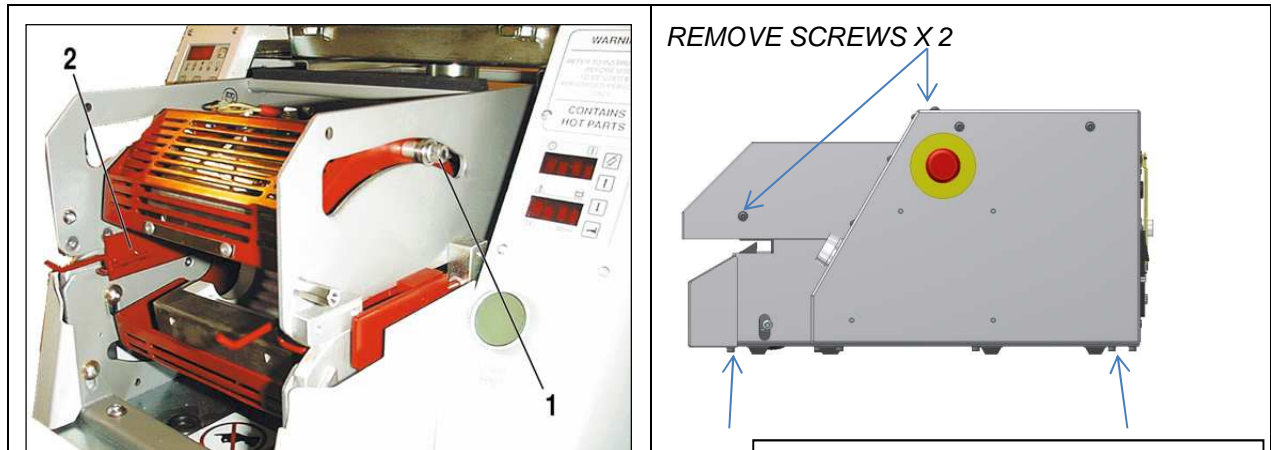

Fig. 4-6: Heater Chamber in 1st Position

1 = Bearing Assembly  
2 = Heater Blade

Remove screws ref fig 4.3 page 4-15

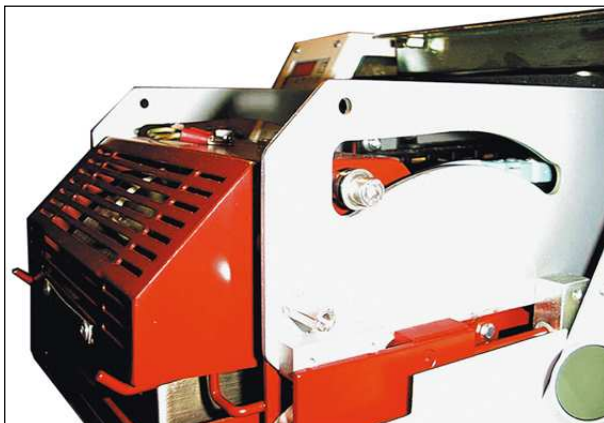
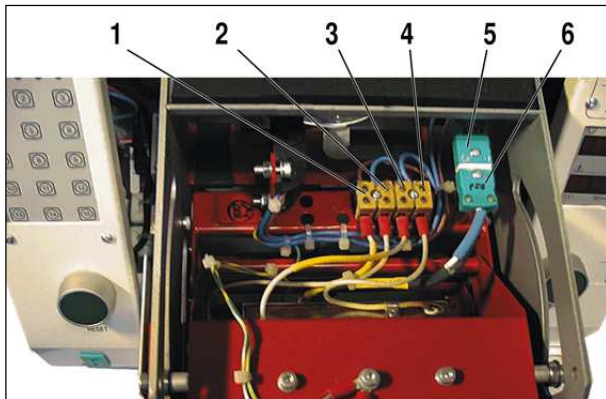

Fig. 4-7: Heater chamber Fully Forward

3. **Pull the heater chamber forward to the 1st position (Figure 4.6.). Pull the heater blades forward to free the chamber and continue moving the heater until it is fully forward (Figure 4.7.).**
4. **Remove the upper bearing screws and bearing assembly (Figure 4.6. (1)).**



*Fig. 4-8: Electrical Connections*

**1 = Bottom Heater 3 = Top Heater 5 = Thermocouple 'J' Type Socket**

**2 = Bottom Heater 4 = Top Heater 6 = Thermocouple 'J' Type Plug**

**5. Disconnect the upper and lower heater electrical connections.**

**6. Remove the top cover from the heater thermocouple Connector Plug (Figure 4.8. (6)).**

**7. Disconnect wires from the plug. Note the polarity of the wires.**

**Note: There is only one thermocouple fitted to the lower heater which cannot be re-placed separately.**



*Fig. 4-9: Heater Removal*

**Support the top heater element while screws are removed.**

**8. Remove the two retaining screws (Figure 4.9.).**

**9. Remove top heater element from top guard.**

**10. Replacing the upper heater element is the reverse of the removal procedure.**

**Note: Ensure wires to thermocouple connector plug are reconnected with the correct polarity.**

**Note: On replacement ensure that the earth lead is connected and cable ties are fitted. Calibration must then be carried out.**

#### 4.6.6 Lower Element

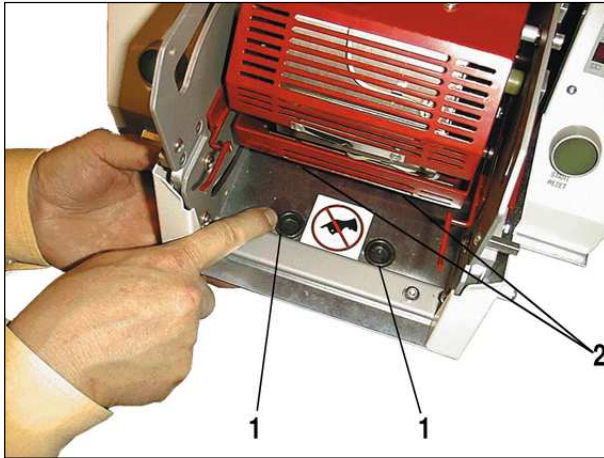

*Fig. 4-10: Gaining access to the lower retaining screws*

**1 = Access Grommets**

**2 = Heater Element Retaining Screws**

- 1. Remove the top and heater chamber panels and position the heater chamber in the forward position as previously described.**
- 2. Disconnect the heater electrical connections (Figure 4.8.).**
- 3. Disconnect the heater thermocouple Connector Plug and socket (Figure 4.8. (5)).**
- 4. Remove the grommets from base plate (Figure 4.10.) to gain access to the two lower heater element retaining screws.**
- 5. Remove the retaining screws and withdraw the lower element.**

**Note:**

**If increased access is required remove the upper heater bearing assemblies as shown in figure 4.6. And open the heater jaws.**

- 6. Replacement is the reverse of the removal procedure.**

**Note:**

**On replacement ensure that the earth lead is connected and cable ties are fitted.**



### Proximity Switch Adjustment



**ENSURE THAT MAINS SUPPLY IS DISCONNECTED.**

1. Remove the left, right and top covers. (Page 4-15).
2. Isolate the motor by disconnecting plug J3 from the PS PCB.



**WHEN POWER IS SWITCHED ON, MAINS VOLTAGES ARE PRESENT ON THE 24V DC PSU, AND POWER SWITCHING PCB.**

3. Reconnect mains supply and switch on n.
4. Identify the short vertical red tab on the heater chamber; lower left side.
5. When in the sensing position, the gap between the relevant tab and the proximity switch should be 1.5mm.



Fig. 4-11: Motor Disk Assembly

- 1 = Rotating Disk  
2 = Vertical Red Tab (Approximate Position)

#### 4.6.7 Load (Front) Proximity Sensor Adjustment

6. Rotate the motor disc (Figure 4.11.) until the heater chamber is 5° below 'top dead centre'.
7. Set the gap between the front of the proximity switch and the tab by loosening the lateral clamping screw (Figure 4.12.) and sliding the switch in or out.
8. If necessary, reposition switch mounting block to obtain correct setting by loosening the block clamping screws (Figure 4.12.).
9. Switch off the Processor and disconnect the mains supply.
10. Refit connector J3.

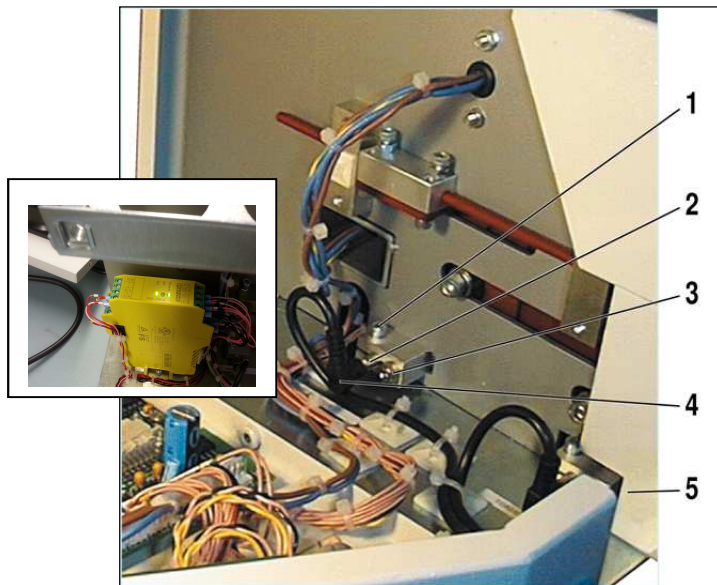

Fig. 4-12: Proximity Switch Mounting

- 1 = Lateral Clamping Screw
- 2 = LED lit when the switch is sensing
- 3 = Mounting Block Clamping Screw
- 4 = Electrical Terminal Cap
- 5 = Load (Forward) Proximity Switch

#### 4.6.8 Home (Rear) Proximity Switch

1. Move the chamber back to its rear position.
2. Adjust position of Home proximity switch as described previously for the Load switch.
3. Switch off the machine and disconnect the mains supply.
4. Refit connector J3.
5. Refit all removed covers.

#### 4.6.9 Proximity Switch Replacement

1. Pull electrical terminal cap off the proximity switch.
2. Slacken clamping screw and mounting block and withdraw switch.
3. Adjust Proximity Switch. (page 4-26 and 4-27)
4. Switch off the machine and disconnect the mains supply.
5. Refit connector J3.
6. Refit all removed covers.

#### 4.6.10 Motor Assembly Replacement

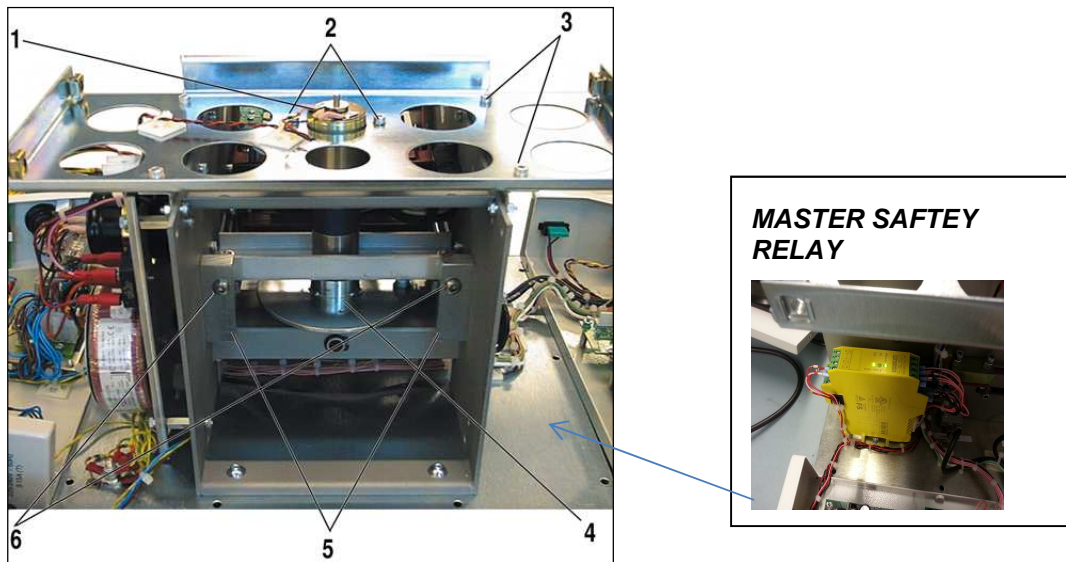
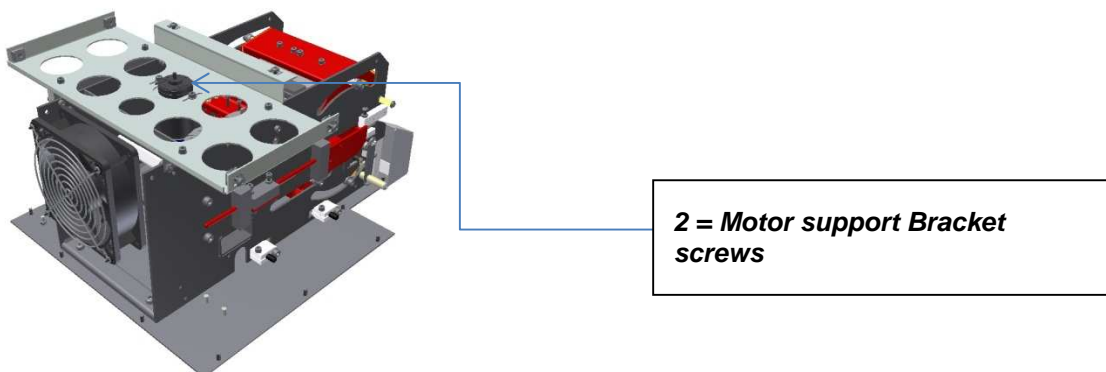

Fig. 4-13: Motor Assembly (Viewed from Rear) before fitting master relay

- 1 = Motor Electrical Connections
- 2 = Motor Support Bracket Screws
- 3 = Top Plate Retaining Screws
- 4 = Motor Assembly
- 5 = Motor Mounting Blocks
- 6 = Motor Position Adjustment Screws



#### 4.6.11 Motor Removal

With reference to Figure 4.13. And Figure 4.14.

1. Remove the side and top covers.
2. Slacken motor support bracket screws. (Do not remove).
3. Remove (de-solder) the motor electrical connections (red & black).
4. Remove the 4 top plate retaining screws and carefully remove the top plate from the processor chassis.
5. Rotate the motor crank to move the heater chamber fully forward to the (Load) position.
6. Remove the forward motor crank pivot pin retaining screw. Gain access through the hole shown in (Figure 4.14. (2)).
7. Release the M6x40 lock nuts from the adjustment screws in the motor mounting blocks and remove the screws.
8. Release the two screws which retain the motor assembly mounting plate.
9. Lift the mounting plate and remove the motor assembly from the processor.
10. Remove the rear, motor crank arm pivot pin from the motor assembly crank disk.

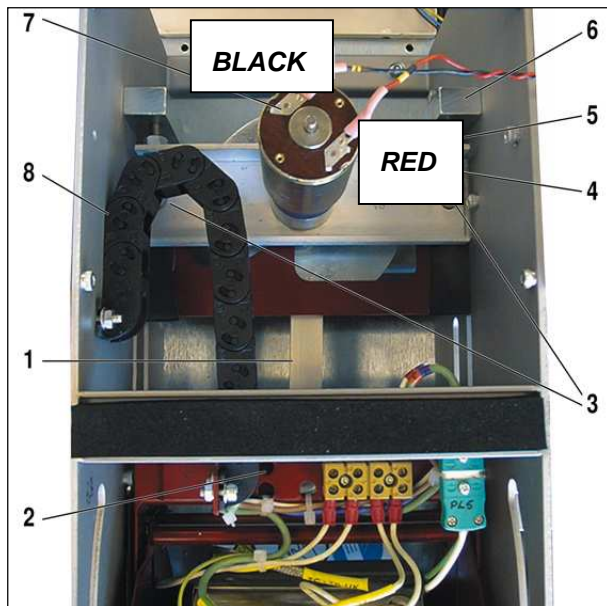

Fig. 4-14: Motor Assembly (viewed from front)

- 1 = Motor Crank Arm
- 2 = Forward Pivot Pin Access Hole
- 3 = Motor Assembly Plate Screws
- 4 = Motor Position Adjustment Screws
- 5 = M6x40 Lock Nuts
- 6 = Motor Mounting Blocks
- 7 = Motor Electrical Connections
- 8 = Cable Chain

#### 4.6.12 Motor Assemble Fitting

1. **Fit the rear motor crank arm pivot pin to the motor assembly crank disk. Use Loctite 222 on the securing screw.**
2. **Position the motor assembly mounting plate onto the chassis and fit the plate securing screws. Leave the screws finger tight.**
3. **Fit the M6x40 motor position adjustment screws and locking nuts loosely through the motor mounting blocks and mounting plate.**
4. **Move the heater chamber fully forward to the (Load) position.**
5. **Fit the forward motor crank pivot pin retaining screw to the heater chamber. Gain access through the hole shown in (Figure 4.14. (2)). Use Loctite 222 on the securing screw.**
6. **Rotate the motor crank to move the heater chamber to the rear (Home) position with the crank in the top dead centre position.**

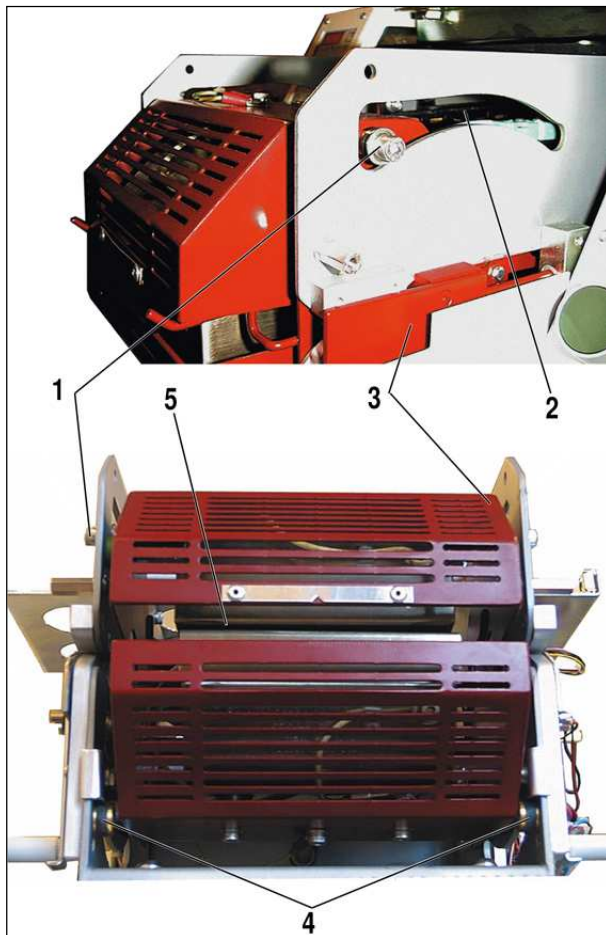
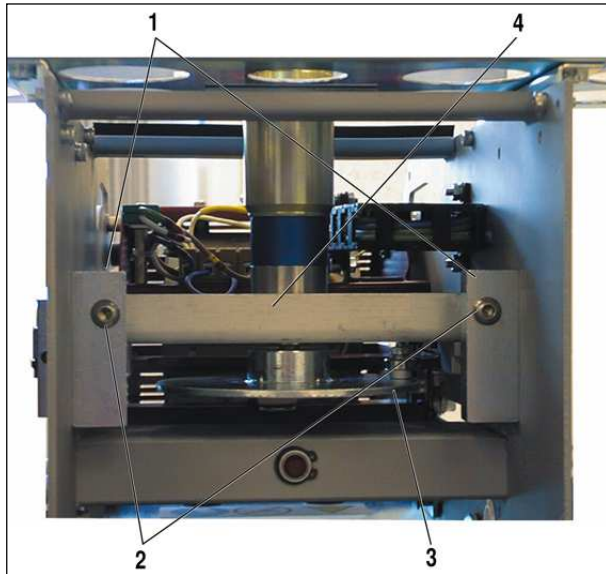

Fig. 4-15: Heater Carrier Assembly Adjustment. (Shown fully forward)

- 1 = Upper Bearing
- 2 = Chassis Bearing slots
- 3 = Heater carrier assembly
- 4 = Lower Bearing
- 5 = Heater Chamber Jaw Gap

7. **Adjust the motor assembly until the top and bottom bearings on the heater carrier assembly, are approximately 2 to 3mm from the rear of the chassis bearing slots.**
8. **Tighten the M6x40 position adjustment screw locking nuts finger tight.**
9. **Rotate the crank until the heater carrier assembly is fully forward (Load).**
10. **Check that the gaps from the upper and lower bearings to the forward chassis bearing slots are equal left and right. The clearance should be approximately the same as in the rear position, 2 to 3mm.**



*Fig. 4-16: Motor Assembly Position Adjustment (viewed from rear)*

- 1 = Motor Mounting Blocks
- 2 = Motor Position Adjustment Screws
- 3 = Motor Assembly Crank Disk
- 4 = Motor Assembly Plate

11. **Move the heater carrier to the Home and Load position as required. Adjust the setting of the motor position adjustment screws until the left and right clearances are approximately the same front and back.**
12. **Check that the heater chamber jaw gap is parallel in the Load position. Make fine adjustments to the motor position screws if necessary.**
13. **Tighten the M6x40 motor assembly plate screws.**
14. **Tighten the M6x40 adjustment screw locking nuts.**
15. **Fit the top plate and secure. Position and tighten the motor support bracket screws. (Figure 4.13. 2 & 3).**
16. **Solder the red and black wires to the motor electrical connections. Insulate with a protective sleeve.**
17. **Refit panels.**

#### 4.6.13 Cooling Fan Replacement

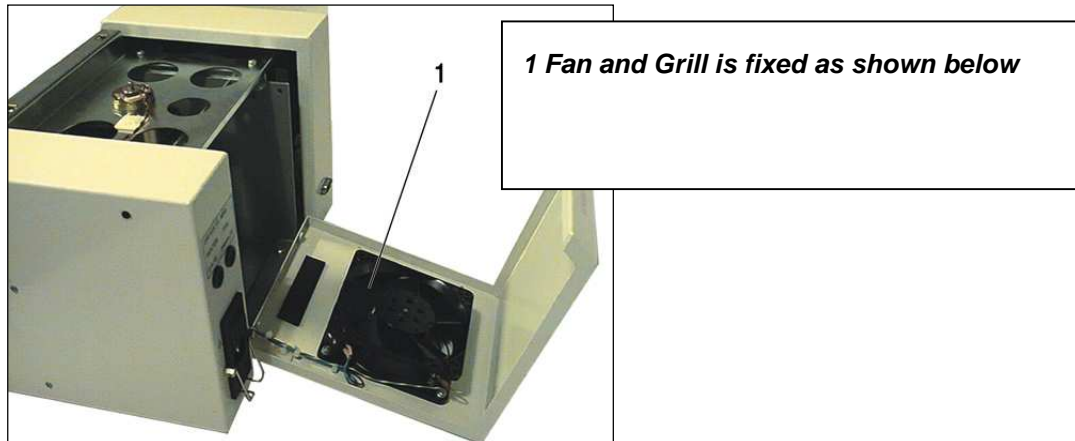
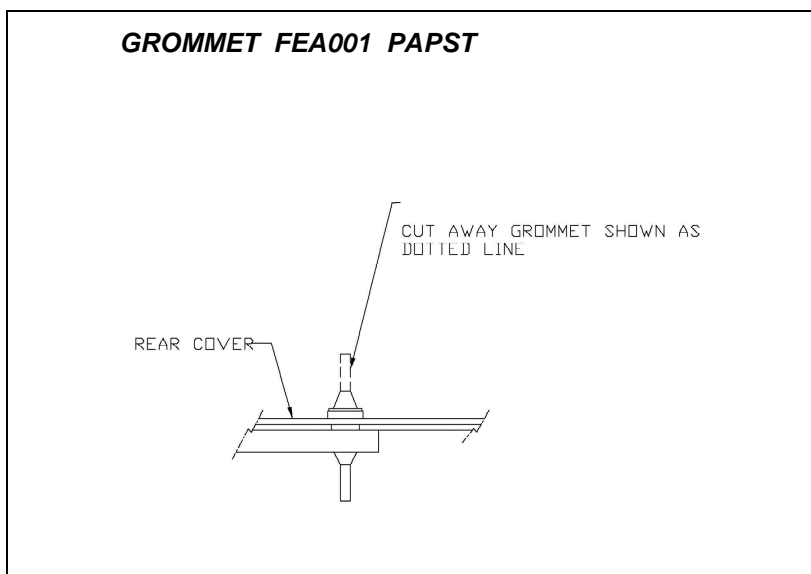

Fig. 4-17: Cooling Fan Location

##### 1 Fan

1. Remove the top and back cover.
2. Locate the Fan power cables (blue & Brown). De-solder connections.
3. Disconnect earth connection to fan chassis.
4. Note the orientation of Fan. Label at bottom right indicates direction of air movement and rotation.
5. Remove FAN unit and protection grill from top cover.
6. Replacing the Fan is the reverse of the removal procedure.
7. Ensure that the orientation of the fan is the same as in step 4.
8. Ensure air movement is from front to rear of Processor.



#### 4.6.14 24V DC Power Supply Replacement/Motor PSU Assembly



Fig. 4-18: 24V DC PSU Location

- 1 = PSU Assembly Retaining Screws
- 2 = Rectifier Bridge Earth Cable
- 3 = Chassis Earth Cable
- 4 = Power Switching PCB

1. Remove right side cover.
2. Identify the upper and lower connectors fitted to the PSU.
3. Depress retaining latch on each connector and disconnect.
4. Remove the wiring from the cable ties.
5. Remove the earth connection to the bridge rectifier.
6. Remove PSU mounting plate retaining screws and remove the PSU Assembly. (Figure 4.18.(1)).

**Note:**

The lower right screw also has the chassis earth connection wire.

7. On the new assembly check that the connected wiring is correct.  
Transfer wiring from the old assembly as required, before fitting.
8. Fitting of the new PSU assembly is the reverse of removal.



Ensure that the chassis and rectifier bridge Earth are re-connected..

9. Re-secure the cables to the wiring loom.



#### 4.6.15 Generic Controller PCB/EPROM Replacement



The Controller PCB contains static sensitive devices. Special handling techniques must be observed, e.g. wrist strap connected to earth via 1M ohm resistor.

To gain access the "SafetyRelay pcb "must be removed.item 8.

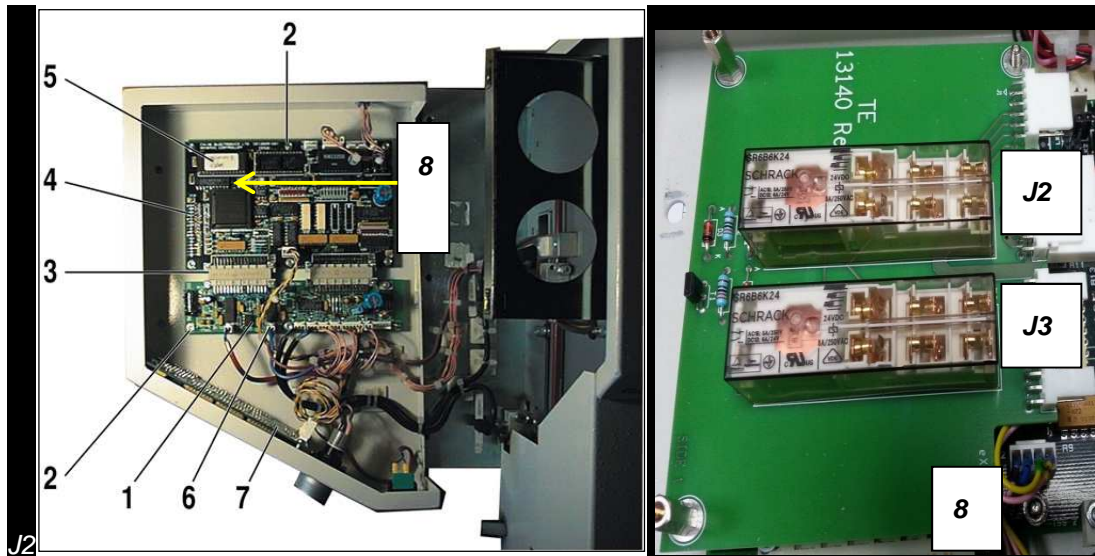

Fig. 4-19: Generic Controller PCB Removal

- 1 = Thermocouple Interface PCB
- 2 = PCB Retaining Nuts
- 3 = PCB Linking Connector
- 4 = Generic Controller PCB
- 5 = Software EPROM U3
- 6 = Thermocouple Compensating Cable
- 7 = Temperature Display
- 8 = Safety Relay PCB

Safety relay sits on top of Generic controller PCB. The same fixing screws /nuts used for the Generic PCB. Identify connectors J2 and J3. Disconnect by depressing the retaining latch on each connector. Remove board.

1. Remove left side cover.
2. Identify connectors J2 (Temperature Display) and J7 (RS232 Interface) disconnect by depressing the retaining latch on each connector.
3. Remove the six retaining nuts from the GC PCB.(Figure 4.19.(2)).
4. Remove the three retaining nuts from the TI PCB.
5. Ease both boards away from the securing studs.
6. When clear the inter-connecting plugs and sockets can be separated.
7. Replacement of the GC PCB is the reverse of removal.
8. Carry out a functional check of the Processor operation and check Parameters. (Refer to "Operation" on page 3-2)
9. Calibrate the Processor to set the temperature offset value before returning it to normal operation.

#### 4.6.16 GC PCB EPROM Replacement

*The Software EPROM (Figure 4.19.(5) can be replaced or upgraded without removing the GC PCB. Ensure static electricity precautions are maintained and the correct removal/insertion tool is used. Carry out a processor functional check from Step 9.) After replacement.*

#### **Thermocouple Interface PCB Replacement**



*The TI PCB contains static sensitive devices. Special handling techniques must be observed, e.g. wrist strap connected to earth via 1M ohm resistor.*

1. *Remove the left side cover*
  
2. *Locate the TI PCB. (Figure 4.19.)*
3. *Disconnect the eight connectors to the PCB. (depress the retaining latch on each connector)*
4. *Remove the six retaining nuts from the GC PCB.*
5. *Remove the three retaining nuts from the TI PCB.*
6. *Ease both boards away from the securing studs.*
7. *Separate the inter-connecting plugs and sockets.*
8. *Replacement of the TI PCB is the reverse of removal.*
9. *Carry out a full functional check of the Processor operation and set Parameters. (Refer to "Operation" on page 3-2)*
10. *Calibrate the Processor to set the temperature offset value before returning it to normal operation.*

#### **4.6.17 Thermocouple Compensating Cable Replacement**

- 1. Remove the power cord.**
- 2. Remove top/back and heater chamber covers.**
- 3. Remove the left side cover.**
- 4. Rotate the motor disc to drive the heater chamber to the forward position.**
- 5. Separate the two halves of the thermocouple connector (Fig 4.8. (SKT5)) And disconnect the wires from the socket. Take note of the polarity of the connecting wires.**
- 6. Trace the route of the thermocouple connecting cable from the SKT5 to connector J3 on the thermocouple interface PCB (Fig 4.19.).**
- 7. Remove the defective cable from the loom.**
- 8. Fit and secure the new cable into the loom. Make the relevant connections at both ends ensuring the correct polarity.**

**Note:**

**No cable ties should be within the cable chain.**

- 9. Refit the machine covers.**

#### 4.6.18 Power Switching PCB Replacement



*The Power Switching PCB contains static sensitive devices. Special handling techniques must be observed, e.g. wrist strap connected to earth via 1M ohm resistor.*

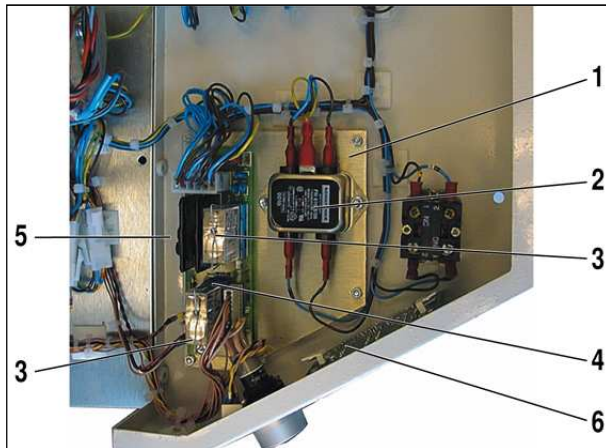

*Fig. 4-20: Power Switching PCB Removal*

- 1 = Power Switching PCB and Mains Filter Mounting Plate*
- 2 = Mains Filter*
- 3 = Isolation Relays*
- 4 = Power Switching PCB*
- 5 = Solid State Relays*
- 6 = Timer Display Assembly*

- 1. Remove the right side cover.**
- 2. Locate the PS PCB shown in Figure 4.20.**
- 3. Identify connectors J1 to J4 and disconnect, depressing the retaining latch on each connector.**
- 4. Locate and remove the Earth connection.**
- 5. Remove the four retaining nuts securing the PCB to the filter mounting plate.**
- 6. Ease the PCB from the mounting studs.**
- 7. Replacement of the TI PCB is the reverse of removal.**
- 8. Carry out a full functional check of the Processor operation.**

#### 4.6.19 Isolation Relay Replacement

Two power isolation relays RL1 and RL4 are fitted to the PS PCB, these provide the power switching for the Motor and Heater Elements.

The relays are of the plug in type located in holders.

1. To remove the relays the PCB does not have to be removed from the Processor.
2. Release the spring clip holding the relay to the base.
3. Pull the relay out of the base.
4. Fitting is the reverse of removal.

#### 4.6.20 Solid State Isolator Replacement

The Solid State Isolators are encapsulated devices soldered directly to the PCB.

1. In the event of a failure replace the PCB, follow the "Power Switching PCB Replacement" on page 4-37

#### 4.6.21 Mains Filter Replacement

The Mains Filter is a sealed unit fitted to the mounting plate shown in Figure 4.20.

1. Remove the right side cover.
2. Disconnect the two Line (brown) and Neutral (blue) wires from the filter by pulling off the fast-on connectors.
3. Disconnect the larger Earth (yellow/green) connector.

**Note:**

**It may be easier to first remove the filter plate by removing the four retaining screws from the right side cover.**

4. Remove the two retaining nuts from the filter. Remove filter from the filter plate.
5. Replacement of the Mains Filter is the reverse of the removal procedure. (Fit the device to the filter plate before fitting the assembly to the right cover)



**Ensure that when electrically connecting the Mains Filter the LINE NEUTRAL and EARTH connections are on the correct terminals.**

#### 4.6.22 Temperature Display Panel Replacement



*The Temperature Display Panel PCB contains static sensitive devices. Special handling techniques must be observed, e.g. wrist strap connected to earth via 1M ohm resistor.*

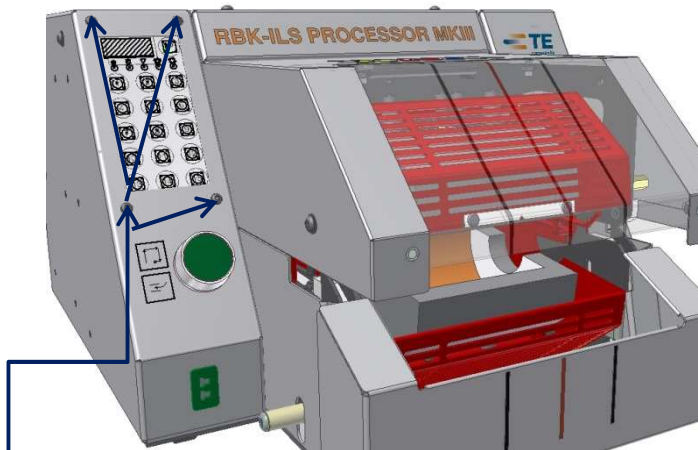

*Fig. 4-21: Temperature Display Panel Removal*

**1 = Temperature Display Securing Screws**

- 1. Remove the left side cover.**
- 2. Locate the TDP refer to Figure 4.19. (7)**
- 3. Disconnect connectors J1 (GC PCB) and J2 (TDP).**
- 4. Remove the four screws securing the TDP to the left hand cover (Figure 4.21.)**
- 5. Remove the TDP carefully.**
- 6. Replacement of the TDP is the reverse of the removal procedure.**
- 7. Test the TDP by restoring power.**
- 8. Operate the Processor for a normal cycle. Note the state of the LED indications.**
- 9. Check that each one of the fifteen cycle selector keys operates normally.**

#### 4.6.23 Process Time Display Panel Replacement



**The Process Time Display Panel PCB contains static sensitive devices. Special handling techniques must be observed, e.g. wrist strap connected to earth via 1M ohm resistor.**

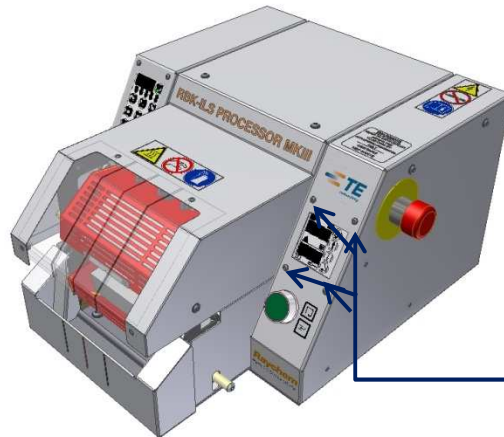

Fig. 4-22: Process Time Display Panel Removal

1 = Timer Display Securing Screws

1. **Remove the right side cover.**
2. **Locate the PTDP assembly refer to Figure 4.20. (7).**
3. **Disconnect connector J1 (TDP).**
4. **Remove the four screws securing the PTDP to the left hand cover (Figure 4.22.).**
5. **Remove the PTDP carefully from the right cover.**
6. **Replacement of the PTDP is the reverse of the removal procedure.**
7. **Test the PTDP by restoring power to the Processor in the normal way.**
8. **Operate the Processor for a normal cycle. Note the time, temperature, product code and cycle key number give the correct indications.**

## 4.7 Maintenance

### 4.7.1 Electrical Safety Checks

*Tyco Electronics recommend a yearly, or a periodic servicing, and EARTH BONDING checks. Use a Portable Appliance Tester (PAT).*

**Note:**

*The following procedure is intended as a guide only. Refer to the manufacturer's literature for the PAT tester, before proceeding with any testing.*



**Do not carry out an INSULATION RESISTANCE check using the PAT tester, as this will result in damage to the equipment.**

Checks are as follows:

1. Check that the twelve screws securing top and side covers to base (Figure 4.3.) are tight.
2. Connect the PAT to the mains supply. Select EARTH BONDING, 10A

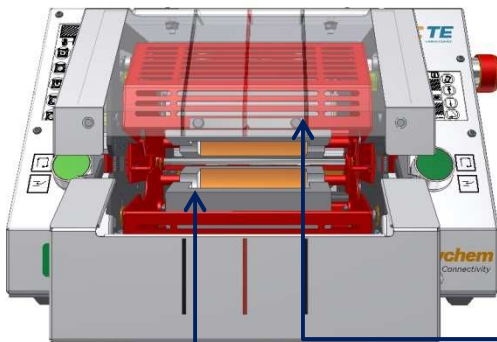

Fig. 4-23:  
Heater Element Test Points

**b = Bottom heater element**

**a = Top heater element**

3. Place test probe firmly on each of the four test points in turn, as listed below (see Figures 4.23., 4.24., 4.25.). Press TEST for 10 seconds, check resistance remains at not greater than 0.225 ohms for the 10 seconds.

- a) Top heater element
- b) Bottom heater element
- c) Base-plate accessed from front of machine
- d) Stud securing Perspex cover of heater chamber.

- F) Check nuts are tight on earth bonding Studs.



Fig. 4-24: Base Plate Test Point

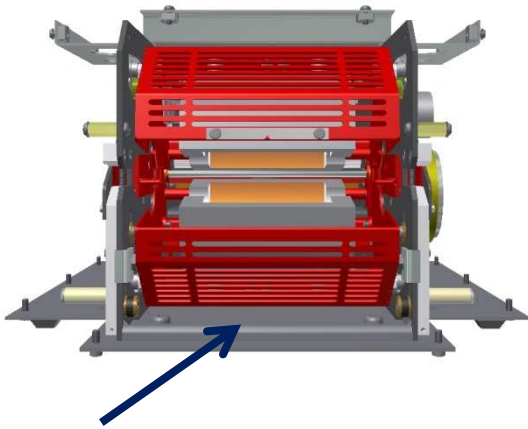

**c = Base-plate accessed from front of machine**

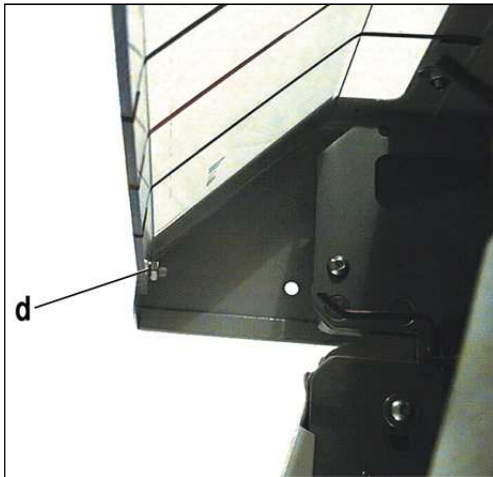
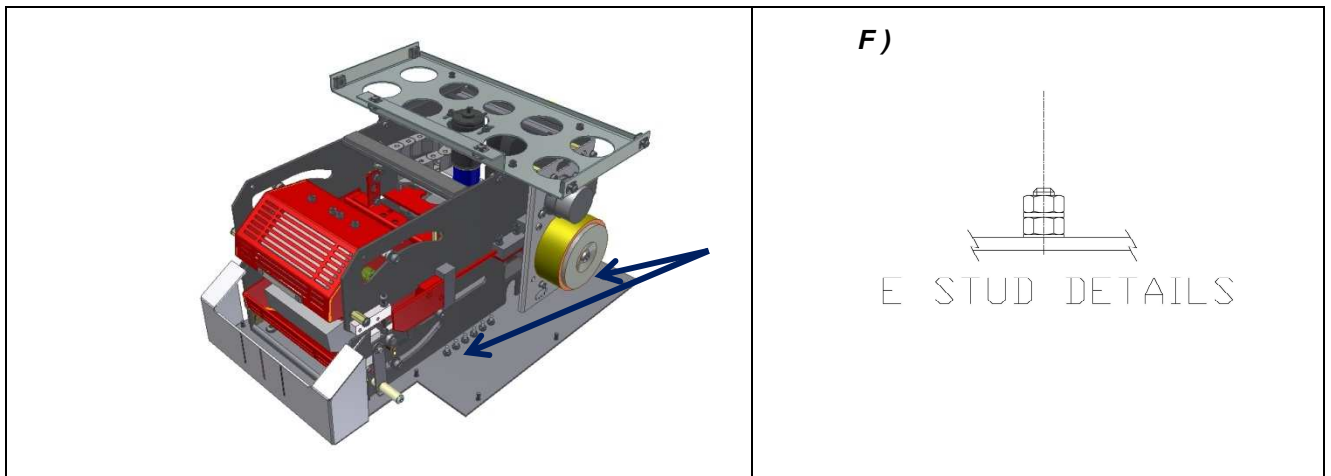

Fig. 4-25: Perspex Cover Screw **d = Stud securing Perspex cover of heater chamber**



#### 4.7.2 Maintenance

The RBK- ILS Processor MK3 requires only the minimum of maintenance. However, the following checks must be carried out on a weekly basis:



- a) **Cooling Fan.** Switch the Processor from the Stand-by to operating mode. Check that fan starts working when 200°C is reached on the Temperature display, and air is flowing through rear vent panel.
- b) **Wire Grippers.** Check visually for correct operation and signs of wear.
- c) **Manual Release.** Check that manual release levers (Figure 1.2. page 1-3) operate freely

#### 4.7.3 Temperature Calibration

Processor Calibration is to be checked before first use, on monthly basis and after long periods of not in use. Calibration is also required if the heater, GC PCB or TI PCB is replaced.

For Auto Calibration of the RBK- ILS Processor MK3 the tools required to do this are “highlighted” in

**YELLOW.**

For Manual/Auto calibration a kit can be ordered from TE/Tyco//Raychem “highlighted” in **Turquoise**

Order information below highlighted in **GREY** a complete kit with a needle probe can be purchased to calibrate RBK- ILS Processor MK3 and other TE Application tooling. Example: CV-OBHAT.







Ordering information:



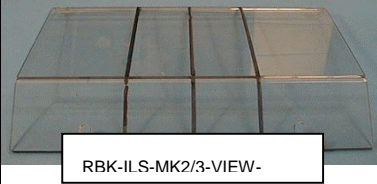

<b>RBK-Temp-Calibration-Kit</b>	<b>684947-000</b>	Temperature calibration kit containing meter, UHI probe + cable & needle probe	
<b>RBK-TEMP-CAL-KIT-UHI</b>	<b>A12192-000</b>	Temperature calibration kit containing meter, UHI probe + cable	
<b>CLT-Equip-UHI-250A-1-PRB</b>	<b>288869-000</b>	Standard UHI temperature calibration probe	
<b>CLTEQ-UHI250-EXT-CABL</b>	<b>952687-000</b>	Extension cable	

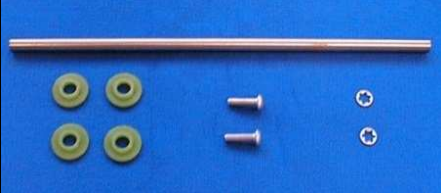

Follow the procedure described on page 4-9.for calibration.

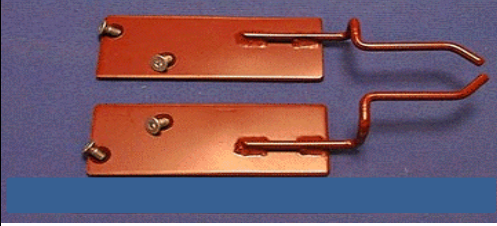
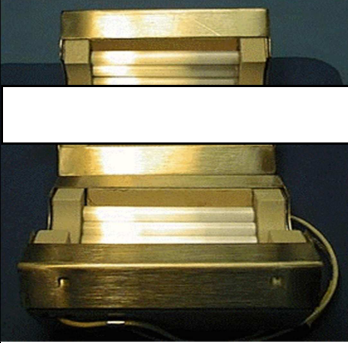
## 4.8 Recommended Spares

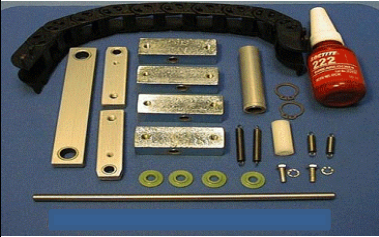
The following list contains the spare parts available for the RBK- ILS Processor MK3.

 <b>Description</b>	<b>Description</b>	<b>Part-No.</b>	<b>Supplier</b>
<b>RBK-Proc-Mk3-Processor</b>	<b>Main Equipment *</b> 	<b>529535-1</b>	<b>TE/Tyco Electronics</b>
<b>RBK-ILS-MK2/3-VIEW-WINDOW</b>	<b>Replacement lockable cover window</b> 	<b>496043-000</b>	<b>TE/Tyco Electronics</b>
<b>RBK-ILS-MK2/3-PROX-SW</b>	<b>Replacement front and back proximity sensor</b> 	<b>492905-000</b>	<b>TE/Tyco Electronics</b>
<b>RBK-ILS-MK2/3-HTR-PIVT-ASSY</b>	<b>Replacement heater pivot assembly</b> 	<b>014395-000</b>	<b>TE/Tyco Electronics</b>
<b>RBK-ILS-MK2/3-BEAR-REP-KIT</b>	<b>Heater chamber replacement bearing kit</b> 	<b>870779-000</b>	<b>TE/Tyco Electronics</b>

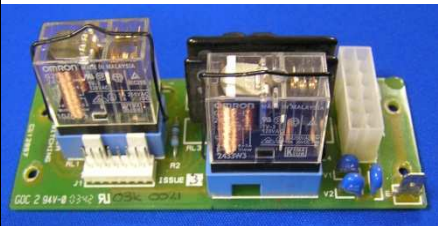
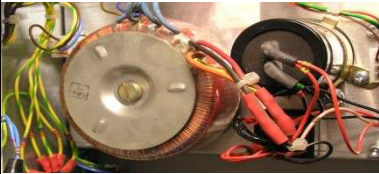
<b>RBK-ILS-MK2/3-EJECT-BL-SET</b>	<b>Replacement ejector blade set</b> 	<b>690523-000</b>	<b>TE/Tyco Electronics</b>
<b>RBK-ILS-MK2/3-ELEM-ASSY</b>	<b>Replacement heating element</b> 	<b>342551-000</b>	<b>TE/Tyco Electronics</b>
<b>RBK-ILS-MK2/3-FAN</b>	<b>Replacement cooling Fan</b> 	<b>250145-000</b>	<b>TE/Tyco Electronics</b>
<b>RBK-ILS-MK2/3-MECH-REP-KIT</b>	<b>Mechanical repair kit</b> 	<b>883491-000</b>	<b>TE/Tyco Electronics</b>
<b>RBK-ILS-MK2/3-MOTOR-ASSY</b>	<b>Replacement motor</b> 	<b>858752-000</b>	<b>TE/Tyco Electronics</b>

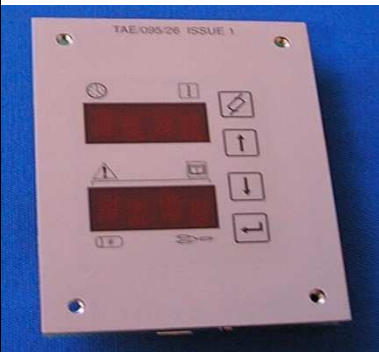
<b>RBK-ILS-MK2/3-PWR-SW-ASSY</b>	<b>Power switching assembly</b> 	<b>537221-1</b>	<b>TE/Tyco Electronics</b>
<b>RBK-ILS-MK2/3-MOT-PSU-ASSY</b>	<b>Motor PSU assembly</b> 	<b>537221-3</b>	<b>TE/Tyco Electronics</b>
<b>RBK-ILS-MK2/3-GEN-CONT-PCB</b>	<b>Generic controller PCB</b> 	<b>537221-2</b>	<b>TE/Tyco Electronics</b>
<b>RBK-ILS-MK2/3-INTFC-PCB</b>	<b>Thermocouple interface PCB</b> 	<b>537221-4</b>	<b>TE/Tyco Electronics</b>
<b>RBK-ILS-MK2/3/CV-OBHAT-TIMER-MODULE</b>	<b>Timer module</b> 	<b>3-529533-3</b>	<b>TE/Tyco Electronics</b>

<p><b>RBK-ILS-MK2/3-TMP-CONT-MOD</b></p>	<p><b>Temperature control module</b></p> 	<p><b>3-529533-4</b></p>	<p><b>TE/Tyco Electronics</b></p>
<p><b>RBK-ILS-MK2/3-EL-COVR-ASSY</b></p>	<p><b>Element cover assembly</b></p> 	<p><b>478274-000</b></p>	<p><b>TE/Tyco Electronics</b></p>
<p><b>RBK-ILS-Mk3-Eprom</b></p>	<p><b>Software EPROM Version 2</b></p>	<p><b>1-537221-0</b></p>	<p><b>TE/Tyco Electronics</b></p>
<p><b>RBK-ILS-Mk2/3-EJ-Bush-Kit</b></p>	<p><b>Ejector bush kit</b></p> 	<p><b>F20689-000</b></p>	<p><b>TE/Tyco Electronics</b></p>

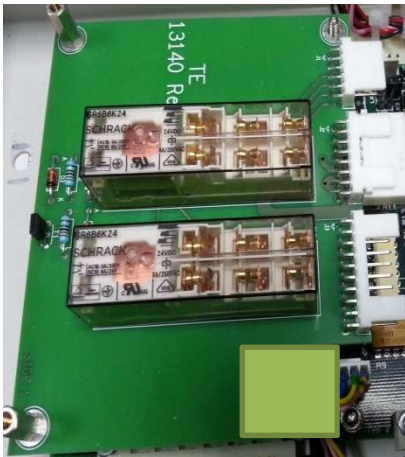
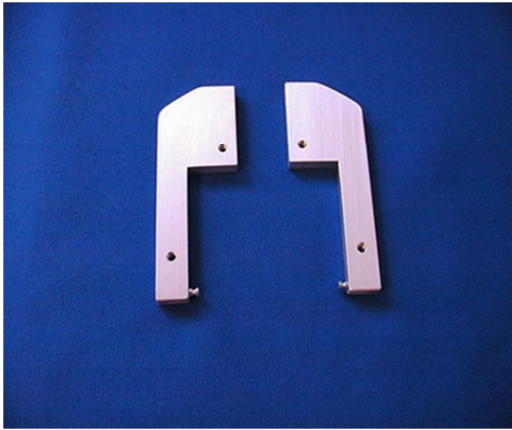
<p><b>RBK-ILS-MK3-PCB-SAFETY-RELAY</b></p>	<p><b>Safety Relay PCB</b></p> 	<p><b>537221-8</b></p>	<p><b>TE/Tyco Electronics</b></p>
<p><b>RBK-ILS-MK2/3-PROC-PIN-BLOC-REP</b></p>	<p><i>The kit consists of 2 off moving pinch blocks. Both fitted with spring anchor pins.</i></p> 	<p><b>924745-000</b></p>	<p><b>TE/Tyco Electronics</b></p>

Description	Description	Part-No.	Supplier
<b>Mains inlet socket</b>	<b>IEC Input Plug and fuse assembly</b>	<b>151-747</b>	<b>Farnell</b>
<b>* Fuse 3.15A T (anti-surge)</b>	<b>Mains input fuses x 2 - Rear panel mains connector</b>	<b>1123247</b>	<b>Farnell</b>
<b>* Fuse 100mA T (anti-surge)</b>	<b>Cooling fan fuse - Rear panel</b>	<b>1241961</b>	<b>Farnell</b>
<b>* Fuse 2A T (anti-surge)</b>	<b>Heating element fuse - Rear panel</b>	<b>534-195</b>	<b>Farnell</b>
<b>* Note: Only use fuses which conform to BS4265 or IEC127</b>			
<b>EMC Filter FN610-6/06</b>	<b>Mains filter</b>	<b>230-560</b>	<b>Farnell</b>
<b>Emergency Stop Switch</b>			
	<b>Emergency Stop Push button</b>	<b>ZB2-BS44</b>	<b>Telemechanique</b>
	<b>Contact Block</b>	<b>ZB2-BZ104</b>	<b>Telemechanique</b>
<b>Cycle Start Button</b>			
	<b>Switch Push Button</b>	<b>14-132.0252</b>	<b>Supplier see below under EAO</b>
	<b>Aluminium Ring</b>	<b>704-6001</b>	
	<b>Green Cap</b>	<b>704-6015</b>	
<b>Accessories</b>			
<b>RBK-ILS-Proc-Termfix-08mm 08mm</b>	<b>stub splice adaptor</b>	<b>049857-000</b>	<b>Tyco Electronics</b>
<b>SAFETY RELAY</b>	<b>PSR-SCP- 24UC/THC4/2X1/1X2</b>	<b>2064570</b>	<b>Farnell</b>
<b>RBK-ILS-Proc-Air-Cool-Kit</b>	<b>Air cooled stub splice support fixture.</b>	<b>1-529533-7</b>	<b>Tyco Electronics</b>
<b>Comms Link Cable</b>	<b>Cable required for comms link between MK3 processor and ultrasonic welder software. The required cable is a 9-pin female 'D' type connector with the pins wired 1 to 1</b>	<b>758-7541 1m 758-7545 2m</b>	<b>RS Components RS Components</b>



#### **4.8.1 Supplier- web-sites**

##### ***Farnell.***

*<http://www.farnell.com/>*

##### ***Telemechanique***

*<http://www.schneider-electric.co.uk>*

##### ***EAO***

*<http://www.eao.com>*

## 5. Technical Details

### 5.1 Specification

<b>RBK- ILS Processor MK3</b>	
<b>Electrical Supply</b>	<b>220/240 V - 50 Hz</b>
<b>Power Consumption</b>	<b>1,7 A (Maximum)</b>
<b>Operating Temperature Range</b>	<b>200°C to 600°C Maximum (Acc. <math>\pm 1^\circ\text{C}</math> of set temperature) 500°C Recommended</b>
<b>Typical Machine Cycle Times for ILS-125 Products used on typical range of automotive splices. QSZH product installs faster than the ILS-125 Product</b>	<b>Range 0.1 to 99.9 seconds Typically 2-34 seconds, depending on wire size and number of wires used.</b>
<b>Mains Fuses</b>	<b>2 x 240V - 3.15A T (anti-surge) Line and Neutral</b>
<b>Motor Internal Protection Device (Poly-switch)</b>	<b>30V - Trip - 1.1 to 2.2 amp continuous &lt; 30 sec. Power off reset - 1 minute.</b>
<b>Product Range</b>	<b>RBK-ILS-125/QSZH Sizes 1 to 3A RBK-ILS-85 Sizes 6/1 to 12/3 (For other Raychem/TE/TYCO Products Discuss with TE Product Management)</b>
<b>Dimensions</b>	<b>390 mm (W) x 365 mm (D) x 225 mm (H)</b>
<b>Weight</b>	<b>18 kg</b>
<b>Noise</b>	<b>80dB Maximum (Cyclic, 1m from machine)</b>
<b>Power Failure Protection</b>	<b>Capacitor activated 'Electronic Spring' Technology (Allows Heater Chamber to be retracted automatically)</b>
<b>RS232 Interface</b>	<b>Permits transfer of Time, temperature and Product code from isolated STD. 1KV remote device.</b>



## **6. Address "After" Sales.**

**Tyco Electronics AMP GmbH  
c/o Schenck Technologie- und Industriepark GmbH  
Landwehrstr. 55 / Gebäude 83  
64293 Darmstadt / Germany  
GATD Kundendienst-Hotline: +49-6151-607-1518**