

WIDEBAND DRIVER AMPLIFIER MODULE, 2 - 35 GHz



Typical Applications

The HMC-C038 Wideband Driver is ideal for:

- Telecom Infrastructure
- Microwave Radio & VSAT
- Military & Space
- Test Instrumentation
- Fiber Optics

Functional Diagram

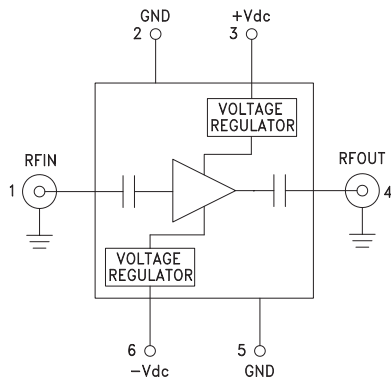

Features

- Gain: 12 dB @ 10 GHz
- P1dB Output Power: +18 dBm @ 10 GHz
- Regulated Supply and Bias Sequencing
- Hermetically Sealed Module
- Field Replaceable 2.92 mm Connectors
- 55 °C to +85 °C Operating Temperature

General Description

The HMC-C038 is a GaAs PHEMT MMIC Distributed Power Amplifier in a miniature, hermetic module with replaceable 2.92mm connectors which operates between 2 and 35 GHz. The amplifier provides 12 dB of gain, +29 dBm output IP3 and up to +18 dBm of output power at 1 dB gain compression. Gain flatness is excellent from 2 - 16 GHz making the HMC-C038 ideal for EW, ECM RADAR and test equipment applications. The wideband amplifier I/Os are internally matched to 50 Ohms and are DC blocked. Integrated voltage regulators allow for flexible biasing of both the negative and positive supply pins, while internal bias sequencing circuitry assures robust operation.

Electrical Specifications, $T_A = +25^\circ\text{C}$, $+V_{dc} = +11\text{V to } +16\text{V}$, $-V_{dc} = -4\text{V to } -12\text{V}$

Parameter	Min.	Typ.	Max.	Min.	Typ.	Max.	Min.	Typ.	Max.	Units
Frequency Range	2 - 15			15 - 27			27 - 35			GHz
Gain	9	12		8	11		6	9		dB
Gain Flatness		±0.5			±0.4			±1.5		dB
Gain Variation Over Temperature		0.02	0.03		0.02	0.03		0.02	0.03	dB/ °C
Noise Figure		3.0			4.0			6.0		dB
Input Return Loss		15			10			6		dB
Output Return Loss		15			13			13		dB
Output Power for 1 dB Compression (P1dB)	15	18		13	16		10	14		dBm
Saturated Output Power (Psat)		20			18.5			15.5		dBm
Output Third Order Intercept (IP3)		29			26			25		dBm
Positive Supply Current (+IDC)		92			92			92		mA
Negative Supply Current (-IDC)		5.3			5.3			5.3		mA

Information furnished by Analog Devices is believed to be accurate and reliable. However, no responsibility is assumed by Analog Devices for its use, nor for any infringements of patents or other rights of third parties that may result from its use. Specifications subject to change without notice. No license is granted by implication or otherwise under any patent or patent rights of Analog Devices. Trademarks and registered trademarks are the property of their respective owners.

For price, delivery, and to place orders: Analog Devices, Inc., One Technology Way, P.O. Box 9106, Norwood, MA 02062-9106
Phone: 781-329-4700 • Order online at www.analog.com
Application Support: Phone: 1-800-ANALOG-D

HMC-C038* PRODUCT PAGE QUICK LINKS

Last Content Update: 02/23/2017

COMPARABLE PARTS

View a parametric search of comparable parts.

DOCUMENTATION

Application Notes

- AN-1363: Meeting Biasing Requirements of Externally Biased RF/Microwave Amplifiers with Active Bias Controllers

Data Sheet

- HMC-C038 Data Sheet

TOOLS AND SIMULATIONS

- HMC-C038 S-Parameter

DESIGN RESOURCES

- HMC-C038 Material Declaration
- PCN-PDN Information
- Quality And Reliability
- Symbols and Footprints

DISCUSSIONS

View all HMC-C038 EngineerZone Discussions.

SAMPLE AND BUY

Visit the product page to see pricing options.

TECHNICAL SUPPORT

Submit a technical question or find your regional support number.

DOCUMENT FEEDBACK

Submit feedback for this data sheet.



**WIDEBAND DRIVER AMPLIFIER
MODULE, 2 - 35 GHz**

Gain & Return Loss

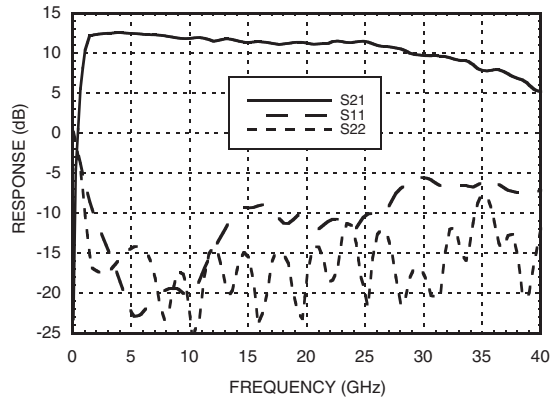

Gain vs. Temperature

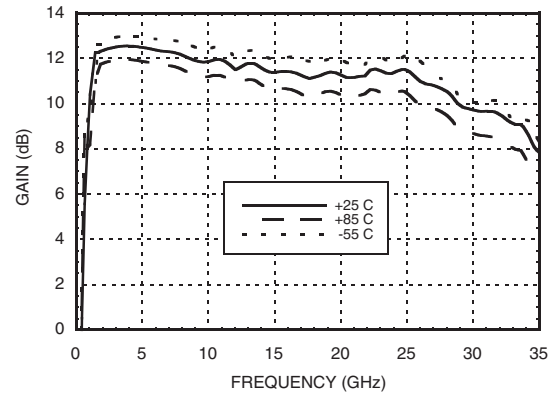

Input Return Loss vs. Temperature

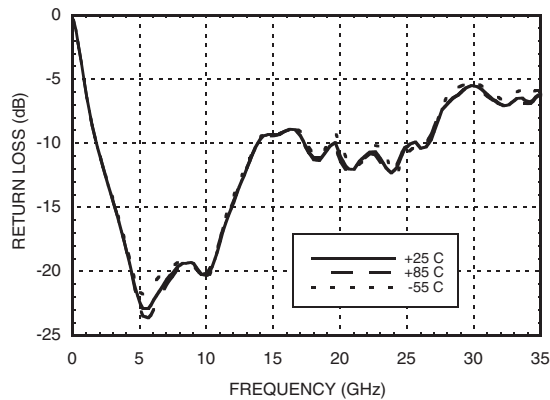

Output Return Loss vs. Temperature

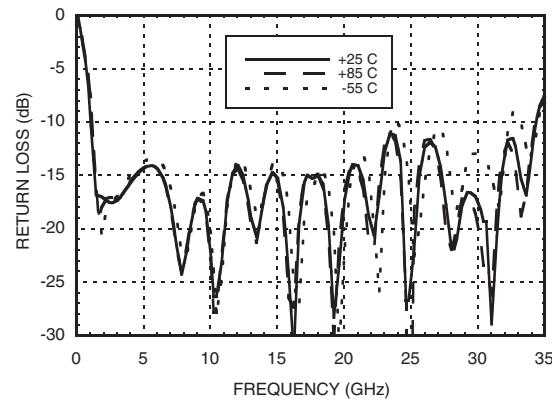

Reverse Isolation vs. Temperature

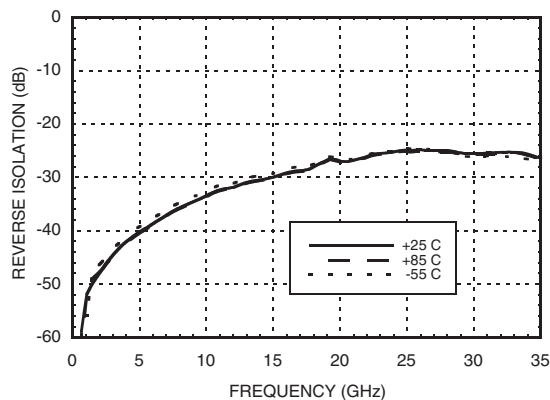

Noise Figure vs. Temperature

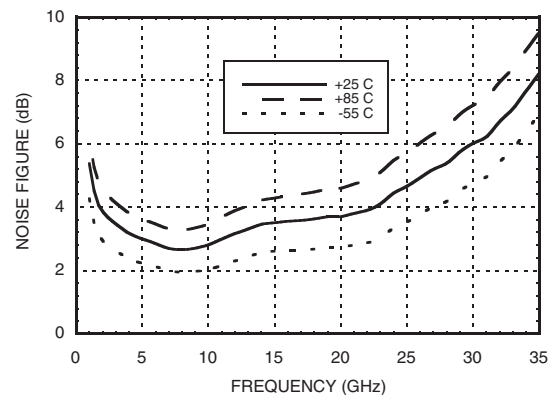

Information furnished by Analog Devices is believed to be accurate and reliable. However, no responsibility is assumed by Analog Devices for its use, nor for any infringements of patents or other rights of third parties that may result from its use. Specifications subject to change without notice. No license is granted by implication or otherwise under any patent or patent rights of Analog Devices. Trademarks and registered trademarks are the property of their respective owners.

For price, delivery, and to place orders: Analog Devices, Inc., One Technology Way, P.O. Box 9106, Norwood, MA 02062-9106 Phone: 781-329-4700 • Order online at www.analog.com Application Support: Phone: 1-800-ANALOG-D



**WIDEBAND DRIVER AMPLIFIER
MODULE, 2 - 35 GHz**

P1dB vs. Temperature

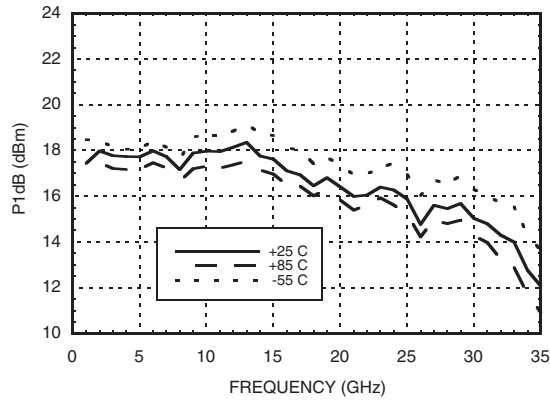

Psat vs. Temperature

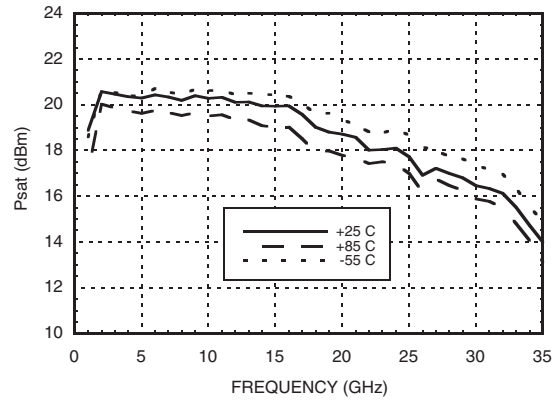

Output IP3 vs. Temperature

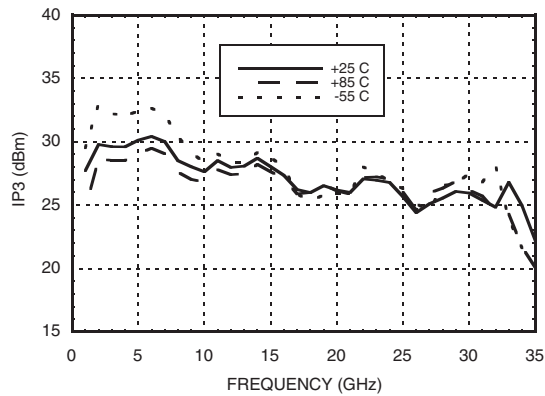

Absolute Maximum Ratings

Positive Bias Supply Voltage (+Vdc)	+17V Max
Negative Bias Supply (-Vdc)	-16V Min.
RF Input Power (RFIN)	+23 dBm
Storage Temperature	-65 to +150 °C
Operating Temperature	-55 to +85 °C



**ELECTROSTATIC SENSITIVE DEVICE
OBSERVE HANDLING PRECAUTIONS**



Information furnished by Analog Devices is believed to be accurate and reliable. However, no responsibility is assumed by Analog Devices for its use, nor for any infringements of patents or other rights of third parties that may result from its use. Specifications subject to change without notice. No license is granted by implication or otherwise under any patent or patent rights of Analog Devices. Trademarks and registered trademarks are the property of their respective owners.

For price, delivery, and to place orders: Analog Devices, Inc., One Technology Way, P.O. Box 9106, Norwood, MA 02062-9106
Phone: 781-329-4700 • Order online at www.analog.com
Application Support: Phone: 1-800-ANALOG-D

WIDEBAND DRIVER AMPLIFIER MODULE, 2 - 35 GHz

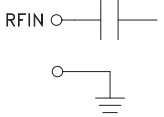

Pin Descriptions

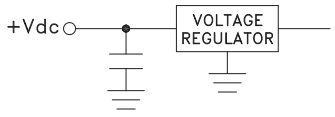
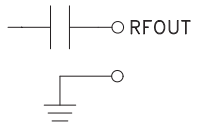
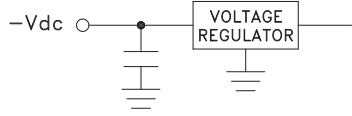
Pin Number	Function	Description	Interface Schematic
1	RFIN & RF Ground	RF input connector, 2.92 mm female, field replaceable. This pin is AC coupled and matched to 50 Ohms.	
2, 5	GND	Power supply ground.	
3	+Vdc	Positive power supply voltage for the amplifier.	
4	RFOUT & RF Ground	RF output connector, 2.92 mm female field replaceable. This pin is AC coupled and matched to 50 Ohms.	
6	-Vdc	Negative power supply voltage for the amplifier	



**WIDEBAND DRIVER AMPLIFIER
MODULE, 2 - 35 GHz**

Outline Drawing

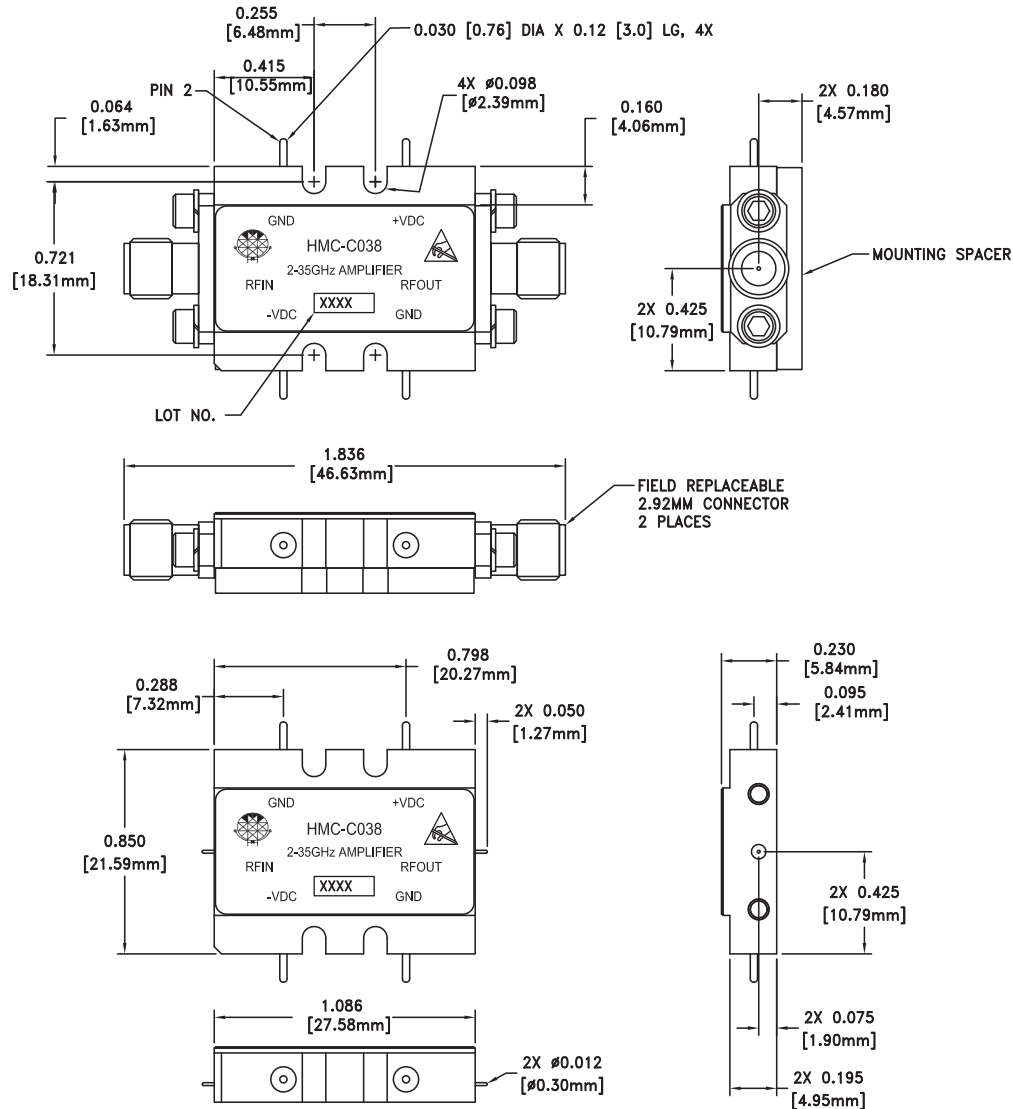

VIEW SHOWN WITH CONNECTORS REMOVED

Package Information

Package Type	C-10
Package Weight ^[1]	18.7 gms ^[2]
Spacer Weight	3.3 gms ^[2]

[1] Includes the connectors

[2] \pm 1 gms Tolerance

NOTES:

1. PACKAGE, LEADS, COVER MATERIAL: KOVAR™
2. FINISH: GOLD PLATE OVER NICKEL PLATE
3. ALL DIMENSIONS ARE IN INCHES [MILLIMETERS]
4. TOLERANCES:
 - 4.1 .XX = \pm 0.02
 - 4.2 .XXX = \pm 0.010
5. FIELD REPLACEABLE 2.92mm CONNECTORS
TENSOLITE 231CCSF OR EQUIVALENT

**WIDEBAND DRIVER AMPLIFIER
MODULE, 2 - 35 GHz****Notes:**