

## DETAILS

<b>Product Number</b>	CN12702_LENINA-W
<b>Family</b>	Lenina
<b>Type</b>	RefPack
<b>Color</b>	metal
<b>Diameter</b>	74 mm
<b>Height</b>	45,4 mm
<b>Style</b>	round
<b>Optic Material</b>	
<b>Holder Material</b>	
<b>Fastening</b>	screw
<b>Status</b>	production ready
<b>ROHS Compliant</b>	Yes
<b>Date Updated</b>	6/03/2017

## OPTICAL PROPERTIES

LED	Viewing	Light	Effi-		Connector
	Angle	Beam	ciency	cd/lm	
CLL03x/CLU03x	56 deg	Wide	90 %	1.100	-
CLU720/721	54 deg	Wide	87 %	1.000	-
CXM-14	58 deg	Wide	92 %	1.100	LEDiL: LEDiL
Soleriq S15	sim: 56	Wide	sim: 90 %	sim: 1.068	-
COB D Series LES 14.5 mm	57 deg	Wide	91 %	1.000	-
ZC12/18	57 deg	Wide	88 %	1.020	-
STARK SLE PURE G3 LES17	58 deg	Wide	89 %	1.000	-
SLE G5 LES15	57 deg	Wide	92 %	1.100	LEDiL: LEDiL



Relative intensity of CN12702\_LENINA-W

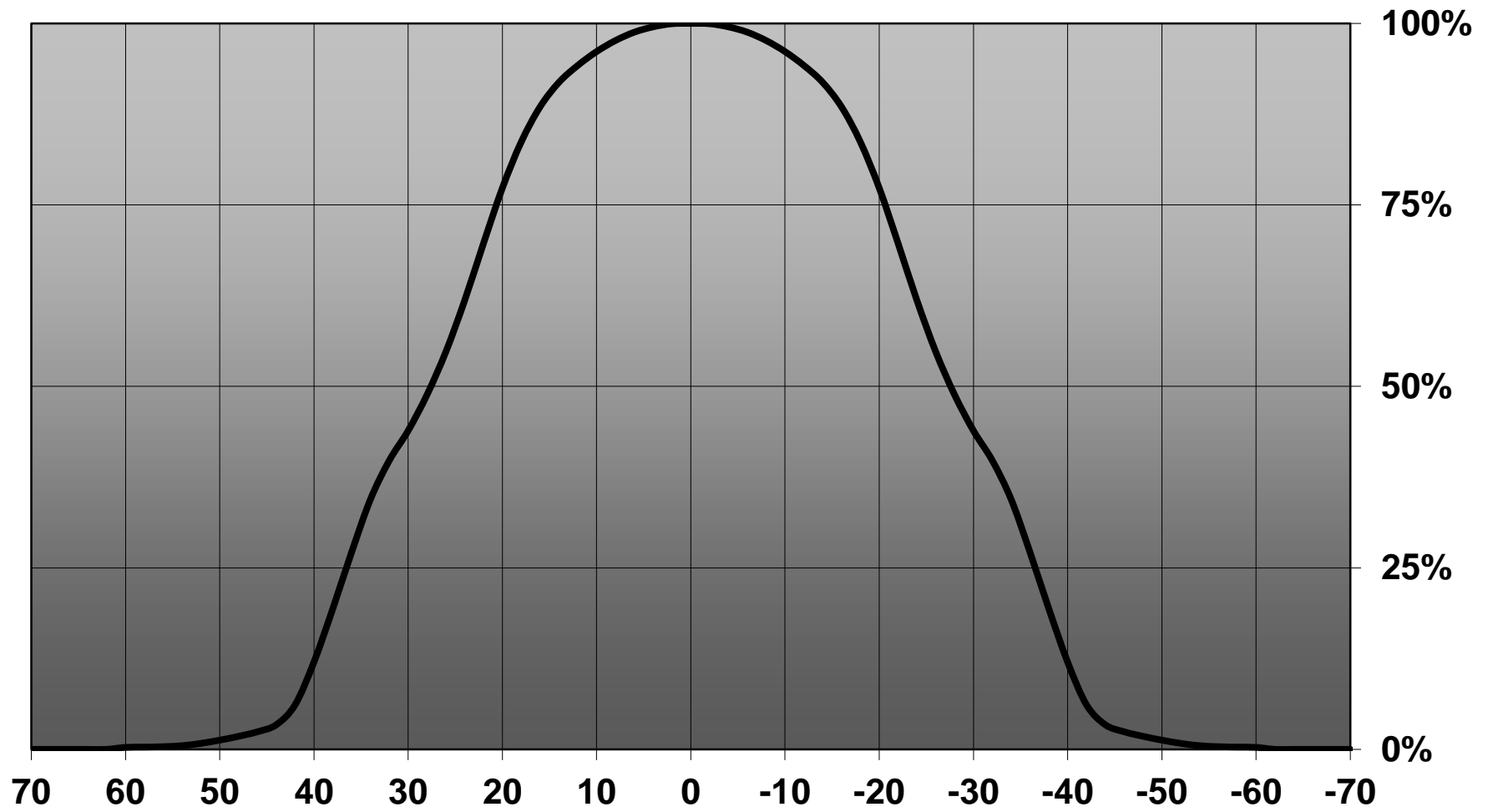

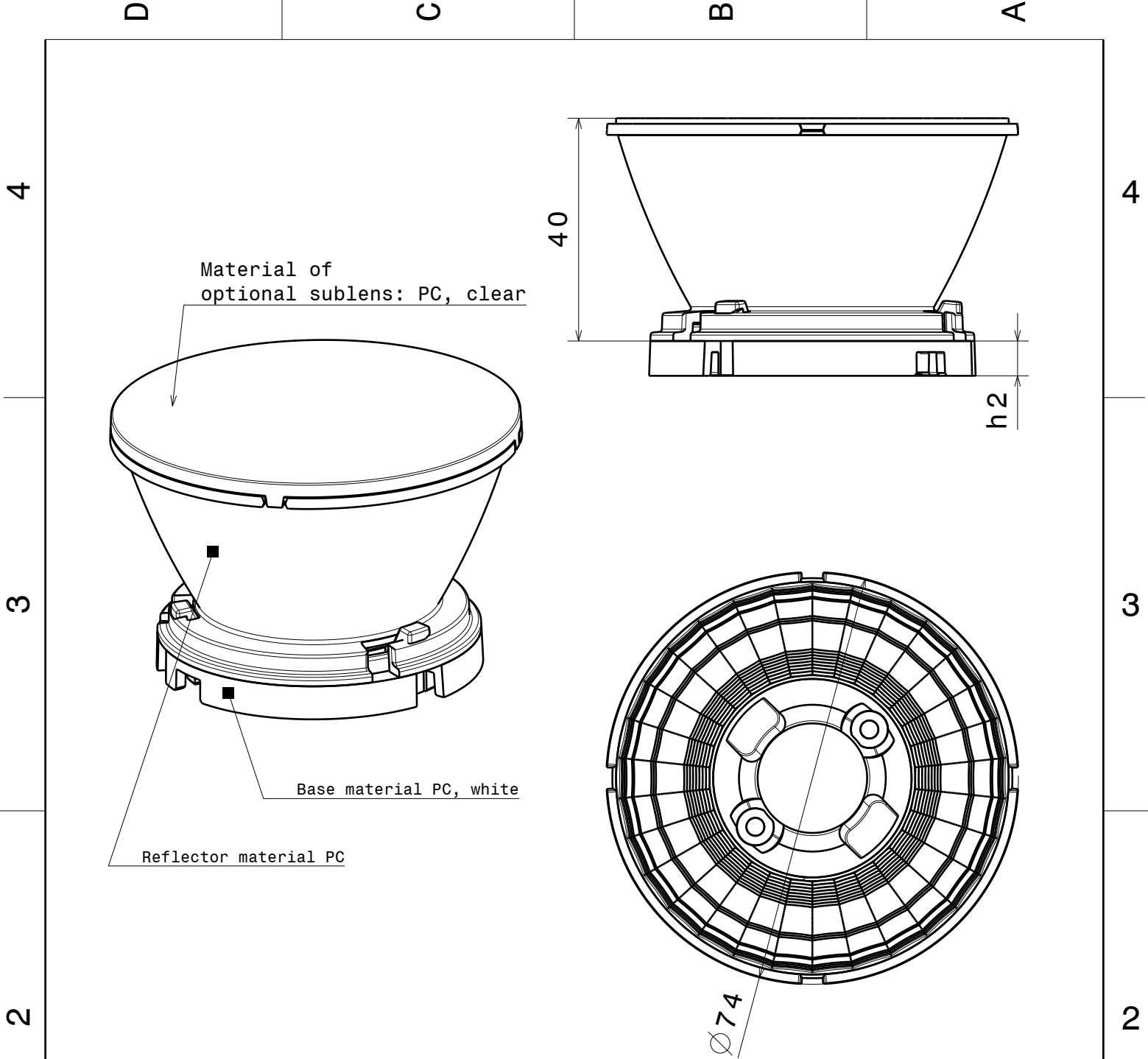

**NOTE:**

Using optional sublens, add 2.1mm to the system height

Dimension 'h2' varies from 4.5mm to 7mm depending on the LED specific base part

This drawing is our property. It can't be reproduced or communicated without our written agreement.



Ledil Oy  
Salorankatu 10  
FIN-24240 SALO  
Finland

**DRAWING TITLE**

**Datasheet Lenina series**

<b>DRAWN BY</b> ks		<b>DATE</b> 23.04.2014		<b>SIZE</b> A4		<b>DRAWING NUMBER</b> --		<b>REV</b> 1	
<b>CHECKED BY</b>		<b>DATE</b>						<b>SHEET</b> 1 / 1	
<b>DESIGNED BY</b> pl		<b>DATE</b> 08.03.2012		<b>SCALE</b> 1 : 1		<b>WEIGHT (g)</b>			

D

A

Luminaire: Ledil CN12702\_LENINA-W (CLU036)

Lamps: 1 x CLU036\_(-1208C1-303M2G2)\_1273.68lm@250mA\_P=8.24W\_I=0.25A

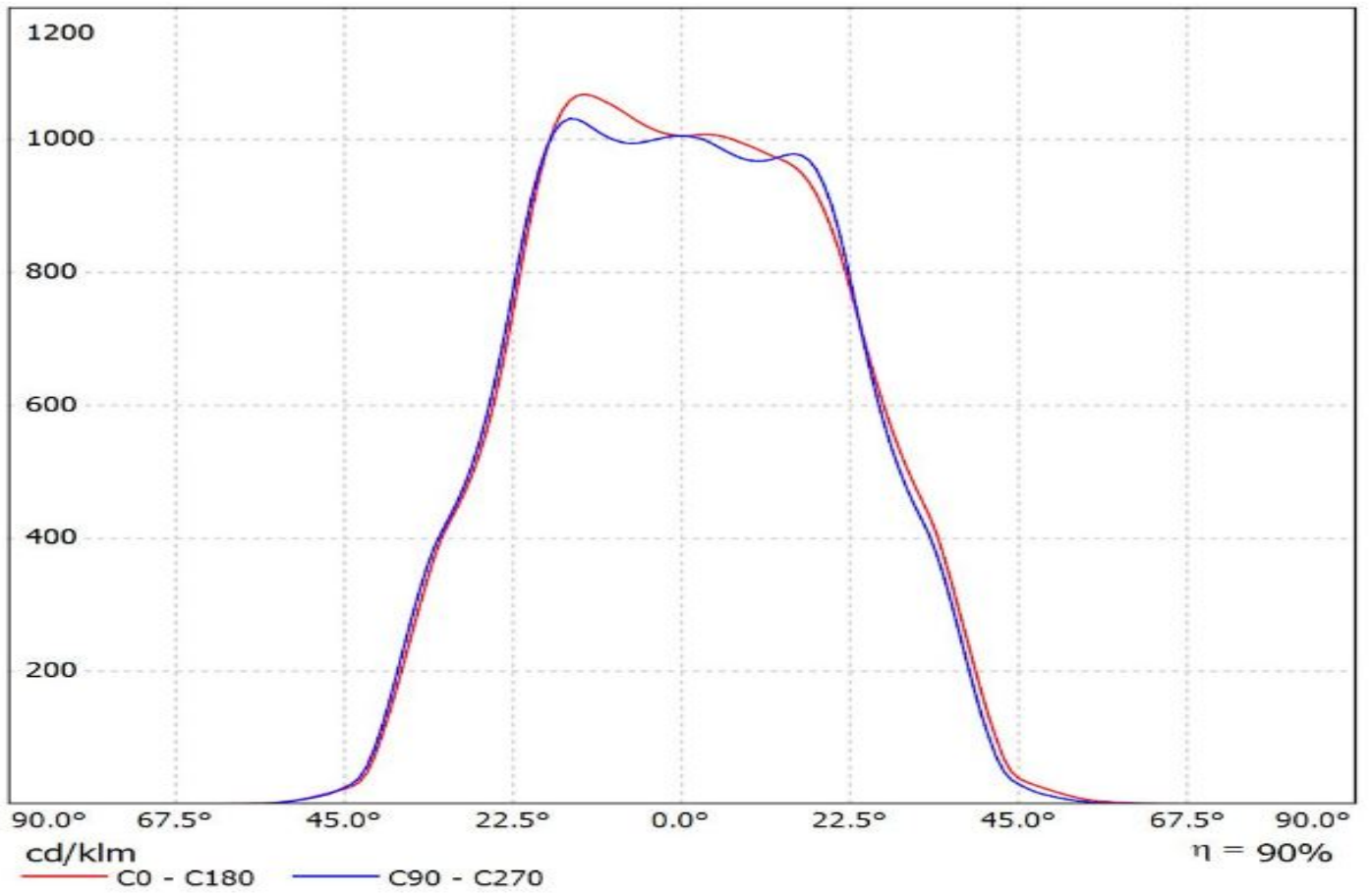

Luminaire: Ledil CN12702\_LENINA-W\_(CLU720)  
Lamps: 1 x CITIZEN\_CLU720\_(CLU720-1206B8-273M2)  
\_1312.67lm@250mA\_CCT=2700K\_P=8.35W\_I=0.25A

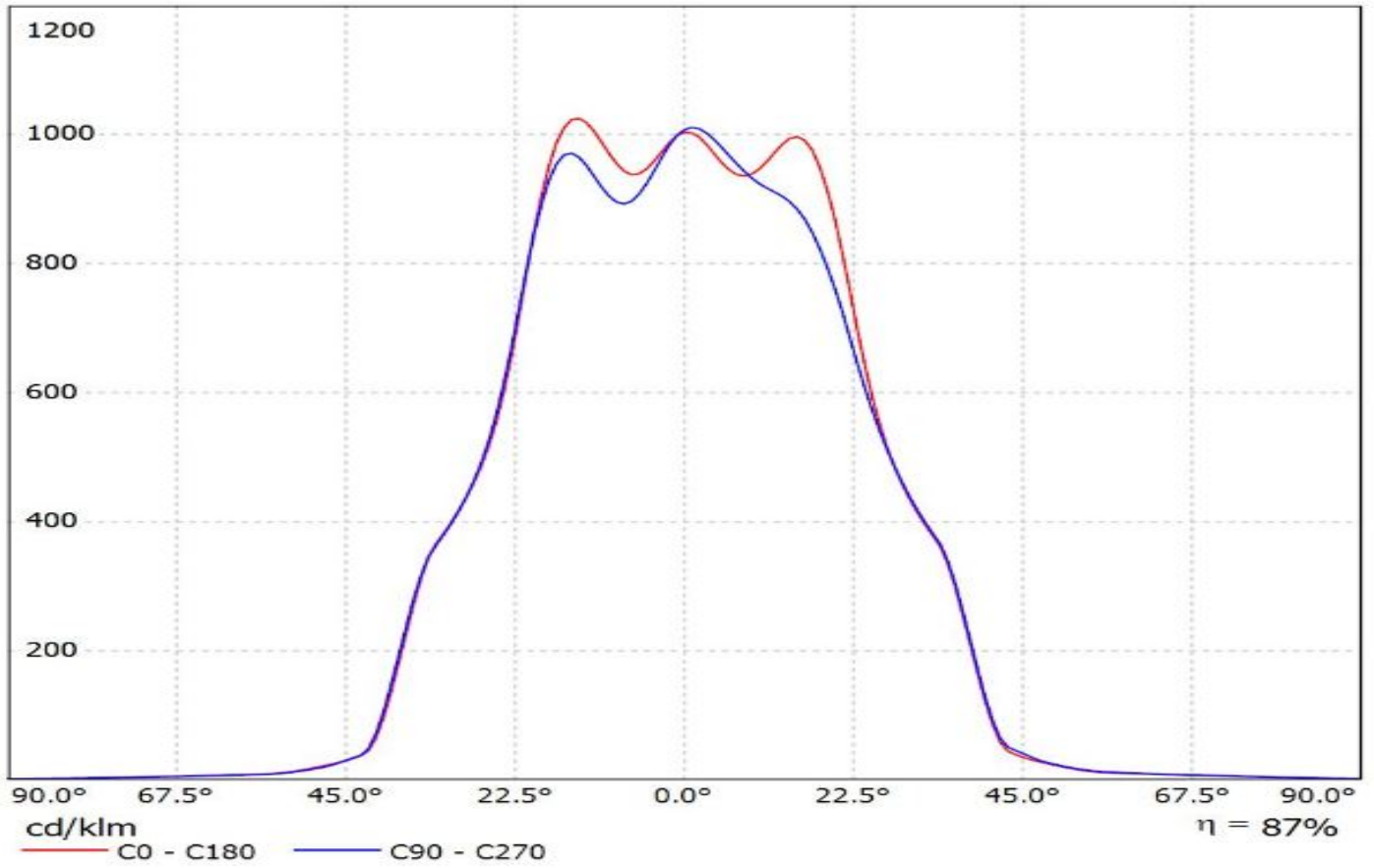

Luminaire: LEDil Oy CN12702\_LENINA-W\_(CXM-14)

Lamps: 1 x Luminus CXM-14 (1006.41lm @ 250mA) CCT=3100K P=8.5W I=250mA

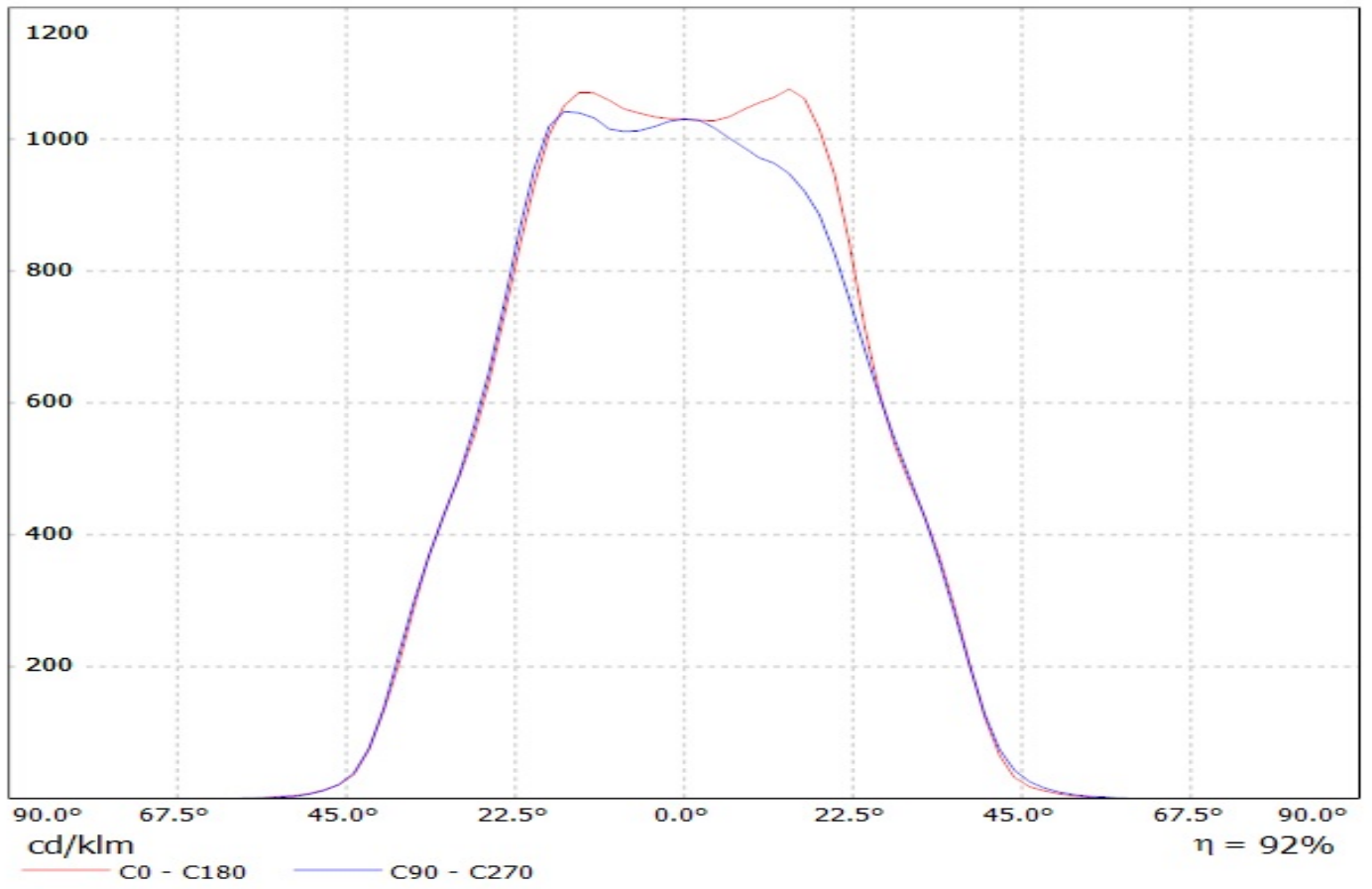

Luminaire: Ledil CN12702\_LENINA-W\_(COB-D\_LES\_14.5mm)

Lamps: 1 x Samsung\_COB-D\_Series\_LES\_14.5mm\_(LC026D)\_+C12691\_1263.5lm@250mA\_CCT=3000K\_P=8.1565W\_I=0.25A

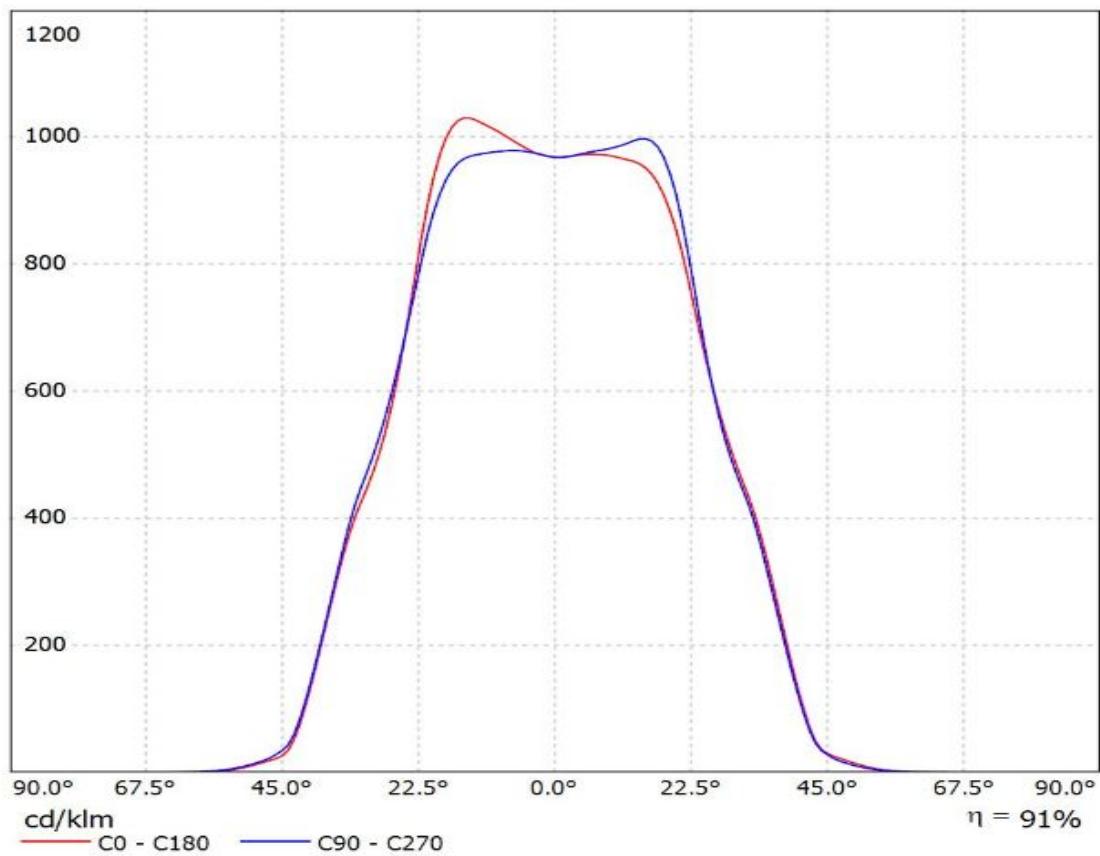

Luminaire: LEDiL Oy CN12702\_LENINA-W\_(ZC12) Eff.88.2%

Lamps: 1 x SEOUL\_ZC12\_(SDW82F1C)\_1209.83lm@250mA\_CCT=3000K\_P=8.64658W\_I=249.8mA

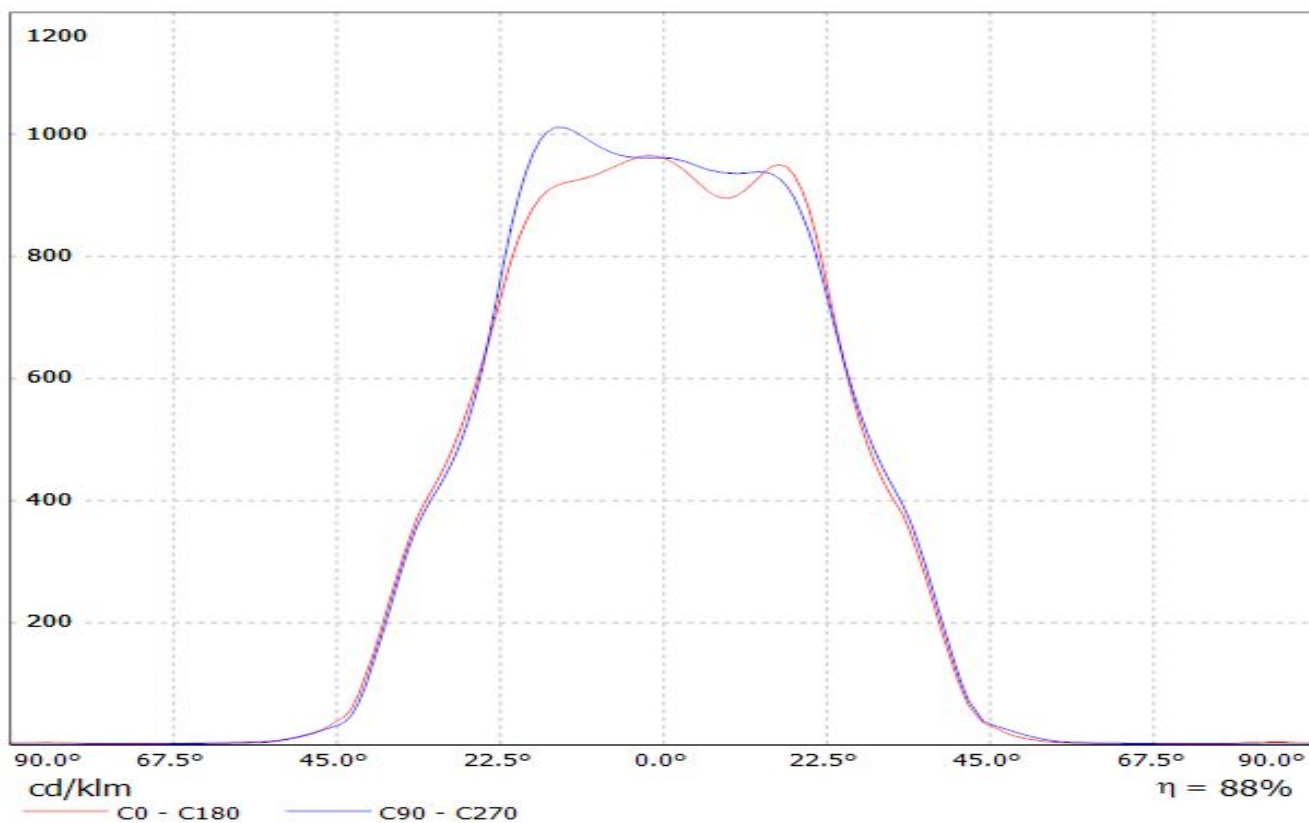



Luminaire: LEDiL Oy CN12702\_LENINA-W\_(SLE\_G3\_LES17) Eff.88.8%

Lamps: 1 x TRIDONIC\_STARK\_SLE\_G3\_LES17\_(STARK-SLE-PURE\_G3-17-2000-840-CLA)\_1011.62lm@250mA\_P=8.29243W\_I=249.9mA

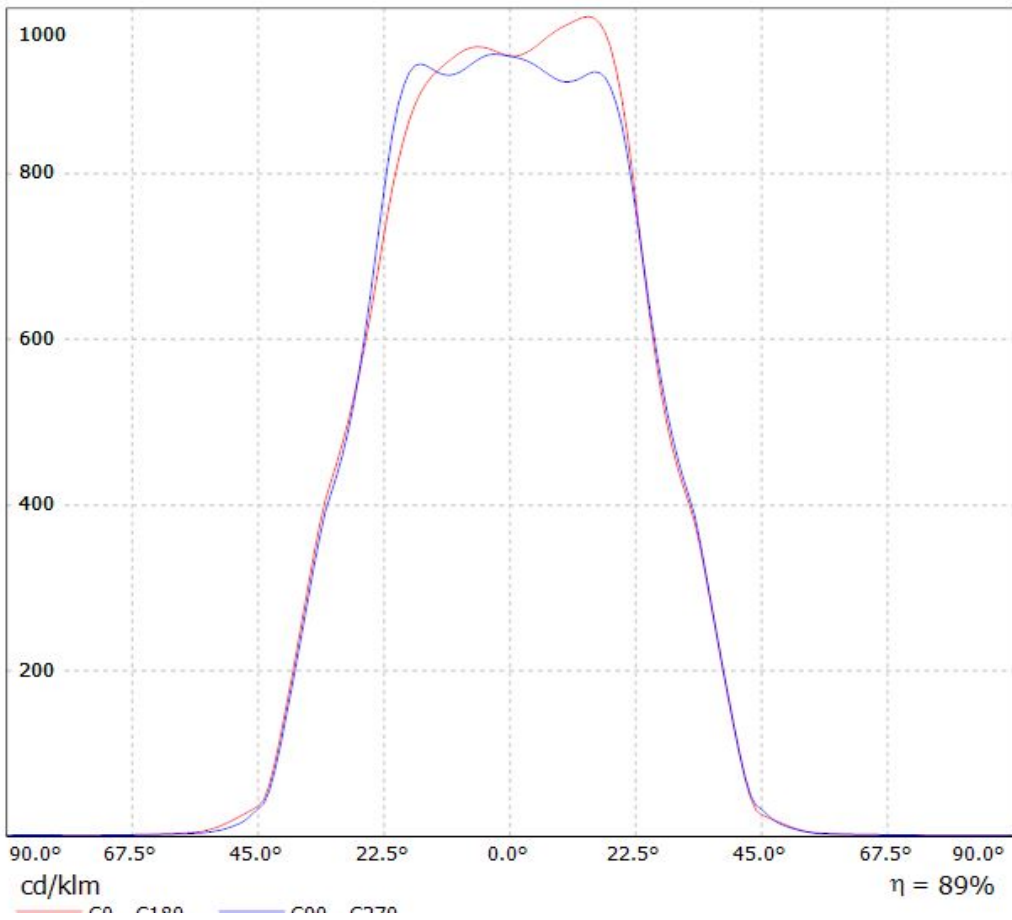

Luminaire: LEDiL Oy CN12702\_LENINA-W\_(SLE-G5\_LES-15)

Lamps: 1 x Tridonic\_SLE-G5\_LES-15\_1237.18lm@250mA\_P=8.6903W\_I=0.250A

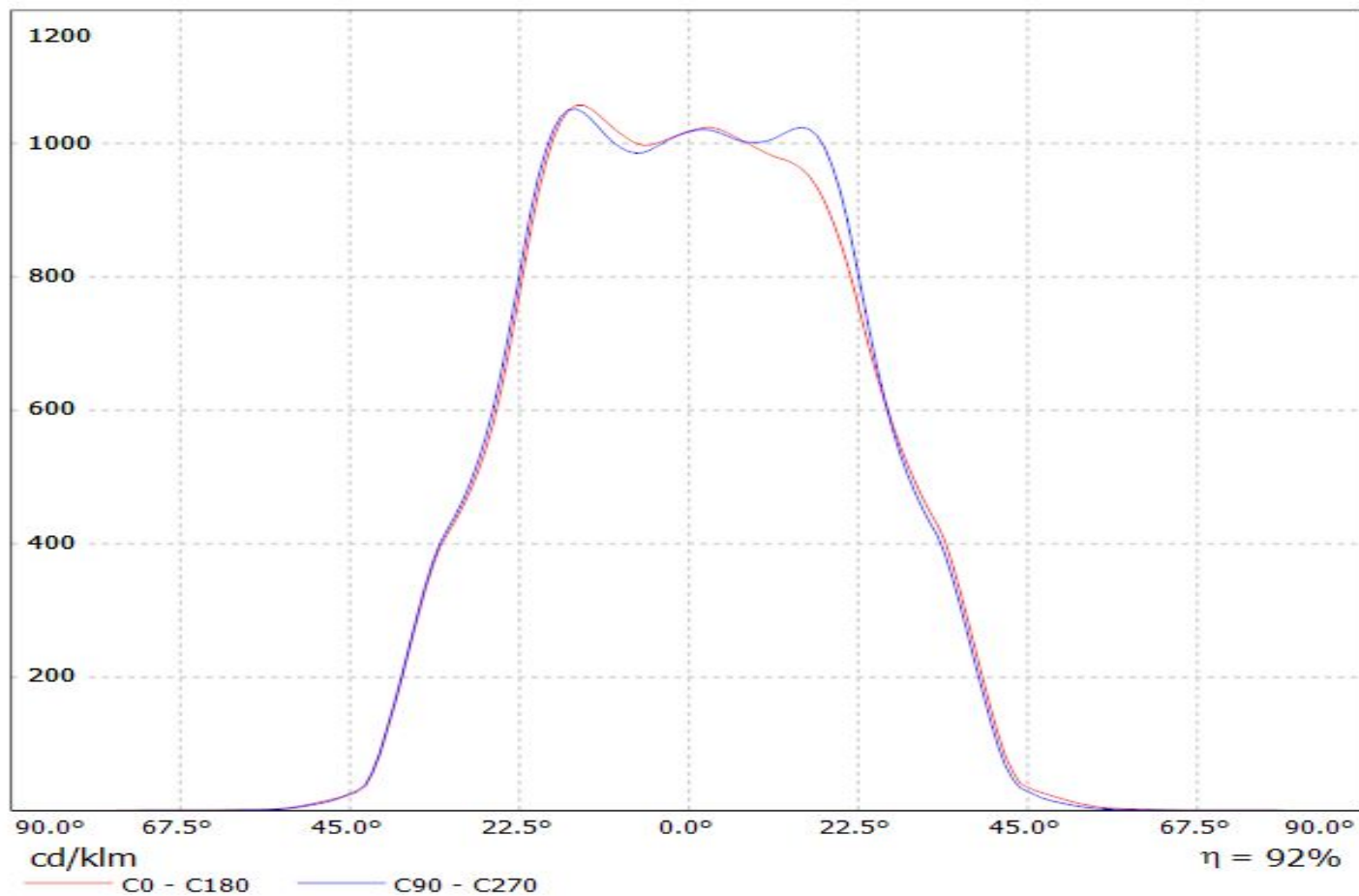

Luminaire: Ledil CN12702\_LENINA-W\_(CLU036)

Lamps: 1 x CLU036\_(-1208C1-303M2G2)\_1273.68lm@250mA\_P=8.24W\_I=0.25A

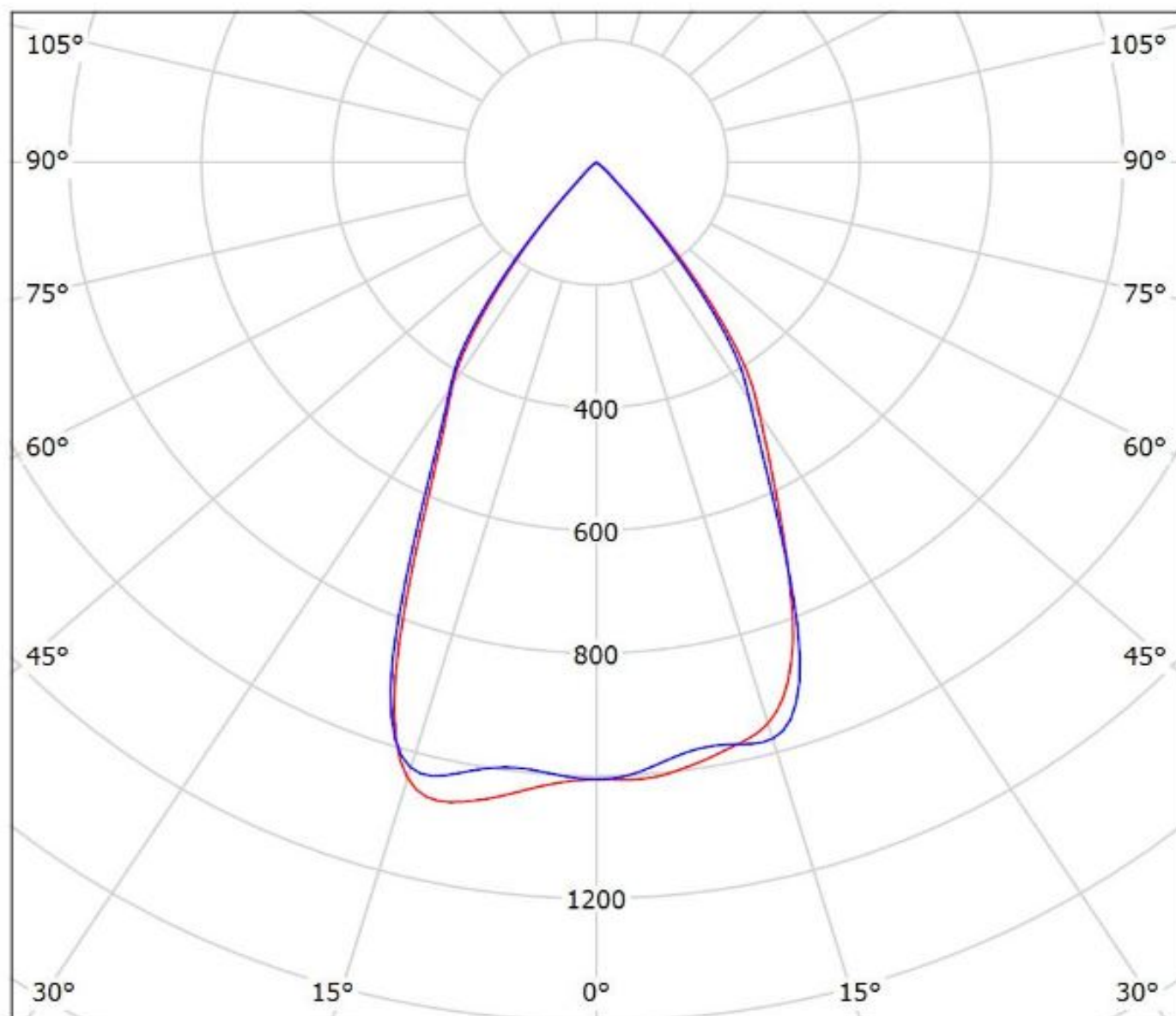

cd/klm

— C0 - C180

— C90 - C270

η = 90%

Luminaire: Ledil CN12702\_LENINA-W (CLU720)  
Lamps: 1 x CITIZEN\_CLU720 (CLU720-1206B8-273M2)  
\_1312.67lm@250mA\_CCT=2700K\_P=8.35W\_I=0.25A

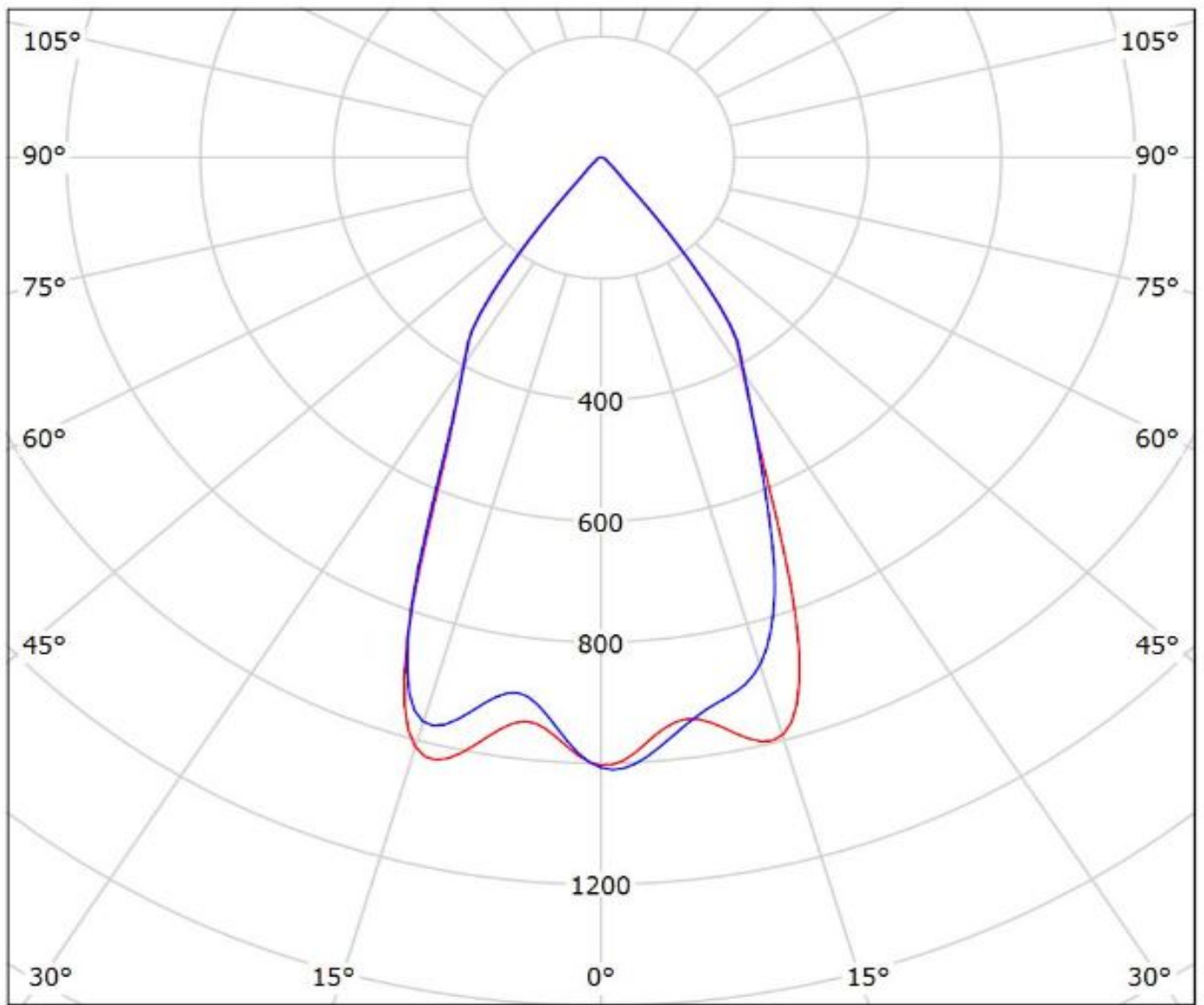

cd/klm

— C0 - C180 — C90 - C270

$\eta = 87\%$

Luminaire: LEDil Oy CN12702\_LENINA-W\_(CXM-14)

Lamps: 1 x Luminus CXM-14 (1006.41lm @ 250mA) CCT=3100K P=8.5W I=250mA

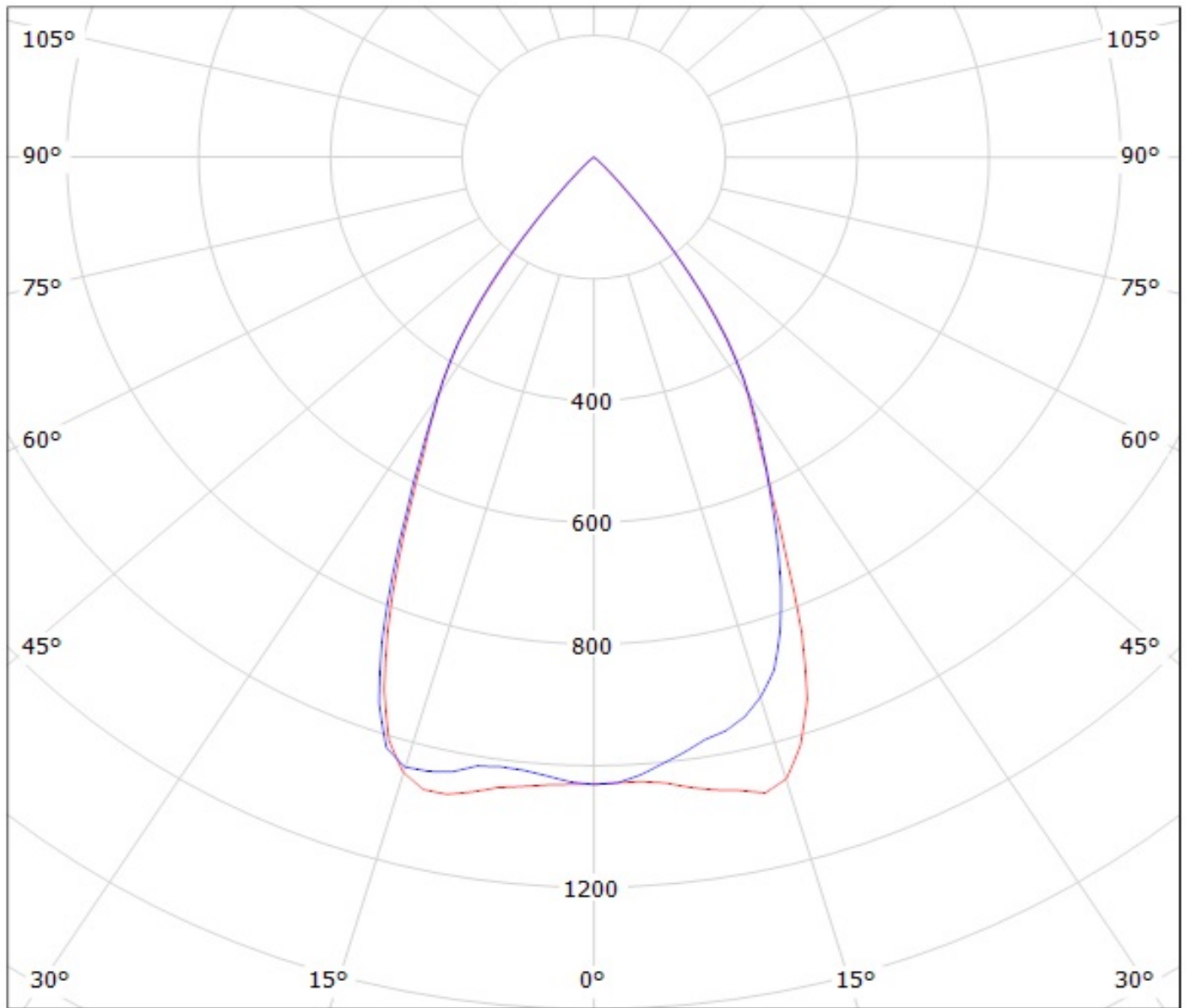

cd/klm

— C0 - C180    — C90 - C270

$\eta = 92\%$

Luminaire: Ledil CN12702\_LENINA-W\_(COB-D\_LES\_14.5mm)

Lamps: 1 x Samsung\_COB-D\_Series\_LES\_14.5mm\_(LC026D)\_+C12691\_1263.51lm@250mA\_CCT=3000K\_P=8.1565W\_I=0.25A

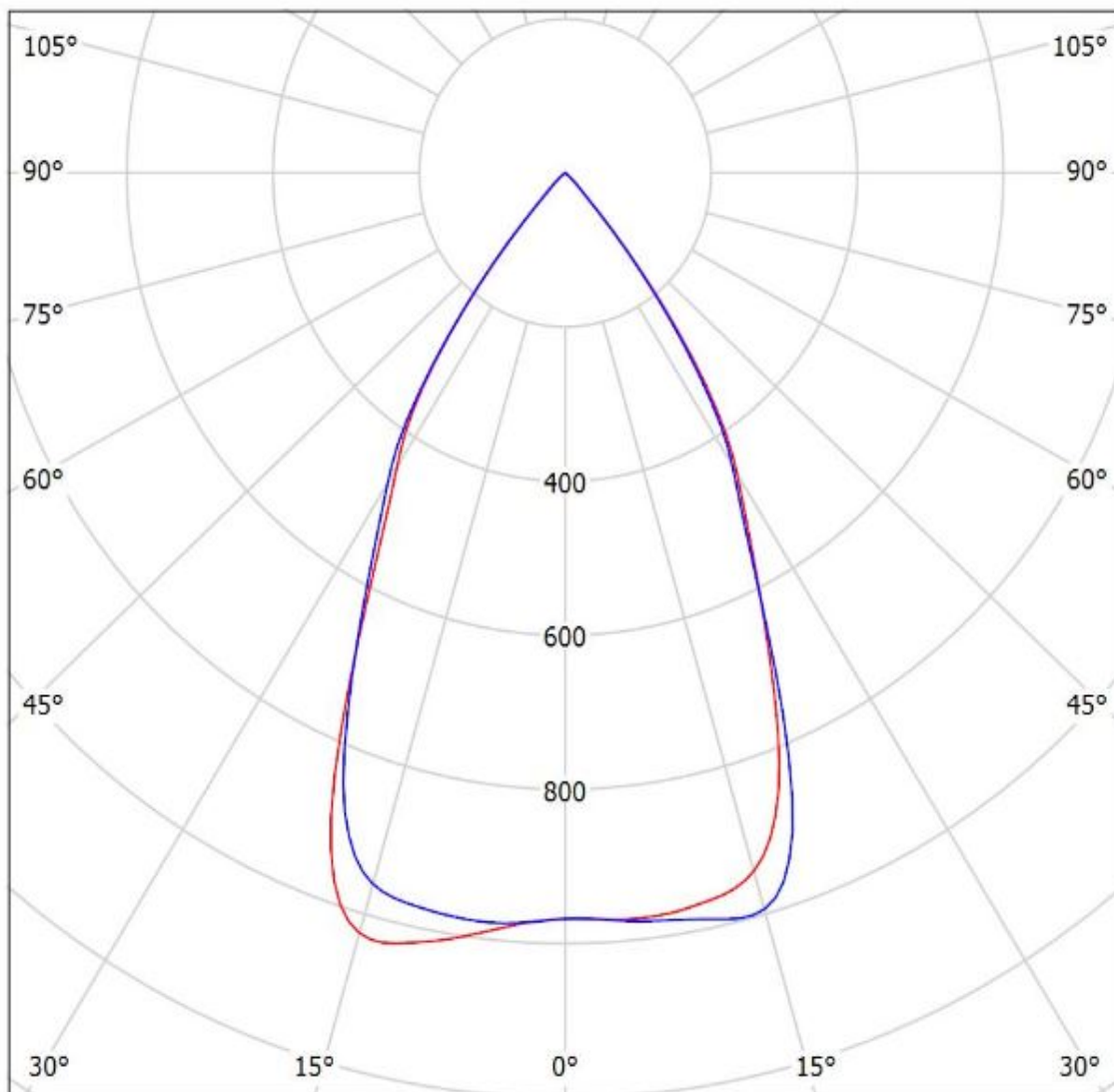

cd/klm

— C0 - C180 — C90 - C270

$\eta = 91\%$



Luminaire: LEDiL Oy CN12702\_LENINA-W\_(ZC12) Eff.88.2%

Lamps: 1 x SEOUL\_ZC12\_(SDW82F1C)\_1209.83lm@250mA\_CCT=3000K\_P=8.64658W\_I=249.8mA

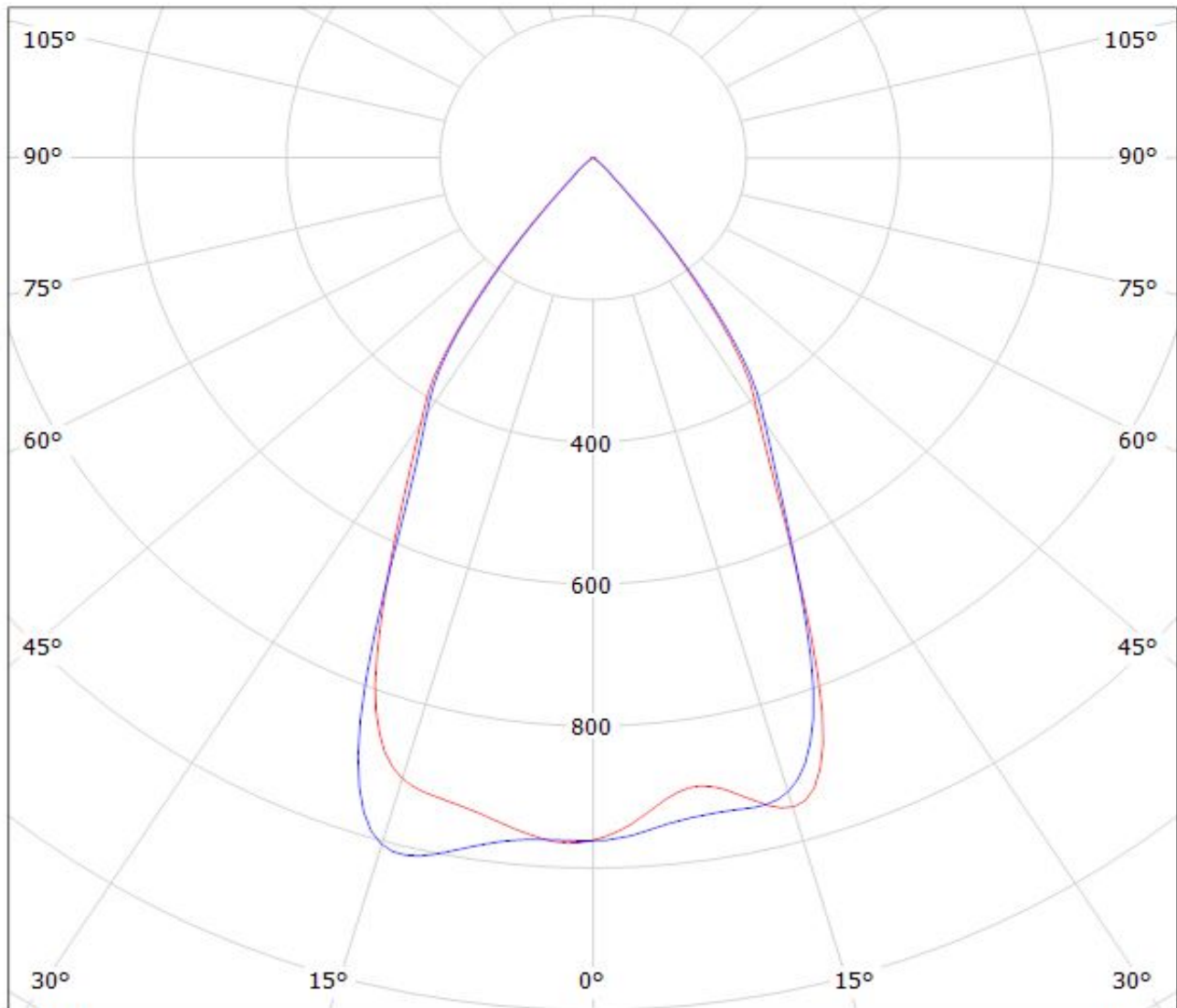

cd/klm

— C0 - C180

— C90 - C270

$\eta = 88\%$

Luminaire: LEDiL Oy CN12702\_LENINA-W\_(SLE\_G3\_LES17) Eff.88.8%

Lamps: 1 x TRIDONIC\_STARK\_SLE\_G3\_LES17\_(STARK-SLE-PURE\_G3-17-2000-840-CLA)\_1011.62lm@250mA\_P=8.29243W\_I=249.9mA

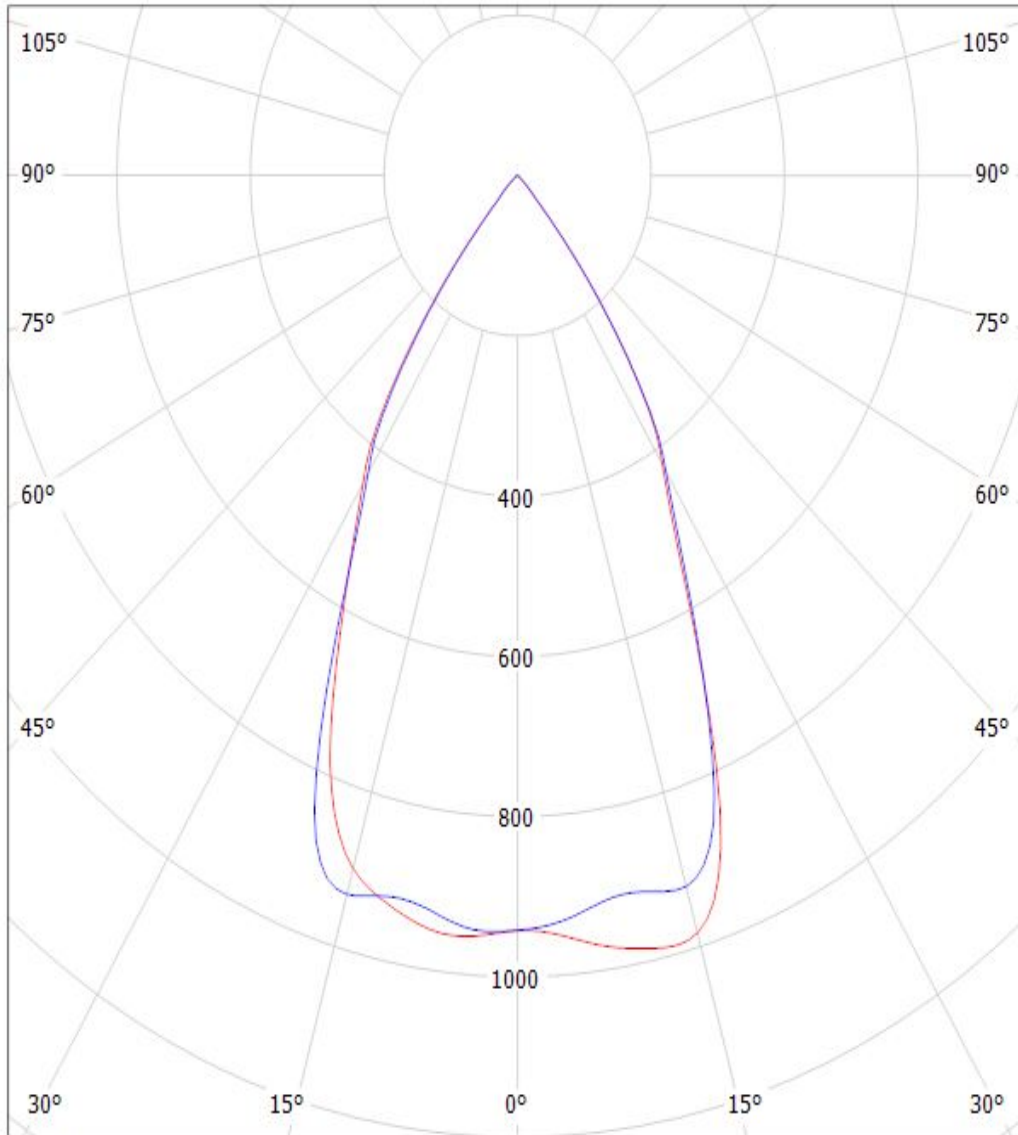

cd/klm

— C0 - C180    — C90 - C270

$\eta = 89\%$



Luminaire: LEDiL Oy CN12702\_LENINA-W\_(SLE-G5\_LES-15)

Lamps: 1 x Tridonic\_SLE-G5\_LES-15\_1237.18lm@250mA\_P=8.6903W\_I=0.250A

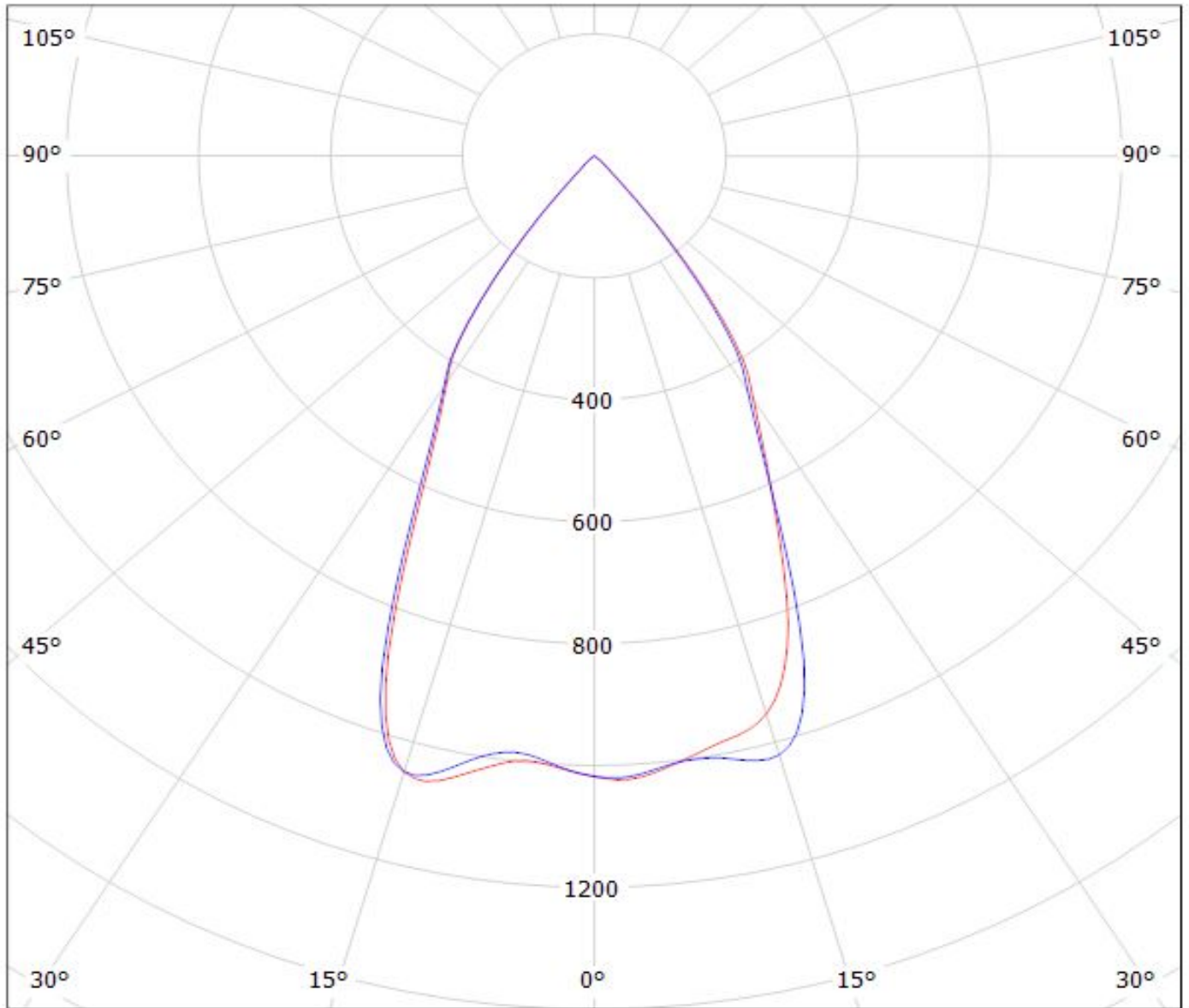

cd/klm

— C0 - C180

— C90 - C270

$\eta = 92\%$

**NOTE: The typical divergence will be changed by different color, chip size and chip position tolerance. The typical total divergence is the full angle measured where the luminous intensity is half of the peak value.**

### **GENERAL INFORMATION**

- Product series especially designed & optimized for series of LEDs.
- Special care taken to make light distribution as uniform as possible.

Note! Due to use of high power COB's with this product, special attention to proper thermal design is highly recommended. LEDiL has no liability for direct, indirect or consecutive damages arising from the LEDiL products being used outside of the recommended temperature range.