



W1910/W1911



W1910-M

Features:

- Small form factor monopole
- Antenna size W x H:
W1910/W1911(10.4 x 49.0mm)
W1910-M (12 x 50mm)
- Lead free materials
- RoHS Compliant Product
- Connector Type:
W1910/W1910-M SMA (male)
W1911 RP-SMA (male)

Applications:

- Penta band EU/US GSM/WCDMA
- Frequency range:
850 / 900 / 1800 / 1900/ 2100 MHz
- M2M Applications

All dimensions are in mm

Issue: 1715

In the effort to improve our products, we reserve the right to make changes judged to be necessary.

CONFIDENTIAL AND PROPRIETARY INFORMATION

This document contains confidential and proprietary information of Pulse Electronics, Inc. (Pulse) and is protected by copyright, trade secret and other state and federal laws. Its receipt or possession does not convey any rights to reproduce, disclose its contents, or to manufacture, use or sell anything it may describe. Reproduction, disclosure or use without specific written authorization of Pulse is strictly forbidden.

For more information:

Pulse Worldwide Headquarters
15255 Innovation Drive #100
San Diego, CA 92128
USA
Tel:1-858-674-8100

Pulse/Larsen Antennas
18110 SE 34th St Bldg 2 Suite 250
Vancouver, WA 98683
USA
Tel: 1-360-944-7551

Europe Headquarters
Pulse GmbH & Do, KG
Zeppelinstrasse 15
Herrenberg, Germany
Tel: 49 7032 7806 0

Pulse (Suzhou) Wireless Products Co, Inc.
99 Huo Ju Road(#29 Bldg,4th Phase
Suzhou New District
Jiangsu Province, Suzhou 215009 PR China
Tel: 86 512 6807 9998



Series: Stubby Antenna

Description: 3G Pentaband 824-2170MHz,
Straight

PART NUMBER: W1910/W1911/W1910-M

ELECTRICAL SPECIFICATIONS

Frequency	824-960MHz 1710-2170MHz
Nominal Impedance	50Ω
Return Loss	-4dB 824-960MHz -6dB 1710-2170MHz
Peak Gain	1dBi 824-960MHz 2dBi 1710-2170MHz
Efficiency	51%
Radiation Pattern	Omni
Polarization:	Linear
Power withstanding	5W

Issue: 1715

In the effort to improve our products, we reserve the right to make changes judged to be necessary.

CONFIDENTIAL AND PROPRIETARY INFORMATION

This document contains confidential and proprietary information of Pulse Electronics, Inc. (Pulse) and is protected by copyright, trade secret and other state and federal laws. Its receipt or possession does not convey any rights to reproduce, disclose its contents, or to manufacture, use or sell anything it may describe. Reproduction, disclosure or use without specific written authorization of Pulse is strictly forbidden.

For more information:

Pulse Worldwide Headquarters
15255 Innovation Drive #100
San Diego, CA 92128
USA
Tel:1-858-674-8100

Pulse/Larsen Antennas
18110 SE 34th St Bldg 2 Suite 250
Vancouver, WA 98683
USA
Tel: 1-360-944-7551

Europe Headquarters
Pulse GmbH & Do, KG
Zeppelinstrasse 15
Herrenberg, Germany
Tel: 49 7032 7806 0

Pulse (Suzhou) Wireless Products Co, Inc.
99 Huo Ju Road(#29 Bldg,4th Phase
Suzhou New District
Jiangsu Province, Suzhou 215009 PR China
Tel: 86 512 6807 9998



Description: 3G Pentaband 824-2170MHz,
Straight

Series: Stubby Antenna

PART NUMBER: W1910/W1911/W1910-M

MECHANICAL SPECIFICATIONS

Weight	W1910/W1911:7.5g W1910-M :7.8g
Antenna Color / Material	Black
Connector type	W1910/W1910-M SMA(Male) W1911 RP-SMA(Male)

ENVIRONMENTAL SPECIFICATIONS

Operating Temperature	-30/+75 ° C
Storage Temperature	-30/+75 ° C
Ingress Protection	IP65(W1910-M)
Wind-loading	100km/h
RoHS Compliant	Yes

Series: Stubby Antenna

Description: 3G Pentaband 824-2170MHz,
Straight

PART NUMBER: W1910/W1911/W1910-M

MECHANICAL DRAWING

W1910/W1911

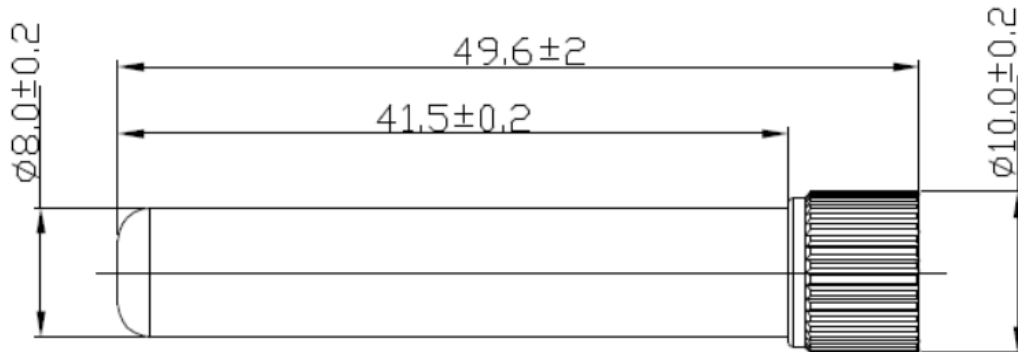

W1910-M

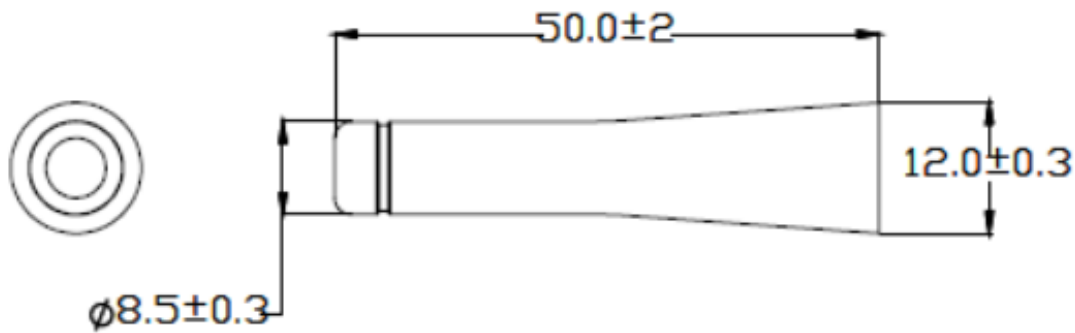

Issue: 1715

In the effort to improve our products, we reserve the right to make changes judged to be necessary.

CONFIDENTIAL AND PROPRIETARY INFORMATION

This document contains confidential and proprietary information of Pulse Electronics, Inc. (Pulse) and is protected by copyright, trade secret and other state and federal laws. Its receipt or possession does not convey any rights to reproduce, disclose its contents, or to manufacture, use or sell anything it may describe. Reproduction, disclosure or use without specific written authorization of Pulse is strictly forbidden.

CHARTS

Return Loss

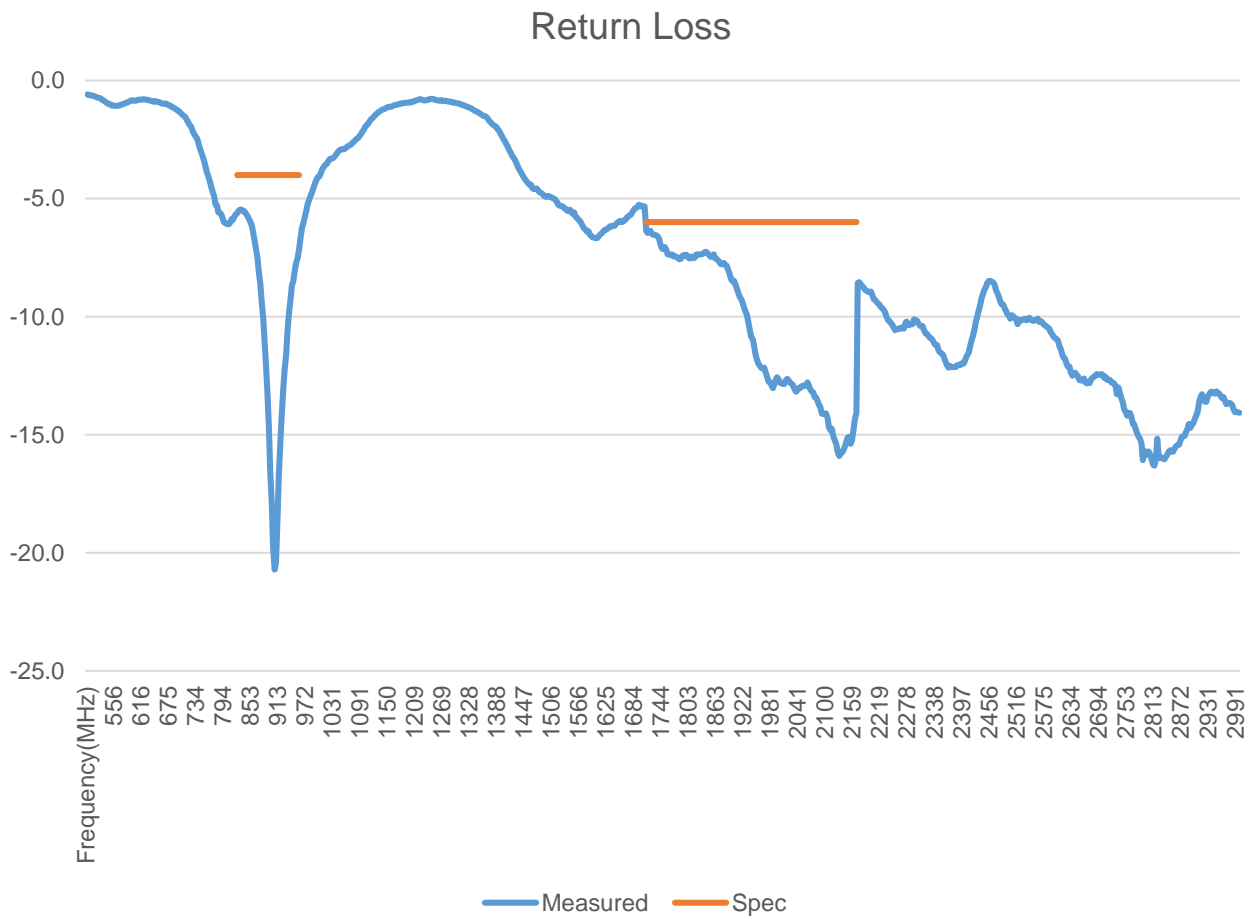

Issue: 1715

In the effort to improve our products, we reserve the right to make changes judged to be necessary.

CONFIDENTIAL AND PROPRIETARY INFORMATION

This document contains confidential and proprietary information of Pulse Electronics, Inc. (Pulse) and is protected by copyright, trade secret and other state and federal laws. Its receipt or possession does not convey any rights to reproduce, disclose its contents, or to manufacture, use or sell anything it may describe. Reproduction, disclosure or use without specific written authorization of Pulse is strictly forbidden.

Description: 3G Pentaband 824-2170MHz,
Straight

Series: Stubby Antenna

PART NUMBER: W1910/W1911/W1910-M

CHARTS

Efficiency(%)

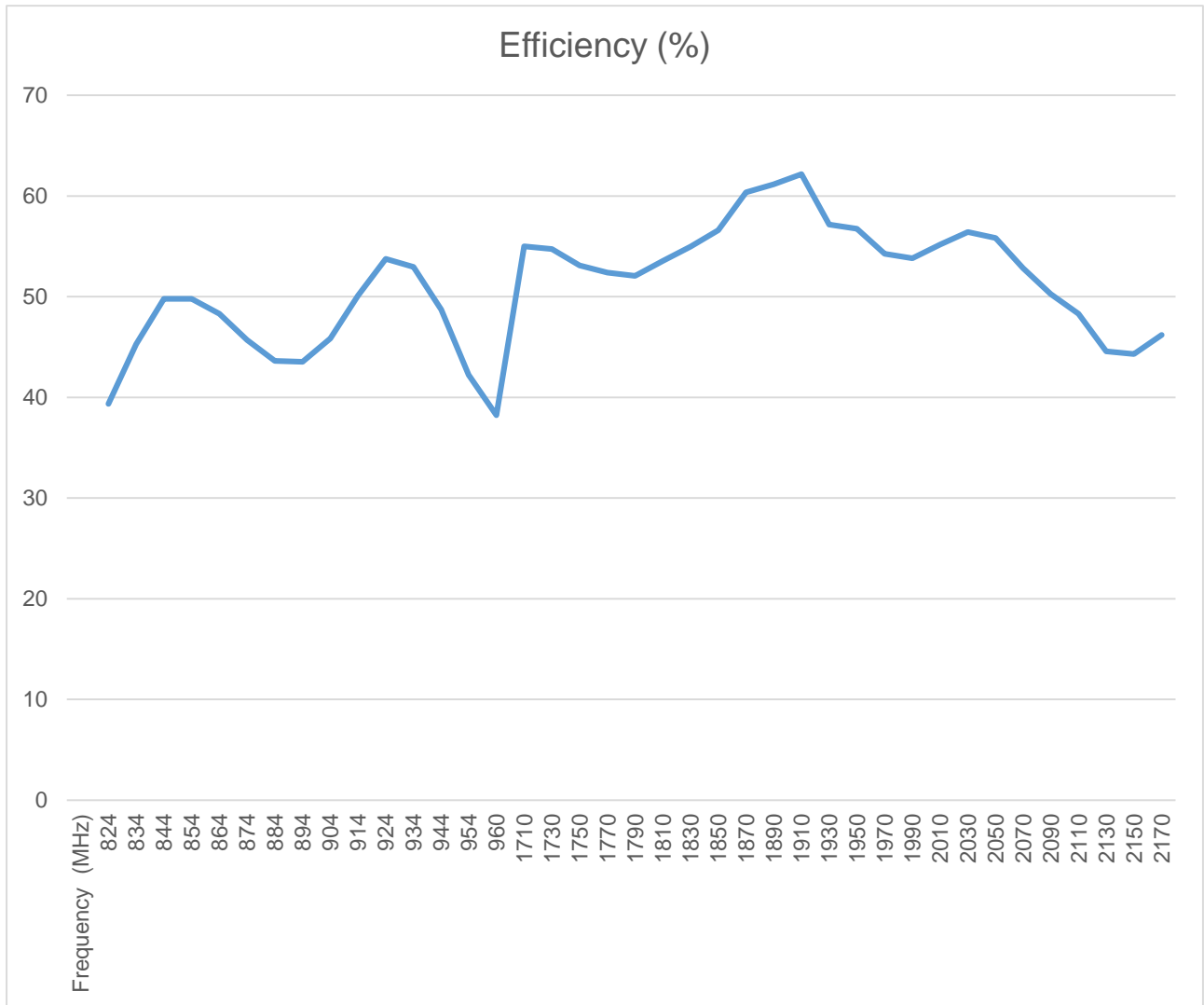

Issue: 1715

In the effort to improve our products, we reserve the right to make changes judged to be necessary.

CONFIDENTIAL AND PROPRIETARY INFORMATION

This document contains confidential and proprietary information of Pulse Electronics, Inc. (Pulse) and is protected by copyright, trade secret and other state and federal laws. Its receipt or possession does not convey any rights to reproduce, disclose its contents, or to manufacture, use or sell anything it may describe. Reproduction, disclosure or use without specific written authorization of Pulse is strictly forbidden.



Description: 3G Pentaband 824-2170MHz,
Straight

Series: Stubby Antenna

PART NUMBER: W1910/W1911/W1910-M

CHARTS

Peak Gain (dBi)

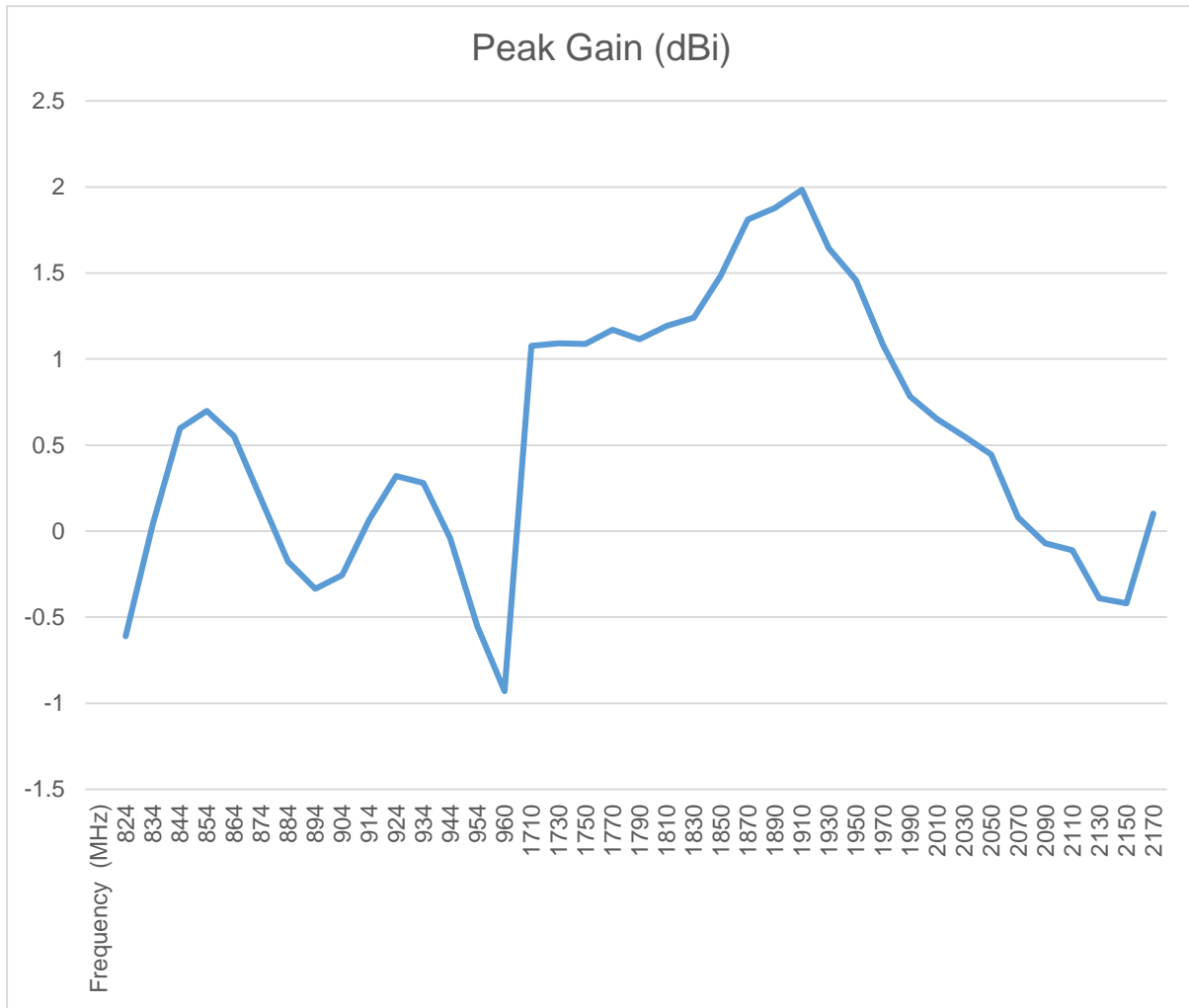

Issue: 1715

In the effort to improve our products, we reserve the right to make changes judged to be necessary.

CONFIDENTIAL AND PROPRIETARY INFORMATION

This document contains confidential and proprietary information of Pulse Electronics, Inc. (Pulse) and is protected by copyright, trade secret and other state and federal laws. Its receipt or possession does not convey any rights to reproduce, disclose its contents, or to manufacture, use or sell anything it may describe. Reproduction, disclosure or use without specific written authorization of Pulse is strictly forbidden.

Description: 3G Pentaband 824-2170MHz,
Straight

Series: Stubby Antenna

PART NUMBER: W1910/W1911/W1910-M

CHARTS

Free Space Radiation Pattern

Elevation Plane

Horizontal Plane

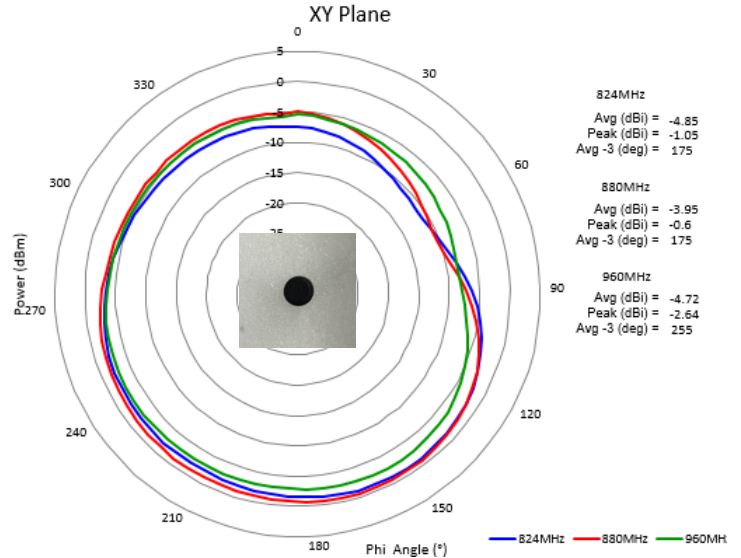
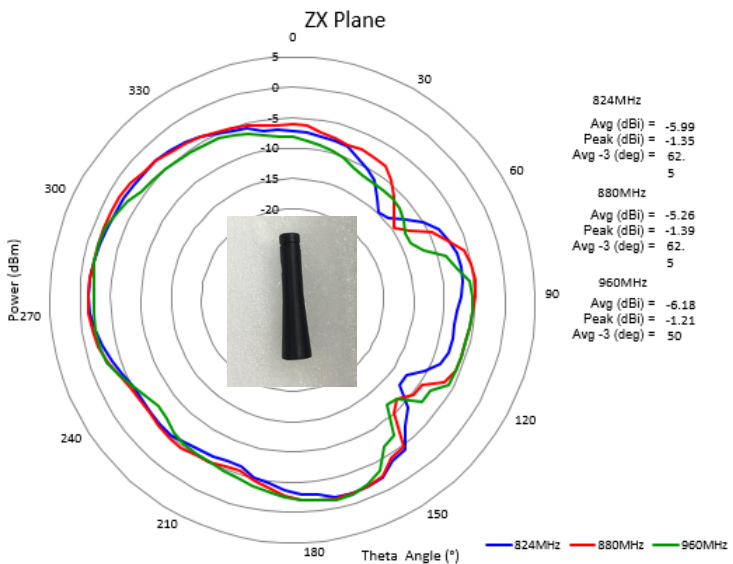

Issue: 1715

In the effort to improve our products, we reserve the right to make changes judged to be necessary.

CONFIDENTIAL AND PROPRIETARY INFORMATION

This document contains confidential and proprietary information of Pulse Electronics, Inc. (Pulse) and is protected by copyright, trade secret and other state and federal laws. Its receipt or possession does not convey any rights to reproduce, disclose its contents, or to manufacture, use or sell anything it may describe. Reproduction, disclosure or use without specific written authorization of Pulse is strictly forbidden.

Description: 3G Pentaband 824-2170MHz,
Straight

Series: Stubby Antenna

PART NUMBER: W1910/W1911/W1910-M

CHARTS

Free Space Radiation Pattern

Elevation Plane

Horizontal Plane

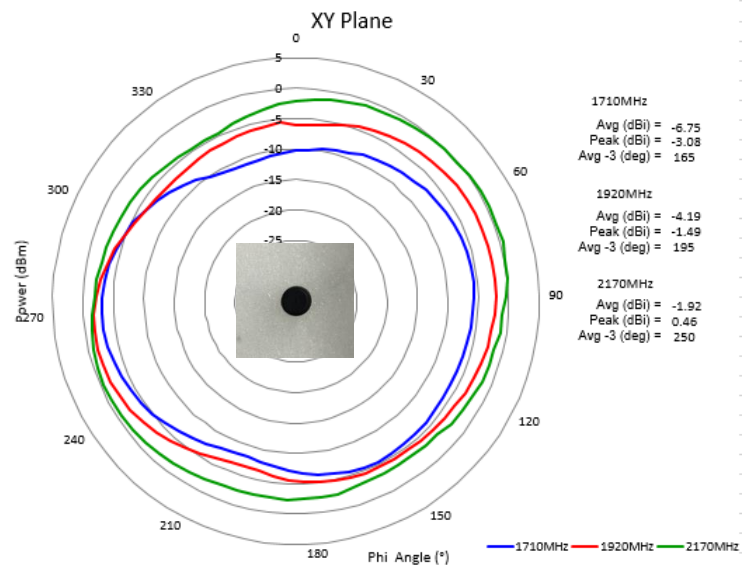
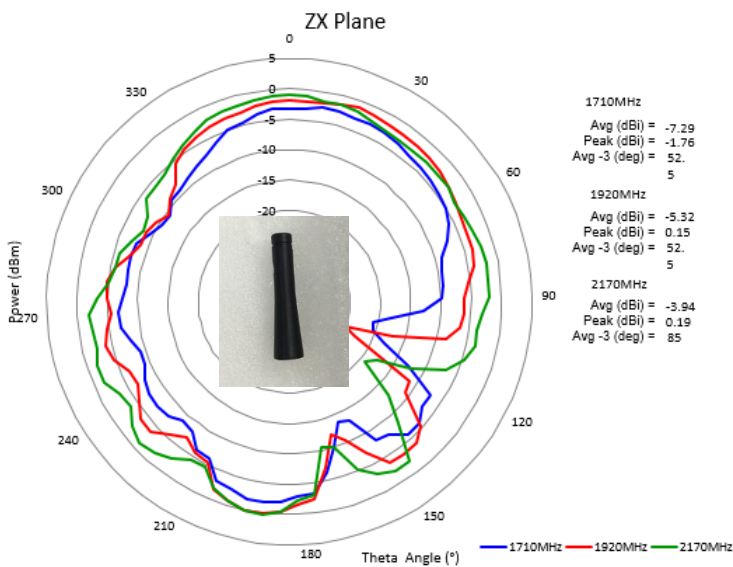

Issue: 1715

In the effort to improve our products, we reserve the right to make changes judged to be necessary.

CONFIDENTIAL AND PROPRIETARY INFORMATION

This document contains confidential and proprietary information of Pulse Electronics, Inc. (Pulse) and is protected by copyright, trade secret and other state and federal laws. Its receipt or possession does not convey any rights to reproduce, disclose its contents, or to manufacture, use or sell anything it may describe. Reproduction, disclosure or use without specific written authorization of Pulse is strictly forbidden.

Series: Stubby Antenna

Description: 3G Pentaband 824-2170MHz,
Straight

PART NUMBER: W1910/W1911/W1910-M

PACKAGING

1pcs antenna per PE bag

24pcs PE bags per tray

14pcs trays per package box(2 pcs empty tray)

288pcs antenna per package

Package box: 460mm*235mm*140mm