

PRODUCT NUMBER SEE SHEET 2

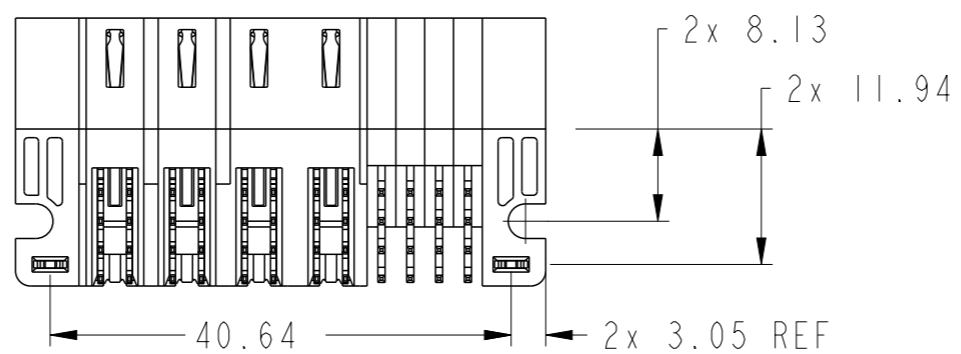
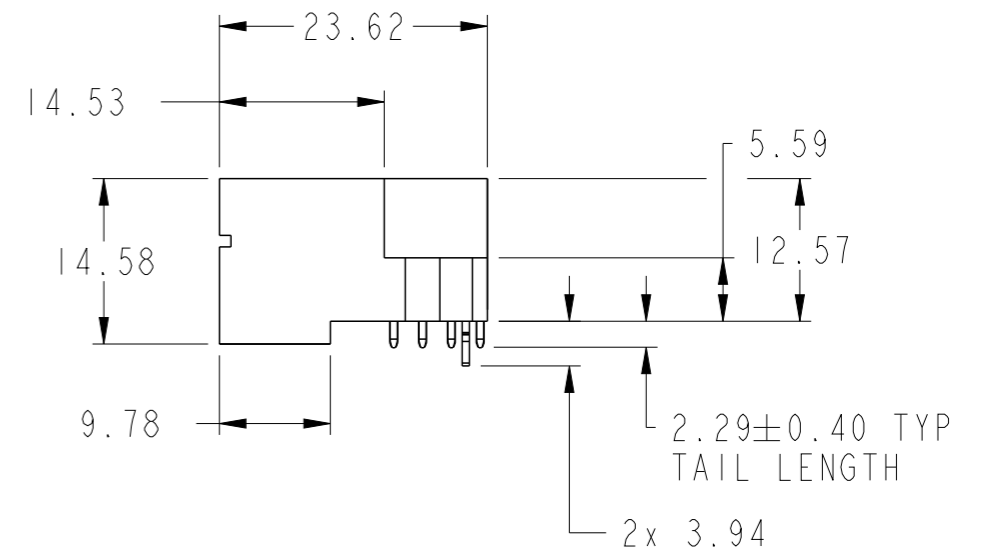
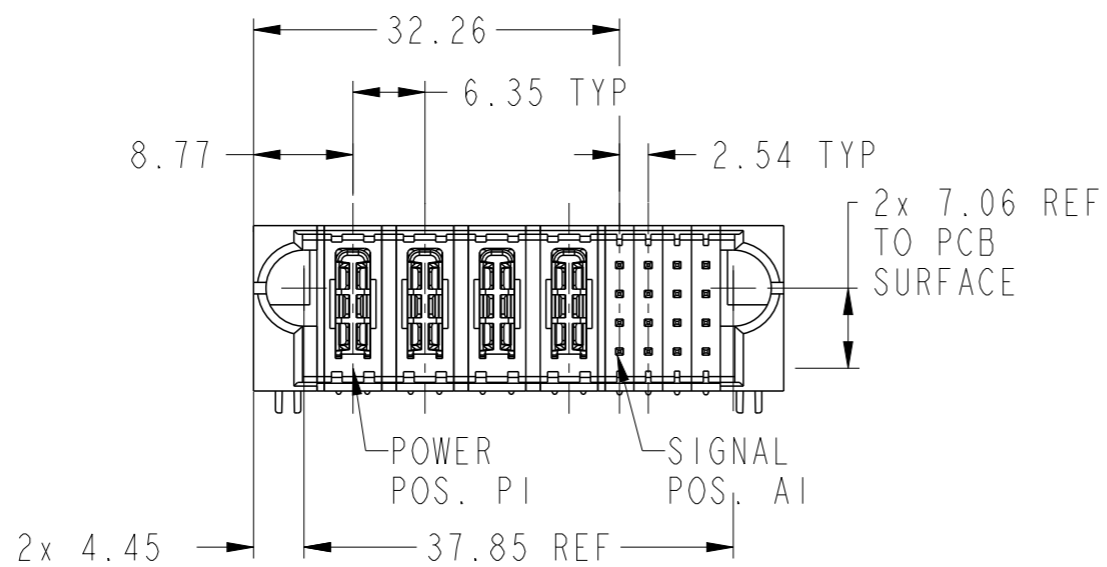
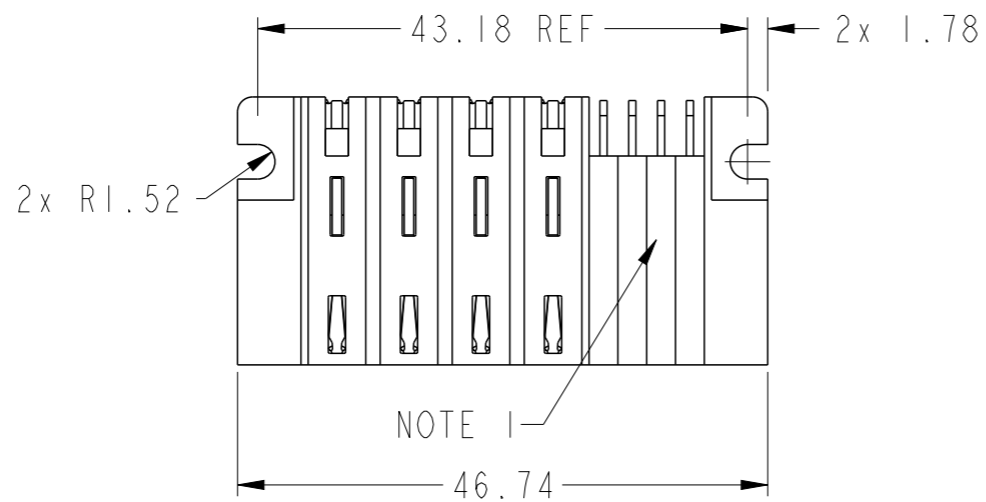

Copyright FCI.

spec ref	*	dr	Rainbow Zhan	2014/11/30	projection	MM	size	A3	scale	3:2	
tolerance std	ASME Y14.5	eng	Rainbow Zhan	2014/12/26			ecn no	-	rel level	Released	
TOLERANCES UNLESS OTHERWISE SPECIFIED		chr	Li-He He	2014/12/26							product family
surface	<input checked="" type="checkbox"/> linear <input type="checkbox"/> angular	appr	Pei-Ming Zheng	2014/12/26			title 4HP + 16S RA STB HEADER	dwg no 10106124-4004002	rev A	cat. no. Product - Customer Drw	sheet 1 of 3

PRODUCT NO.	ROWS	HIGH POWER SIGNAL											
		E1	P1	P2	P3	P4	1	2	3	4	E2		
10106124-4004002LF	DCBA	HA	H3	H3	H3	H3	V	V	V	V	V	V	HA
							Q	Q	Q	Q	Q	Q	
							P	P	P	P	P	P	
							N	N	N	N	N	N	

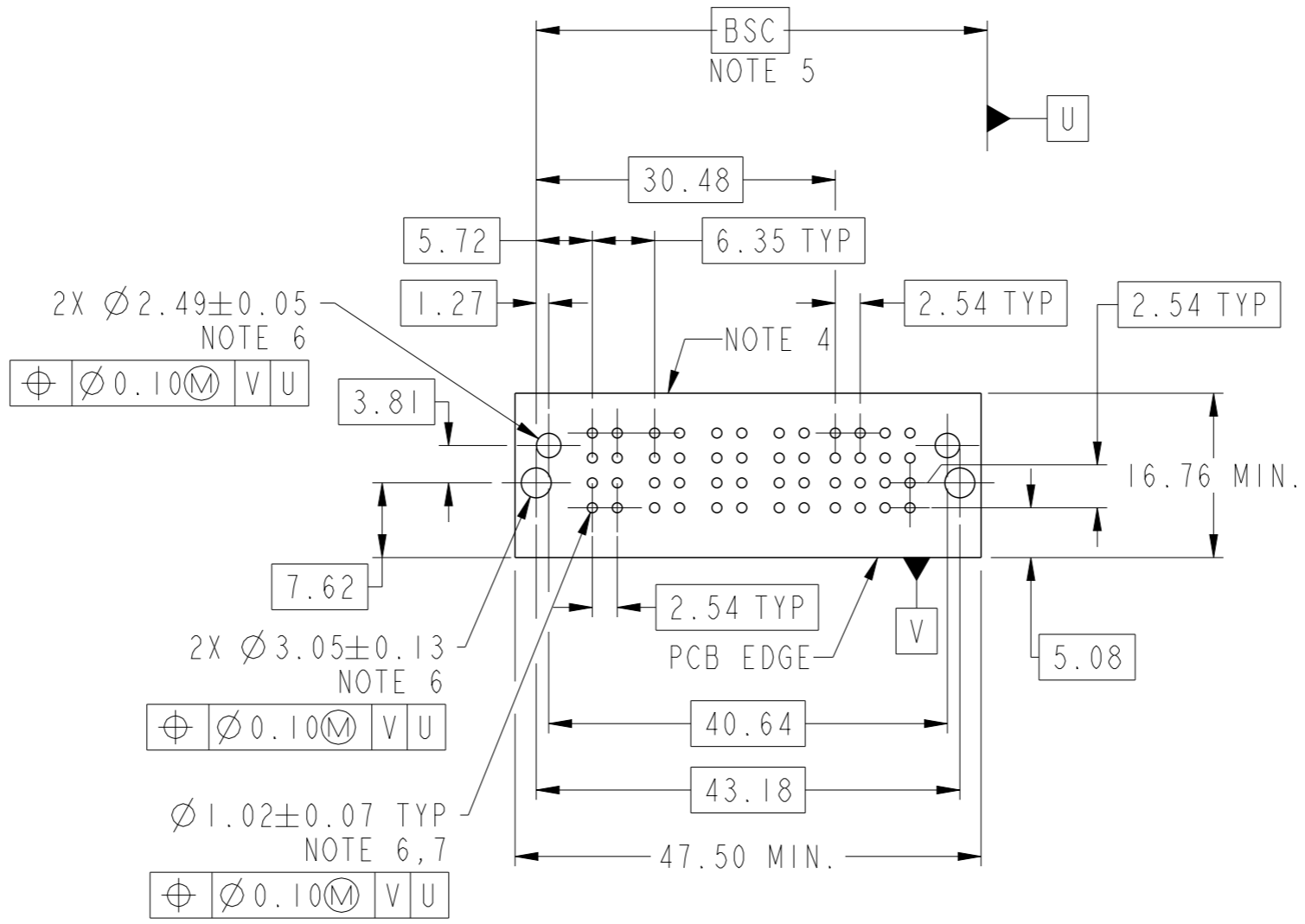

CODE	DESCRIPTION
A	MLBF SIGNAL CONTACT, ROW A (2.34)
H3	STD HIGH POWER CONTACT (2.29)
HA	METAL HOLD DOWN
N	STD SIGNAL CONTACT, ROW A (2.34)
P	STD SIGNAL CONTACT, ROW B (2.34)
Q	STD SIGNAL CONTACT, ROW C (2.34)
V	STD SIGNAL CONTACT, ROW D (2.34)

dr	Rainbow Zhan	2014/11/30	projection	MM	size	A3	scale	3:2
eng	Rainbow Zhan	2014/12/26			ecn no			
chr	Li-He He	2014/12/26			-			
appr	Pei-Ming Zheng	2014/12/26	product family	PwrBlade+	rel level	Released		
			title		4HP + 16S		dwg no	
www.fci.com			RA STB HEADER		10106124-4004002		rev	
cat. no.			Product - Customer Drw		sheet 2 of 3		A	

Copyright FCI.





NOTES:

- 1) "FCI", PART NUMBER AND DATE CODE TO BE MARKED ON THIS SURFACE.  
THE MARK CAN BE OMITTED IF THERE IS NOT ENOUGH SPACE ON THIS SURFACE.
- 2) MATERIALS:  
-HOUSING - GLASS FILLED WITH HIGH TEMP THERMOPLASTIC, UL94V-0.  
-SIGNAL CONTACT - COPPER ALLOY.  
-POWER CONTACT - HIGH CONDUCTIVITY COPPER ALLOY.
- 3) PLATING SPECIFICATION REFER TO FCI 10116351
- 4) DENOTES CONNECTOR KEEP OUT ZONE.
- 5) DATUM AND BASIC DIMENSIONS WERE ESTABLISHED BY CUSTOMER.
- 6) ALL HOLE DIAMETERS ARE FINISHED HOLE SIZES.
- 7)  $1.15 \pm 0.025$ MM DRILLED HOLE PLATED WITH 0.00762MM MIN Sn  
OVER 0.0254-0.0762MM Cu PLATING TO ACHIEVE A  $1.02 \pm 0.07$ MM HOLE.
- 8) PRODUCT SPECIFICATION REFER TO FCI GS-12-658.  
APPLICATION SPECIFICATION REFER TO FCI GS-20-141.  
PRODUCT PACKAGED IN TRAYS, REFER TO FCI GS-14-1502.

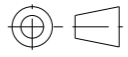
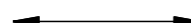

Copyright FCI.

dr	Rainbow Zhan	2014/11/30	projection 	MM 	size	A3	scale	3:2
eng	Rainbow Zhan	2014/12/26			ecn no	-		
chr	Li-He He	2014/12/26			rel level	Released		
appr	Pei-Ming Zheng	2014/12/26	product family	PwrBlade+				
		title 4HP + 16S RA STB HEADER		dwg no 10106124-4004002	rev A			
<a href="http://www.fci.com">www.fci.com</a>		cat. no.	Product - Customer Drw		sheet 3 of 3			