

# MAX17502E Evaluation Kit

## Evaluate: MAX17502E in TDFN Package

### General Description

The MAX17502E evaluation kit (EV kit) provides a proven design to evaluate the MAX17502E high-efficiency, high-voltage, synchronous step-down DC-DC converter. The EV kit uses this device to generate a fixed 3.3V, at load currents up to 1A, from a 4.5V to 60V input supply. The EV kit features a forced-PWM control scheme that provides constant switching-frequency operation at all load and line conditions.

### Features

- ◆ Operates from a 4.5V to 60V Input Supply
- ◆ 3.3V Fixed Output Voltage
- ◆ 1A Output Current
- ◆ 600kHz Switching Frequency
- ◆ Enable/UVLO Input
- ◆ Resistor-Programmable UVLO Threshold
- ◆ Open-Drain  $\overline{\text{RESET}}$  Output
- ◆ Overcurrent and Overtemperature Protection
- ◆ Proven PCB Layout
- ◆ Fully Assembled and Tested

[Ordering Information](#) appears at end of data sheet.

### Component List

DESIGNATION	QTY	DESCRIPTION
C1	1	2.2 $\mu\text{F}$ $\pm 10\%$ , 100V X7R ceramic capacitor (1210) Murata GRM32ER72A225K
C2	1	1 $\mu\text{F}$ $\pm 10\%$ , 6.3V X7R ceramic capacitor (0603) Murata GRM188R70J105K
C3	1	3300pF $\pm 10\%$ , 50V X7R ceramic capacitor (0402) Murata GRM155R71H332K
C4	1	22 $\mu\text{F}$ $\pm 10\%$ , 10V X7R ceramic capacitor (1210) Murata GRM32ER71A226K
C7	1	33 $\mu\text{F}$ , 80V aluminum electrolytic (D = 8mm) Panasonic EEEFK1K330P

DESIGNATION	QTY	DESCRIPTION
JU1	1	3-pin header
L1	1	15 $\mu\text{H}$ , 2A inductor (6mm x 6mm x 3.5mm) Coilcraft LPS6235-153ML
R1	1	3.32M $\Omega$ $\pm 1\%$ resistor (0402)
R2	1	866k $\Omega$ $\pm 1\%$ resistor (0402)
R4	1	100 $\Omega$ resistor (0402)
R6	1	10k $\Omega$ $\pm 1\%$ resistor (0402)
TP1, TP2	0	Not installed, test points
U1	1	Buck converter (10 TDFN-EP*) Maxim MAX17502EATB+
—	1	Shunt
—	1	PCB: MAX17502ET EVALUATION KIT

\*EP = Exposed pad.

# MAX17502E Evaluation Kit

## Evaluate: MAX17502E in TDFN Package

### Component Suppliers

SUPPLIER	PHONE	WEBSITE
Coilcraft, Inc.	847-639-6400	www.coilcraft.com
Murata Electronics North America, Inc.	770-436-1300	www.murata-northamerica.com
Panasonic Corp.	800-344-2112	www.panasonic.com

**Note:** Indicate that you are using the MAX17502 when contacting these component suppliers.

### Quick Start

#### Recommended Equipment

- MAX17502E EV kit
- 4.5V to 60V, 2A DC input power supply
- Load capable of sinking 1A
- Digital voltmeter (DVM)
- Function generator

#### Procedure

The EV kit is fully assembled and tested. Follow the steps below to verify board operation. **Caution: Do not turn on power supply until all connections are completed.**

- 1) Set the power supply at a voltage between 4.5V and 60V. Disable the power supply.
- 2) Connect the positive terminal of the power supply to the VIN PCB pad and the negative terminal to the nearest PGND PCB pad. Connect the positive terminal of the 1A load to the VOUT PCB pad and the negative terminal to the nearest PGND PCB pad.
- 3) Connect the DVM across the VOUT PCB pad and the nearest PGND PCB pad.
- 4) Verify that a shunt is installed across pins 1-2 on jumper JU1.
- 5) Turn on the DC power supply.
- 6) Enable the load.
- 7) Verify that the DVM displays the expected voltage.

To turn on/turn off the part from EN/UVLO, follow the steps below:

- 1) Remove resistors R1 and R2 and the jumper installed across pins 1-2 on jumper JU1.
- 2) Connect the power supply to the EV kit and turn on the power supply. Set the power supply at a voltage between 4.5V and 60V.
- 3) Connect the function generator output to the EN/UVLO test loop.
- 4) EN/UVLO rising threshold is 1.24V and falling threshold is 1.11V. Make sure that the voltage-high and voltage-low levels of the function generator output are greater than 1.24V and less than 1.11V, respectively.
- 5) When powering down the EV kits, first disconnect the function generator output from the EN/UVLO test loop and then turn off the DC power supply.

Care should be taken in board layout and systems wiring to prevent violation of the absolute maximum rating of the FB/VO pin under short-circuit conditions. Under such conditions, it is possible for the ceramic output capacitor to oscillate with the board or wiring inductance between the capacitor and short-circuited load, and thereby cause the absolute maximum rating of FB/VO (-0.3V) to be exceeded. This parasitic board or wiring inductance should be minimized and the output voltage waveform under short-circuit operation should be verified to ensure that the absolute maximum rating of FB/VO is not exceeded.

# MAX17502E Evaluation Kit

## Evaluate: MAX17502E in TDFN Package

### **Detailed Description of Hardware**

The MAX17502E EV kit provides a proven design to evaluate the MAX17502E high-efficiency, high-voltage, synchronous step-down DC-DC converter. The EV kit generates a fixed 3.3V, at load currents up to 1A, from a 4.5V to 60V input supply. The EV kit features a 600kHz fixed switching frequency for optimum efficiency and component size. EV kit features a forced-PWM control scheme that provides constant switching-frequency operation at all load and line conditions.

The EV kit includes an EN/UVLO PCB pad and jumper JU1 to enable control of the converter output. An additional RESET PCB pad is available for monitoring the converter output. The VCC PCB pad helps measure the internal LDO voltage.

### **Soft-Start Input (SS)**

The device utilizes an adjustable soft-start function to limit inrush current during startup. The soft-start time is adjusted by the value of C3, the external capacitor from SS to GND. To adjust the soft-start time, determine C3 using the following formula:

$$C3 = 5.55 \times t_{SS}$$

where  $t_{SS}$  is the required soft-start time in milliseconds and C3 is in nanofarads.

### **Regulator Enable/Undervoltage-Lockout Level (EN/UVLO)**

The device features an EN/UVLO input. For normal operation, a shunt should be installed across pins 1-2 on jumper JU1. To disable the output, install a shunt across pins 2-3 on JU1 and the EN/UVLO pin is pulled to GND. See Table 1 for JU1 settings.

### **Setting the Undervoltage-Lockout Level**

The devices offer an adjustable input undervoltage-lockout level. Set the voltage at which the device turns on with a resistive voltage-divider connected from VIN to GND. Connect the center node of the divider to EN/UVLO.

Choose R1 to be 3.3MΩ and then calculate R2 as follows:

$$R2 = \frac{R1 \times 1.218}{(V_{INU} - 1.218)}$$

where  $V_{INU}$  is the voltage at which the device is required to turn on.

**Table 1. Regulator Enable (EN/UVLO) Jumper JU1 Settings**

SHUNT POSITION	EN/UVLO PIN	MAX17502_ OUTPUT
1-2*	Connected to IN	Enabled
Not installed	Connected to the center node of resistor-divider R1 and R2	Enabled, UVLO level set through the R1 and R2 resistor-divider
2-3	Connected to GND	Disabled

\*Default position.

# MAX17502E Evaluation Kit

## Evaluate: MAX17502E in TDFN Package

### EV Kit Performance Report

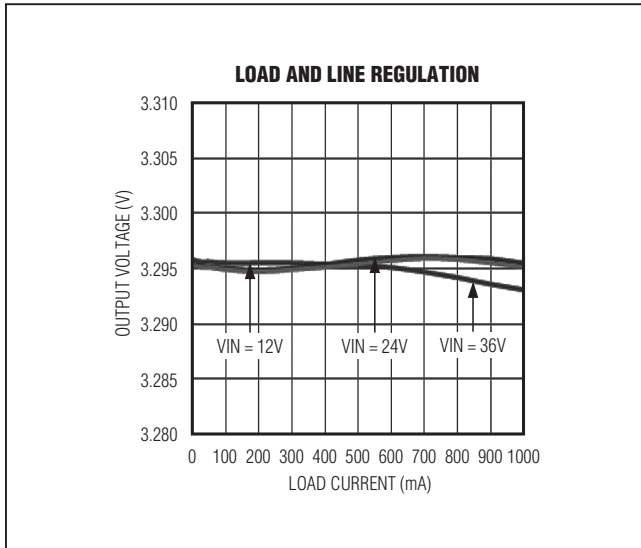

Figure 1. MAX17502E Load and Line Regulation

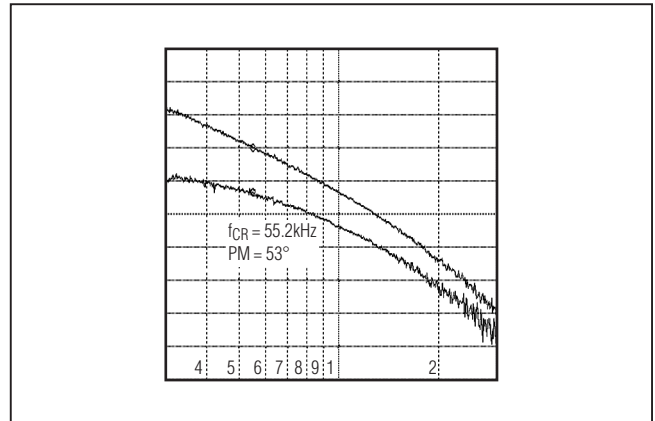

Figure 3. MAX17502E Full-Load Bode Plot (VIN = 24V)

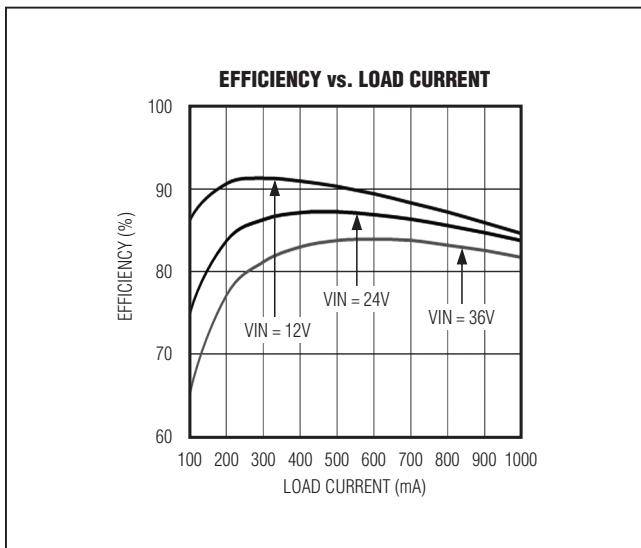

Figure 2. MAX17502E Efficiency

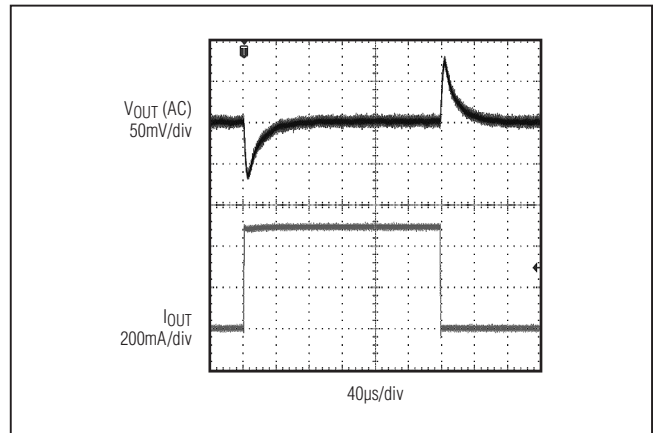

Figure 4. MAX17502E No Load to 500mA Load Transient

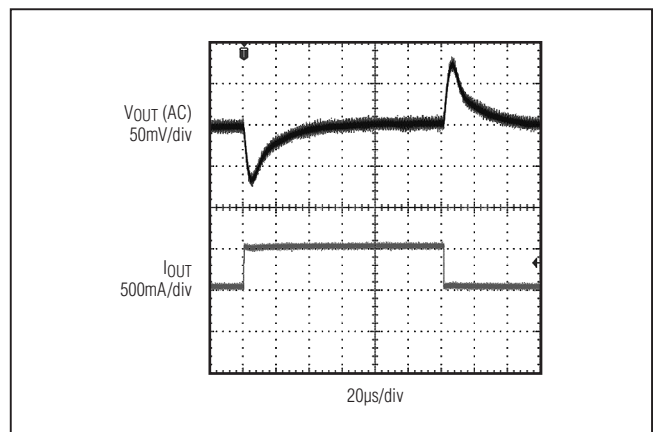

Figure 5. MAX17502E 500mA to 1A Load Transient

# MAX17502E Evaluation Kit

## Evaluate: MAX17502E in TDFN Package

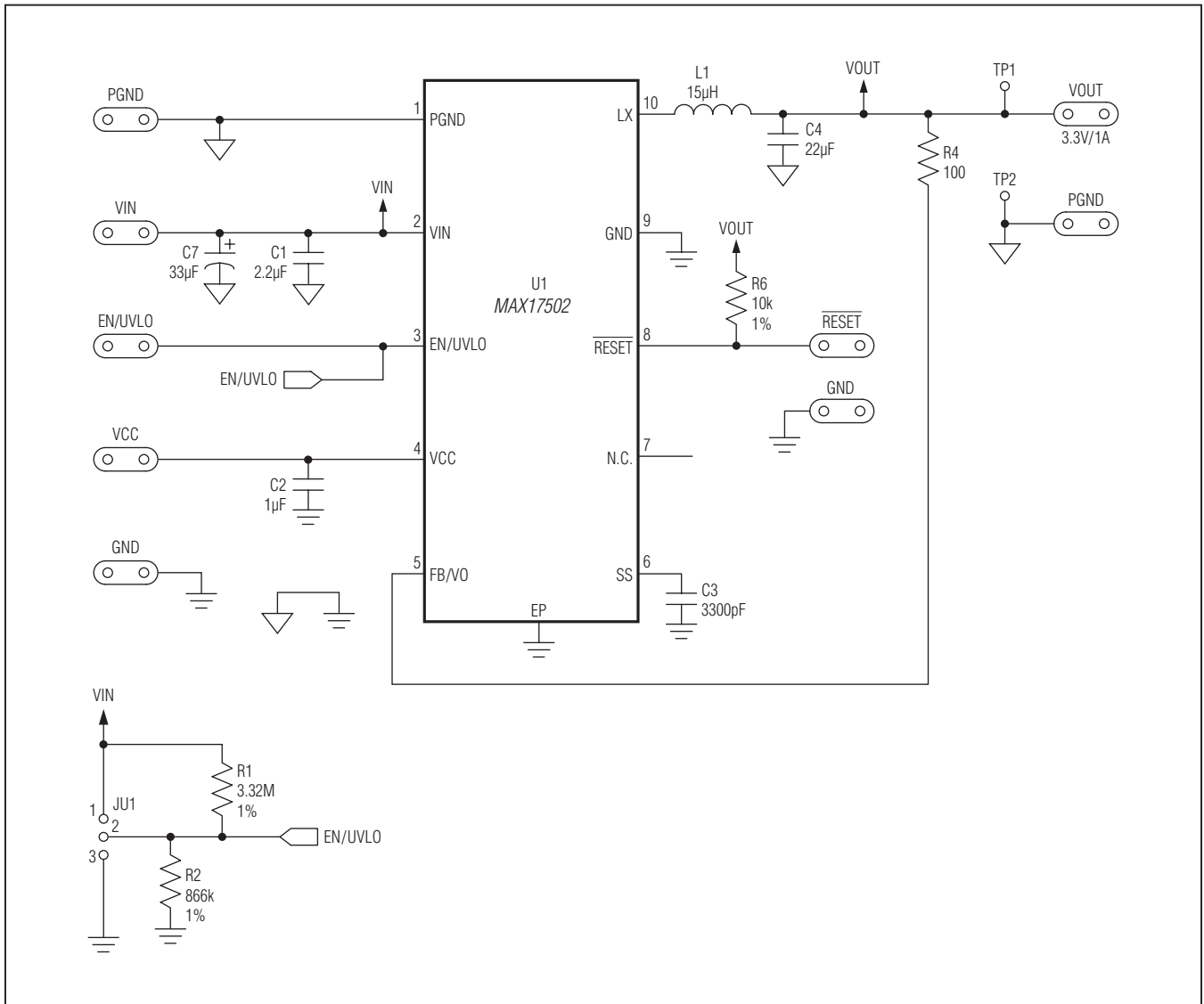

Figure 6. MAX17502E EV Kit Schematic

# MAX17502E Evaluation Kit

## Evaluate: MAX17502E in TDFN Package

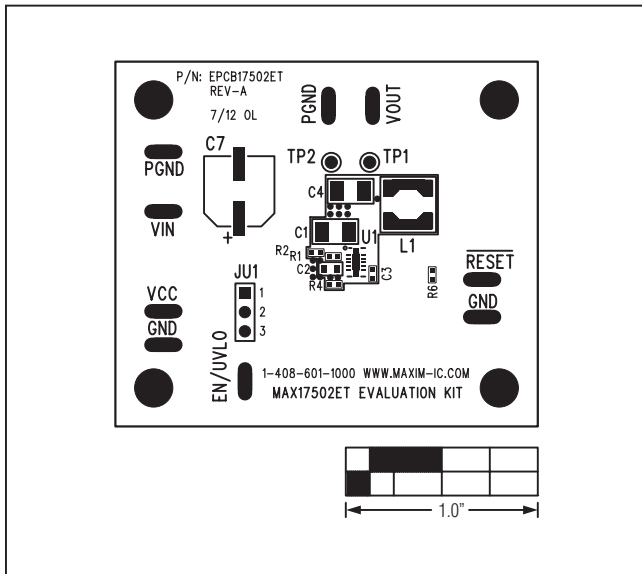

Figure 7. MAX17502E EV Kit Component Placement Guide—Component Side

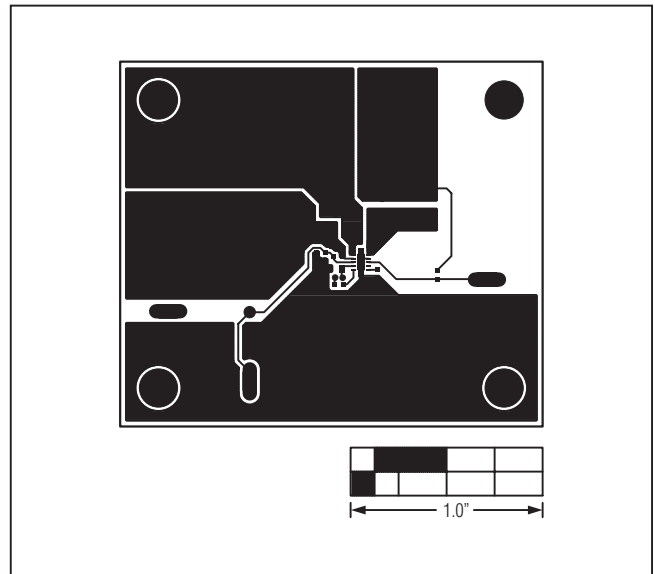

Figure 8. MAX17502E EV Kit PCB Layout—Component Side

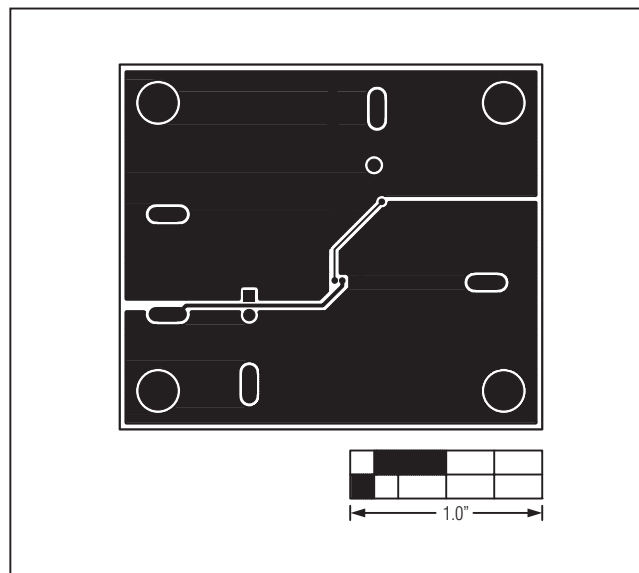

Figure 9. MAX17502E EV Kit PCB Layout—Solder Side

# MAX17502E Evaluation Kit

## Evaluate: MAX17502E in TDFN Package

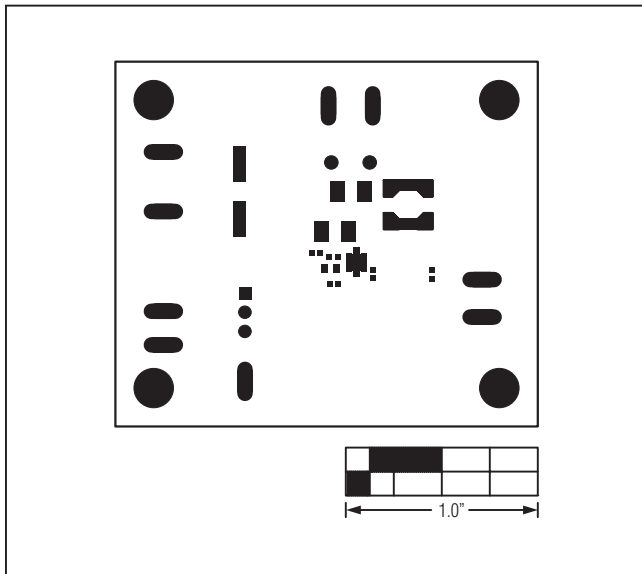

Figure 10. MAX17502E EV Kit PCB Layout—Top Solder Mask

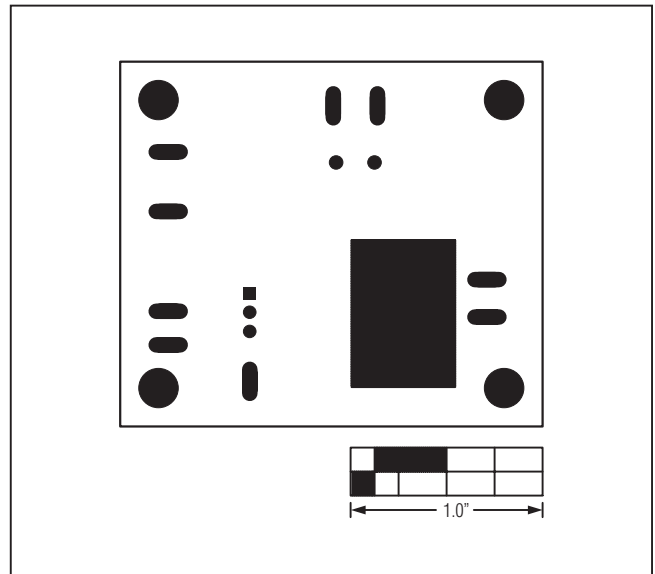

Figure 11. MAX17502E EV Kit PCB Layout—Bottom Solder Mask

# MAX17502E Evaluation Kit

## Evaluate: MAX17502E in TDFN Package

### ***Ordering Information***

---

<b>PART</b>	<b>TYPE</b>
MAX17502ETE VKIT#	EV Kit

#Denotes RoHS compliant.



# MAX17502E Evaluation Kit

## Evaluate: MAX17502E in TDFN Package

### Revision History

REVISION NUMBER	REVISION DATE	DESCRIPTION	PAGES CHANGED
0	10/12	Initial release	—
1	10/13	Replaced the R4 resistor value from 0Ω to 100Ω in the <i>Component List</i> and Figure 6 schematic; added new paragraph to the <i>Procedure</i> section about preventing violation of the abs max rating for FB/VO	1, 2, 5



Maxim Integrated cannot assume responsibility for use of any circuitry other than circuitry entirely embodied in a Maxim Integrated product. No circuit patent licenses are implied. Maxim Integrated reserves the right to change the circuitry and specifications without notice at any time. The parametric values (min and max limits) shown in the Electrical Characteristics table are guaranteed. Other parametric values quoted in this data sheet are provided for guidance.

**Maxim Integrated 160 Rio Robles, San Jose, CA 95134 USA 1-408-601-1000**

9