

BGA713L7

Single-Band UMTS LNA (700, 800 MHz)

Data Sheet

Revision 3.0, 2010-10-04

Edition 2010-10-04

**Published by
Infineon Technologies AG
81726 Munich, Germany**

**© 2010 Infineon Technologies AG
All Rights Reserved.**

Legal Disclaimer

The information given in this document shall in no event be regarded as a guarantee of conditions or characteristics. With respect to any examples or hints given herein, any typical values stated herein and/or any information regarding the application of the device, Infineon Technologies hereby disclaims any and all warranties and liabilities of any kind, including without limitation, warranties of non-infringement of intellectual property rights of any third party.

Information

For further information on technology, delivery terms and conditions and prices, please contact the nearest Infineon Technologies Office (www.infineon.com).

Warnings

Due to technical requirements, components may contain dangerous substances. For information on the types in question, please contact the nearest Infineon Technologies Office.

Infineon Technologies components may be used in life-support devices or systems only with the express written approval of Infineon Technologies, if a failure of such components can reasonably be expected to cause the failure of that life-support device or system or to affect the safety or effectiveness of that device or system. Life support devices or systems are intended to be implanted in the human body or to support and/or maintain and sustain and/or protect human life. If they fail, it is reasonable to assume that the health of the user or other persons may be endangered.

BGA713L7 Single-Band UMTS LNA (700, 800 MHz)

Revision History: 2010-10-04, Revision 3.0

Previous Revision: 2010-05-26, Revision 2.0

Page	Subjects (major changes since last revision)
all	Added UMTS bands XII, XVII and XX specification

Trademarks of Infineon Technologies AG

AURIX™, BlueMoon™, COMNEON™, C166™, CROSSAVE™, CanPAK™, CIPOS™, CoolMOS™, CoolSET™, CORECONTROL™, DAVE™, EasyPIM™, EconoBRIDGE™, EconoDUAL™, EconoPACK™, EconoPIM™, EiceDRIVER™, EUPEC™, FCOS™, HITFET™, HybridPACK™, ISOFACE™, I²RF™, IsoPACK™, MIPAQ™, ModSTACK™, my-d™, NovalithIC™, OmniTune™, OptiMOS™, ORIGA™, PROFET™, PRO-SIL™, PRIMARION™, PrimePACK™, RASIC™, ReverSave™, SatRIC™, SIEGET™, SINDRION™, SMARTi™, SmartLEWIS™, TEMPFET™, thinQ!™, TriCore™, TRENCHSTOP™, X-GOLD™, XMM™, X-PMU™, XPOSYS™.

Other Trademarks

Advance Design System™ (ADS) of Agilent Technologies, AMBA™, ARM™, MULTI-ICE™, PRIMECELL™, REALVIEW™, THUMB™ of ARM Limited, UK. AUTOSAR™ is licensed by AUTOSAR development partnership. Bluetooth™ of Bluetooth SIG Inc. CAT-iq™ of DECT Forum. COLOSSUS™, FirstGPS™ of Trimble Navigation Ltd. EMV™ of EMVCo, LLC (Visa Holdings Inc.). EPCOS™ of Epcos AG. FLEXGO™ of Microsoft Corporation. FlexRay™ is licensed by FlexRay Consortium. HYPERTERMINAL™ of Hilgraeve Incorporated. IEC™ of Commission Electrotechnique Internationale. IrDA™ of Infrared Data Association Corporation. ISO™ of INTERNATIONAL ORGANIZATION FOR STANDARDIZATION. MATLAB™ of MathWorks, Inc. MAXIM™ of Maxim Integrated Products, Inc. MICROTEC™, NUCLEUS™ of Mentor Graphics Corporation. Mifare™ of NXP. MIPI™ of MIPI Alliance, Inc. MIPS™ of MIPS Technologies, Inc., USA. muRata™ of MURATA MANUFACTURING CO., MICROWAVE OFFICE™ (MWO) of Applied Wave Research Inc., OmniVision™ of OmniVision Technologies, Inc. Openwave™ Openwave Systems Inc. RED HAT™ Red Hat, Inc. RFMD™ RF Micro Devices, Inc. SIRIUS™ of Sirius Sattelite Radio Inc. SOLARIS™ of Sun Microsystems, Inc. SPANSION™ of Spansion LLC Ltd. Symbian™ of Symbian Software Limited. TAIYO YUDEN™ of Taiyo Yuden Co. TEAKLITE™ of CEVA, Inc. TEKTRONIX™ of Tektronix Inc. TOKO™ of TOKO KABUSHIKI KAISHA TA. UNIX™ of X/Open Company Limited. VERILOG™, PALLADIUM™ of Cadence Design Systems, Inc. VLYNQ™ of Texas Instruments Incorporated. VXWORKS™, WIND RIVER™ of WIND RIVER SYSTEMS, INC. ZETEX™ of Diodes Zetex Limited.

Last Trademarks Update 2010-06-09

Table of Contents

	Table of Contents	4
	List of Figures	5
	List of Tables	6
1	Features	7
2	Electrical Characteristics	9
2.1	Absolute Maximum Ratings	9
2.2	Thermal Resistance	9
2.3	ESD Integrity	9
2.4	DC Characteristics	10
2.5	Band Select / Gain Control Truth Table	10
2.6	Switching Time	10
2.7	Supply Current and Power Gain Characteristics	11
2.8	Logic Signal Characteristics	11
2.9	Measured RF Characteristics UMTS Bands XII / XVII	12
2.10	Measured RF Characteristics UMTS Bands XIII / XIV	13
2.11	Measured RF Characteristics UMTS Band XX	14
2.12	Measured Performance Band XIII High Gain Mode vs. Frequency	15
2.13	Measured Performance Band XIII High Gain Mode vs. Temperature	16
2.14	Measured Performance Band XIII Low Gain Mode vs. Frequency	17
2.15	Measured Performance Band XIII Low Gain Mode vs. Temperature	18
3	Application Circuit and Block Diagram	19
3.1	UMTS Bands XII and XVII Application Circuit Schematic	19
3.2	UMTS Bands XIII and XIV Application Circuit Schematic	20
3.3	UMTS Bands XX Application Circuit Schematic	21
3.4	Pin Description	22
3.5	Application Board	23
4	Physical Characteristics	25
4.1	Package Footprint	25
4.2	Package Dimensions	25
4.3	Product Marking Pattern	26

List of Figures

Figure 1	Block Diagram of Single-Band LNA	8
Figure 2	Application Circuit with Chip Outline (top view)	19
Figure 3	Application Circuit with Chip Outline (top view)	20
Figure 4	Application Circuit with Chip Outline (top view)	21
Figure 5	Application Board Layout on 3-layer FR4	23
Figure 6	Cross-Section view of Application Board	23
Figure 7	Detail of Application Board Layout	24
Figure 8	Recommended Footprint and Stencil Layout for the TSLP-7-1 Package	25
Figure 9	Package Outline (top, side and bottom view)	25
Figure 10	Marking Pattern (top view)	26

List of Tables

Table 1	Absolute Maximum Ratings	9
Table 2	Thermal Resistance	9
Table 3	ESD Integrity	9
Table 4	DC Characteristics, $T_A = 25\text{ }^\circ\text{C}$	10
Table 5	Truth Table	10
Table 6	Typical switching times; $T_A = -30 \dots 85\text{ }^\circ\text{C}$	10
Table 7	Typical Characteristics 700 MHz Band, $T_A = 25\text{ }^\circ\text{C}$, $V_{CC} = 2.8\text{ V}$, $R_{REF} = 5.6\text{ k}\Omega$	12
Table 8	Typical Characteristics 700 MHz Band, $T_A = 25\text{ }^\circ\text{C}$, $V_{CC} = 2.8\text{ V}$, $R_{REF} = 5.6\text{ k}\Omega$	13
Table 9	Typical Characteristics 800 MHz Band, $T_A = 25\text{ }^\circ\text{C}$, $V_{CC} = 2.8\text{ V}$, $R_{REF} = 5.6\text{ k}\Omega$	14
Table 10	Parts List	19
Table 11	Parts List	20
Table 12	Parts List	21
Table 13	Pin Definition and Function	22

1 Features

Main features:

- Gain: 15.5 / -10 dB in high / low gain mode
- Noise figure: 1.1 dB in high gain mode
- Supply current: 4.8 / 0.5 mA in high / low gain mode
- Standby mode (< 2 μ A typ.)
- Output internally matched to 50 Ω
- Inputs pre-matched to 50 Ω
- 2 kV HBM ESD protection
- Low external component count
- Small leadless TSLP-7-1 package (2.0 x 1.3 x 0.39 mm)
- Pb-free (RoHS compliant) package



Description

The BGA713L7 is a low current single-band low noise amplifier MMIC for UMTS bands XII, XIII, XIV, XVII and XX. The LNA is based upon Infineon's proprietary and cost-effective SiGe:C technology and comes in a low profile TSLP-7-1 leadless green package. This document specifies electrical parameters, pinout, application circuit and packaging of the chip.

Product Name	Package	Chip	Marking
BGA713L7	TSLP-7-1	T1533	B3

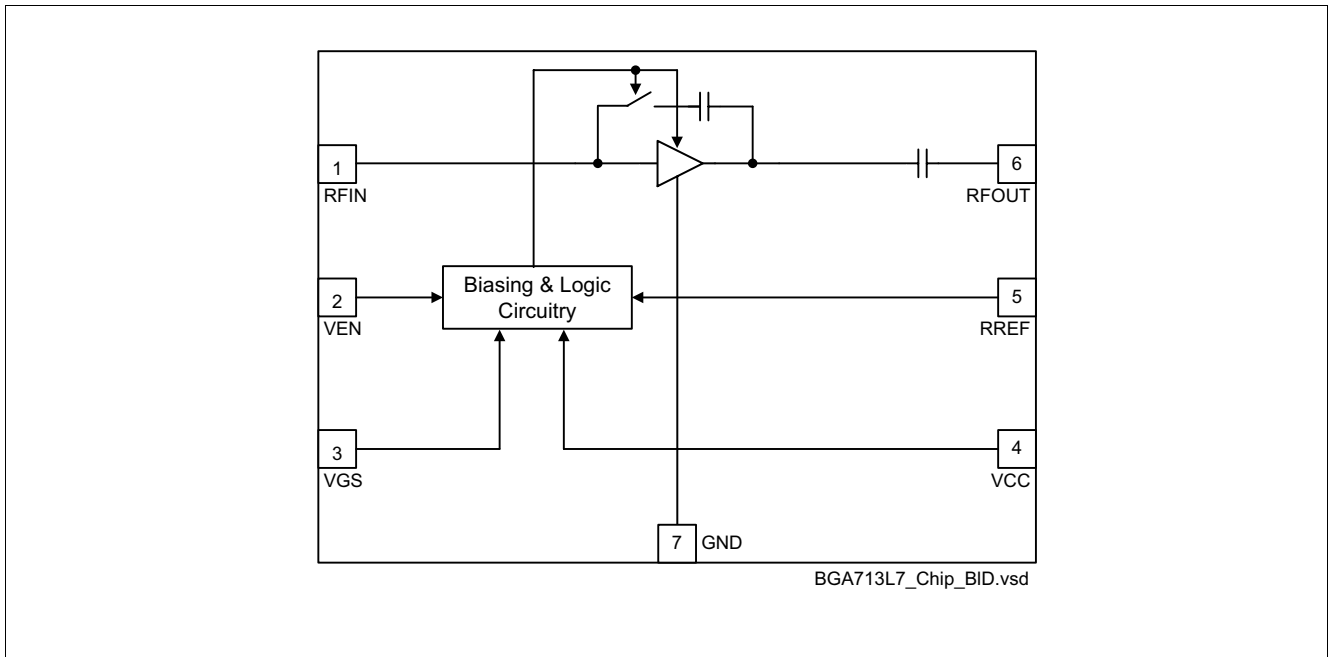

Figure 1 Block Diagram of Single-Band LNA

2 Electrical Characteristics

2.1 Absolute Maximum Ratings

Table 1 Absolute Maximum Ratings

Parameter	Symbol	Values			Unit	Note / Test Condition
		Min.	Typ.	Max.		
Supply voltage	V_{CC}	-0.3	–	3.6	V	–
Supply current	I_{CC}	–	–	10	mA	–
Pin voltage	V_{PIN}	-0.3	–	$V_{CC}+0.3$	V	All pins except RF input pins
Pin voltage RF input pins	V_{RFIN}	-0.3	–	0.9	V	–
RF input power	P_{RFIN}	–	–	4	dBm	–
Junction temperature	T_j	–	–	150	°C	–
Ambient temperature range	T_A	-30	–	85	°C	–
Storage temperature range	T_{stg}	-65	–	150	°C	–

Attention: Stresses above the max. values listed here may cause permanent damage to the device. Exposure to absolute maximum rating conditions for extended periods may affect device reliability. Maximum ratings are absolute ratings; exceeding only one of these values may cause irreversible damage to the integrated circuit.

2.2 Thermal Resistance

Table 2 Thermal Resistance

Parameter	Symbol	Values			Unit	Note / Test Condition
		Min.	Typ.	Max.		
Thermal resistance junction to soldering point	R_{thJS}	–	150	–	K/W	–

2.3 ESD Integrity

Table 3 ESD Integrity

Parameter	Symbol	Values			Unit	Note / Test Condition
		Min.	Typ.	Max.		
ESD hardness HBM ¹⁾	$V_{ESD-HBM}$	–	2000	–	V	All pins

1) According to JESD22-A114

2.4 DC Characteristics

Table 4 DC Characteristics, $T_A = 25\text{ °C}$

Parameter	Symbol	Values			Unit	Note / Test Condition
		Min.	Typ.	Max.		
Supply voltage	V_{CC}	2.6	2.8	3.0	V	–
Supply current high gain mode	I_{CCHG}	–	4.8	–	mA	–
Supply current low gain mode	I_{CCLG}	–	0.50	–	mA	–
Supply current standby mode	I_{CCOFF}	–	0.1	–	μA	–
Logic level high	V_{HI}	1.5	2.8	–	V	All logic pins
Logic level low	V_{LO}	–	0.0	0.5	V	
Logic currents	I_{HI}	–	5.0	–	μA	All logic pins
	I_{LO}	–	0.1	–	μA	

2.5 Band Select / Gain Control Truth Table

Table 5 Truth Table

Control Voltage		State	
		Bands XII, XIII, XIV, XVII and XX	
VEN	VGS	HG	LG
H	L	OFF	ON
H	H	ON	OFF
L	L	STANDBY ¹⁾	
L	H		

1) In order to achieve minimum standby current it is encouraged to apply logic low-level at the VGS pin in standby mode although this is not mandatory.

2.6 Switching Time

Table 6 Typical switching times; $T_A = -30 \dots 85\text{ °C}$

Parameter	Symbol	Values			Unit	Note / Test Condition
		Min.	Typ.	Max.		
Settling time gainstep	t_{GS}	–	1	–	μs	Switching LG \leftrightarrow HG

2.7 Supply Current and Power Gain Characteristics

Supply current high gain mode versus resistance of reference resistor R_{REF} see Figure 3 on Page 20; low gain mode supply current is independent of reference resistor).

Supply Current $I_{CC} = f(R_{REF})$
 $V_{CC} = 2.8\text{ V}$

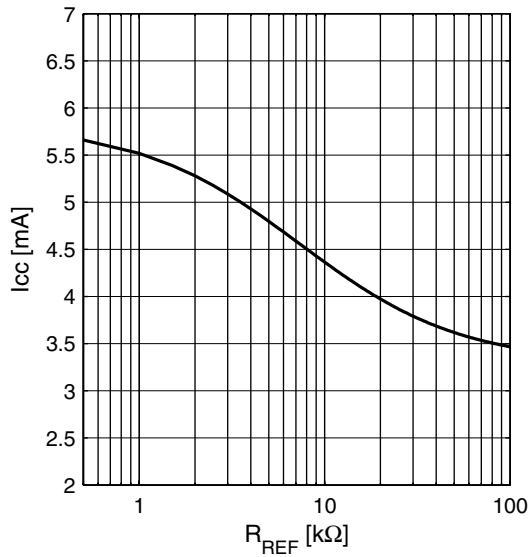

Power Gain $|S_{21}| = f(R_{REF})$
 $V_{CC} = 2.8\text{ V}$

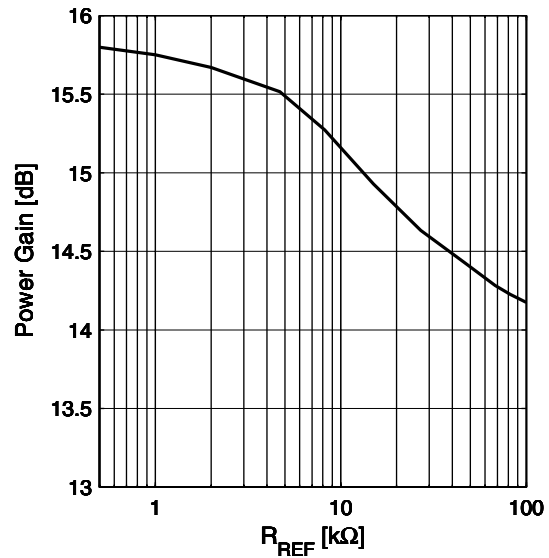

2.8 Logic Signal Characteristics

Current consumption of logic inputs VEN, VGS

Logic currents $I_{EN} = f(V_{EN})$
 $V_{CC} = 2.8\text{ V}$

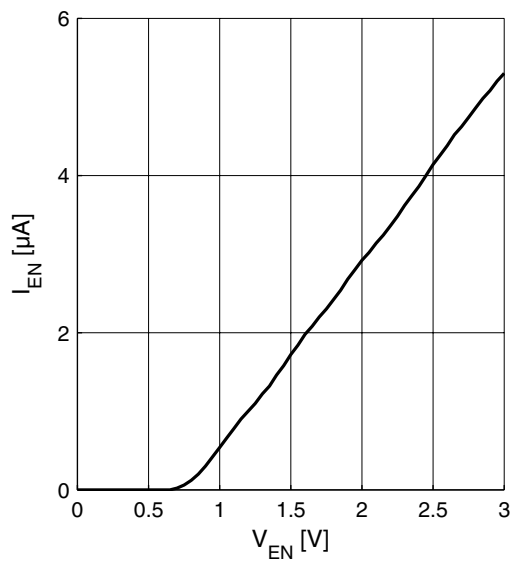

Logic currents $I_{GS} = f(V_{GS})$
 $V_{CC} = 2.8\text{ V}$

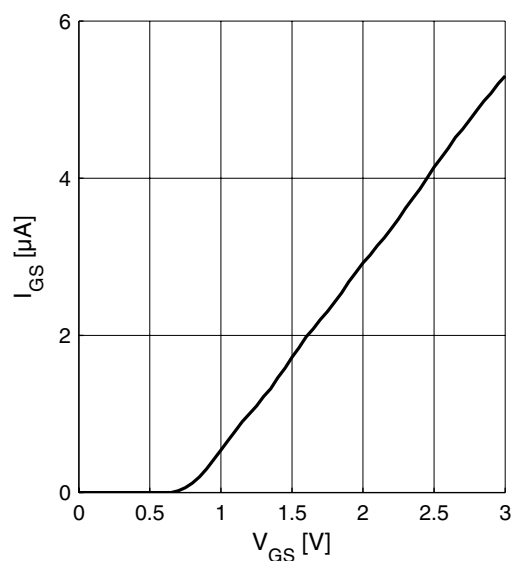

2.9 Measured RF Characteristics UMTS Bands XII / XVII

Table 7 Typical Characteristics 700 MHz Band, $T_A = 25\text{ °C}$, $V_{CC} = 2.8\text{ V}$, $R_{REF} = 5.6\text{ k}\Omega$ ¹⁾

Parameter	Symbol	Values			Unit	Note / Test Condition
		Min.	Typ.	Max.		
Pass band range band XII		728		746	MHz	
Pass band range band XVII		734		746	MHz	
Current consumption	I_{CCHG}	–	4.8	–	mA	High gain mode
	I_{CCLG}	–	0.50	–	mA	Low gain mode
Gain	S_{21HG}	–	15.3	–	dB	High gain mode
	S_{21LG}	–	-9.9	–	dB	Low gain mode
Reverse isolation ²⁾	S_{12HG}	–	-40	–	dB	High gain mode
	S_{12LG}	–	-9.9	–	dB	Low gain mode
Noise figure	NF_{HG}	–	1.1	–	dB	High gain mode
	NF_{LG}	–	9.9	–	dB	Low gain mode
Input return loss ²⁾	S_{11HG}	–	-13	–	dB	50 Ω , high gain mode
	S_{11LG}	–	-14	–	dB	50 Ω , low gain mode
Output return loss ²⁾	S_{22HG}	–	-27	–	dB	50 Ω , high gain mode
	S_{22LG}	–	-19	–	dB	50 Ω , low gain mode
Stability factor ³⁾	k	–	>2.2	–		DC to 8 GHz; all gain modes
Input compression point ²⁾	IP_{1dBHG}	–	-7	–	dBm	High gain mode
	$IP_{1dB LG}$	–	-12	–	dBm	Low gain mode
Inband IIP3 ²⁾ $f_1 - f_2 = 1\text{ MHz}$ $P_{f1} = P_{f2} = -37\text{ dBm}$	$IIP3_{HG}$	–	-8	–	dBm	High gain mode
	$IIP3_{LG}$	–	-2	–	dBm	Low gain mode

1) Performance based on application circuit in Figure 2 on Page 19

2) Verification based on AQL; not 100% tested in production

3) Guaranteed by device design; not tested in production

2.10 Measured RF Characteristics UMTS Bands XIII / XIV

Table 8 Typical Characteristics 700 MHz Band, $T_A = 25\text{ °C}$, $V_{CC} = 2.8\text{ V}$, $R_{REF} = 5.6\text{ k}\Omega$ ¹⁾

Parameter	Symbol	Values			Unit	Note / Test Condition
		Min.	Typ.	Max.		
Pass band range band XIII		746		756	MHz	
Pass band range band XIV		758		768	MHz	
Current consumption	I_{CCHG}	–	4.8	–	mA	High gain mode
	I_{CCLG}	–	0.50	–	mA	Low gain mode
Gain	S_{21HG}	–	15.5	–	dB	High gain mode
	S_{21LG}	–	-9.8	–	dB	Low gain mode
Reverse isolation ²⁾	S_{12HG}	–	-39	–	dB	High gain mode
	S_{12LG}	–	-9.8	–	dB	Low gain mode
Noise figure	NF_{HG}	–	1.1	–	dB	High gain mode
	NF_{LG}	–	9.8	–	dB	Low gain mode
Input return loss ²⁾	S_{11HG}	–	-15	–	dB	50 Ω , high gain mode
	S_{11LG}	–	-12	–	dB	50 Ω , low gain mode
Output return loss ²⁾	S_{22HG}	–	-15	–	dB	50 Ω , high gain mode
	S_{22LG}	–	-20	–	dB	50 Ω , low gain mode
Stability factor ³⁾	k	–	>2.3	–		DC to 8 GHz; all gain modes
Input compression point ²⁾	IP_{1dBHG}	–	-7	–	dBm	High gain mode
	$IP_{1dB LG}$	–	-11	–	dBm	Low gain mode
Inband IIP3 ²⁾ $f_1 - f_2 = 1\text{ MHz}$ $P_{f1} = P_{f2} = -37\text{ dBm}$	$IIP3_{HG}$	–	-7	–	dBm	High gain mode
	$IIP3_{LG}$	–	-2	–	dBm	Low gain mode

1) Performance based on application circuit in Figure 3 on Page 20

2) Verification based on AQL; not 100% tested in production

3) Guaranteed by device design; not tested in production

2.11 Measured RF Characteristics UMTS Band XX

Table 9 Typical Characteristics 800 MHz Band, $T_A = 25\text{ °C}$, $V_{CC} = 2.8\text{ V}$, $R_{REF} = 5.6\text{ k}\Omega$ ¹⁾

Parameter	Symbol	Values			Unit	Note / Test Condition
		Min.	Typ.	Max.		
Pass band range		791		821	MHz	
Current consumption	I_{CCHG}	–	4.8	–	mA	High gain mode
	I_{CCLG}	–	0.50	–	mA	Low gain mode
Gain	S_{21HG}	–	15.9	–	dB	High gain mode
	S_{21LG}	–	-8.4	–	dB	Low gain mode
Reverse isolation ²⁾	S_{12HG}	–	-38	–	dB	High gain mode
	S_{12LG}	–	-8.4	–	dB	Low gain mode
Noise figure	NF_{HG}	–	1.0	–	dB	High gain mode
	NF_{LG}	–	8.4	–	dB	Low gain mode
Input return loss ²⁾	S_{11HG}	–	-16	–	dB	50 Ω , high gain mode
	S_{11LG}	–	-11	–	dB	50 Ω , low gain mode
Output return loss ²⁾	S_{22HG}	–	-13	–	dB	50 Ω , high gain mode
	S_{22LG}	–	-27	–	dB	50 Ω , low gain mode
Stability factor ³⁾	k	–	>2.3	–		DC to 8 GHz; all gain modes
Input compression point ²⁾	IP_{1dBHG}	–	-6	–	dBm	High gain mode
	$IP_{1dB LG}$	–	-10	–	dBm	Low gain mode
Inband IIP3 ²⁾ $f_1 - f_2 = 1\text{ MHz}$ $P_{f1} = P_{f2} = -37\text{ dBm}$	$IIP3_{HG}$	–	-8	–	dBm	High gain mode
	$IIP3_{LG}$	–	-1	–	dBm	Low gain mode

1) Performance based on application circuit in Figure 4 on Page 21

2) Verification based on AQL; not 100% tested in production

3) Guaranteed by device design; not tested in production

2.12 Measured Performance Band XIII High Gain Mode vs. Frequency

$T_A = 25\text{ }^\circ\text{C}$, $V_{CC} = 2.8\text{ V}$, $V_{GS} = 2.8\text{ V}$, $V_{EN} = 2.8\text{ V}$, $R_{REF} = 5.6\text{ k}\Omega$

Power Gain $|S_{21}| = f(f)$

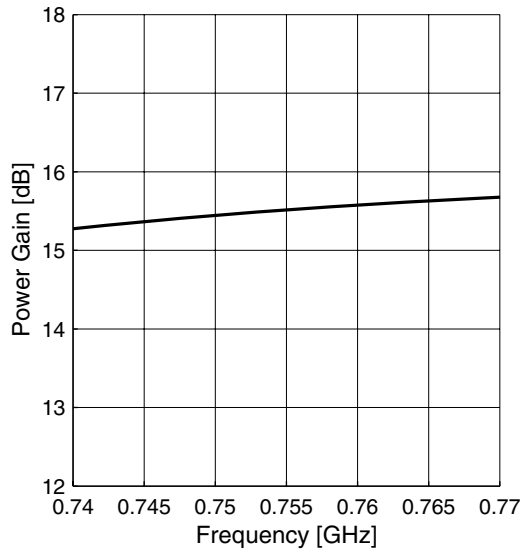

Power Gain wideband $|S_{21}| = f(f)$

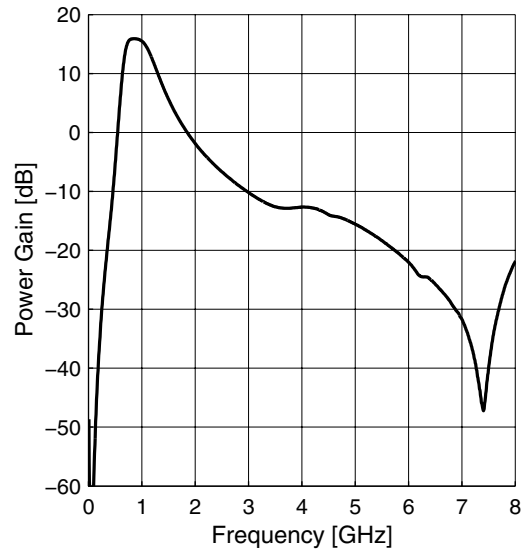

Matching $|S_{11}| = f(f)$, $|S_{22}| = f(f)$

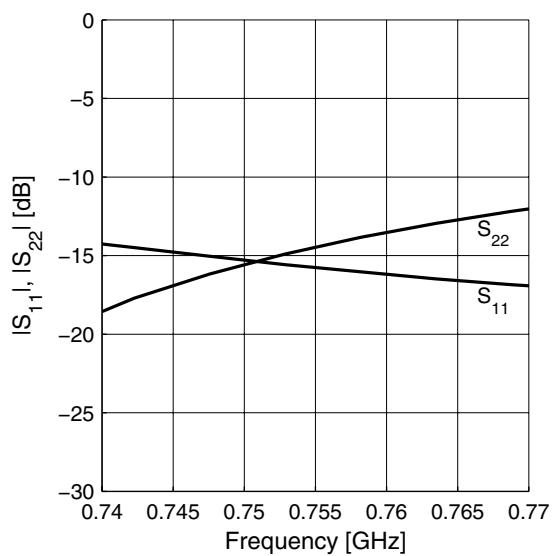

Noise Figure $NF = f(f)$

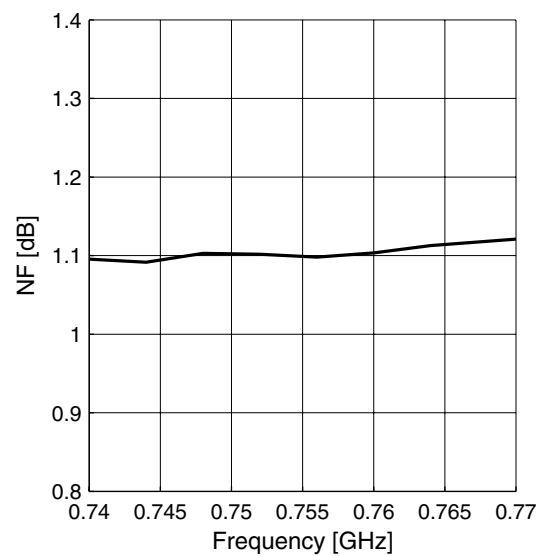

2.13 Measured Performance Band XIII High Gain Mode vs. Temperature

$V_{CC} = 2.8\text{ V}$, $V_{GS} = 2.8\text{ V}$, $V_{EN} = 2.8\text{ V}$, $f = 750\text{ MHz}$, $R_{REF} = 5.6\text{ k}\Omega$

Power Gain $|S_{21}| = f(T_A)$

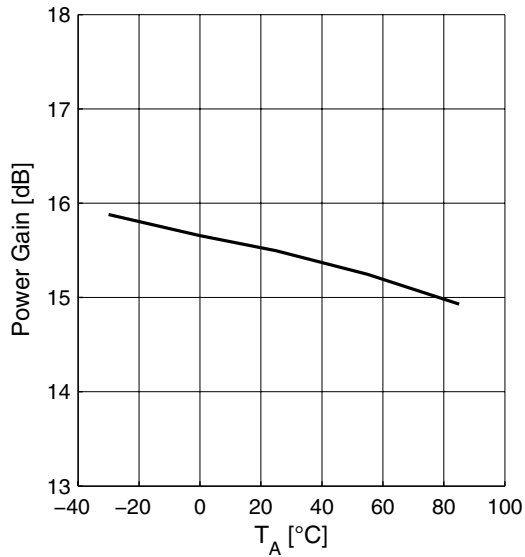

Supply Current $I_{CC} = f(T_A)$

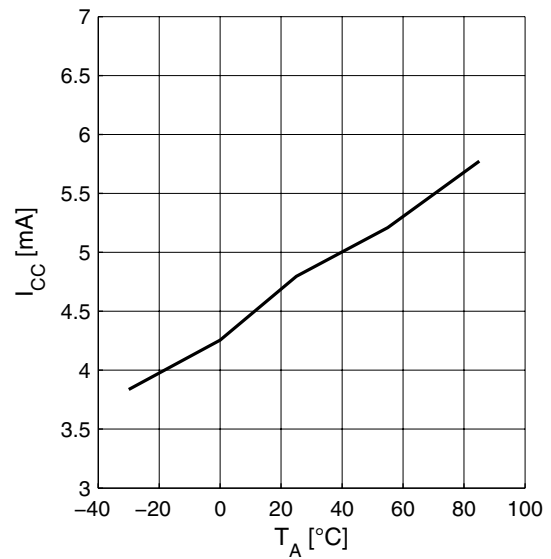

Input Compression $P1dB = f(T_A)$

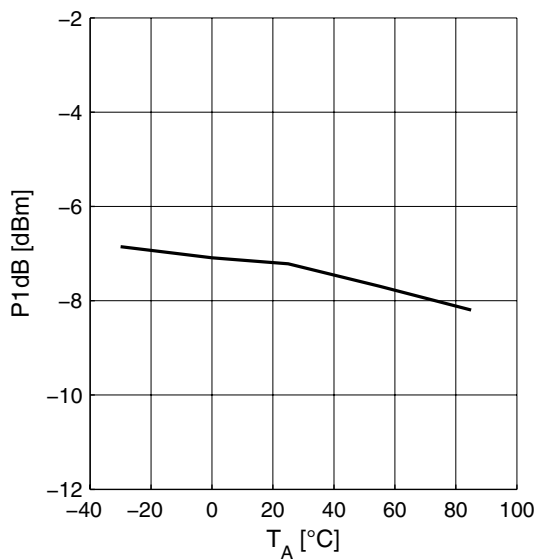

Noise Figure $NF = f(T_A)$

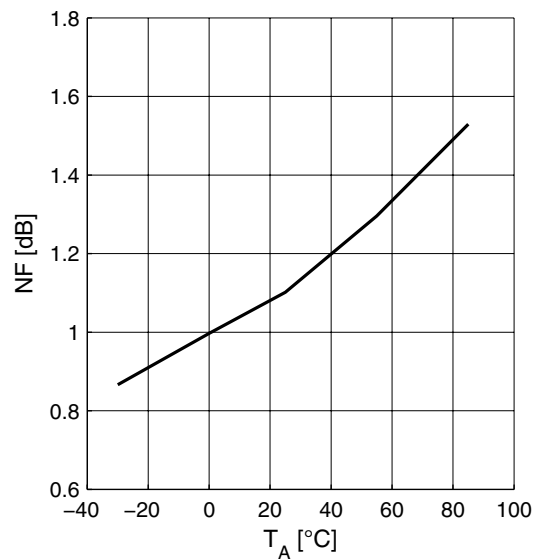

2.14 Measured Performance Band XIII Low Gain Mode vs. Frequency

$T_A = 25\text{ }^\circ\text{C}$, $V_{CC} = 2.8\text{ V}$, $V_{GS} = 0\text{ V}$, $V_{EN} = 2.8\text{ V}$, $R_{REF} = 5.6\text{ k}\Omega$

Power Gain $|S_{21}| = f(f)$

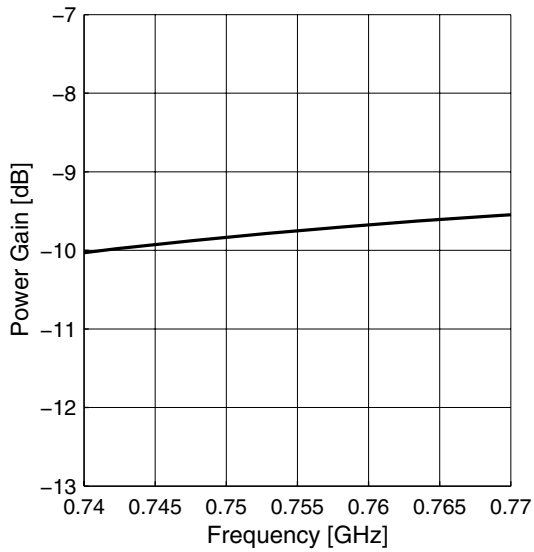

Power Gain wideband $|S_{21}| = f(f)$

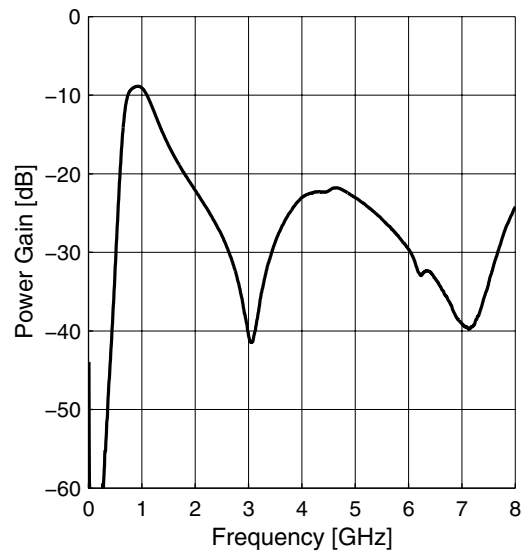

Matching $|S_{11}| = f(f)$, $|S_{22}| = f(f)$

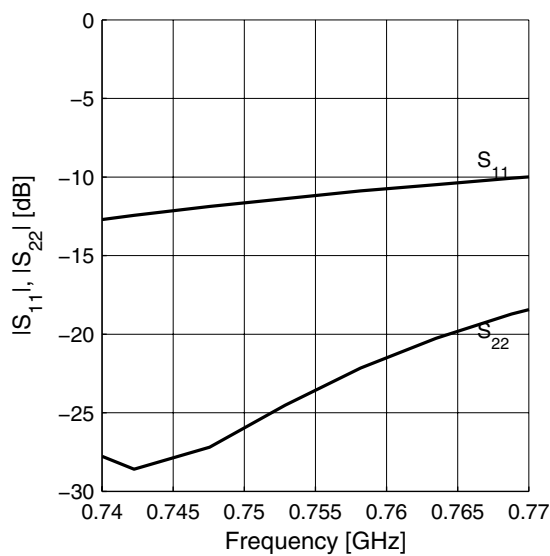

Noise Figure $NF = f(f)$

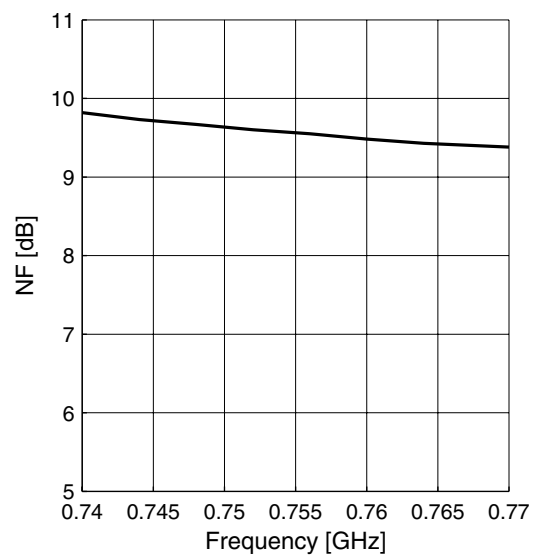

2.15 Measured Performance Band XIII Low Gain Mode vs. Temperature

$V_{CC} = 2.8 \text{ V}$, $V_{GS} = 0 \text{ V}$, $V_{EN} = 2.8 \text{ V}$, $f = 750 \text{ MHz}$, $R_{REF} = 5.6 \text{ k}\Omega$

Power Gain $|S_{21}| = f(T_A)$

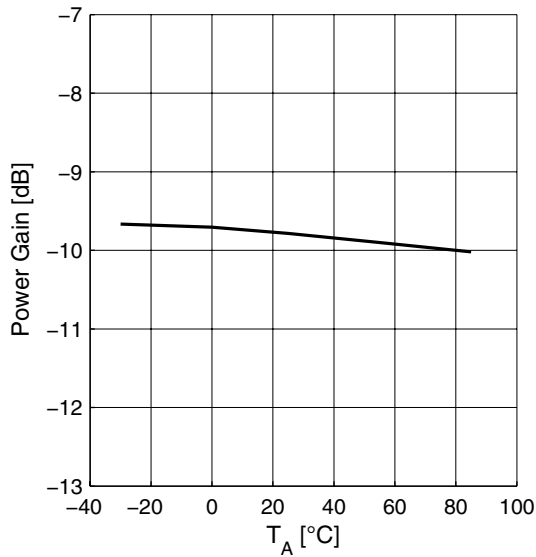

Supply Current $I_{CC} = f(T_A)$

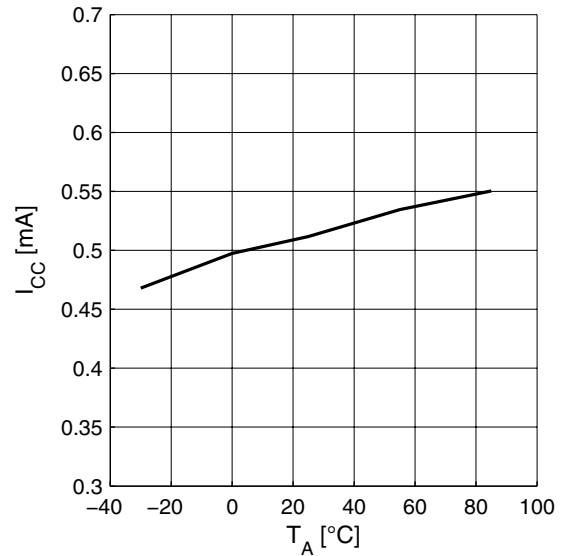

Input Compression $P1dB = f(T_A)$

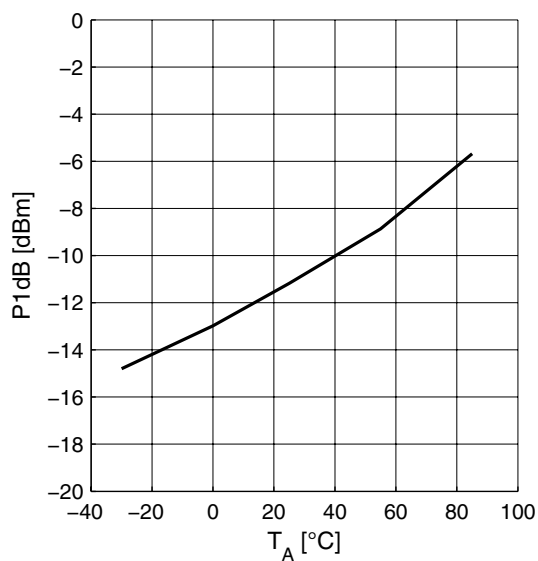

Noise Figure $NF = f(T_A)$

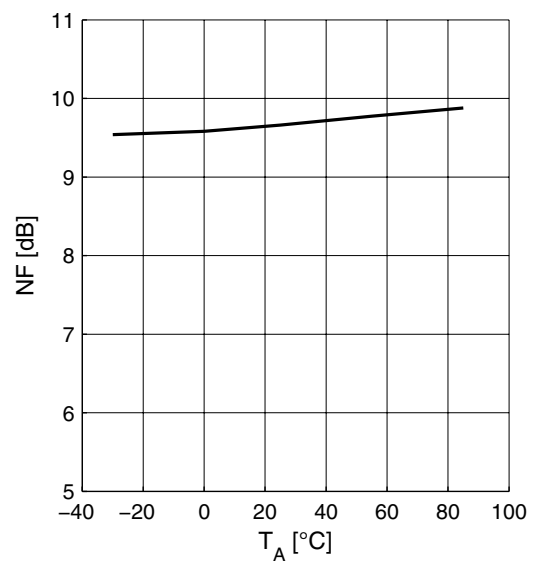

3 Application Circuit and Block Diagram

3.1 UMTS Bands XII and XVII Application Circuit Schematic

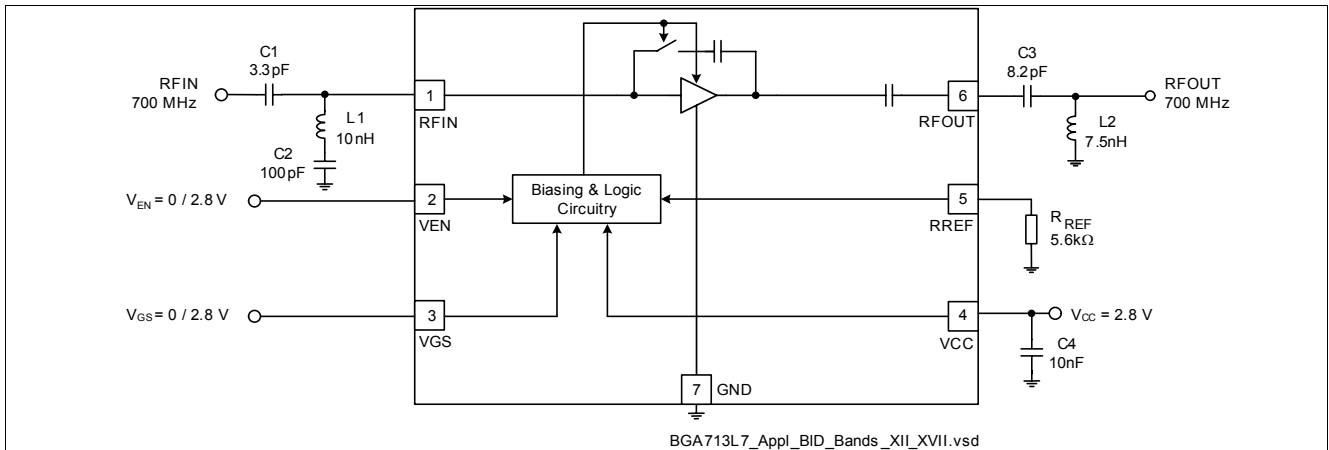

Figure 2 Application Circuit with Chip Outline (top view)

Note: Package paddle (Pin 7) has to be RF grounded.

Table 10 Parts List

Part Number	Part Type	Manufacturer	Size	Comment
L1 ... L2	Chip inductor	Various	0402	Wirewound, Q ≈ 50
C1 ... C4	Chip capacitor	Various	0402	
RREF	Chip resistor	Various	0402	

3.2 UMTS Bands XIII and XIV Application Circuit Schematic

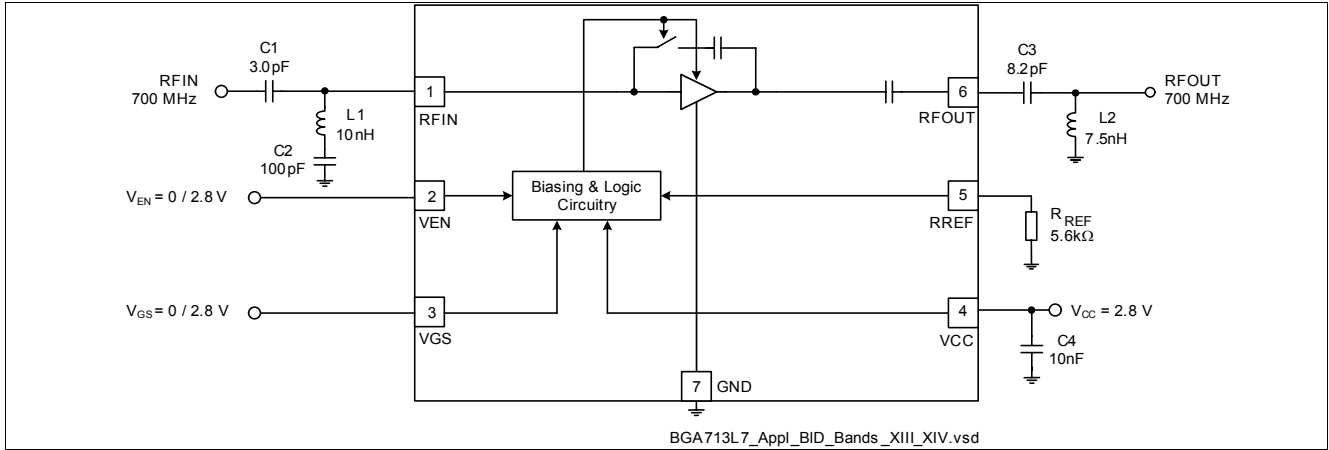

Figure 3 Application Circuit with Chip Outline (top view)

Note: Package paddle (Pin 7) has to be RF grounded.

Table 11 Parts List

Part Number	Part Type	Manufacturer	Size	Comment
L1 ... L2	Chip inductor	Various	0402	Wirewound, Q ≈ 50
C1 ... C4	Chip capacitor	Various	0402	
RREF	Chip resistor	Various	0402	

3.3 UMTS Bands XX Application Circuit Schematic

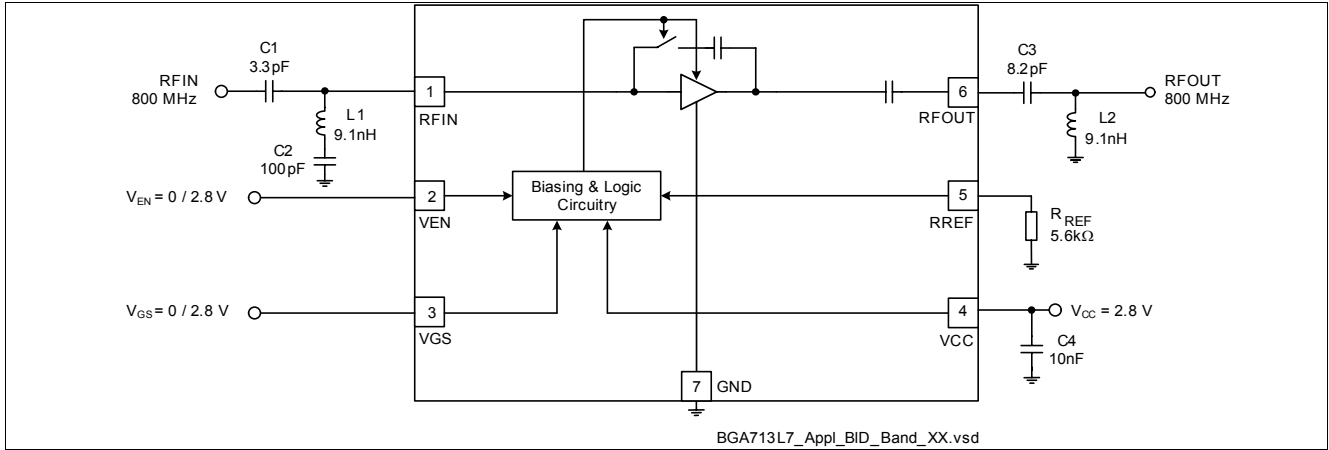

Figure 4 Application Circuit with Chip Outline (top view)

Note: Package paddle (Pin 7) has to be RF grounded.

Table 12 Parts List

Part Number	Part Type	Manufacturer	Size	Comment
L1 ... L2	Chip inductor	Various	0402	Wirewound, Q ≈ 50
C1 ... C4	Chip capacitor	Various	0402	
RREF	Chip resistor	Various	0402	

3.4 Pin Description

Table 13 Pin Definition and Function

Pin No.	Name	Pin Type	Buffer Type	Function
1	RFIN			LNA input
2	VEN			Band select control
3	VGS			Gain step control
4	VCC			Supply voltage
5	RREF			Bias current reference resistor (high gain mode)
6	RFOUT			LNA output
7	GND			Ground Package paddle; ground connection and control circuitry

3.5 Application Board

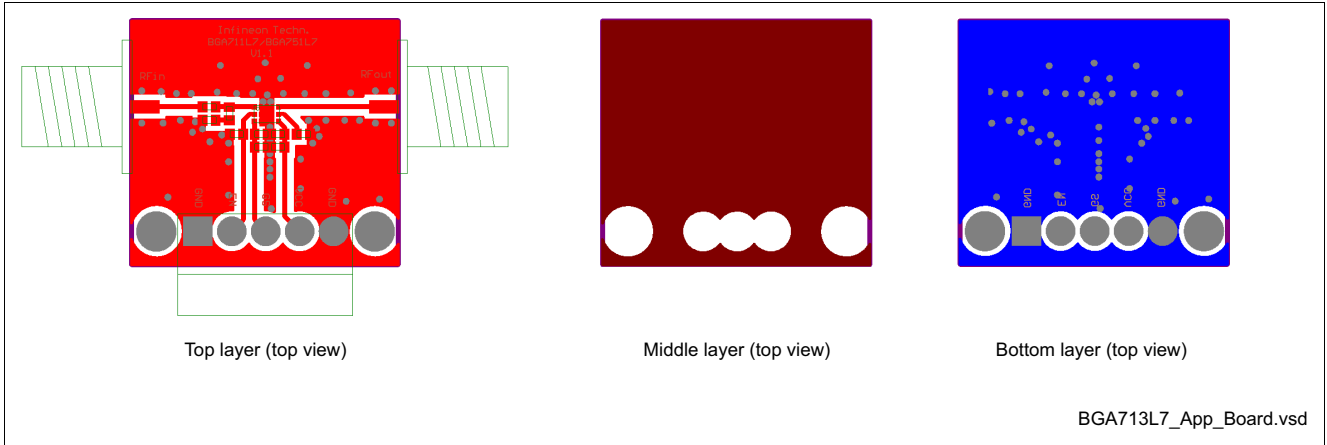

Figure 5 Application Board Layout on 3-layer FR4

Note: Top layer thickness: 0.2 mm, bottom layer thickness: 0.8 mm, 17 mm Cu metallization, gold plated. Board size: 21 x 18 mm.

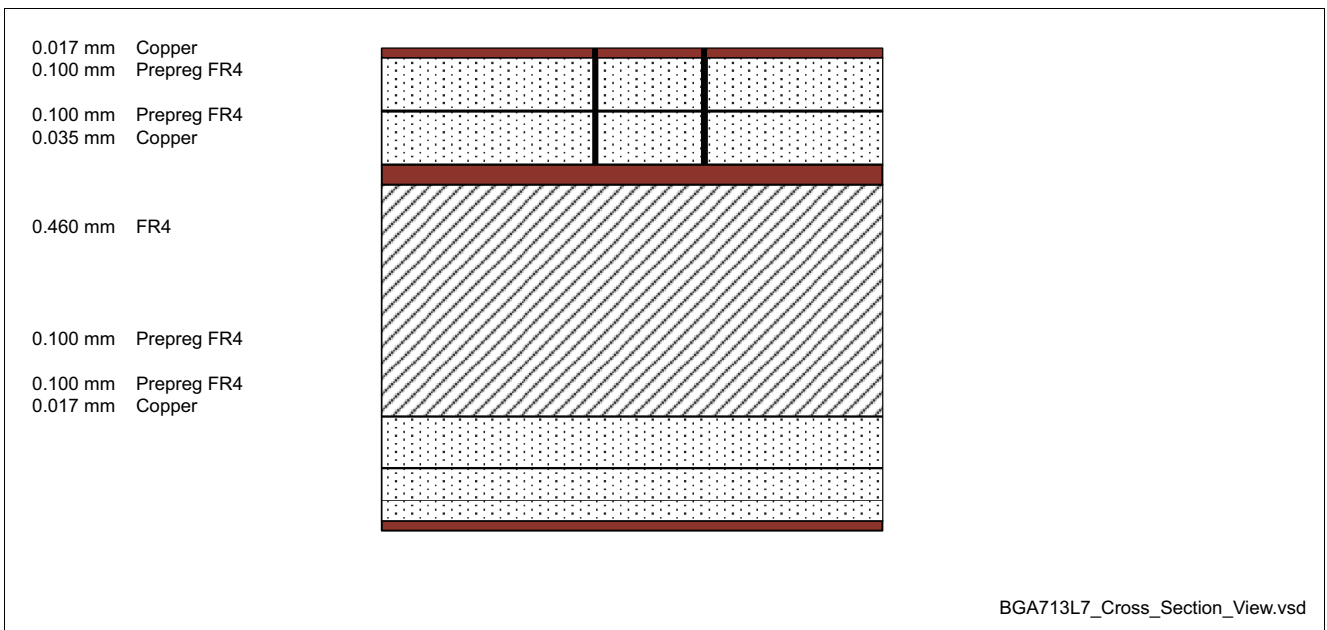

Figure 6 Cross-Section view of Application Board

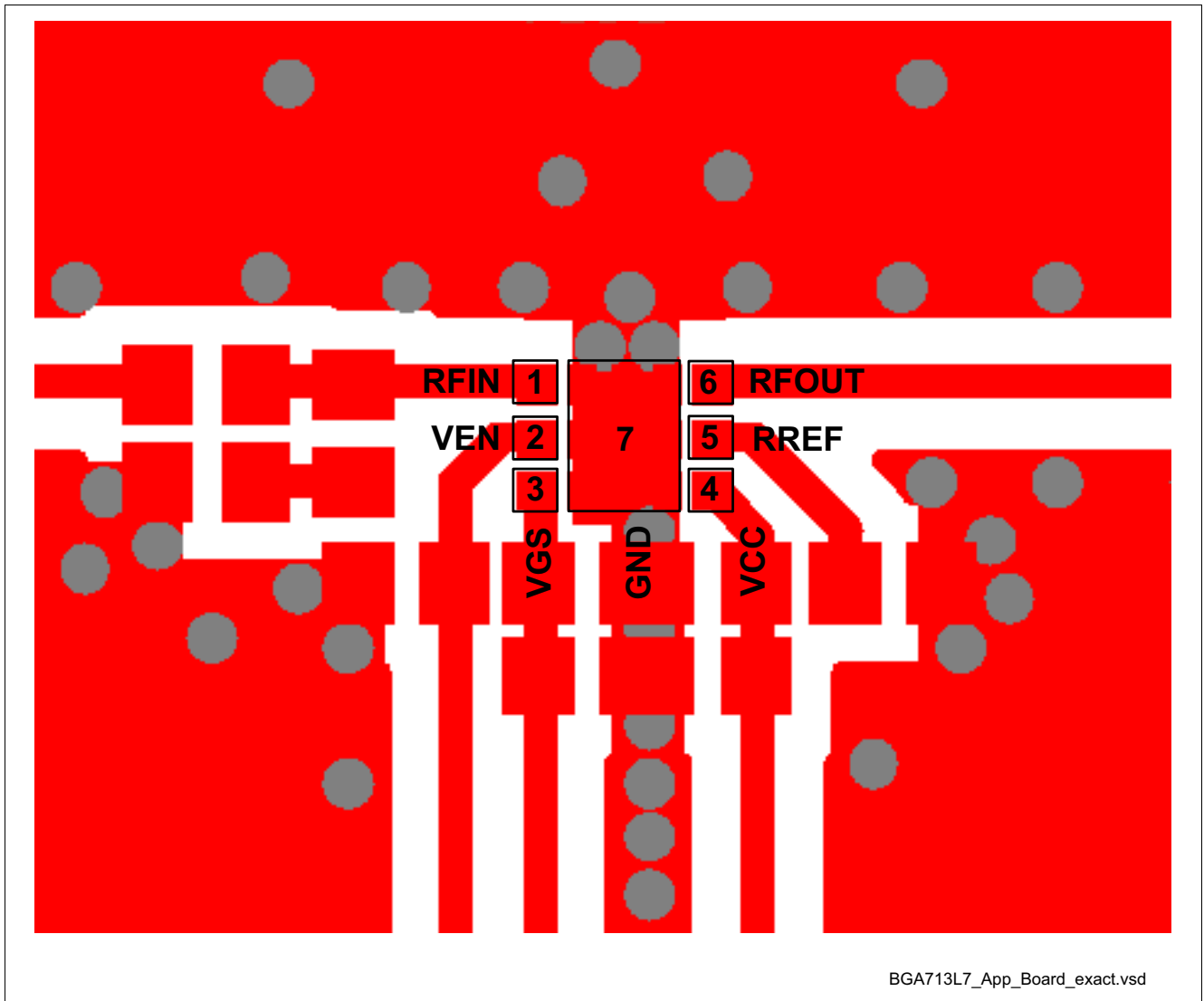

Figure 7 Detail of Application Board Layout

Note: In order to achieve the same performance as given in this datasheet please follow the suggested PCB-layout as closely as possible. The position of the GND vias is critical for RF performance.

4 Physical Characteristics

4.1 Package Footprint

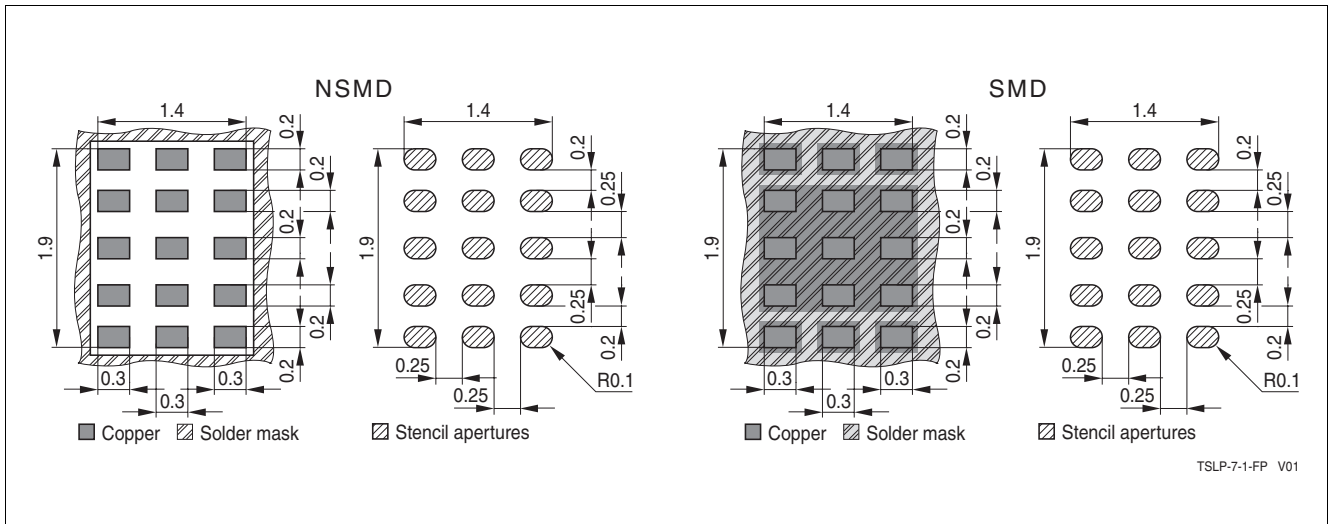

Figure 8 Recommended Footprint and Stencil Layout for the TSLP-7-1 Package

4.2 Package Dimensions

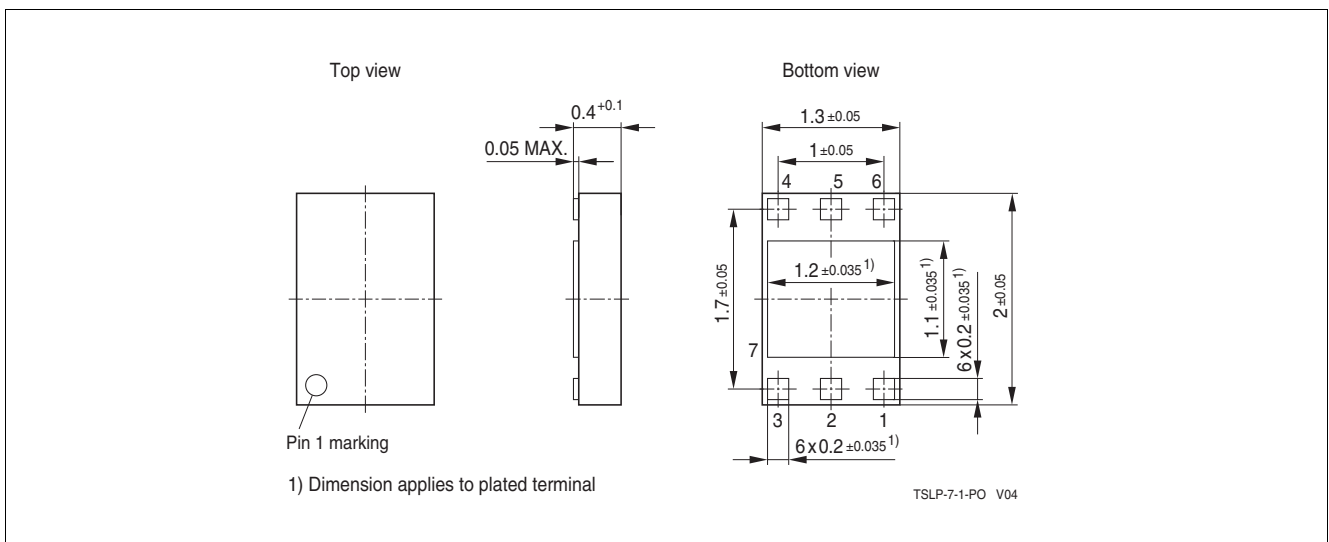

Figure 9 Package Outline (top, side and bottom view)

4.3 Product Marking Pattern

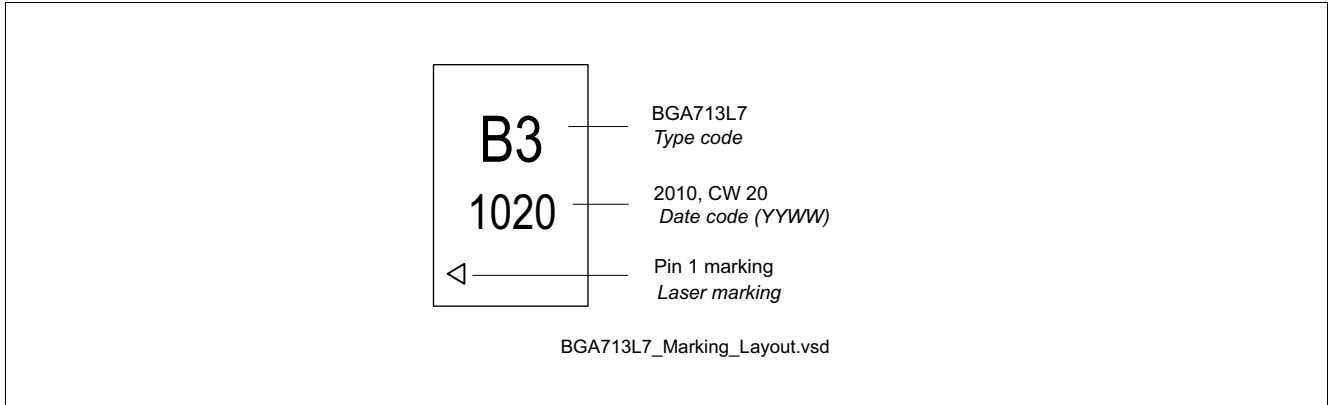

Figure 10 Marking Pattern (top view)

www.infineon.com

Published by Infineon Technologies AG