

C0603CH1H4R7C030BA

TDK Item Description : C0603CH1H4R7CT****



Application & Main Feature

Commercial Grade (General (Up to 50V))

Series

C0603 [EIA CC0201]

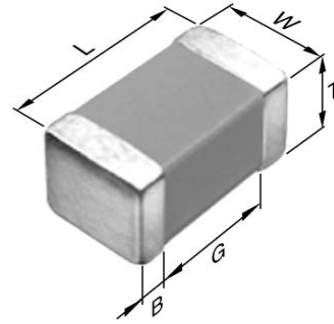

Dimensions

L 0.60mm +/-0.03mm
 W 0.30mm +/-0.03mm
 T 0.30mm +/-0.03mm
 B 0.10mm Min.
 G 0.20mm Min.

Temperature Characteristic

CH (-25 to 85 degC 0+/-60ppm/degC)

Rated Voltage

1H (50Vdc)

Capacitance

4.7pF

Capacitance Tolerance

C (+/-0.25pF)

Q Factor

494 Min.

Insulation Resistance

10Gohm Min.

AEC-Q200

Not Applicable

|Z|, ESR vs. Freq. Characteristics

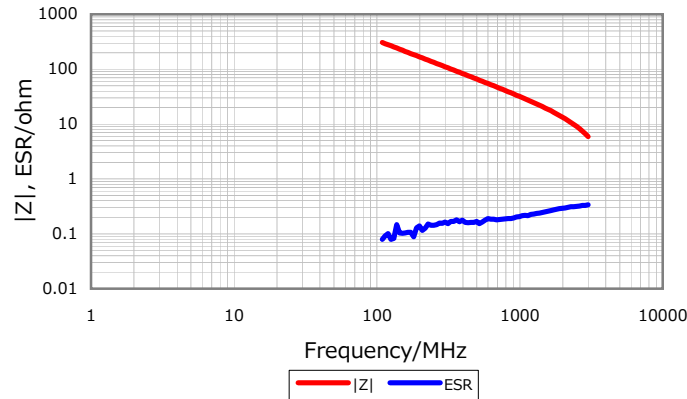

DC Bias Characteristic



Cap. vs. Freq. Characteristic

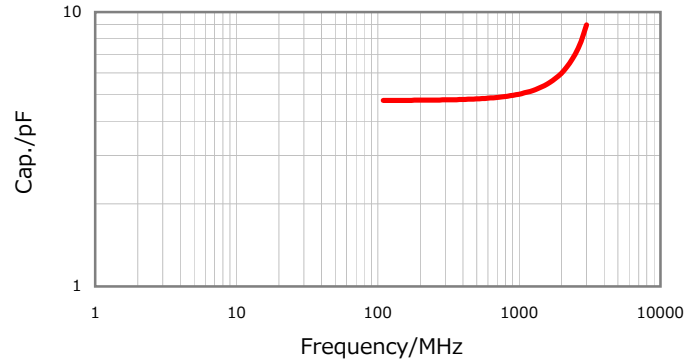

Temperature Characteristics

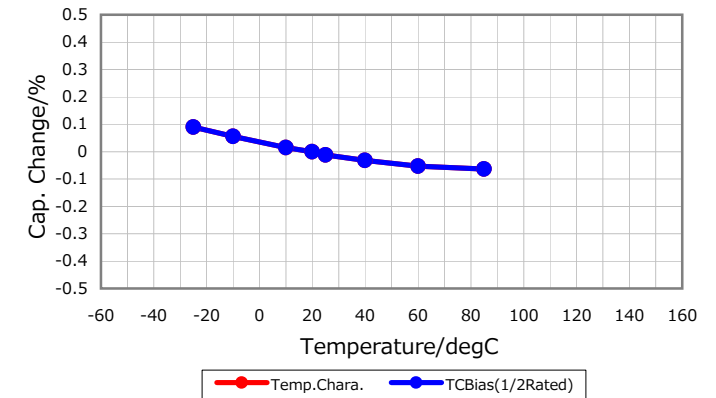

Characterization Sheet (Multilayer Ceramic Chip Capacitors)



All specifications are subject to change without notice.

January 2, 2016