

CATIA V5

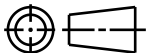

Revision Level			Revision Record	Changed	Date	Approved	Date
Drawing	State	Part					
04.1	Design Release	D	SEE ECN# 012734	KVH	7/9/14	SJA	7/9/14

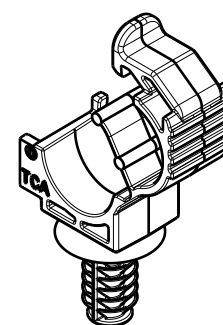
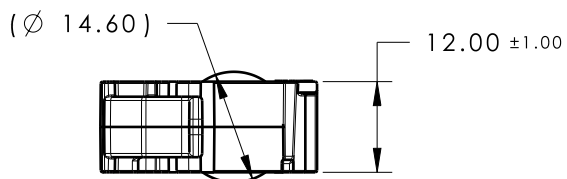

ISOMETRIC VIEW  
OPEN POSITION

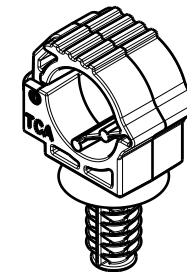

ISOMETRIC VIEW  
CLOSED POSITION

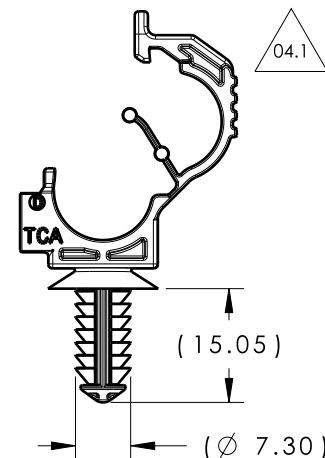
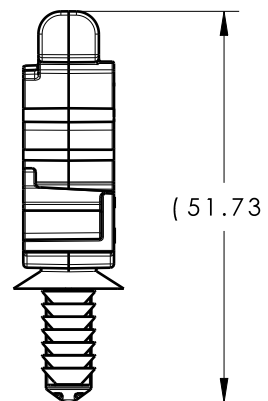
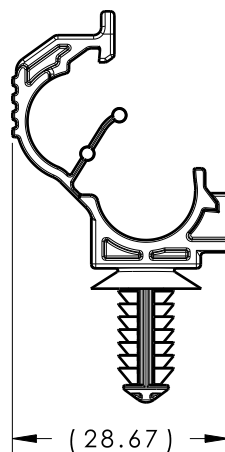

- REFERENCE:  
PERFORMANCE REQUIREMENTS AT DRY AS MOLDED:
1. FIR TREE PUSH IN FORCE: 45 NEWTONS (10 LBS) MAX IN THE APPLICABLE NOMINAL HOLE SIZE AND A PLATE THICKNESS OF 1.8mm.
  2. FIR TREE PULL OUT FORCE: 110 NEWTONS (25 LBS) MIN IN THE APPLICABLE NOMINAL HOLE SIZE AND A PLATE THICKNESS OF 1.8mm.
  3. SHEET METAL THICKNESS RANGE: 0.60mm - 8.25mm
  4. APPLICABLE HOLE SIZE:
    - A.  $\text{Ø}6.5\text{mm} \pm 0.4$
    - B.  $6.35\text{mm} \pm 0.25$  HEX

Material PA66HIRHS COLOR: BLACK	Units	millimeters	The copyright of this drawing is reserved by HellermannTyton. It is issued on condition that it is not reproduced, copied or disclosed to a third party, either wholly or in part, without the consent of HellermannTyton.	Drawn	KVH	9/28/12	Article/Type-No LOC5-9FT6LG	Scale	1:1	
	Tolerance defined on each dimension	Approved		SJA	4/1/13	Title LOCKING OMEGA CLIP (5 TO 9mm BUNDLE) WITH FIR TREE		Project Number	12-0430	
					Drawing-No		PRODUCTION : Phase	Format	AH	
								North America Email: corp@htamericas.com Web: www.hellermann.tyton.com		