

mikroC PRO for dsPIC™

Manual

mikroC PRO for dsPIC30/33 and PIC24 is a full-featured C compiler for dsPIC30, dsPIC33 and PIC24 MCUs from Microchip. It is designed for developing, building and debugging dsPIC30/33 and PIC24-based embedded applications. This development environment has a wide range of features such as: easy-to-use IDE, very compact and efficient code, many hardware and software libraries, comprehensive documentation, software simulator, COFF file generation, SSA optimization (up to 30% code reduction) and many more. Numerous ready-to-use and well-explained examples will give a good start for your embedded project.

Compiler

 **MikroElektronika**

SOFTWARE AND HARDWARE SOLUTIONS FOR EMBEDDED WORLD ...making it simple

Table of Contents

CHAPTER 1	32
INTRODUCTION	32
Introduction to mikroC PRO for dsPIC30/33 and PIC24	33
Features	33
Where to Start	33
What's new in mikroC PRO for dsPIC30/33 and PIC24	34
Compiler Changes	34
IDE Changes	34
Software License Agreement	35
mikroElektronika Associates License Statement and Limited Warranty	35
IMPORTANT - READ CAREFULLY	35
LIMITED WARRANTY	35
HIGH RISK ACTIVITIES	36
GENERAL PROVISIONS	36
Technical Support	37
How to Register	37
Who Gets the License Key	37
How to Get License Key	37
After Receiving the License Key	39
CHAPTER 2	41
mikroC PRO for dsPIC30/33 and PIC24 Environment	41
Main Menu Options	42
File	43
File Menu Options	43
Edit	44
Edit Menu Options	44
Find Text	45
Replace Text	45
Find In Files	46
Go To Line	46
Regular expressions option	46
View	47
View Menu Options	47
Project	49
Project Menu Options	49
Build	50
Build Menu Options	50
Run	51
Run Menu Options	51
Tools	52
Tools Menu Options	52

Help	53
Help Menu Options	53
mikroC PRO for dsPIC30/33 and PIC24 IDE	54
IDE Overview	54
Code Editor	55
Editor Settings	55
Auto Save	56
Highlighter	56
Spelling	56
Comment Style	56
Code Folding	56
Code Assistant	57
Parameter Assistant	57
Bookmarks	57
Go to Line	57
Column Select Mode	58
Editor Colors	58
Auto Correct	59
Auto Complete (Code Templates)	60
Code Explorer	62
Routine List	63
Project Manager	63
Project Settings	65
Library Manager	66
Managing libraries using Package Manager	67
Statistics	68
Memory Usage Windows	68
RAM Memory Usage	69
Used RAM Locations	69
SFR Locations	70
ROM Memory Usage	70
ROM Memory Constants	71
Functions	71
Functions Sorted By Name Chart	72
Functions Sorted By Size Chart	72
Functions Sorted By Addresses	73
Function Tree	73
Memory Summary	74
Messages Window	75
Quick Converter	76
Macro Editor	76
Image Preview	77
Toolbars	79
File Toolbar	80
Edit Toolbar	80

Advanced Edit Toolbar	81
Find/Replace Toolbar	81
Project Toolbar	82
Build Toolbar	82
Debug Toolbar	83
Styles Toolbar	83
Tools Toolbar	84
View Toolbar	84
Layout Toolbar	85
Help Toolbar	85
Customizing IDE Layout	86
Docking Windows	86
Saving Layout	87
Auto Hide	87
Options	88
Code editor	88
Tools	88
Output settings	89
Integrated Tools	91
Active Comments Editor	91
ASCII Chart	92
EEPROM Editor	93
Filter Designer	93
Graphic Lcd Bitmap Editor	94
HID Terminal	95
Lcd Custom Character	96
Seven Segment Editor	97
UDP Terminal	97
USART Terminal	98
Active Comments	99
New Active Comment	99
Renaming Active Comment	106
Deleting Active Comment	107
Export Project	108
Jump To Interrupt	109
Regular Expressions	110
Introduction	110
Simple matches	110
Escape sequences	110
Character classes	110
Metacharacters	111
Metacharacters - Line separators	111
Metacharacters - Predefined classes	112
Metacharacters - Word boundaries	112
Metacharacters - Iterators	112
Metacharacters - Alternatives	113

Metacharacters - Subexpressions	113
Metacharacters - Backreferences	113
Keyboard Shortcuts	114
CHAPTER 3	116
mikroC PRO for dsPIC30/33 and PIC24 Command Line Options	116
CHAPTER 4	118
mikroICD (In-Circuit Debugger)	118
Introduction	118
mikroICD Debugger Options	120
Debugger Options	120
mikroICD Debugger Example	121
mikroICD Debugger Windows	125
Debug Windows	125
Breakpoints Window	125
Watch Values Window	125
RAM Window	127
Stopwatch Window	127
EEPROM Watch Window	128
Code Watch Window	129
CHAPTER 5	130
Software Simulator Overview	130
Software Simulator	131
Software Simulator Debug Windows	132
Debug Windows	132
Breakpoints Window	132
Watch Values Window	132
RAM Window	134
Stopwatch Window	134
EEPROM Watch Window	135
Code Watch Window	136
Software Simulator Debugger Options	137
Debugger Options	137
CHAPTER 6	138
mikroC PRO for dsPIC30/33 and PIC24 Specifics	138
GOTO Table	139
ANSI Standard Issues	140
Divergence from the ANSI C Standard	140
C Language Extensions	140
Implementation-defined Behavior	140
Predefined Globals and Constants	141
Predefined project level defines	141
Accessing Individual Bits	142
sbit type	143

at keyword	144
bit type	144
Interrupts	145
Function Calls from Interrupt	145
Disable Context Saving	145
Interrupt Handling	145
Interrupt Example	146
Linker Directives	147
Directive absolute	147
Directive orgall	147
Directive funcorg	148
Indirect Function Calls	148
Built-in Routines	149
Lo	150
Hi	150
Higher	151
Highest	151
LoWord	152
HiWord	152
Delay_us	153
Delay_ms	153
Vdelay_ms	153
VDelay_Advanced_ms	154
Delay_Cyc	154
Delay_Cyc_Long	154
Clock_kHz	155
Clock_Mhz	155
Get_Fosc_kHz	155
Get_Fosc_Per_Cyc	156
Code Optimization	157
Constant folding	157
Constant propagation	157
Copy propagation	157
Value numbering	157
"Dead code" elimination	157
Stack allocation	157
Local vars optimization	157
Better code generation and local optimization	157
Single Static Assignment Optimization	158
Introduction	158
Proper Coding Recommendations	159
Asm code and SSA optimization	160
Debugging Notes	160
Warning Messages Enhancement	160
Common Object File Format (COFF)	161
COFF File Format	161

COFF File Generation	161
CHAPTER 7	163
dsPIC30/33 and PIC24 Specifics	163
Types Efficiency	164
Nested Calls Limitations	164
Limits of Indirect Approach Through PSV	164
Limits of Pointer to Function	164
Variable, constant and routine alignment	164
dsPIC Memory Organization	165
Program Memory (ROM)	165
Data Memory (RAM)	166
SFR Memory Space	166
X and Y Data RAM	166
DMA RAM	167
Unimplemented Memory Space	167
Memory Type Specifiers	168
code	168
data	168
rx	168
sfr	168
xdata	169
ydata	169
dma	169
Memory Type Qualifiers	170
Near Memory Qualifier	170
Far Memory Qualifier	170
Read Modify Write Problem	171
CHAPTER 8	175
mikroC PRO for dsPIC30/33 and PIC24 Language Reference	175
Lexical Elements Overview	178
Whitespace	179
Whitespace in Strings	179
Line Splicing with Backslash (\)	179
Comments	180
C comments	180
C++ comments	180
Nested comments	180
Tokens	181
Token Extraction Example	181
Constants	182
Integer Constants	182
Long and Unsigned Suffixes	182
Decimal	182
Hexadecimal	183

Binary	183
Octal	183
Floating Point Constants	184
Character Constants	184
Escape Sequences	184
Disambiguation	185
String Constants	186
Line Continuation with Backslash	186
Enumeration Constants	187
Pointer Constants	187
Constant Expressions	188
Keywords	189
Identifiers	190
Case Sensitivity	190
Uniqueness and Scope	191
Identifier Examples	191
Punctuators	191
Brackets	191
Parentheses	192
Braces	192
Comma	192
Semicolon	193
Colon	193
Asterisk (Pointer Declaration)	193
Equal Sign	194
Pound Sign (Preprocessor Directive)	194
Concepts	195
Objects	195
Objects and Declarations	195
Lvalues	196
Rvalues	196
Scope and Visibility	196
Scope	196
Visibility	196
Name Spaces	197
Duration	198
Static Duration	198
Local Duration	198
Types	199
Type Categories	199
Fundamental Types	200
Arithmetic Types	200
Integral Types	200
Floating-point Types	201

Enumerations	201
Enumeration Declaration	201
Anonymous Enum Type	202
Enumeration Scope	202
Void Type	203
Void Functions	203
Generic Pointers	203
Derived Types	203
Arrays	204
Array Declaration	204
Array Initialization	204
Arrays in Expressions	205
Multi-dimensional Arrays	205
Pointers	206
Pointer Declarations	206
Null Pointers	207
Assign an address to a Function Pointer	207
Function Pointers	209
Assign an address to a Function Pointer	209
Pointer Arithmetic	210
Arrays and Pointers	210
Assignment and Comparison	211
Pointer Addition	212
Pointer Subtraction	213
Structures	213
Structure Declaration and Initialization	213
Incomplete Declarations	214
Untagged Structures and Typedefs	215
Anonymous Structures	215
Working with Structures	216
Assignment	216
Size of Structure	216
Structures and Functions	216
Structure Member Access	217
Accessing Nested Structures	218
Structure Uniqueness	218
Unions	219
Union Declaration	219
Size of Union	219
Union Member Access	219
Anonymous Unions	220
Anonymous Union Member Access	220
Bit Fields	221
Bit Fields Declaration	221
Bit Fields Access	222

Types Conversions	222
Standard Conversions	223
Arithmetic Conversions	223
Pointer Conversions	224
Explicit Types Conversions (Typecasting)	224
Declarations	225
Declarations and Definitions	225
Declarations and Declarators	226
Linkage	226
Linkage Rules	227
Internal Linkage Rules	227
Storage Classes	227
Auto	228
Register	228
Static	228
Extern	228
Type Qualifiers	229
Qualifier const	229
Qualifier volatile	229
Typedef Specifier	229
asm Declaration	230
Accessing variables	230
Asm code and SSA optimization	231
Initialization	232
Automatic Initialization	232
Functions	233
Function Declaration	233
Function Prototypes	234
Function Definition	234
Functions reentrancy	235
Function Calls and Argument Conversions	235
Function Calls	235
Argument Conversions	236
Ellipsis ('...') Operator	237
Operators	238
Operators Precedence and Associativity	239
Binary Arithmetic Operators	240
Unary Arithmetic Operators	240
Relational Operators	241
Relational Operators Overview	241
Relational Operators in Expressions	241
Bitwise Operators	242
Bitwise Operators Overview	242
Logical Operations on Bit Level	242

Bitwise Shift Operators	243
Bitwise vs. Logical	243
Logical Operators	244
Logical Operators Overview	244
Logical Operations	244
Logical Expressions and Side Effects	244
Logical vs. Bitwise	245
Conditional Operator ? :	245
Conditional Operator Rules	245
Assignment Operators	246
Simple Assignment Operator	246
Compound Assignment Operators	246
Assignment Rules	246
Unary Operators	247
Unary Arithmetic Operators	247
Unary Logical Operator	248
Unary Bitwise Operator	248
Address and Indirection Operator	248
Sizeof Operator	249
Sizeof Applied to Expression	249
Sizeof Applied to Type	249
Expressions	250
Comma Expressions	250
Statements	251
Labeled Statements	251
Expression Statements	252
Selection Statements	252
If Statement	252
Nested If statements	252
Switch Statement	253
Nested switch	254
Iteration Statements (Loops)	254
While Statement	254
Do Statement	254
For Statement	255
Jump Statements	256
Break and Continue Statements	256
Break Statement	256
Continue Statement	256
Goto Statement	257
Return Statement	257
Compound Statements (Blocks)	258
Preprocessor	258

Preprocessor Directives	258
Line Continuation with Backslash (\)	259
Macros	259
Defining Macros and Macro Expansions	259
Macros with Parameters	260
Undefining Macros	261
File Inclusion	261
Explicit Path	262
Preprocessor Operators	263
Operator #	263
Operator ##	263
Conditional Compilation	264
Directives #if, #elif, #else, and #endif	264
Directives #ifdef and #ifndef	265
CHAPTER 9	266
mikoC PRO for dsPIC30/33 and PIC24 Libraries	266
Hardware Libraries	267
Digital Signal Processing Libraries	267
Standard ANSI C Libraries	268
Miscellaneous Libraries	268
Hardware Libraries	269
ADC Library	269
Library Routines	270
ADCx_Init	270
ADCx_Init_Advanced	271
ADCx_Get_Sample	272
ADCx_Read	272
ADC_Set_Active	273
Library Example	273
CAN Library	275
Library Routines	275
CANxSetOperationMode	276
CANxGetOperationMode	276
CANxInitialize	277
CANxSetBaudRate	278
CANxSetMask	279
CANxSetFilter	280
CANxRead	281
CANxWrite	282
CAN Constants	283
CAN_OP_MODE Constants	283
CAN_CONFIG_FLAGS Constants	283
CAN_TX_MSG_FLAGS Constants	284
CAN_RX_MSG_FLAGS Constants	285

CAN_MASK Constants	285
CAN_FILTER Constants	286
Library Example	286
HW Connection	289
CANSPI Library	290
Library Dependency Tree	290
External dependencies of CANSPI Library	290
Library Routines	291
CANSPISetOperationMode	291
CANSPIGetOperationMode	292
CANSPIInitialize	292
CANSPISetBaudRate	294
CANSPISetMask	295
CANSPISetFilter	296
CANSPIRead	297
CANSPIWrite	298
CANSPI Constants	298
CANSPI_OP_MODE Constants	298
CANSPI_TX_MSG_FLAGS Constants	300
CANSPI_RX_MSG_FLAGS Constants	300
CANSPI_MASK Constants	301
CANSPI_FILTER Constants	301
Library Example	302
HW Connection	305
Compact Flash Library	306
Library Dependency Tree	306
External dependencies of Compact Flash Library	307
Library Routines	308
Cf_Init	309
Cf_Detect	310
Cf_Enable	310
Cf_Disable	310
Cf_Read_Init	311
Cf_Read_Byte	311
Cf_Write_Init	311
Cf_Write_Byte	312
Cf_Read_Sector	312
Cf_Write_Sector	312
Cf_Fat_Init	313
Cf_Fat_QuickFormat	313
Cf_Fat_Assign	314
Cf_Fat_Reset	315
Cf_Fat_Read	315
Cf_Fat_Rewrite	316
Cf_Fat_Append	316
Cf_Fat_Delete	316
Cf_Fat_Write	317

Cf_Fat_Set_File_Date	317
Cf_Fat_Get_File_Date	318
Cf_Fat_Get_File_Date_Modified	318
Cf_Fat_Get_File_Size	319
Cf_Fat_Get_Swap_File	319
Library Example	321
HW Connection	323
ECAN Library	324
Library Routines	324
ECANxDmaChannelInit	325
ECANxSetOperationMode	325
ECANxGetOperationMode	326
ECANxInitialize	327
ECANxSelectTxBuffers	328
ECANxFilterDisable	328
ECANxFilterEnable	329
ECANxSetBufferSize	329
ECANxSetBaudRate	330
ECANxSetMask	331
ECANxSetFilter	332
ECANxRead	333
ECANxWrite	334
ECAN Constants	335
ECAN_OP_MODE Constants	335
ECAN_CONFIG_FLAGS Constants	335
ECAN_TX_MSG_FLAGS Constants	336
ECAN_RX_MSG_FLAGS Constants	336
ECAN_MASK Constants	337
ECAN_FILTER Constants	337
ECAN_RX_BUFFER Constants	338
Library Example	339
HW Connection	343
EEPROM Library	343
Library Routines	343
EEPROM_Erase	344
EEPROM_Erase_Block	344
EEPROM_Read	344
EEPROM_Write	345
EEPROM_Write_Block	345
Library Example	345
Epson S1D13700 Graphic Lcd Library	347
External dependencies of the Epson S1D13700 Graphic Lcd Library	347
Library Routines	348
S1D13700_Init	349
S1D13700_Write_Command	350
S1D13700_Write_Parameter	351
S1D13700_Read_Parameter	351

S1D13700_Fill	351
S1D13700_GrFill	352
S1D13700_TxtFill	352
S1D13700_Display_GrLayer	352
S1D13700_Display_TxtLayer	353
S1D13700_Set_Cursor	353
S1D13700_Display_Cursor	354
S1D13700_Write_Char	354
S1D13700_Write_Text	355
S1D13700_Dot	355
S1D13700_Line	356
S1D13700_H_Line	356
S1D13700_V_Line	357
S1D13700_Rectangle	357
S1D13700_Box	358
S1D13700_Rectangle_Round_Edges	358
S1D13700_Rectangle_Round_Edges_Fill	359
S1D13700_Circle	359
S1D13700_Circle_Fill	360
S1D13700_Image	360
S1D13700_PartialImage	361
Flash Memory Library	362
dsPIC30:	362
PIC24 and dsPIC33:	362
24F04KA201 and 24F16KA102 Family Specifics :	363
Library Routines	363
dsPIC30 Functions	363
PIC24 and dsPIC33 Functions	363
dsPIC30 Functions	363
FLASH_Erase32	364
FLASH_Write_Block	364
FLASH_Write_Compact	365
FLASH_Write_Init	365
FLASH_Write_Loadlatch4	366
FLASH_Write_Loadlatch4_Compact	367
FLASH_Write_DoWrite	368
FLASH_Read4	368
FLASH_Read4_Compact	369
PIC24 and dsPIC33 Functions	369
FLASH_Erase	369
FLASH_Write	370
FLASH_Write_Compact	370
FLASH_Read	371
FLASH_Read_Compact	371
Library Example	372
Graphic Lcd Library	373
Library Dependency Tree	373

External dependencies of Graphic Lcd Library	374
Glcd_Init	375
Glcd_Set_Side	377
Glcd_Set_X	377
Glcd_Set_Page	377
Glcd_Read_Data	378
Glcd_Write_Data	378
Glcd_Fill	379
Glcd_Dot	379
Glcd_Line	379
Glcd_V_Line	380
Glcd_H_Line	380
Glcd_Rectangle	381
Glcd_Rectangle_Round_Edges	381
Glcd_Rectangle_Round_Edges_Fill	382
Glcd_Box	382
Glcd_Circle	383
Glcd_Circle_Fill	383
Glcd_Set_Font	384
Glcd_Write_Char	385
Glcd_Write_Text	385
Glcd_Image	386
Glcd_PartialImage	386
Library Example	387
HW Connection	389
I²C Library	390
Library Routines	390
I2Cx_Init	390
I2Cx_Start	391
I2Cx_Restart	391
I2Cx_Is_Idle	392
I2Cx_Read	392
I2Cx_Write	393
I2Cx_Stop	393
Library Example	394
HW Connection	394
Keypad Library	395
External dependencies of Keypad Library	395
Library Routines	395
Keypad_Init	395
Keypad_Key_Press	396
Keypad_Key_Click	396
Library Example	397
HW Connection	398
Lcd Library	399
Library Dependency Tree	399
Keypad_Key_Click	399

Library Routines	399
Lcd_Init	400
Lcd_Out	401
Lcd_Out_Cp	401
Lcd_Chr	401
Lcd_Chr_Cp	402
Lcd_Cmd	402
Available Lcd Commands	402
Library Example	403
Manchester Code Library	405
Keypad_Key_Click	405
Library Routines	406
Man_Receive_Init	406
Man_Receive	407
Man_Send_Init	407
Man_Send	408
Man_Synchro	408
Man_Break	409
Library Example	410
Connection Example	412
Multi Media Card Library	413
Secure Digital Card	413
Secure Digital High Capacity Card	413
Library Dependency Tree	414
External dependencies of MMC Library	414
Library Routines	414
Mmc_Init	415
Mmc_Read_Sector	416
Mmc_Write_Sector	416
Mmc_Read_Cid	417
Mmc_Read_Csd	417
Mmc_Fat_Init	418
Mmc_Fat_QuickFormat	419
Mmc_Fat_Assign	420
Mmc_Fat_Reset	421
Mmc_Fat_Read	421
Mmc_Fat_Rewrite	422
Mmc_Fat_Append	422
Mmc_Fat_Delete	422
Mmc_Fat_Write	423
Mmc_Fat_Set_File_Date	423
Mmc_Fat_Get_File_Date	424
Mmc_Fat_Get_File_Date_Modified	425
Mmc_Fat_Get_File_Size	425
Mmc_Fat_Get_Swap_File	426
Library Example	427
HW Connection	431

OneWire Library	432
Library Routines	432
Ow_Reset	432
Ow_Read	433
Ow_Write	433
Library Example	434
HW Connection	436
Peripheral Pin Select Library	437
Library Routines	437
Unlock_IOLOCK	437
Lock_IOLOCK	437
PPS_Mapping	438
Direction Parameters	438
Input Functions	438
Output Functions	439
Port Expander Library	441
Library Dependency Tree	441
External dependencies of Port Expander Library	441
Library Routines	441
Expander_Init	442
Expander_Init_Advanced	443
Expander_Read_Byte	444
Expander_Write_Byte	444
Expander_Read_PortA	444
Expander_Read_PortB	445
Expander_Read_PortAB	445
Expander_Write_PortA	446
Expander_Write_PortB	446
Expander_Write_PortAB	447
Expander_Set_DirectionPortA	447
Expander_Set_DirectionPortB	448
Expander_Set_DirectionPortAB	448
Expander_Set_PullUpsPortA	448
Expander_Set_PullUpsPortB	449
Expander_Set_PullUpsPortAB	449
HW Connection	451
PS/2 Library	452
External dependencies of PS/2 Library	452
Library Routines	452
Ps2_Config	453
Ps2_Key_Read	453
Special Function Keys	454
Library Example	455
HW Connection	456
PWM Library	456
Library Routines	456

PWM_Init	457
PWM_Set_Duty	457
PWM_Start	458
PWM_Stop	458
Library Example	458
HW Connection	460
PWM Motor Control Library	460
Library Routines	460
PWMx_Mc_Init	461
PWMx_Mc_Set_Duty	462
PWMx_Mc_Start	462
PWMx_Mc_Stop	463
HW Connection	464
RS-485 Library	464
Library Dependency Tree	465
External dependencies of RS-485 Library	465
Library Routines	465
RS485Master_Init	465
RS485Master_Receive	466
RS485Master_Send	466
RS485Slave_Init	467
RS485Slave_Receive	468
RS485Slave_Send	468
Library Example	469
HW Connection	472
Message format and CRC calculations	473
Software I²C Library	474
External dependencies of Software I ² C Library	474
Library Routines	474
Soft_I2C_Init	475
Soft_I2C_Start	475
Soft_I2C_Read	476
Soft_I2C_Write	476
Soft_I2C_Stop	477
Soft_I2C_Break	478
Library Example	479
Software SPI Library	481
External dependencies of Software SPI Library	481
Library Routines	481
Soft_SPI_Init	482
Soft_SPI_Read	483
Soft_SPI_Write	483
Library Example	483
Software UART Library	485
Library Routines	485
Soft_UART_Init	485

Soft_UART_Read	486
Soft_UART_Write	486
Soft_UART_Break	487
Library Example	488
Sound Library	489
Library Routines	489
Sound_Init	489
Sound_Play	489
HW Connection	491
SPI Library	492
Library Routines	492
SPIx_Init	493
SPIx_Init_Advanced	494
SPIx_Read	496
SPIx_Write	496
SPI_Set_Active	497
Library Example	497
HW Connection	498
SPI Ethernet Library	499
Library Dependency Tree	499
External dependencies of SPI Ethernet Library	500
Library Routines	501
SPIx_Write	501
SPIx_Write	502
SPI_Ethernet_Enable	503
SPI_Ethernet_Disable	504
SPI_Ethernet_doPacket	505
SPI_Ethernet_putByte	505
SPI_Ethernet_putBytes	506
SPI_Ethernet_putConstBytes	506
SPI_Ethernet_putString	506
SPI_Ethernet_putConstString	507
SPI_Ethernet_getByte	507
SPI_Ethernet_getBytes	507
SPI_Ethernet_UserTCP	508
SPI_Ethernet_UserUDP	509
SPI_Ethernet_getIpAddress	510
SPI_Ethernet_getDnsIpAddress	510
SPI_Ethernet_getIpMask	510
SPI_Ethernet_confNetwork	511
SPI_Ethernet_arpResolve	511
SPI_Ethernet_sendUDP	512
SPI_Ethernet_dnsResolve	512
SPI_Ethernet_initDHCP	513
SPI_Ethernet_doDHCPLeaseTime	514
SPI_Ethernet_renewDHCP	514
Library Example	515

HW Connection	522
SPI Ethernet ENC24J600 Library	523
Library Dependency Tree	523
External dependencies of SPI Ethernet ENC24J600 Library	524
Library Routines	525
SPI_Ethernet_24j600_Init	526
SPI_Ethernet_24j600_Enable	528
SPI_Ethernet_24j600_Disable	529
SPI_Ethernet_24j600_doPacket	530
SPI_Ethernet_24j600_putByte	530
SPI_Ethernet_24j600_putBytes	531
SPI_Ethernet_24j600_putConstBytes	531
SPI_Ethernet_24j600_putString	532
SPI_Ethernet_24j600_putConstString	532
SPI_Ethernet_24j600_getByte	532
SPI_Ethernet_24j600_getBytes	533
SPI_Ethernet_24j600_UserTCP	533
SPI_Ethernet_24j600_UserUDP	534
SPI_Ethernet_24j600_getIpAddress	534
SPI_Ethernet_24j600_getGwIpAddress	535
SPI_Ethernet_24j600_getDnsIpAddress	535
SPI_Ethernet_24j600_getIpMask	536
SPI_Ethernet_24j600_confNetwork	536
SPI_Ethernet_24j600_arpResolve	537
SPI_Ethernet_24j600_sendUDP	537
SPI_Ethernet_24j600_dnsResolve	538
SPI_Ethernet_24j600_initDHCP	539
SPI_Ethernet_24j600_doDHCPLeaseTime	540
SPI_Ethernet_24j600_renewDHCP	540
Library Example	540
SPI Graphic Lcd Library	541
Library Dependency Tree	541
External dependencies of SPI Lcd Library	541
Library Routines	541
SPI_Glcd_Init	542
SPI_Glcd_Set_Side	543
SPI_Glcd_Set_Page	543
SPI_Glcd_Set_X	543
SPI_Glcd_Read_Data	544
SPI_Glcd_Write_Data	544
SPI_Glcd_Fill	545
SPI_Glcd_Dot	545
SPI_Glcd_Line	546
SPI_Glcd_V_Line	546
SPI_Glcd_H_Line	547
SPI_Glcd_Rectangle	547
SPI_Glcd_Rectangle_Round_Edges	548

SPI_Glcd_Rectangle_Round_Edges_Fill	548
SPI_Glcd_Box	549
SPI_Glcd_Circle	549
SPI_Glcd_Circle_Fill	550
SPI_Glcd_Set_Font	551
SPI_Glcd_Write_Char	552
SPI_Glcd_Write_Text	552
SPI_Glcd_Image	553
SPI_Glcd_PartialImage	553
Library Example	554
HW Connection	556
SPI Lcd Library	557
Library Dependency Tree	557
External dependencies of SPI Lcd Library	557
Library Routines	557
SPI_Lcd_Config	558
SPI_Lcd_Out	558
SPI_Lcd_Out_Cp	559
SPI_Lcd_Chr	559
SPI_Lcd_Chr_Cp	559
SPI_Lcd_Cmd	560
SPI_Lcd_Cmd	560
Library Example	561
Default Pin Configuration	561
SPI Lcd8 (8-bit interface) Library	563
Library Dependency Tree	563
External dependencies of SPI Lcd Library	563
Library Routines	563
SPI_Lcd8_Config	564
SPI_Lcd8_Out	565
SPI_Lcd8_Out_Cp	565
SPI_Lcd8_Chr	565
SPI_Lcd8_Chr_Cp	566
SPI_Lcd8_Cmd	566
Available SPI Lcd8 Commands	567
Library Example	567
SPI T6963C Graphic Lcd Library	570
Library Dependency Tree	570
External dependencies of SPI T6963C Graphic Lcd Library	570
Library Routines	571
SPI_Lcd8_Cmd	572
SPI_T6963C_writeData	573
SPI_T6963C_writeCommand	573
SPI_T6963C_setPtr	574
SPI_T6963C_waitReady	574
SPI_T6963C_fill	574
SPI_T6963C_dot	575

SPI_T6963C_write_char	575
SPI_T6963C_write_text	576
SPI_T6963C_line	577
SPI_T6963C_rectangle	577
SPI_T6963C_rectangle_round_edges	578
SPI_T6963C_rectangle_round_edges_fill	578
SPI_T6963C_box	579
SPI_T6963C_circle	579
SPI_T6963C_circle_fill	579
SPI_T6963C_image	580
SPI_T6963C_PartialImage	580
SPI_T6963C_sprite	581
SPI_T6963C_set_cursor	581
SPI_T6963C_clearBit	581
SPI_T6963C_setBit	582
SPI_T6963C_negBit	582
SPI_T6963C_displayGrPanel	582
SPI_T6963C_displayTxtPanel	583
SPI_T6963C_setGrPanel	583
SPI_T6963C_setTxtPanel	583
SPI_T6963C_panelFill	584
SPI_T6963C_grFill	584
SPI_T6963C_txtFill	584
SPI_T6963C_cursor_height	585
SPI_T6963C_graphics	585
SPI_T6963C_text	585
SPI_T6963C_cursor	586
SPI_T6963C_cursor_blink	586
Library Example	586
HW Connection	591
T6963C Graphic Lcd Library	592
Library Dependency Tree	592
Library Dependency Tree	593
Library Routines	594
SPI_T6963C_cursor	595
T6963C_writeData	596
T6963C_writeCommand	597
T6963C_setPtr	597
T6963C_waitReady	597
T6963C_fill	598
T6963C_dot	598
T6963C_write_char	599
T6963C_write_text	600
T6963C_line	600
T6963C_rectangle	601
T6963C_rectangle_round_edges	601
T6963C_rectangle_round_edges_fill	602

T6963C_box	602
T6963C_circle	602
T6963C_circle_fill	603
T6963C_image	603
T6963C_PartialImage	604
T6963C_sprite	604
T6963C_set_cursor	605
T6963C_clearBit	605
T6963C_setBit	605
T6963C_negBit	606
T6963C_displayGrPanel	606
T6963C_displayTxtPanel	606
T6963C_setGrPanel	607
T6963C_setTxtPanel	607
T6963C_panelFill	607
T6963C_grFill	608
T6963C_txtFill	608
T6963C_cursor_height	608
T6963C_graphics	609
T6963C_text	609
T6963C_cursor	609
T6963C_cursor_blink	610
Library Example	610
HW Connection	614
TFT Library	615
External dependencies of TFT Library	615
Library Routines	616
TFT_Init	617
TFT_Set_Index	618
TFT_Write_Command	618
TFT_Write_Data	618
TFT_Set_Active	619
TFT_Set_Font	620
TFT_Write_Char	621
TFT_Write_Text	621
TFT_Fill_Screen	622
TFT_Dot	623
TFT_Set_Pen	624
TFT_Set_Brush	625
TFT_Line	627
TFT_H_Line	628
TFT_V_Line	628
TFT_Rectangle_Round_Edges	629
TFT_Circle	629
TFT_Image	629
TFT_Partial_Image	630
TFT_Image_Jpeg	630

TFT_RGBToColor16bit	631
TFT_Color16bitToRGB	631
HW Connection	632
Touch Panel Library	633
Library Dependency Tree	633
External dependencies of Touch Panel Library	633
Library Routines	633
TP_Init	634
TP_Set_ADC_Threshold	634
TP_Press_Detect	635
TP_Get_Coordinates	636
TP_Calibrate_Bottom_Left	636
TP_Calibrate_Upper_Right	637
TP_Get_Calibration_Consts	637
TP_Set_Calibration_Consts	638
Library Example	638
Touch Panel TFT Library	643
Library Dependency Tree	643
External dependencies of Touch Panel TFT Library	643
Library Routines	643
TP_TFT_Init	644
TP_TFT_Set_ADC_Threshold	644
TP_TFT_Press_Detect	645
TP_TFT_Get_Coordinates	646
TP_TFT_Calibrate_Min	646
TP_TFT_Calibrate_Max	647
TP_TFT_Get_Calibration_Consts	647
TP_TFT_Set_Calibration_Consts	648
HW Connection	648
UART Library	649
Library Routines	649
UARTx_Init	650
UARTx_Init_Advanced	651
UARTx_Data_Ready	653
UARTx_Tx_Idle	654
UARTx_Read	655
UARTx_Read_Text	656
UARTx_Write	657
UARTx_Write_Text	658
UART_Set_Active	659
Library Example	660
HW Connection	661
USB Library	662
USB HID Class	662
Library Routines	662
HID_Enable	663

HID_Read	663
HID_Write	664
HID_Disable	664
USB_Interrupt_Proc	665
USB_Polling_Proc	665
Gen_Enable	666
Gen_Read	666
Gen_Write	667
Library Example	668
HW Connection	668
DSP Libraries	669
Digital Signal Processing Libraries	669
FIR Filter Library	670
Library Routines	670
FIR_Radix	670
IIR Filter Library	671
Library Routines	671
IIR_Radix	671
FFT Library	672
Library Dependency Tree	672
FFT	672
Twiddle Factors:	673
TwiddleCoeff_64	673
TwiddleCoeff_128	673
TwiddleCoeff_256	674
TwiddleCoeff_512	674
Bit Reverse Complex Library	676
Library Routines	676
BitReverseComplex	676
Vectors Library	677
Library Routines	677
Vector_Set	677
Vector_Power	678
Vector_Subtract	678
Vector_Scale	679
Vector_Negate	679
Vector_Multiply	680
Vector_Min	680
Vector_Max	681
Vector_Dot	681
Vector_Correlate	682
Vector_Convolve	683
Vector_Add	684
Matrices Library	685
Library Routines	685
Matrix_Transpose	685

Matrix_Subtract	686
Matrix_Scale	686
Matrix_Multiply	687
Matrix_Add	688
Standard ANSI C Libraries	689
ANSI C Ctype Library	689
Library Functions	689
isalnum	690
isalpha	690
iscntrl	690
isdigit	690
isgraph	691
islower	691
ispunct	691
isspace	691
isupper	692
isxdigit	692
toupper	692
tolower	692
ANSI C Math Library	693
Library Functions	693
acos	693
asin	694
atan	694
atan2	694
ceil	694
cos	695
cosh	695
exp	695
fabs	695
floor	695
frexp	696
ldexp	696
log	696
log10	696
modf	697
pow	697
sin	697
sinh	697
sqrt	698
tan	698
tanh	698
ANSI C Stdlib Library	699
Library Dependency Tree	699
Library Functions	699
abs	699

atof	700
atoi	700
atol	700
div	700
ldiv	701
uldiv	701
labs	701
max	701
min	702
rand	702
srand	702
xtoi	702
Div Structures	703
ANSI C String Library	704
Library Functions	704
memchr	704
memcmp	705
memcpy	705
memmove	705
memset	706
strcat	706
strchr	706
strcmp	707
strcpy	707
strlen	707
strncat	708
strncpy	708
strspn	708
strncmp	709
strstr	709
strcspn	710
strpbrk	710
strrchr	710
strtok	711
Miscellaneous Libraries	712
Button Library	712
Library Routines	712
strchr	712
Conversions Library	714
Library Dependency Tree	714
Library Routines	714
ByteToStr	715
ShortToStr	715
WordToStr	716
IntToStr	716
LongToStr	717

LongWordToStr	717
FloatToStr	718
WordToStrWithZeros	719
IntToStrWithZeros	719
LongWordToStrWithZeros	720
LongIntToStrWithZeros	720
ByteToHex	721
ShortToHex	721
WordToHex	722
IntToHex	722
LongWordToHex	723
LongIntToHex	723
Dec2Bcd	724
Bcd2Dec	724
Dec2Bcd16	725
Bcd2Dec16	725
Rtrim	726
Ltrim	726
PrintOut Library	727
Library Dependency Tree	727
Library Routines	727
PrintOut	727
Setjmp Library	731
Library Routines	731
Setjmp	731
Longjmp	732
Library Example	732
Sprintf Library	734
Library Dependency Tree	734
Functions	734
sprintf	734
sprintfi	736
sprintfi	736
Library Example	737
Time Library	738
Library Routines	738
Time_dateToEpoch	738
Time_epochToDate	739
Time_dateDiff	740
Library Example	741
Trigonometry Library	742
Library Routines	742
sinE3	742
cosE3	743
CHAPTER 10	744
Tutorials	744

Managing Project	744
Projects	744
New Project	745
New Project Wizard Steps	745
New Project	748
New Project Wizard Steps	748
Customizing Projects	752
Managing Project Group	752
Add/Remove Files from Project	752
Project Level Defines:	753
Add/Remove Files from Project	754
Project Level Defines:	755
Source Files	756
Managing Source Files	756
Creating new source file	756
Opening an existing file	756
Printing an open file	756
Saving file	756
Saving file under a different name	757
Closing file	757
Search Paths	757
Paths for Source Files (.c)	758
Paths for Header Files (.h)	758
Edit Project	759
Source Files	760
Managing Source Files	760
Creating new source file	760
Opening an existing file	760
Printing an open file	760
Saving file	760
Saving file under a different name	761
Closing file	761
Search Paths	761
Paths for Source Files (.c)	762
Paths for Header Files (.h)	762
Clean Project Folder	763
Compilation	764
Output Files	764
Assembly View	764
Multiple Library Versions	765
Using Microchip MPLAB® IDE with mikroElektronika compilers	766
Debugging Your Code	766
Using MPLAB® ICD 2 Debugger	766
Using MPLAB® Simulator	773

Frequently Asked Questions	778
Can I use your compilers and programmer on Windows Vista (Windows 7) ?	778
I am getting "Access is denied" error in Vista, how to solve this problem ?	778
What are differences between mikroC PRO, mikroPascal PRO and mikroBasic PRO compilers ?	
Why do they have different prices ?	778
Why do your PIC compilers don't support 12F508 and some similar chips ?	778
What are limitations of demo versions of mikroElektronika's compilers ?	778
Why do I still get demo limit error when I purchased and installed license key ?	778
I have bought license for the older version, do I have to pay license for the new version of the compiler ?	779
Do your compilers work on Windows Vista (Windows 7) ?	779
What does this function/procedure/routine do ?	779
I try to compile one of the provided examples and nothing happens, what is the problem?	779
Can I get your library sources ? I need to provide all sources with my project.	779
Can I use code I developed in your compilers in commercial purposes ? Are there some limitations ?	779
Why does an example provided with your compilers doesn't work ?	779
Your example works if I use the same MCU you did, but how to make it work for another MCU ?	779
I need this project finished, can you help me ?	780
Do you have some discount on your compilers/development systems for students/professors ?	780
I have a question about your compilers which is not listed here. Where can I find an answer ?	780

CHAPTER 1

INTRODUCTION

The mikroC PRO for dsPIC30/33 and PIC24 is a powerful, feature-rich development tool for dsPIC30/33 and PIC24 microcontrollers. It is designed to provide the programmer with the easiest possible solution to developing applications for embedded systems, without compromising performance or control.

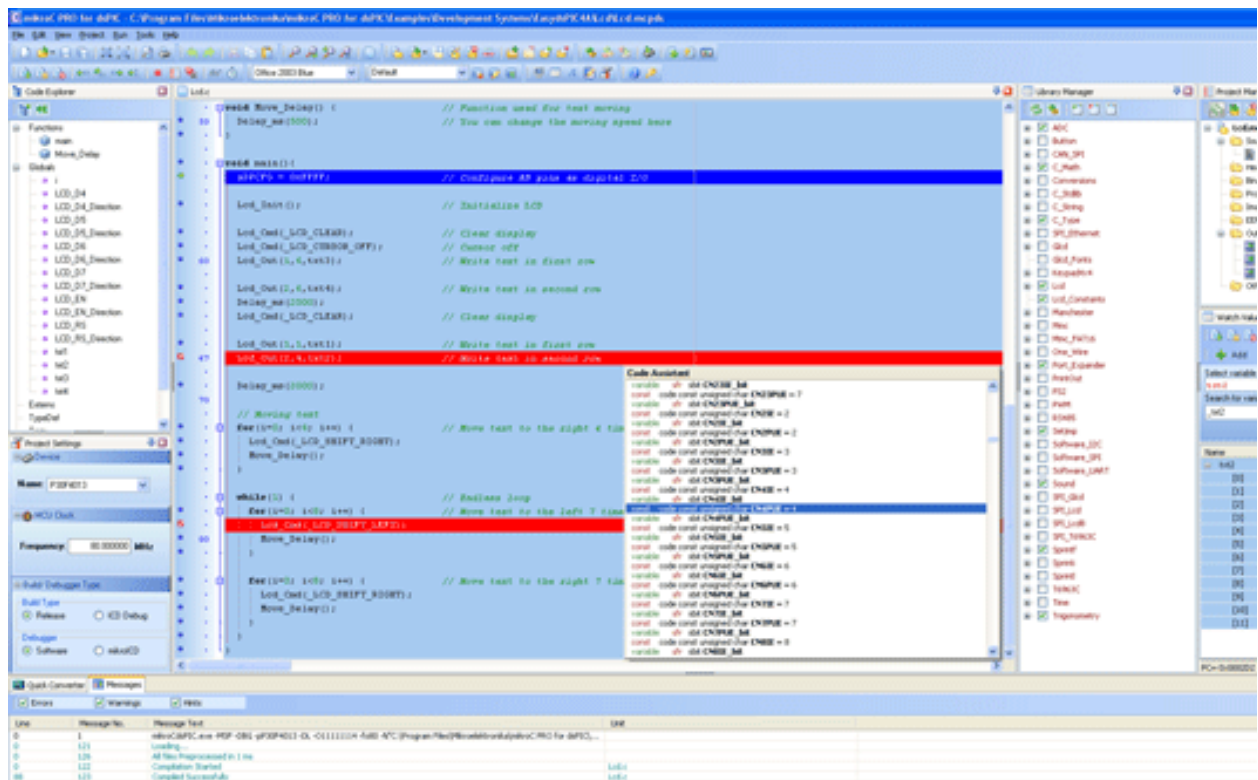

mikoC PRO for dsPIC30/33 and PIC24 IDE

Introduction to mikroC PRO for dsPIC30/33 and PIC24

dsPIC30/33 and PIC24 and C fit together well: dsPIC is designed as PIC with digital signal processing capabilities. These are Microchip's first inherent 16-bit (data) microcontrollers. They build on the PIC's existing strength offering hardware MAC (multiply-accumulate), barrel shifting, bit reversal, (16x16)-bit multiplication and other digital signal processing operations. Having a wide range of application, being prized for its efficiency, dsPIC30/33 and PIC24 MCUs are a natural choice for developing embedded systems. mikroC PRO for dsPIC30/33 and PIC24 provides a successful match featuring highly advanced IDE, ANSI compliant compiler, broad set of hardware libraries, comprehensive documentation, and plenty of ready-to-run examples.

Features

mikroC PRO for dsPIC30/33 and PIC24 allows you to quickly develop and deploy complex applications:

- Write your source code using the built-in Code Editor (Code and Parameter Assistants, Code Folding, Syntax Highlighting, Auto Correct, Code Templates, and more.)
- Use included mikroC PRO for dsPIC30/33 and PIC24 libraries to dramatically speed up the development: data acquisition, memory, displays, conversions, communication etc.
- Monitor your program structure, variables, and functions in the Code Explorer.
- Generate commented, human-readable assembly, and standard HEX compatible with all programmers.
- Use the integrated mikroICD (In-Circuit Debugger) Real-Time debugging tool to monitor program execution on the hardware level.
- Inspect program flow and debug executable logic with the integrated Software Simulator.
- Generate COFF(Common Object File Format) file for software and hardware debugging under Microchip's MPLAB software.
- Use Single Static Assignment optimization to shrink your code to even smaller size.
- Get detailed reports and graphs: RAM and ROM map, code statistics, assembly listing, calling tree, and more.
- Active Comments enable you to make your comments alive and interactive.
- mikroC PRO for dsPIC30/33 and PIC24 provides plenty of examples to expand, develop, and use as building bricks in your projects. Copy them entirely if you deem fit – that's why we included them with the compiler.

Where to Start

- In case that you're a beginner in programming dsPIC30/33 and PIC24 microcontrollers, read carefully the dsPIC Specifics chapter. It might give you some useful pointers on dsPIC30/33 and PIC24 constraints, code portability, and good programming practices.
- If you are experienced in C programming, you will probably want to consult mikroC PRO for dsPIC30/33 and PIC24 Specifics first. For language issues, you can always refer to the comprehensive Language Reference. A complete list of included libraries is available at mikroC PRO for dsPIC30/33 and PIC24 Libraries.
- If you are not very experienced in C programming, don't panic! mikroC PRO for dsPIC30/33 and PIC24 provides plenty of examples making it easy for you to go quickly. We suggest that you first consult Projects and Source Files, and then start browsing the examples that you're the most interested in.

Copyright (c) 2002-2010 mikroElektronika. All rights reserved.
What do you think about this topic ? Send us feedback!

What's new in mikroC PRO for dsPIC30/33 and PIC24

IDE build 4.60

Command line build 4.60

New features and enhancements in the following areas will boost your productivity by helping you complete many tasks more easily and in less time.

For a complete version history of mikroC PRO for dsPIC30/33 and PIC24, visit the following link : http://www.mikroe.com/download/eng/documents/compilers/mikroc/pro/dspic/version_history.txt

- Compiler Changes
- IDE Changes

Compiler Changes

Fixed :

- Optimization issues in specific cases when destination variable is in Rx space.
- Alignment not set for the first variable which is the first in block of initializers.

IDE Changes

Fixed :

- Error in Code Explorer in case void interrupt is defined (without brackets).
- Compiler version is not visible in caption if no projects are open.
- Parameter assistant ignores commas when switching to another parameter.
- Occasional lost of configuration flags when switching between projects.
- Improper display of RAM memory usage in statistics.

Improved :

- Communication to programmer concerning supported chips.
- License Key Request form.

Software License Agreement

mikroElektronika Associates License Statement and Limited Warranty

IMPORTANT - READ CAREFULLY

This license statement and limited warranty constitute a legal agreement (“License Agreement”) between you (either as an individual or a single entity) and mikroElektronika (“mikroElektronika Associates”) for software product (“Software”) identified above, including any software, media, and accompanying on-line or printed documentation.

BY INSTALLING, COPYING, OR OTHERWISE USING SOFTWARE, YOU AGREE TO BE BOUND BY ALL TERMS AND CONDITIONS OF THE LICENSE AGREEMENT.

Upon your acceptance of the terms and conditions of the License Agreement, mikroElektronika Associates grants you the right to use Software in a way provided below.

This Software is owned by mikroElektronika Associates and is protected by copyright law and international copyright treaty. Therefore, you must treat this Software like any other copyright material (e.g., a book).

You may transfer Software and documentation on a permanent basis provided. You retain no copies and the recipient agrees to the terms of the License Agreement. Except as provided in the License Agreement, you may not transfer, rent, lease, lend, copy, modify, translate, sublicense, time-share or electronically transmit or receive Software, media or documentation. You acknowledge that Software in the source code form remains a confidential trade secret of mikroElektronika Associates and therefore you agree not to modify Software or attempt to reverse engineer, decompile, or disassemble it, except and only to the extent that such activity is expressly permitted by applicable law notwithstanding this limitation.

If you have purchased an upgrade version of Software, it constitutes a single product with the mikroElektronika Associates software that you upgraded. You may use the upgrade version of Software only in accordance with the License Agreement.

LIMITED WARRANTY

Respectfully excepting the Redistributables, which are provided “as is”, without warranty of any kind, mikroElektronika Associates warrants that Software, once updated and properly used, will perform substantially in accordance with the accompanying documentation, and Software media will be free from defects in materials and workmanship, for a period of ninety (90) days from the date of receipt. Any implied warranties on Software are limited to ninety (90) days.

mikroElektronika Associates’ and its suppliers’ entire liability and your exclusive remedy shall be, at mikroElektronika Associates’ option, either (a) return of the price paid, or (b) repair or replacement of Software that does not meet mikroElektronika Associates’ Limited Warranty and which is returned to mikroElektronika Associates with a copy of your receipt. DO NOT RETURN ANY PRODUCT UNTIL YOU HAVE CALLED MIKROELEKTRONIKA ASSOCIATES FIRST AND OBTAINED A RETURN AUTHORIZATION NUMBER. This Limited Warranty is void if failure of Software has resulted from an accident, abuse, or misapplication. Any replacement of Software will be warranted for the rest of the original warranty period or thirty (30) days, whichever is longer.

TO THE MAXIMUM EXTENT PERMITTED BY APPLICABLE LAW, MIKROELEKTRONIKA ASSOCIATES AND ITS SUPPLIERS DISCLAIM ALL OTHER WARRANTIES AND CONDITIONS, EITHER EXPRESSED OR IMPLIED, INCLUDED, BUT NOT LIMITED TO IMPLIED WARRANTIES OF MERCHANTABILITY, FITNESS FOR A PARTICULAR PURPOSE, TITLE, AND NON-INFRINGEMENT, WITH REGARD TO SOFTWARE, AND THE PROVISION OF OR FAILURE TO PROVIDE SUPPORT SERVICES.

IN NO EVENT SHALL MIKROELEKTRONIKA ASSOCIATES OR ITS SUPPLIERS BE LIABLE FOR ANY SPECIAL, INCIDENTAL, INDIRECT, OR CONSEQUENTIAL DAMAGES WHATSOEVER (INCLUDING, WITHOUT LIMITATION, DAMAGES FOR LOSS OF BUSINESS PROFITS AND BUSINESS INFORMATION, BUSINESS INTERRUPTION, OR ANY OTHER PECUNIARY LOSS) ARISING OUT OF THE USE OF OR INABILITY TO USE SOFTWARE PRODUCT OR THE PROVISION OF OR FAILURE TO PROVIDE SUPPORT SERVICES, EVEN IF MIKROELEKTRONIKA ASSOCIATES HAS BEEN ADVISED OF THE POSSIBILITY OF SUCH DAMAGES. IN ANY CASE, MIKROELEKTRONIKA ASSOCIATES' ENTIRE LIABILITY UNDER ANY PROVISION OF THIS LICENSE AGREEMENT SHALL BE LIMITED TO THE AMOUNT ACTUALLY PAID BY YOU FOR SOFTWARE PRODUCT PROVIDED, HOWEVER, IF YOU HAVE ENTERED INTO A MIKROELEKTRONIKA ASSOCIATES SUPPORT SERVICES AGREEMENT, MIKROELEKTRONIKA ASSOCIATES' ENTIRE LIABILITY REGARDING SUPPORT SERVICES SHALL BE GOVERNED BY THE TERMS OF THAT AGREEMENT.

HIGH RISK ACTIVITIES

Software is not fault-tolerant and is not designed, manufactured or intended for use or resale as on-line control equipment in hazardous environments requiring fail-safe performance, such as in the operation of nuclear facilities, aircraft navigation or communication systems, air traffic control, direct life support machines, or weapons systems, in which the failure of Software could lead directly to death, personal injury, or severe physical or environmental damage ("High Risk Activities"). mikroElektronika Associates and its suppliers specifically disclaim any expressed or implied warranty of fitness for High Risk Activities.

GENERAL PROVISIONS

This statement may only be modified in writing signed by you and an authorised officer of mikroElektronika Associates. If any provision of this statement is found void or unenforceable, the remainder will remain valid and enforceable according to its terms. If any remedy provided is determined to have failed for its essential purpose, all limitations of liability and exclusions of damages set forth in the Limited Warranty shall remain in effect.

This statement gives you specific legal rights; you may have others, which vary, from country to country. mikroElektronika Associates reserves all rights not specifically granted in this statement.

mikroElektronika

Visegradska 1A,
11000 Belgrade,
Europe.

Phone: + 381 11 36 28 830

Fax: +381 11 36 28 831

Web: www.mikroe.com

E-mail: office@mikroe.com

Technical Support

The latest software can be downloaded free of charge via Internet (you might want to bookmark the page so you could check news, patches, and upgrades later on): [www.mikroe.com/en/compilers/mikroC PRO/dspic/download.htm](http://www.mikroe.com/en/compilers/mikroC_PRO/dspic/download.htm) .

In case you encounter any problem, you are welcome to our support forums at www.mikroe.com/forum/. Here, you may also find helpful information, hardware tips, and practical code snippets. Your comments and suggestions on future development of the mikroC PRO for dsPIC30/33 and PIC24 are always appreciated — feel free to drop a note or two on our Wishlist.

In our Knowledge Base www.mikroe.com/en/kb/ you can find the answers to Frequently Asked Questions and solutions to known problems. If you can not find the solution to your problem in Knowledge Base then report it to Support Desk www.mikroe.com/en/support/. In this way, we can record and track down bugs more efficiently, which is in our mutual interest. We respond to every bug report and question in a suitable manner, ever improving our technical support.

How to Register

The latest version of the mikroC PRO for dsPIC30/33 and PIC24 is always available for downloading from our website. It is a fully functional software with the mikroICD(in-circuit Debugger), all the libraries, examples, and comprehensive help included.

The only limitation of the free version is that it cannot generate hex output over 2K of program words. Although it might sound restrictive, this margin allows you to develop practical, working applications with no thinking of demo limit. If you intend to develop really complex projects in the mikroC PRO for dsPIC30/33 and PIC24, then you should consider the possibility of purchasing the license key.

Who Gets the License Key

Buyers of the mikroC PRO for dsPIC30/33 and PIC24 are entitled to the license key. After you have completed the payment procedure, you have an option of registering your mikroC PRO for dsPIC30/33 and PIC24. In this way you can generate hex output without any limitations.

How to Get License Key

After you have completed the payment procedure, start the program. Select **Help** › **How to Register** from the drop-down menu or click the How To Register Icon  .

You can choose between two registering methods, **I work online** or **I work offline**, based on your current internet connection and click **Request license key now** button :

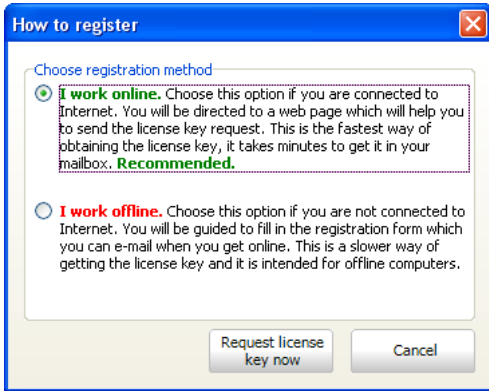

If you choose I work online registering method, following page will be opened in your default browser :

...making it simple

DEVELOPMENT TOOLS | COMPILERS | BOOKS
Email: office@mikroe.com

[Home](#) | [Development Tools](#) | [Compilers](#) | [Accessory Boards](#) | [Special Offers](#) | [Easy Buy](#) | [Publications](#) | [Support](#) | [Projects](#) | [Download](#)

Software Activation

In order to get activation key please fill in required fields. Upon receiving and verifying your request, we will send the license key to the e-mail address you specified in the form.

Product:

Name* :

Address:

Invoice:

2CO Number:

Email* :

Re-enter email* :

Company:

Product ID:

Comment:

Distributor* :



Type the two words.

program 1744

Related Links: [Products](#) | [News](#) | [Forums](#) | [Distributors](#) | [About MikroElektronika](#) | [Legal Information and Privacy Policy](#) | [Product Archive](#) | [Contact Us](#)

Copyright © 1998-2010, MikroElektronika. All rights reserved. All trade and/or services marks mentioned are the property of their respective owners.

Fill out the registration form, select your distributor, and click the **Submit** button.

If you choose **I work offline** registering method, following window will be opened :

How To Register

Step 1. Fill in the form below. Please, make sure you fill in all required fields.
Step 2. Make sure that you provided a **valid email address** in the "EMAIL" edit box. This email will be used for sending you the activation key.
Step 3. Make sure you select a correct distributor which will make the registration process faster. If your distributor is not on the list then select "Other" and type in distributor's email address in the box below.
Step 4. Press the **SEND** button to send key request. A default email client will open with ready-to-send message.
Note: If email client does not open, you may copy text of the message and paste it manually into a new email message before sending it to your distributor's email.

NAME*	Filip Jankovic
ADDRESS	Enter your address
INVOICE	Enter invoice number if available in the form AAAAA/BB
2CO Number	Enter 2CheckOut Order Number if available (10 digits)
E-MAIL*	filip@mikroe.com
E-MAIL*	filip@mikroe.com
COMPANY	Enter company name
PRODUCT ID	3F47-546774-7F6A73-655D
COMMENTS:	
DISTRIBUTOR*	mikroElektronika key@mikroe.com

*** Required fields**

I have made the payment and I wish to request activation key for **mikroC PRO for dsPIC**

Name:
Filip Jankovic

Address:

Copy to clipboard SEND Cancel

Fill out the registration form, select your distributor, and click the Submit button.

This will start your e-mail client with message ready for sending. Review the information you have entered, and add the comment if you deem it necessary. Please, do not modify the subject line.

Upon receiving and verifying your request, we will send the license key to the e-mail address you specified in the form.

After Receiving the License Key

The license key comes as a small autoextracting file – just start it anywhere on your computer in order to activate your copy of compiler and remove the demo limit. You do not need to restart your computer or install any additional components. Also, there is no need to run the mikroC PRO for dsPIC30/33 and PIC24 at the time of activation.

Important :

- The license key is valid until you format your hard disk. In case you need to format the hard disk, you should request a new activation key.
- Please keep the activation program in a safe place. Every time you upgrade the compiler you should start this program again in order to reactivate the license.

CHAPTER 2

mikroC PRO for dsPIC30/33 and PIC24 Environment

Main Menu Options

Available Main Menu options are:

File

Edit

View

Project

Build

Run

Tools

Help

Related topics: Keyboard shortcuts, Toolbars

File

File Menu Options

The File menu is the main entry point for manipulation with the source files.

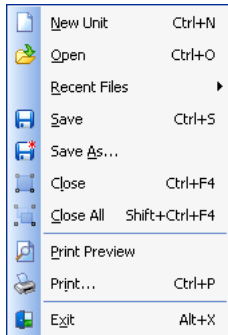

File	Description
New Unit Ctrl+N	Open a new editor window.
Open Ctrl+O	Open source file for editing or image file for viewing.
Recent Files ▶	Reopen recently used file.
Save Ctrl+S	Save changes for active editor.
Save As...	Save the active source file with the different name or change the file type.
Close Ctrl+F4	Close active source file.
Close All Shift+Ctrl+F4	Close all opened files.
Print Preview	Print Preview.
Print... Ctrl+P	Print.
Exit Alt+X	Exit IDE.

Related topics: Keyboard shortcuts, File Toolbar, Managing Source Files





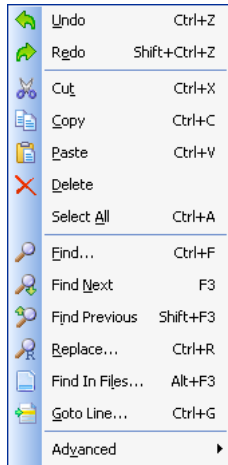

Edit

Edit Menu Options

The Edit Menu contains commands for editing the contents of the current document.



Edit	Description
Undo Ctrl+Z	Undo last change.
Redo Shift+Ctrl+Z	Redo last change.
Cut Ctrl+X	Cut selected text to clipboard.
Copy Ctrl+C	Copy selected text to clipboard.
Paste Ctrl+V	Paste text from clipboard.
Delete	Delete selected text.
Select All Ctrl+A	Select all text in active editor.
Find... Ctrl+F	Find text in active editor.
Find Next F3	Find next occurrence of text in active editor.
Find Previous Shift+F3	Find previous occurrence of text in active editor.
Replace... Ctrl+R	Replace text in active editor.
Find In Files... Alt+F3	Find text in current file, in all opened files, or in files from desired folder.
Goto Line... Ctrl+G	Go to line to the desired line in active editor.
Advanced ▶	Advanced Code Editor options

Advanced »	Description
 Comment Shift+Ctrl+,	Comment selected code or put single line comment if there is no selection.
 Uncomment Shift+Ctrl+,	Uncomment selected code or remove single line comment if there is no selection.
 Indent Shift+Ctrl+I	Indent selected code.
 Outdent Shift+Ctrl+U	Outdent selected code.
 Lowercase Ctrl+Alt+L	Changes selected text case to lowercase.
 Uppercase Ctrl+Alt+U	Changes selected text case to uppercase.
 Titlecase Ctrl+Alt+T	Changes selected text case to titlecase.

Find Text

Dialog box for searching the document for the specified text. The search is performed in the direction specified. If the string is not found a message is displayed.

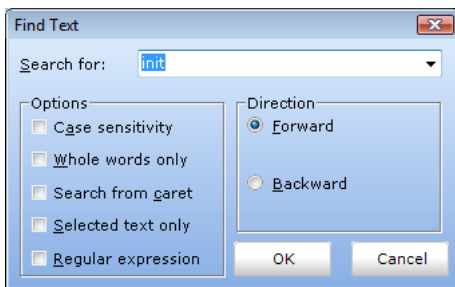

Replace Text

Dialog box for searching for a text string in file and replacing it with another text string.

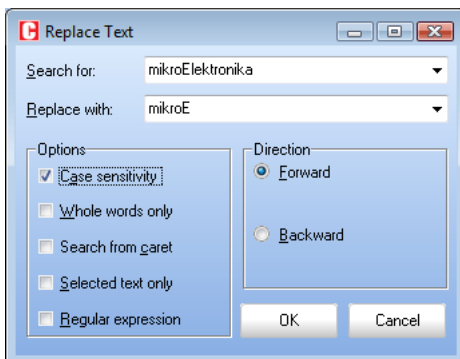

Find In Files

Dialog box for searching for a text string in current file, all opened files, or in files on a disk.

The string to search for is specified in the **Text to find** field. If Search in directories option is selected, The files to search are specified in the **Files mask** and **Path** fields.

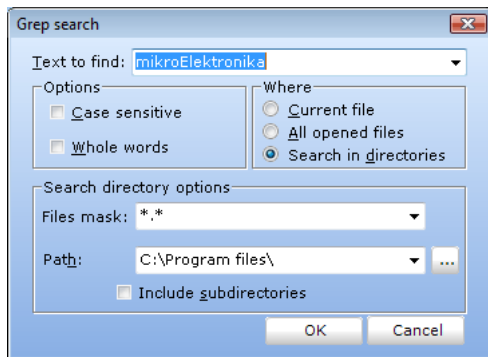

Go To Line

Dialog box that allows the user to specify the line number at which the cursor should be positioned.

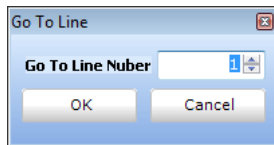

Regular expressions option

By checking this box, you will be able to advance your search, through Regular expressions.

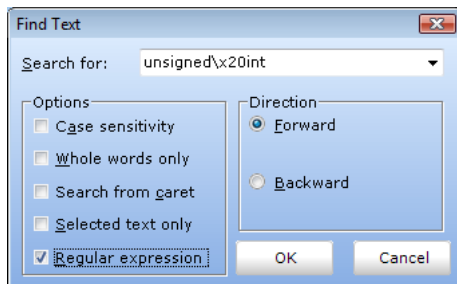









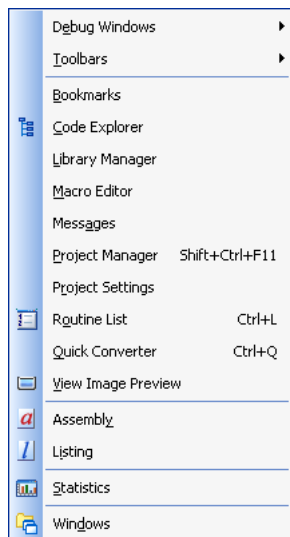

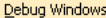

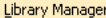

Related topics: Keyboard shortcuts, Edit Toolbar, Advanced Edit Toolbar

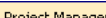
View

View Menu Options

View Menu contains commands for controlling the on-screen display of the current project.



View	Description
 Debug Windows	Show/Hide Software Simulator / mikroICD (In-Circuit Debugger) Debug Windows.
 Toolbars	Show/Hide Toolbars.
 Bookmarks	Show/Hide Bookmarks window.
 Code Explorer	Show/Hide Code Explorer window.
 Library Manager	Show/Hide Library Manager window.
 Macro Editor	Show/Hide Macro Editor window.
 Messages	Show/Hide Messages window.
 Project Manager	Shift+Ctrl+F11 Show/Hide Project Manager window.
 Project Settings	Show/Hide Project Settings window.
 Routine List	Ctrl+L Show/Hide Routine List in active editor.
 Quick Converter	Ctrl+Q Show/Hide Quick Converter window.
 View Image Preview	Show/Hide View Image Preview window.
 View Assembly	View Assembly.
 View Listing	View Listing.
 View Statistics	View Statistics.
 Windows	Show Window List window.

The Tools toolbar can easily be customized by adding new tools in Options(F12) window.

Related topics: Keyboard shortcuts, Integrated Tools

Project

Project Menu Options

Project Menu allows user to easily manipulate current project.

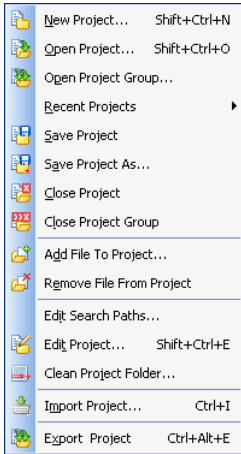





Project	Description
New Project... Shift+Ctrl+N	Open New Project Wizard
Open Project... Shift+Ctrl+O	Open existing project.
Open Project Group...	Open project group.
Recent Projects ▶	Open recently used project or project group.
Save Project	Save current project.
Save Project As...	Save active project file with the different name.
Close Project	Close active project.
Close Project Group	Close project group.
Add File To Project...	Add file to project.
Remove File From Project	Remove file from project.
Edit Search Paths...	Edit search paths.
Edit Project... Shift+Ctrl+E	Edit project settings
Clean Project Folder...	Clean Project Folder
Export Project Ctrl+Alt+E	Export Project.





Related topics: Keyboard shortcuts, Project Toolbar, Creating New Project, Project Manager, Project Settings

Build

Build Menu Options

Build Menu allows user to easily manage building and compiling process.

 Build	Ctrl+F9
 Rebuild All Sources	Alt+F9
 Build All Projects	Shift+F9
 Stop Build All	Ctrl+F12
 Build + Program	Ctrl+F11

Build	Description
 Build Ctrl+F9	Build active project.
 Rebuild All Sources Alt+F9	Rebuild all sources in active project.
 Build All Projects Shift+F9	Build all projects.
 Stop Build All Ctrl+F12	Stop building of all projects.
 Build + Program Ctrl+F11	Build and program active project.

Related topics: Keyboard shortcuts, Project Toolbar, Creating New Project, Project Manager, Project Settings

Run

Run Menu Options

Run Menu is used to debug and test compiled code on a software or hardware level.

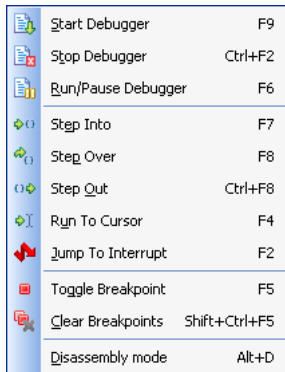

Run	Description
Start Debugger F9	Start Software Simulator or mikroICD (In-Circuit Debugger).
Stop Debugger Ctrl+F2	Stop debugger.
Run/Pause Debugger F6	Run/Pause Debugger.
Step Into F7	Step Into.
Step Over F8	Step Over.
Step Out Ctrl+F8	Step Out.
Run To Cursor F4	Run To Cursor.
Jump To Interrupt F2	Jump to interrupt in current project.
Toggle Breakpoint F5	Toggle Breakpoint.
Clear Breakpoints Shift+Ctrl+F5	Clear Breakpoints.
Disassembly mode Alt+D	Toggle between source and disassembly.

Related topics: Keyboard shortcuts, Debug Toolbar

Tools

Tools Menu Options

Tools Menu contain a number of applications designed to ease the use of compiler and included library routines.

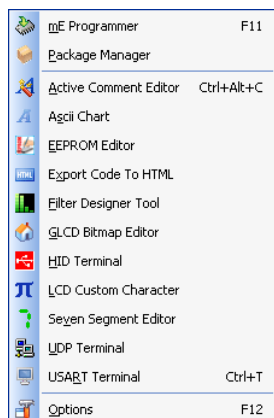

Tools	Description
mE Programmer F11	Run mikroElektronika Programmer.
Package Manager	Run Package Manager.
Active Comment Editor Ctrl+Alt+C	Show/Hide Active Comment Editor window.
Ascii Chart	Run ASCII Chart
EEPROM Editor	Run EEPROM Editor
Export Code To HTML	Generate HTML code suitable for publishing source code on the web.
Filter Designer Tool	Run Filter Designer Tool.
GLCD Bitmap Editor	Run Glcd bitmap editor
HID Terminal	Run HID Terminal
LCD Custom Character	Run Lcd custom character
Seven Segment Editor	Run Seven Segment Editor
UDP Terminal	Run UDP communication terminal
USART Terminal Ctrl+T	Run USART Terminal
Options F12	Open Options window

Related topics: Keyboard shortcuts, Tools Toolbar

Help

Help Menu Options

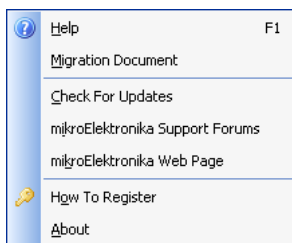

Help	Description
Help F1	Open Help File.
Migration Document	Open Code Migration Document.
Check For Updates	Check if new compiler version is available.
mikroElektronika Support Forums	Open mikroElektronika Support Forums in a default browser.
mikroElektronika Web Page	Open mikroElektronika Web Page in a default browser.
How To Register	Information on how to register
About	Open About window.

Related topics: Keyboard shortcuts, Help Toolbar

mikoC PRO for dsPIC30/33 and PIC24 IDE

IDE Overview

The mikoC PRO for dsPIC30/33 and PIC24 is an user-friendly and intuitive environment.

For a detailed information on a certain part of IDE, simply click on it (hovering a mouse cursor above a desired IDE part will pop-up its name) :

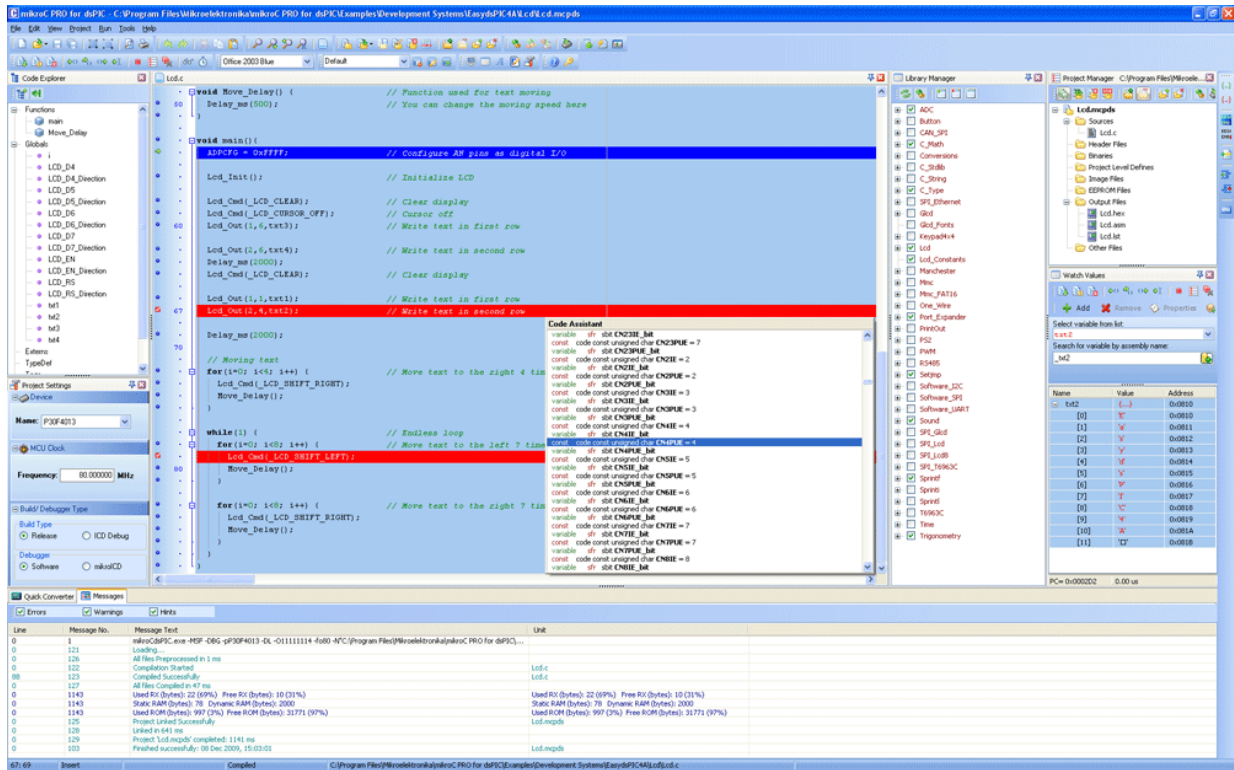

- The Code Editor features adjustable Syntax Highlighting, Code Folding, Code Assistant, Parameters Assistant, Spell Checker, Auto Correct for common typos and Code Templates (Auto Complete).
- The Code Explorer is at your disposal for easier project management.
- The Project Manager allows multiple project management.
- General project settings can be made in the Project Settings window.
- Library manager enables simple handling of libraries used in a project.
- The Messages Window displays all messages during compiling and linking.
- The source-level Software Simulator lets you debug executable logic step-by-step by watching the program flow.
- The New Project Wizard is a fast, reliable, and easy way to create a project.
- Help files are syntax and context sensitive.
- Like in any modern Windows application, you may customize the layout of mikoC PRO for dsPIC30/33 and PIC24 to suit your needs best.
- Spell checker underlines identifiers which are unknown to the project. In this way it helps the programmer to spot potential problems early, much before the project is compiled.
- Spell checker can be disabled by choosing the option in the Preferences dialog (F12).

Code Editor

The Code Editor is advanced text editor fashioned to satisfy needs of professionals. General code editing is the same as working with any standard text-editor, including familiar Copy, Paste and Undo actions, common for Windows environment.

Available Code Editor options are: Editor Settings, Editor Colors, Auto Correct, Auto Complete and Style.

Editor Settings

Main Editor Settings Features are :

- Auto Save
- Highlighter
- Spelling
- Comment Style
- Code Folding
- Code Assistant
- Parameter Assistant
- Bookmarks and Go to Line

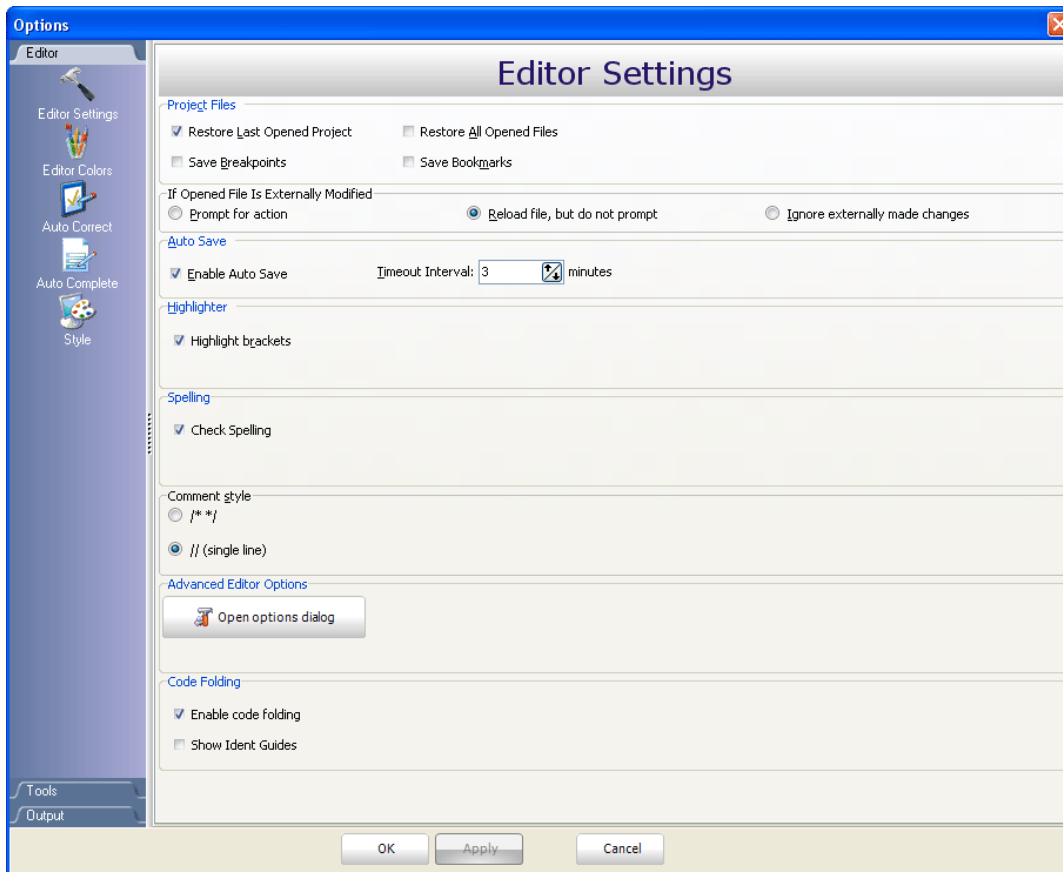

Auto Save

Auto Save is a function which saves an opened project automatically, helping to reduce the risk of data loss in case of a crash or freeze. Autosaving is done in time intervals defined by the user.

Highlighter



Highlighting is a convenient feature for spotting brackets which notate begin or end of a routine, by making them visually distinct.

Spelling

The Spell Checker underlines unknown objects in the code, so they can be easily noticed and corrected before compiling your project.



Select **Tools** > **Options** from the drop-down menu, or click the Show Options Icon  and then select the Spell Checker Tab.

Comment Style

Code Editor has a feature to change the comment style to either single-line or multi-line. Commenting or uncommenting the selected code is done by a simple click of a mouse, using the Comment Icon  and Uncomment Icon  from the Advanced Edit Toolbar.

Code Folding

Code folding is IDE feature which allows users to selectively hide and display sections of a source file. In this way it is easier to manage large regions of code within one window, while still viewing only those subsections of the code that are relevant during a particular editing session.

While typing, the code folding symbols ( and ) appear automatically. Use the folding symbols to hide/unhide the code subsections.

```

void main() {
    PORTA = 0;
    PORTB = 0;
    Lcd_Init();
    Lcd_Out(1, 1, txt[0]);
    Lcd_Out(2, 1, txt[1]);
    delay_ms(1000);
    Lcd_Cmd(1);

    Lcd_Out(1, 1, txt[1]);
    Lcd_Out(2, 4, txt[2]);
    delay_ms(500);
}

```

 void main() {

Another way of folding/unfolding code subsections is by using Alt+← and Alt+→.

If you place a mouse cursor over the tooltip box, the collapsed text will be shown in a tooltip style box.

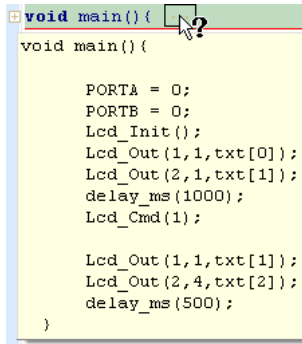

```
void main() {  
void main() {  
  
    PORTA = 0;  
    PORTE = 0;  
    Lcd_Init();  
    Lcd_Out(1, 1, txt[0]);  
    Lcd_Out(2, 1, txt[1]);  
    delay_ms(1000);  
    Lcd_Cmd(1);  
  
    Lcd_Out(1, 1, txt[1]);  
    Lcd_Out(2, 4, txt[2]);  
    delay_ms(500);  
}
```

Code Assistant

If you type the first few letters of a word and then press Ctrl+Space, all valid identifiers matching the letters you have typed will be prompted in a floating panel (see the image below). Now you can keep typing to narrow the choice, or you can select one from the list using the keyboard arrows and Enter.



```
sp  
variable sfr unsigned char SP  
variable sfr unsigned char SPDR  
variable sfr unsigned char SPSR  
variable sfr unsigned char SPCR
```

Parameter Assistant

The Parameter Assistant will be automatically invoked when you open parenthesis "(" or press Shift+Ctrl+Space. If the name of a valid function precedes the parenthesis, then the expected parameters will be displayed in a floating panel. As you type the actual parameter, the next expected parameter will become bold.



```
ADC_Read(channel : char)
```

Bookmarks

Bookmarks make navigation through a large code easier. To set a bookmark, use Ctrl+Shift+number. The same principle applies to the removal of the bookmarks. To jump to a bookmark, use Ctrl+number.

Go to Line

The Go to Line option makes navigation through a large code easier. Use the shortcut Ctrl+G to activate this option.

Column Select Mode

This mode changes the operation of the editor for selecting text. When column select mode is used, highlighted text is based on the character column position of the first character selected to the column of the last character of text selected.

Text selected in this mode does not automatically include all text between the start and end position, but includes all text in the columns between the first and last character selected.

Column mode editing is sometimes referred to as block mode editing as the act of selecting text forms a rectangle.

To enter this mode, press Alt + Left mouse button, drag the mouse towards the desired direction thus selecting the text.

Editor Colors

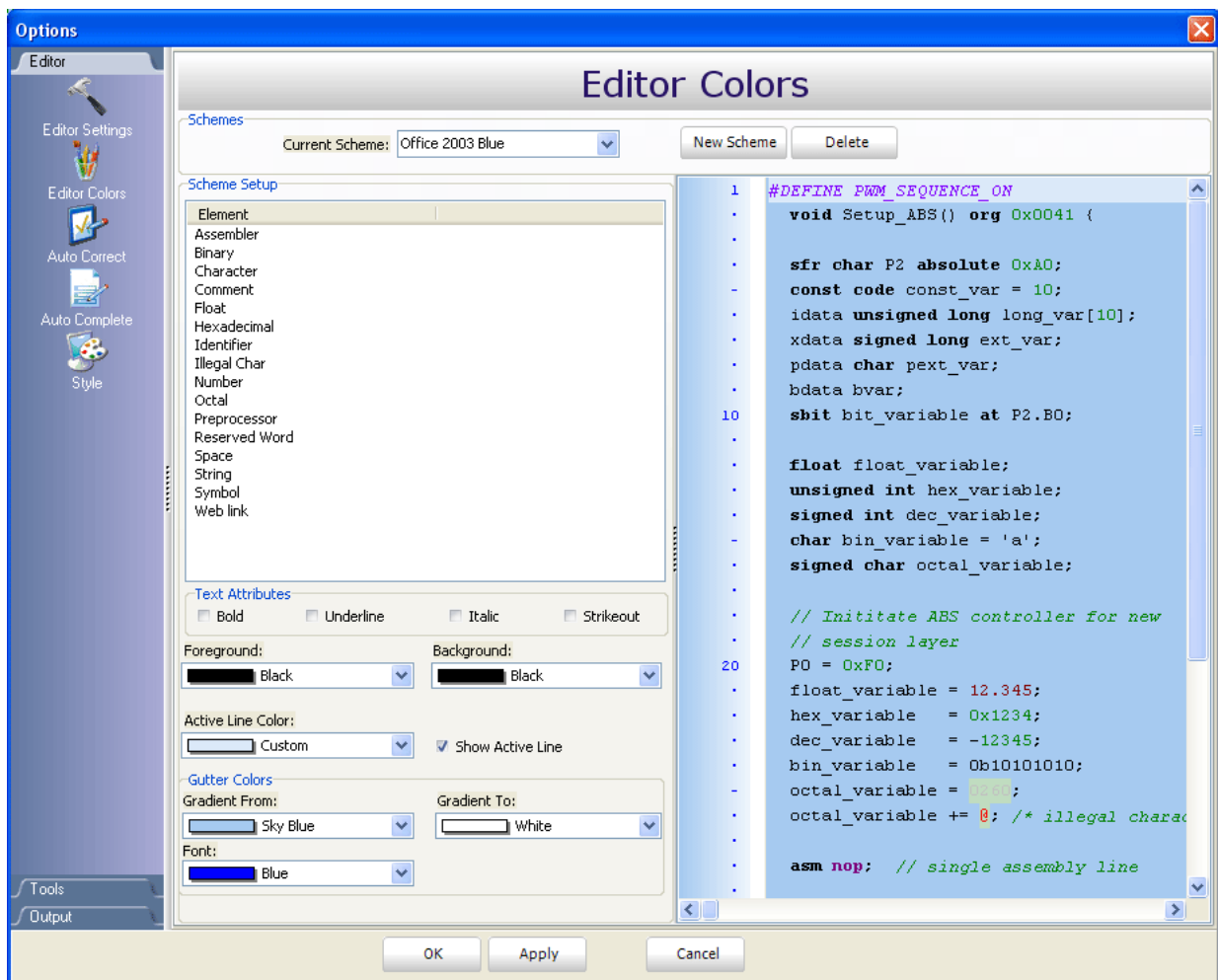

Editor Colors option allows user to set, change and save text and color settings organized in schemes. Schemes represent custom graphical appearance that can be applied to GUI(Graphical User Interface) to satisfy tastes of different users.

Auto Correct

Auto Correct option facilitate user in such a fashion that it automatically corrects common typing or spelling errors as it types.

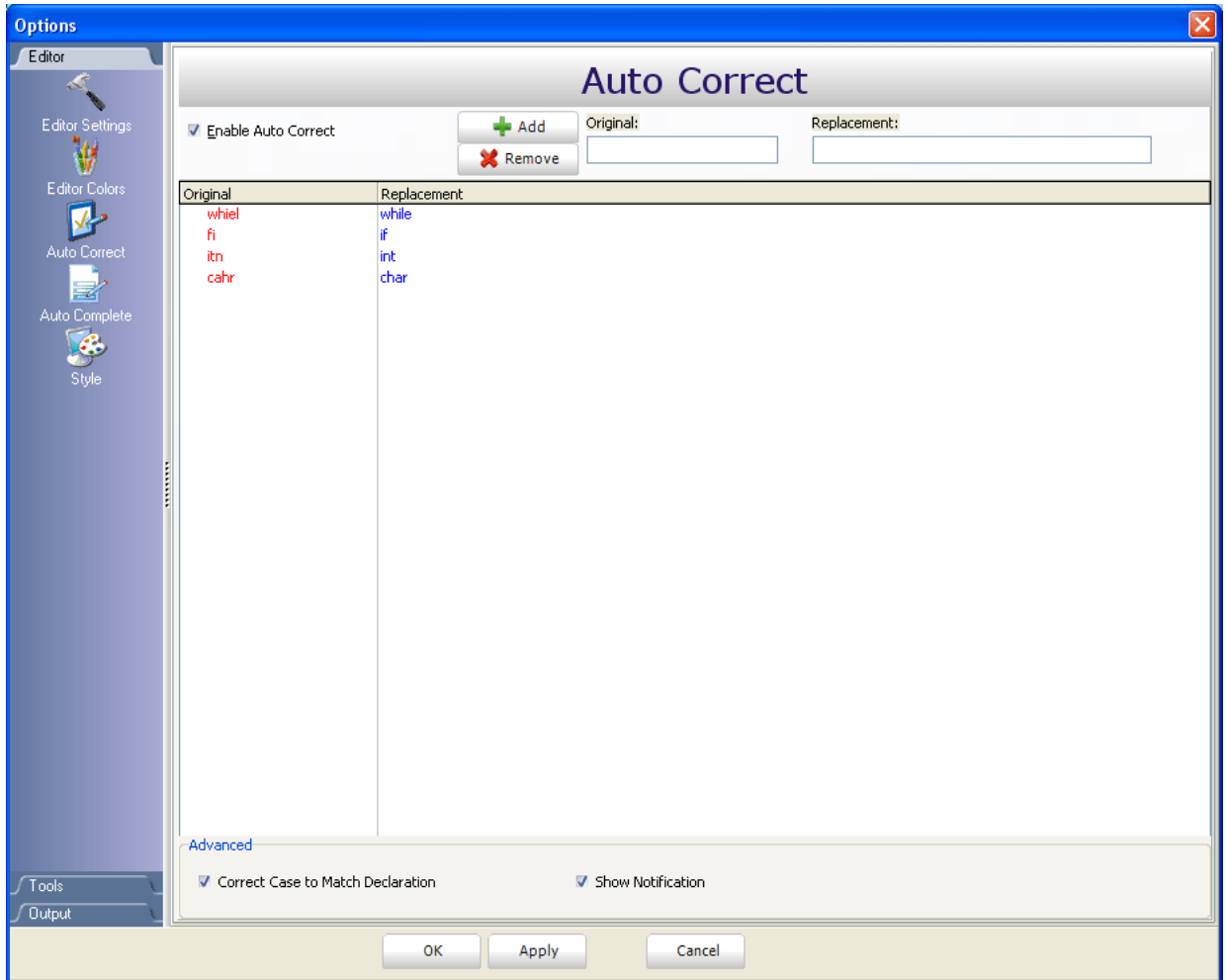

This option is already set up to automatically correct some words. For example, if you type whiel, it will be corrected to while when you press the spacebar :

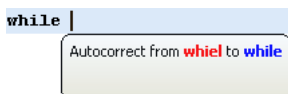

User can easily add its common typos by entering original typo, for example btye, to the Original box, and replacement, byte, to the Replacement box, and just click "Add" button. Next time when the typo occurs, it will be automatically corrected.

Auto Complete (Code Templates)

Auto Complete option saves lots of keystrokes for commonly used phrases by automatically completing user's typing.

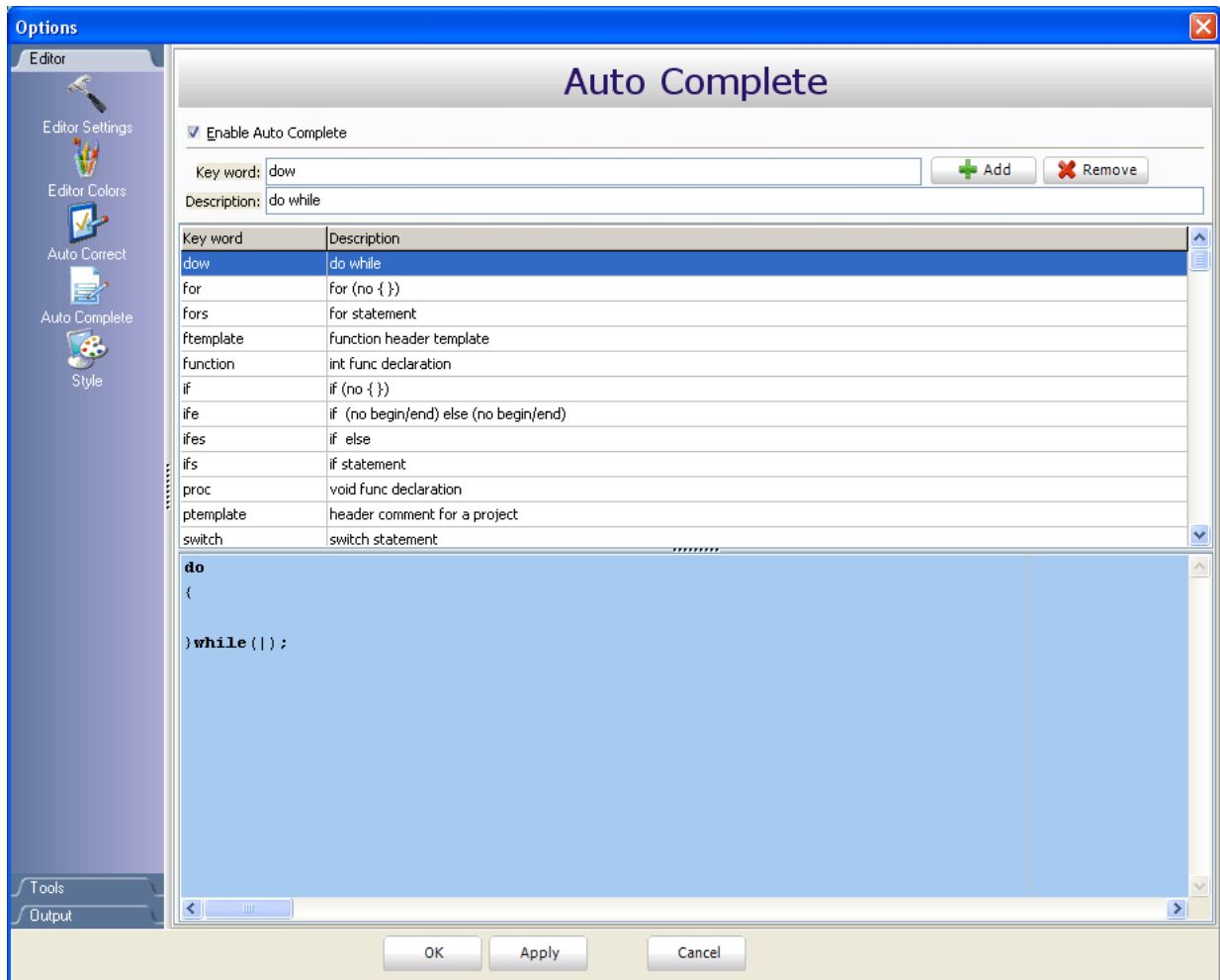

User can insert the Code Template by typing the name of the template (for instance, `dow`), then press Ctrl+J and the Code Editor will automatically generate a code :

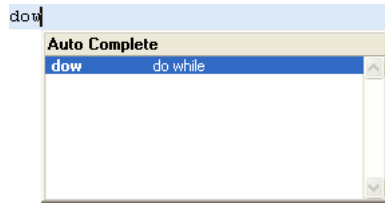

You can add your own templates to the list by entering the desired keyword, description and code of your template in appropriate boxes.

Autocomplete macros can retrieve system and project information :

- `%DATE%` - current system date
- `%TIME%` - current system time
- `%DEVICE%` - device(MCU) name as specified in project settings
- `%DEVICE_CLOCK%` - clock as specified in project settings
- `%COMPILER%` - current compiler version



These macros can be used in template code, see template `ptemplate` provided with mikroC PRO for dsPIC30/33 and PIC24 installation.

Code Explorer

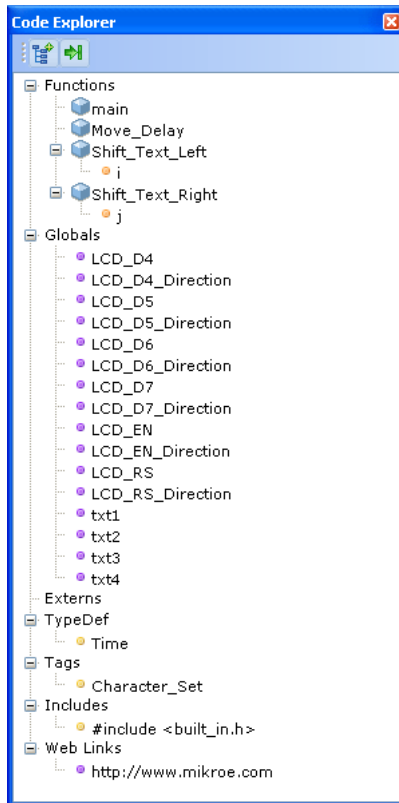
The Code Explorer gives clear view of each item declared inside the source code. You can jump to a declaration of any item by double clicking it, or pressing the Enter button. Also, besides the list of defined and declared objects, code explorer displays message about first error and it's location in code.



Following options are available in the Code Explorer:

Icon	Description
	Expand/Collapse all nodes in tree.
	Locate declaration in code.

Routine List

Routine list displays list of routines, and enables filtering routines by name. Routine list window can be accessed by pressing Ctrl+L.

You can jump to a desired routine by double clicking on it, or pressing the Enter button. Also, you can sort routines by size or by address.

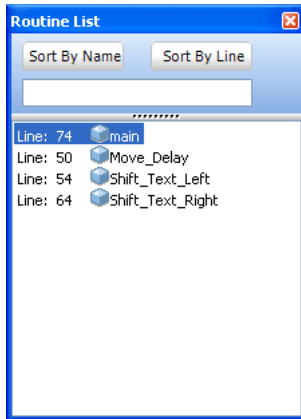

Project Manager







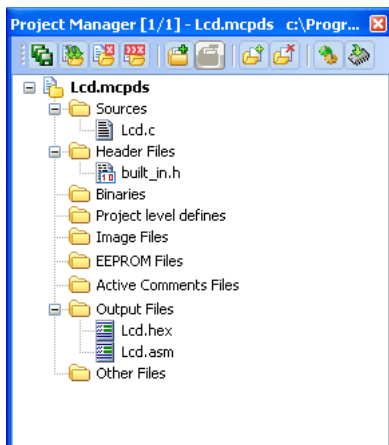



Project Manager is IDE feature which allows users to manage multiple projects. Several projects which together make project group may be open at the same time. Only one of them may be active at the moment.

Setting project in **active** mode is performed by **double clicking** the desired project in the Project Manager, which will result in bolding the project's name.

Also, the name of the currently active project will be displayed in the Program Manager window title, alongside with the number of projects in project group.



Following options are available in the Project Manager:

Icon	Description
	Save project Group.
	Open project group.
	Close the active project.
	Close project group.
	Add project to the project group.
	Remove project from the project group.
	Add file to the active project.
	Remove selected file from the project.
	Build the active project.
	Run mikroElektronika's Flash programmer.

For details about adding and removing files from project see Add/Remove Files from Project.

Related topics: Project Settings, Project Menu Options, File Menu Options, Project Toolbar, Build Toolbar, Add/Remove Files from Project

Project Settings

Following options are available in the Project Settings :

- Device - select the appropriate device from the device drop-down list.
- MCU Clock - enter the clock frequency value.
- Build/Debugger Type - choose debugger type.

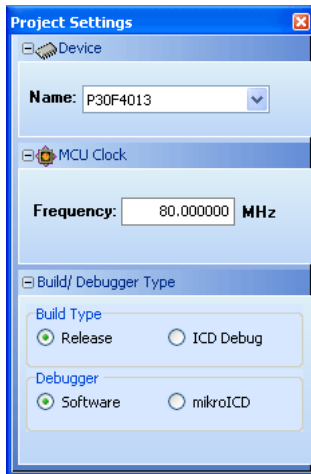

Related topics: [Edit Project](#), [Customizing Projects](#), [Project Manager](#)

Library Manager





Library Manager enables simple handling libraries being used in a project. Library Manager window lists all libraries (extension .mcl) which are instantly stored in the compiler Uses folder. The desirable library is added to the project by selecting check box next to the library name.

In order to have all library functions accessible, simply press the button **Check All**  and all libraries will be selected.

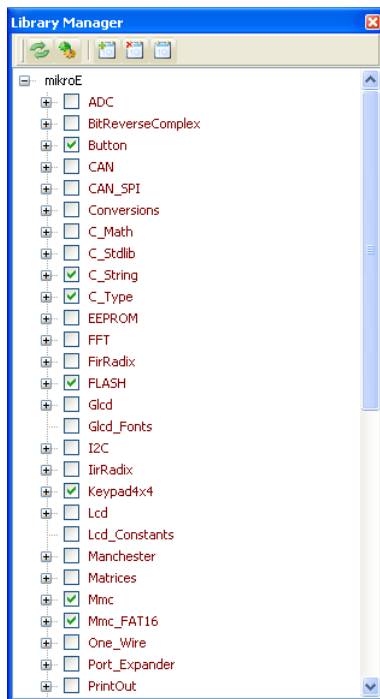
In case none library is needed in a project, press the button **Clear All**  and all libraries will be cleared from the project.

Only the selected libraries will be linked.



Icon	Description
	Refresh Library by scanning files in "Uses" folder. Useful when new libraries are added by copying files to "Uses" folder.
	Rebuild all available libraries. Useful when library sources are available and need refreshing.
	Include all available libraries in current project.
	No libraries from the list will be included in current project.
	Restore library to the state just before last project saving.

Managing libraries using Package Manager

The Package Manager is a tool which enables users to easily install their own libraries in the mikroIDE. Libraries are distributed in the form of a package, which is an archive composed of one or more files, containing libraries. For more information on Package Manager, visit our website.

Upon package installation, a new node with the package name will be created in the Library Manager. For example :

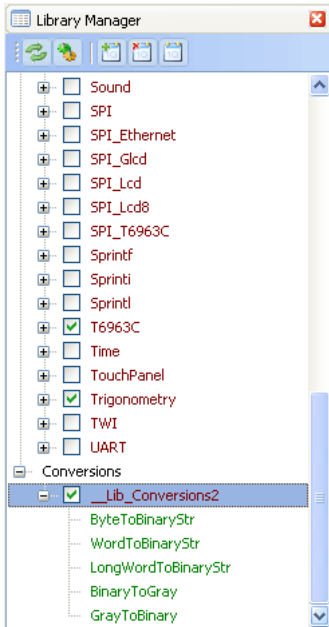

From the Library Manager, user can also uninstall the desired package by right clicking the the appropriate node, and from the drop-down menu choose Uninstall package :

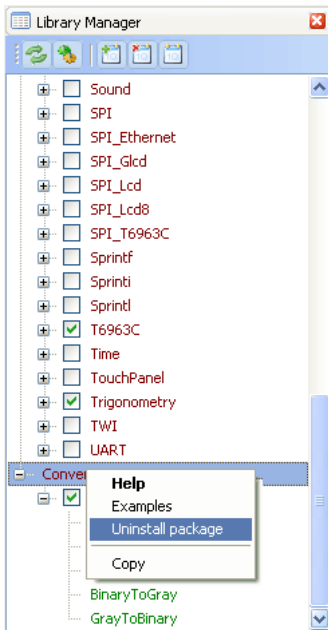

Related topics: mikroC PRO for PIC Libraries, Creating New Library

Statistics

After successful compilation, you can review statistics of your code. Click the Statistics Icon  .

Memory Usage Windows

Provides overview of RAM and ROM usage in the various forms.

RAM Memory Usage

Displays RAM memory usage in a pie-like form.

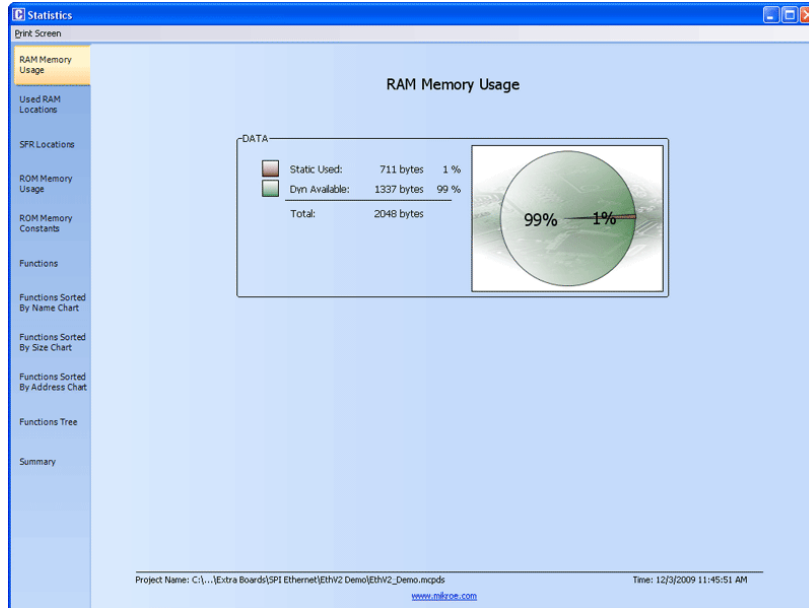

Used RAM Locations

Displays used RAM memory locations and their names.

Used RAM Locations

* Click on Name column header to toggle between Name and Unique Assembler Name

Address	Name	Address	Name	Address	Name
0x0000	WREG	0x7FFFFFFF	dl	0x7FFFFFFF	c
0x0000	W0	0x7FFFFFFF	type	0x7FFFFFFF	?lstr130_EthV2_Demo
0x0000	WREG0	0x7FFFFFFF	a	0x7FFFFFFF	?FLOC__SPI_Ethernet_UserUDP
0x0002	WREG1	0x7FFFFFFF	f	0x7FFFFFFF	buffer
0x0002	W1	0x7FFFFFFF	q	0x7FFFFFFF	?lstr132_EthV2_Demo
0x0004	WREG2	0x7FFFFFFF	align	0x7FFFFFFF	?lstr131_EthV2_Demo
0x0004	W2	0x7FFFFFFF	len	0x7FFFFFFF	loc_word
0x0006	WREG3	0x7FFFFFFF	tx	0x7FFFFFFF	reqLength
0x0006	W3	0x7FFFFFFF	tcpFlags	0x7FFFFFFF	out_char
0x0008	W4	0x7FFFFFFF	port	0x7FFFFFFF	i
0x0008	WREG4	0x7FFFFFFF	remotePort	0x7FFFFFFF	tts
0x000A	WREG5	0x7FFFFFFF	swap	0x7FFFFFFF	in
0x000A	W5	0x7FFFFFFF	syn	0x7FFFFFFF	jd
0x000C	WREG6	0x7FFFFFFF	transmit	0x7FFFFFFF	I
0x000C	W6	0x7FFFFFFF	datalen	0x7FFFFFFF	ts
0x000E	W7	0x7FFFFFFF	replen	0x7FFFFFFF	out
0x000E	WREG7	0x7FFFFFFF	start	0x7FFFFFFF	e
0x0010	WREG8	0x7FFFFFFF	ipHeaderLen	0x7FFFFFFF	N
0x0010	W8	0x7FFFFFFF	m	0x7FFFFFFF	?FLOC__Time_epochToDate
0x0012	WREG9	0x7FFFFFFF	?lstr3__Lib_EthEnc28j60	0x7FFFFFFF	L
0x0012	W9	0x7FFFFFFF	?lstr4__Lib_EthEnc28j60	0x7FFFFFFF	J
0x0014	W10	0x7FFFFFFF	align	0x7FFFFFFF	K
0x0014	WREG10	0x7FFFFFFF	packetEndAddr	0x7FFFFFFF	found
0x0016	WREG11	0x7FFFFFFF	i	0x7FFFFFFF	s1
0x0016	W11	0x7FFFFFFF	payloadAddr	0x7FFFFFFF	character
0x0018	WREG12	0x7FFFFFFF	c	0x7FFFFFFF	character

SFR Locations

Displays list of used SFR locations.

Address	Name	Address	Name	Address	Name
0x0000	WREG (_WREG)	0x033C	C1RX1EIDL	0x5543	?lstr_112_EthV2_Demo
0x0000	W0	0x0340	C1TX2SIDbits	0x5546	?lstr_129_EthV2_Demo
0x0000	WREG0 (_WREG0)	0x0340	C1TX2SID	0x5549	?lstr_110_EthV2_Demo
0x0002	WREG1 (_WREG1)	0x0342	C1TX2EID	0x554C	?lstr_125_EthV2_Demo
0x0002	W1	0x0342	C1TX2EIDbits	0x554F	?lstr_95_EthV2_Demo
0x0004	WREG2 (_WREG2)	0x0344	C1TX2DLC	0x5552	?lstr_93_EthV2_Demo
0x0004	W2	0x0344	C1TX2DLCbits	0x5555	?lstr_74_EthV2_Demo
0x0006	WREG3 (_WREG3)	0x0346	C1TX2B1	0x5557	?lstr_69_EthV2_Demo
0x0006	W3	0x0348	C1TX2B2	0x5559	?lstr_127_EthV2_Demo
0x0008	W4	0x034A	C1TX2B3	0x555B	?lstr_47_EthV2_Demo
0x0008	WREG4 (_WREG4)	0x034C	C1TX2B4	0x555D	?lstr_80_EthV2_Demo
0x000A	WREG5 (_WREG5)	0x034E	C1TX2CONbits	0x555F	?lcs_serverPrecision
0x000A	W5	0x034E	C1TX2CON	0x7FFFFFFF	DHCPRecvReturnValue
0x000C	WREG6 (_WREG6)	0x0350	C1TX1SID	0x7FFFFFFF	?lstr41_EthV2_Demo
0x000C	W6	0x0350	C1TX1SIDbits	0x7FFFFFFF	?lstr40_EthV2_Demo
0x000E	W7	0x0352	C1TX1EID	0x7FFFFFFF	!bDone (SPI_Ethernet
0x000E	WREG7 (_WREG7)	0x0352	C1TX1EIDbits	0x7FFFFFFF	tempServerID (SPI_Et
0x0010	WREG8 (_WREG8)	0x0354	C1TX1DLC	0x7FFFFFFF	?lstr39_EthV2_Demo
0x0010	W8	0x0354	C1TX1DLCbits	0x7FFFFFFF	v (SPI_Ethernet_DHCP
0x0012	WREG9 (_WREG9)	0x0356	C1TX1B1	0x7FFFFFFF	! (SPI_Ethernet_DHCP
0x0012	W9	0x0358	C1TX1B2	0x7FFFFFFF	type (SPI_Ethernet_DH
0x0014	W10	0x035A	C1TX1B3	0x7FFFFFFF	now (SPI_Ethernet_init
0x0014	WREG10 (_WREG10)	0x035C	C1TX1B4	0x7FFFFFFF	sourcePort (FARG_SPI
0x0016	WREG11 (_WREG11)	0x035E	C1TX1CON	0x7FFFFFFF	destPort (FARG_SPI_E
0x0016	W11	0x035E	C1TX1CONbits	0x7FFFFFFF	destIP (FARG_SPI_Eth
0x0018	WREG12 (_WREG12)	0x0360	C1TX1EID	0x7FFFFFFF	!ation (SPI_Ethernet

ROM Memory Usage

Displays ROM memory space usage in a pie-like form.

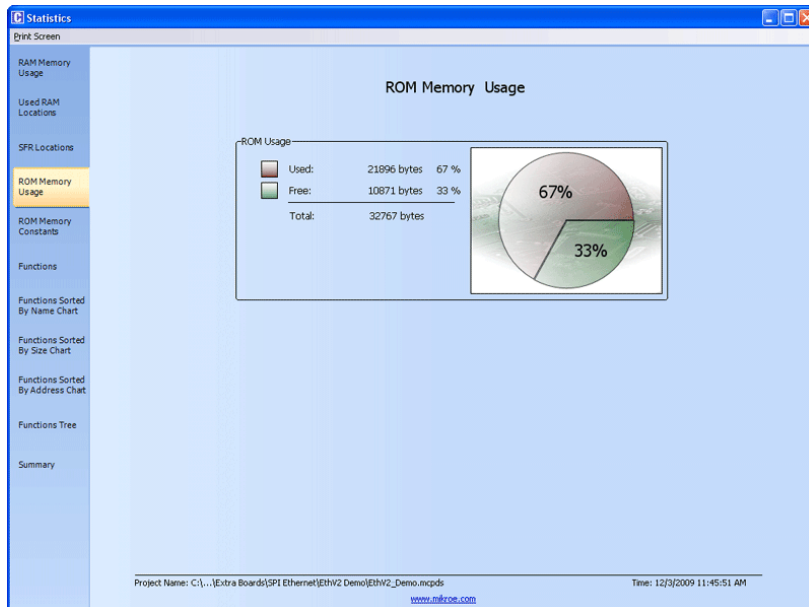

ROM Memory Constants

Displays ROM memory constants and their addresses.

The screenshot shows the 'Statistics' window with the 'ROM Memory Constants' section selected in the left sidebar. The main area displays a table of ROM memory constants.

Address	Name
0x5483	?1CS?str1__Lib_EthEnc28j60
0x529C	?1CS?str1_EthV2_Demo
0x5310	?1CS?str1_httpLibIs
0x51ED	?1CS?str10_EthV2_Demo
0x4C19	?1CS?str101_EthV2_Demo
0x4C22	?1CS?str102_EthV2_Demo
0x4C33	?1CS?str103_EthV2_Demo
0x4C45	?1CS?str104_EthV2_Demo
0x4C4C	?1CS?str105_EthV2_Demo
0x4C53	?1CS?str106_EthV2_Demo
0x4C5D	?1CS?str107_EthV2_Demo
0x4C7E	?1CS?str108_EthV2_Demo
0x51E9	?1CS?str11_EthV2_Demo
0x521C	?1CS?str12_EthV2_Demo
0x520B	?1CS?str13_EthV2_Demo
0x5259	?1CS?str130_EthV2_Demo
0x526A	?1CS?str131_EthV2_Demo
0x527B	?1CS?str132_EthV2_Demo
0x5214	?1CS?str14_EthV2_Demo
0x5220	?1CS?str15_EthV2_Demo
0x51E5	?1CS?str16_EthV2_Demo
0x4E4B	?1CS?str17_EthV2_Demo
0x4E54	?1CS?str18_EthV2_Demo
0x4E50	?1CS?str19_EthV2_Demo
0x5356	?1CS?str2__Lib_EthEnc28j60
0x4E58	?1CS?str2_EthV2_Demo

Functions

Sorts and displays functions in various ways.

The screenshot shows the 'Statistics' window with the 'Functions' section selected in the left sidebar. The main area displays a table of functions sorted by size. A note above the table indicates: '* Click on column header to sort table by Address, Name, Unique Assembler Name or Size'.

Address Asc	Name	Unique Assembler Name	Size (bytes)
0x084C	saveConf	_saveConf	2
0x38F6	SPI_Ethernet_getIpAddress	_SPI_Ethernet_getIpAddress	4
0x3D4E	SPI_Ethernet_getIpMask	_SPI_Ethernet_getIpMask	4
0x3CCC	SPI_Ethernet_getDnsIpAddress	_SPI_Ethernet_getDnsIpAddress	4
0x3CC8	SPI_Ethernet_getGwIpAddress	_SPI_Ethernet_getGwIpAddress	4
0x340E	Delay_50us	_Delay_50us	10
0x319E	Strobe	_Lib_Lcd_Strobe	10
0x2A7A	Delay_500us	_Delay_500us	10
0x33D6	Delay_8ms	_Delay_8ms	10
0x246E	Delay_1us	_Delay_1us	12
0x3418	Delay_5500us	_Delay_5500us	12
0x0358	_Multiply_32x32	_Multiply_32x32	14
0x31F6	Lcd_Chrr_CP	_Lcd_Chrr_CP	24
0x3184	SPI1_Read	_SPI1_Read	26
0x3424	SPI_Ethernet_delay	_SPI_Ethernet_delay	30
0x0FE6	SPI_Ethernet_writeMemory	_SPI_Ethernet_writeMemory	30
0x0E8C	SPI_Ethernet_setRxReadAddress	_SPI_Ethernet_setRxReadAddress	32
0x0366	strlen	_strlen	32
0x323E	strchr	_strchr	34
0x2ACC	islower	_islower	34
0x2484	isupper	_isupper	34
0x0386	isdigit	_isdigit	34
0x043A	strcpy	_strcpy	36
0x104A	SPI_Ethernet_MACswap	_SPI_Ethernet_MACswap	38

Functions Sorted By Name Chart

Sorts and displays functions by their name, in the ascending order.

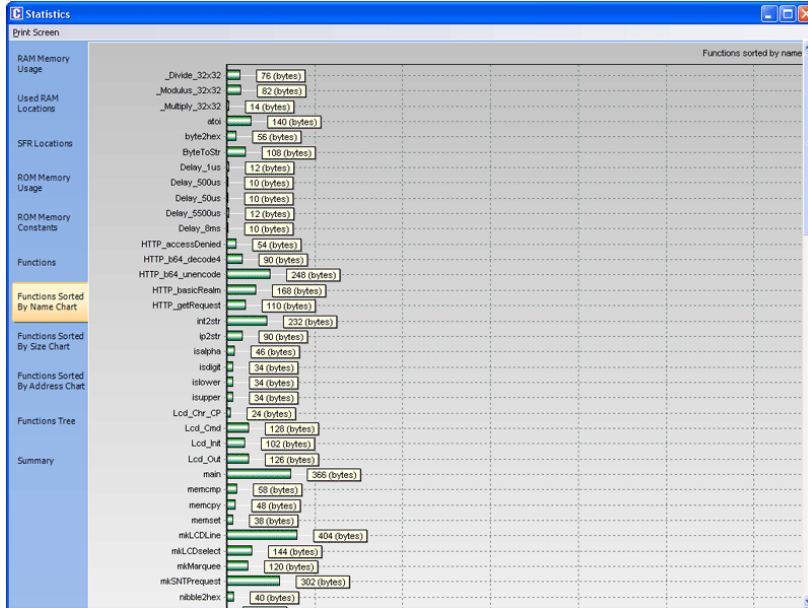

Functions Sorted By Size Chart

Sorts and displays functions by their sizes in a chart-like form.

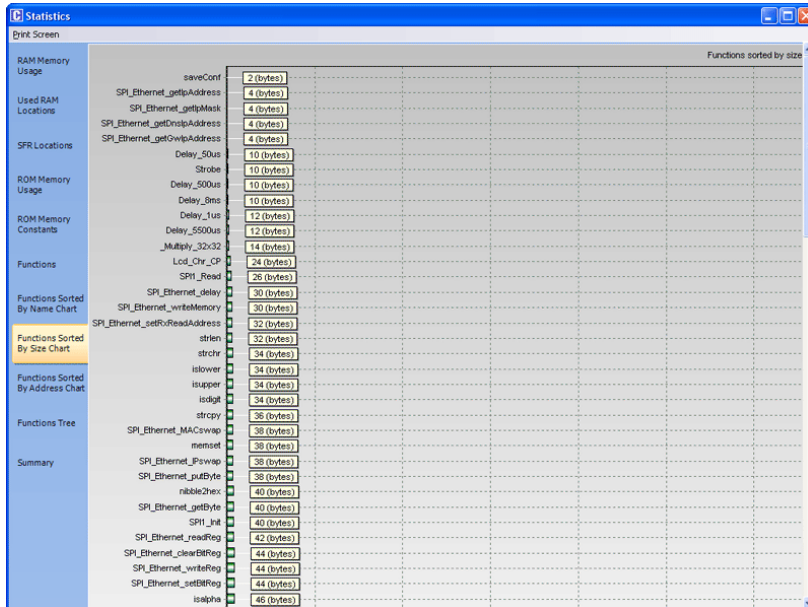

Functions Sorted By Addresses

Sorts and displays functions by their addresses, in the ascending order.

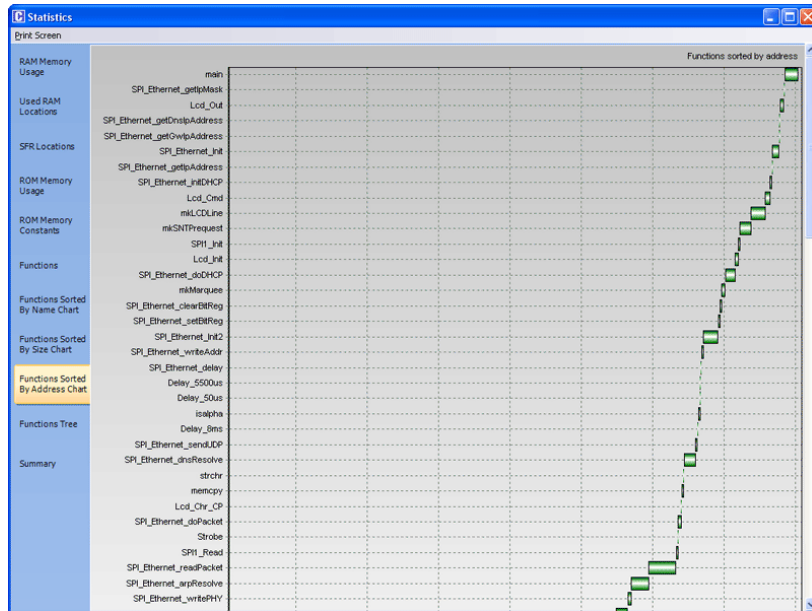

Function Tree

Displays Function Tree with the relevant data for each function.

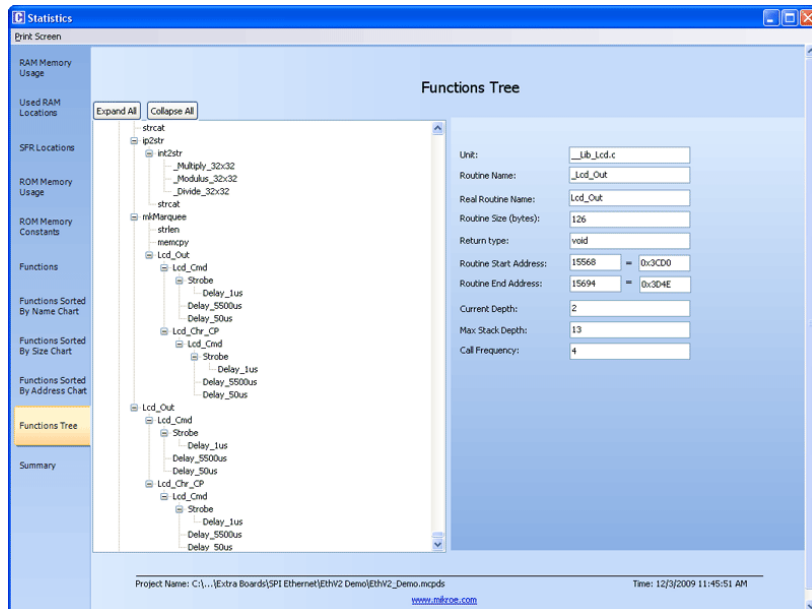

Memory Summary

Displays summary of RAM and ROM memory in a pie-like form.

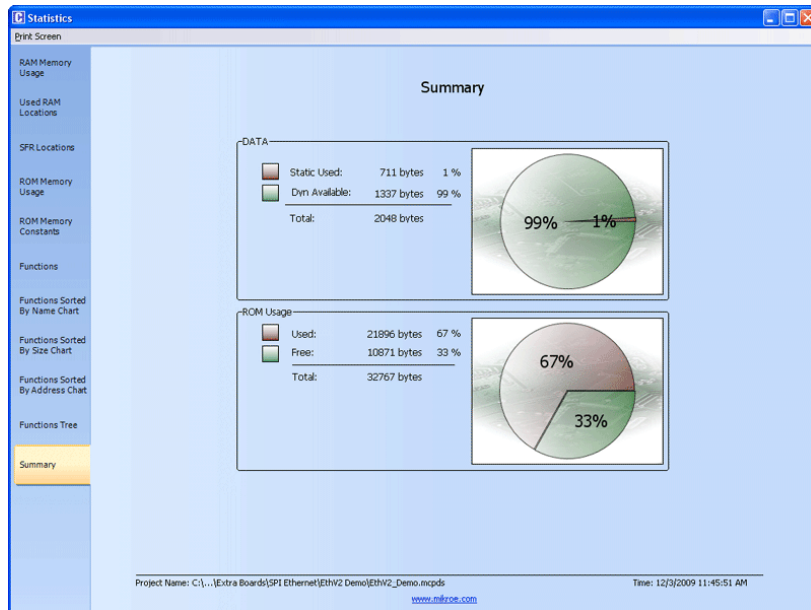

Messages Window

Messages Window displays various informations and notifications about the compilation process.

It reports for example, time needed for preprocessing, compilation and linking; used RAM and ROM space, generated baud rate with error percentage, etc.

User can filter which notifications will Messages Window display by checking Errors, Warning and Hints box.

In case that errors were encountered during compiling, the compiler will report them and won't generate a hex file. The Messages Window will display errors at the bottom of the window by default.

The compiler also reports warnings, but these do not affect the output; only errors can interfere with the generation of hex.

Line	Me...	Message Text	Unit
0	1	mikroCdsPIC.exe -MSF -DBG -pP30F4013 -LHF -GC -DL -SS...	
0	121	Loading...	
0	122	Compilation Started	Lib_Delays.c
574	123	Compiled Successfully	Lib_Delays.c
195	1162	Variable 'NumberOfCyc' has been eliminated by optimizer	Lib_Delays.c
246	1162	Variable 'NumberOfCyc' has been eliminated by optimizer	Lib_Delays.c
0	126	All files Preprocessed in 15 ms	
0	122	Compilation Started	Lcd.c
59	1506	Implicit conversion of pointer to int	Lcd.c
93	123	Compiled Successfully	Lcd.c
0	127	All files Compiled in 16 ms	
0	1143	Used RX (bytes): 21 (66%) Free RX (bytes): 11 (34%)	Used RX (bytes): 21 (66%) Free RX (bytes): 11 (34%)
0	1143	Static RAM (bytes): 45 Dynamic RAM (bytes): 2032	Static RAM (bytes): 45 Dynamic RAM (bytes): 2032
0	1143	Used ROM (bytes): 456 (1%) Free ROM (bytes): 32312 (9...)	Used ROM (bytes): 456 (1%) Free ROM (bytes): 32312 ...
0	125	Project Linked Successfully	Lcd.mcpds
0	1004	COFF file successfully generated	COFF file successfully generated
0	128	Linked in 812 ms	
0	129	Project 'Lcd.mcpds' completed: 1437 ms	
0	103	Finished successfully: 11 Nov 2009, 10:23:27	Lcd.mcpds

Double click the message line in the Message Window to highlight the line where the error was encountered.

Quick Converter

Quick Converter enables user to easily transform numbers from one base to another.

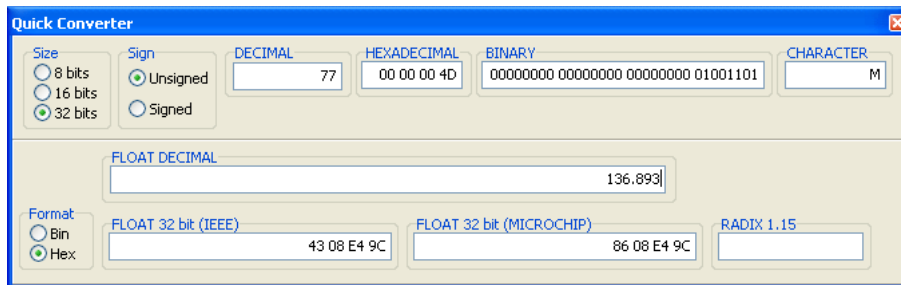

User can convert integers of various sizes (8, 16 or 32 bits), signed and unsigned, using different representation (decimal, hexadecimal, binary and character).



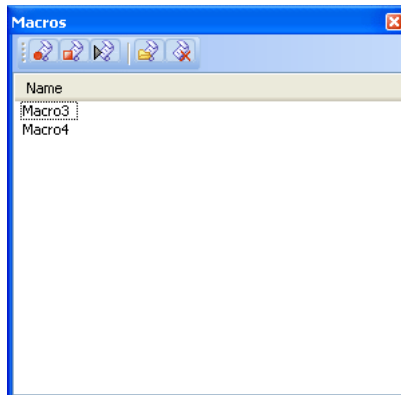

Also, Quick Converter features float point numbers conversion from/to Float Decimal, Float 32bit (IEEE), Float 32bit (Microchip) and Radix 1.15 for dsPIC family of MCUs.

Macro Editor

A macro is a series of keystrokes that have been 'recorded' in the order performed. A macro allows you to 'record' a series of keystrokes and then 'playback', or repeat, the recorded keystrokes.



The Macro offers the following commands:

Icon	Description
	Starts 'recording' keystrokes for later playback.
	Stops capturing keystrokes that was started when the Start Recording command was selected.
	Allows a macro that has been recorded to be replayed.
	New macro.
	Delete macro.

Related topics: Code Editor, Code Templates

Image Preview

There are a lot of occasions in which the user besides the code, must look at the appropriate schematics in order to successfully write the desired program.

The mikroC PRO for dsPIC30/33 and PIC24 provides this possibility through a **Image Preview Window**.

To add a image to the **Image Preview Window**, right click the **Image Files** node in the **Project Manager** :

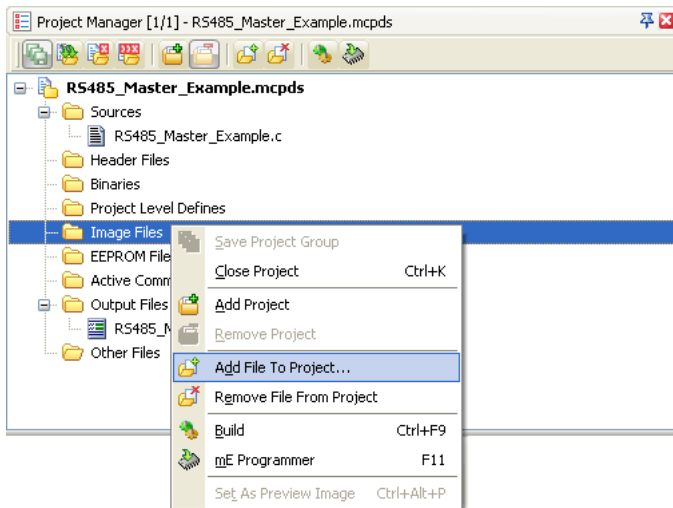

Now, navigate to the desired image file, and simply add it :

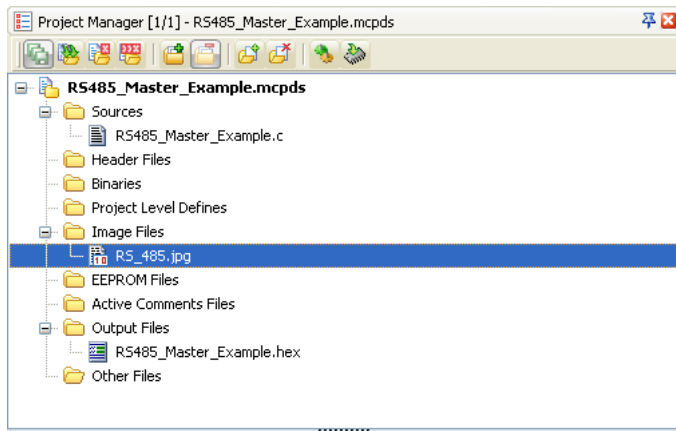

Next, right click the added file, and choose **Set As Preview Image** :

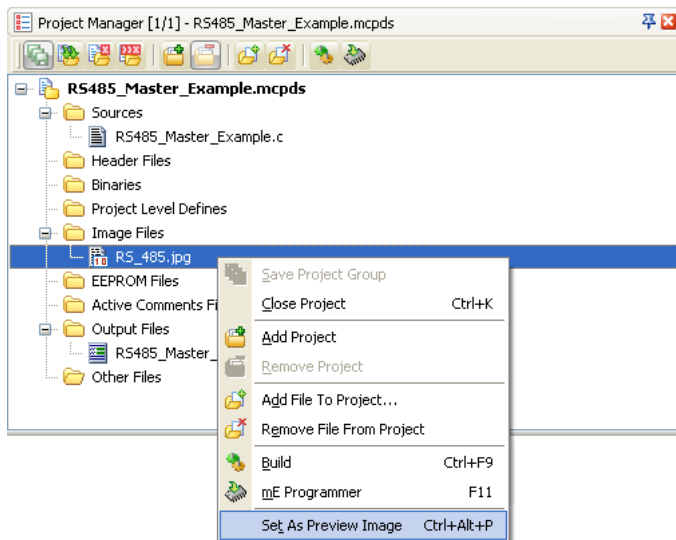

Once you have added the image, it will appear in the **Image Preview Window** :

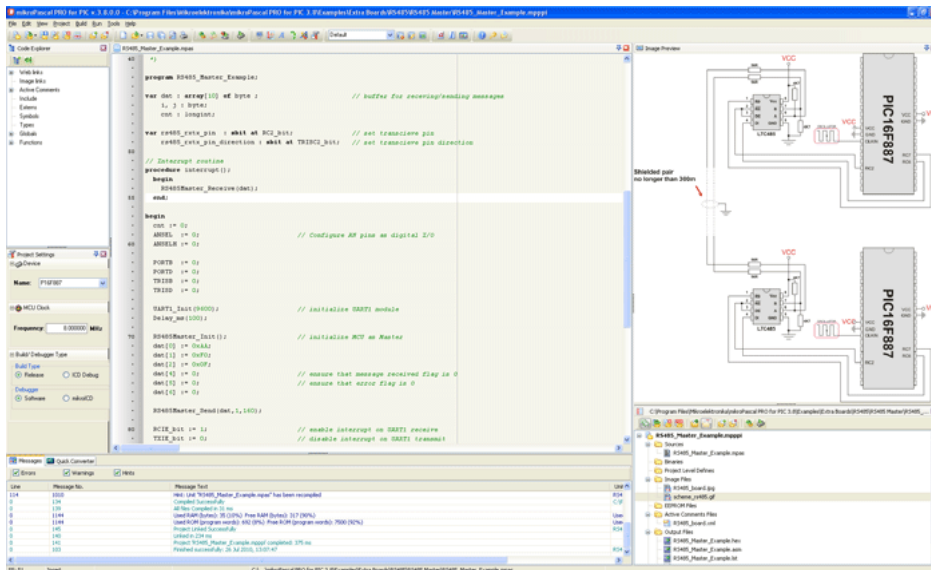

Also, you can add multiple images to the **Image Files** node, but only the one that is set will be automatically displayed in the **Image Preview Window** upon opening the project.

By changing the **Image Preview Window** size, displayed image will be fit by its height in such a way that its proportions will remain intact.

Toolbars







This section provides an overview of the toolbars available in mikroC PRO for dsPIC30/33 and PIC24 Help :

- File Toolbar
- Edit Toolbar
- Advanced Edit Toolbar
- Find Toolbar
- Project Toolbar
- Build Toolbar
- Debug Toolbar
- Styles Toolbar
- Tools Toolbar
- View Toolbar
- Layout Toolbar
- Help Toolbar

File Toolbar







File Toolbar is a standard toolbar with following options:

Icon	Description
	Opens a new editor window.
	Open source file for editing or image file for viewing.
	Save changes for active window.
	Save changes in all opened windows.
	Print Preview.
	Print.

Edit Toolbar



Edit Toolbar is a standard toolbar with following options:

Icon	Description
	Undo last change.
	Redo last change.
	Cut selected text to clipboard.
	Copy selected text to clipboard.
	Paste text from clipboard.

Advanced Edit Toolbar



Advanced Edit Toolbar comes with following options:

Icon	Description
	Comment selected code or put single line comment if there is no selection
	Uncomment selected code or remove single line comment if there is no selection.
	Select text from starting delimiter to ending delimiter.
	Go to ending delimiter.
	Go to line.
	Indent selected code lines.
	Outdent selected code lines.
	Generate HTML code suitable for publishing current source code on the web.

Find/Replace Toolbar











Find/Replace Toolbar is a standard toolbar with following options:

Icon	Description
	Find text in current editor.
	Find next occurrence.
	Find previous occurrence.
	Replace text.
	Find text in files.

Project Toolbar







Project Toolbar comes with following options:

Icon	Description
	New project.
	Open Project
	Save Project
	Edit project settings.
	Close current project.
	Clean project folder.
	Add File To Project
	Remove File From Project

Build Toolbar



Build Toolbar comes with following options:

Icon	Description
	Build current project.
	Build all opened projects.
	Build and program active project.
	Start programmer and load current HEX file.

Debug Toolbar



Debug Toolbar comes with following options:

Icon	Description
	Start Software Simulator or mikroICD (In-Circuit Debugger).
	Run/Pause Debugger.
	Stop Debugger.
	Step Into.
	Step Over.
	Step Out.
	Run To Cursor.
	Toggle Breakpoint.
	View Breakpoints Window
	Clear Breakpoints.
	View Watch Window
	View Stopwatch Window

Styles Toolbar



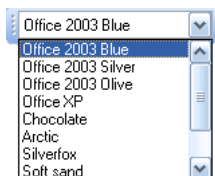



Styles toolbar allows you to easily change colors of your workspace.



Tools Toolbar



Tools Toolbar comes with following default options:



Icon	Description
	Run USART Terminal
	EEPROM
	ASCII Chart
	Seven Segment Editor.
	Open Active Comment editor.
	Options menu

Tip : The Tools toolbar can easily be customized by adding new tools in Options menu window.

View Toolbar



View Toolbar provides access to assembly code, listing file and statistics windows.

Icon	Description
	Open assembly code in editor.
	Open listing file in editor.
	View statistics for current project.

Layout Toolbar

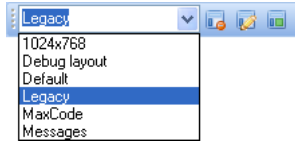

Styles toolbar allows you to easily customize workspace through a number of different IDE layouts.



Help Toolbar



Help Toolbar provides access to information on using and registering compilers :

Icon	Description
	Open Help file.
	How To Register.

Related topics: Keyboard shortcuts, Integrated Tools

Customizing IDE Layout

Docking Windows

You can increase the viewing and editing space for code, depending on how you arrange the windows in the IDE.

Step 1: Click the window you want to dock, to give it focus.

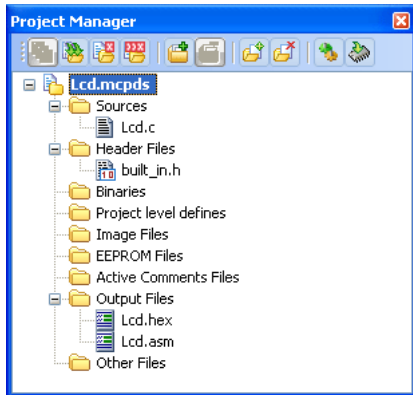

Step 2: Drag the tool window from its current location. A guide diamond appears. The four arrows of the diamond point towards the four edges of the IDE.

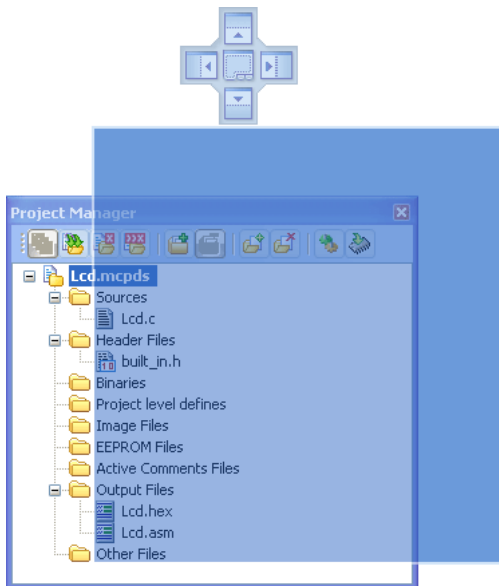

Step 3: Move the pointer over the corresponding portion of the guide diamond. An outline of the window appears in the designated area.

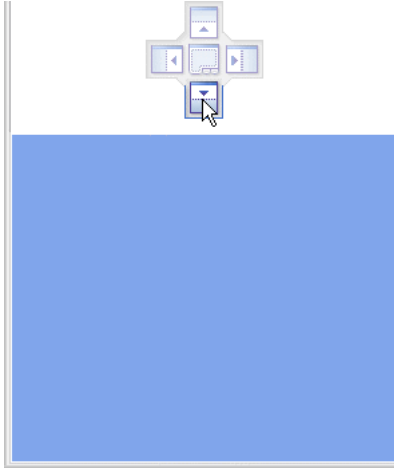



Step 4: To dock the window in the position indicated, release the mouse button.

Tip : To move a dockable window without snapping it into place, press CTRL while dragging it.

Saving Layout

Once you have a window layout that you like, you can save the layout by typing the name for the layout and pressing the Save Layout Icon .

To set the layout select the desired layout from the layout drop-down list and click the Set Layout Icon .

To remove the layout from the drop-down list, select the desired layout from the list and click the Delete Layout Icon .

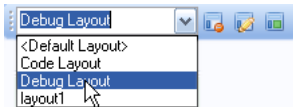

Auto Hide

Auto Hide enables you to see more of your code at one time by minimizing tool windows along the edges of the IDE when not in use.

- Click the window you want to keep visible to give it focus.
- Click the Pushpin Icon  on the title bar of the window.

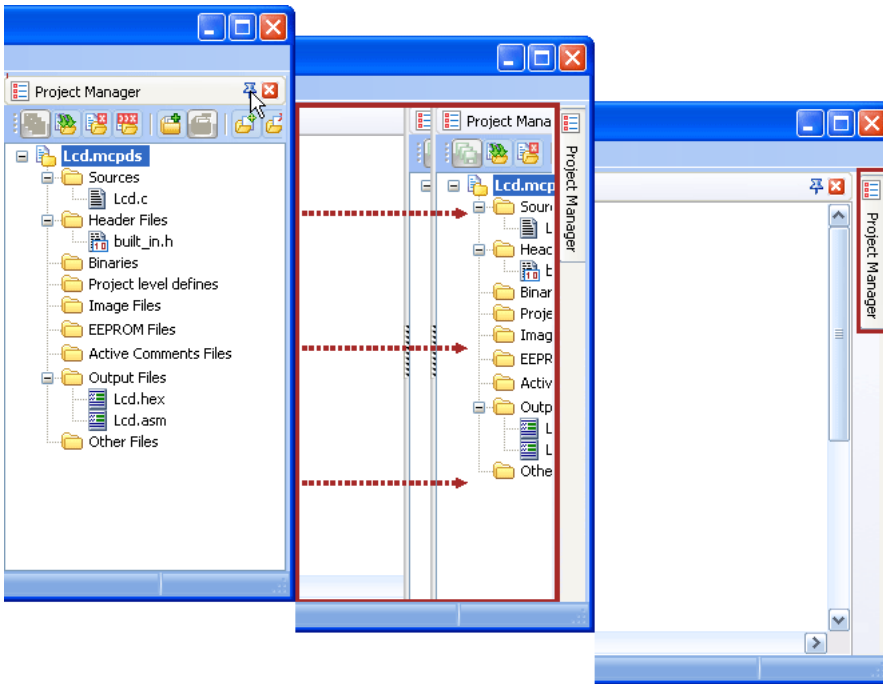

When an auto-hidden window loses focus, it automatically slides back to its tab on the edge of the IDE. While a window is auto-hidden, its name and icon are visible on a tab at the edge of the IDE. To display an auto-hidden window, move your pointer over the tab. The window slides back into view and is ready for use.

Options

Options menu consists of three tabs: Code Editor, Tools and Output settings

Code editor

The Code Editor is advanced text editor fashioned to satisfy needs of professionals.

Tools

The mikroC PRO for dsPIC30/33 and PIC24 includes the Tools tab, which enables the use of shortcuts to external programs, like Calculator or Notepad.

You can set up to 10 different shortcuts, by editing Tool0 - Tool9.

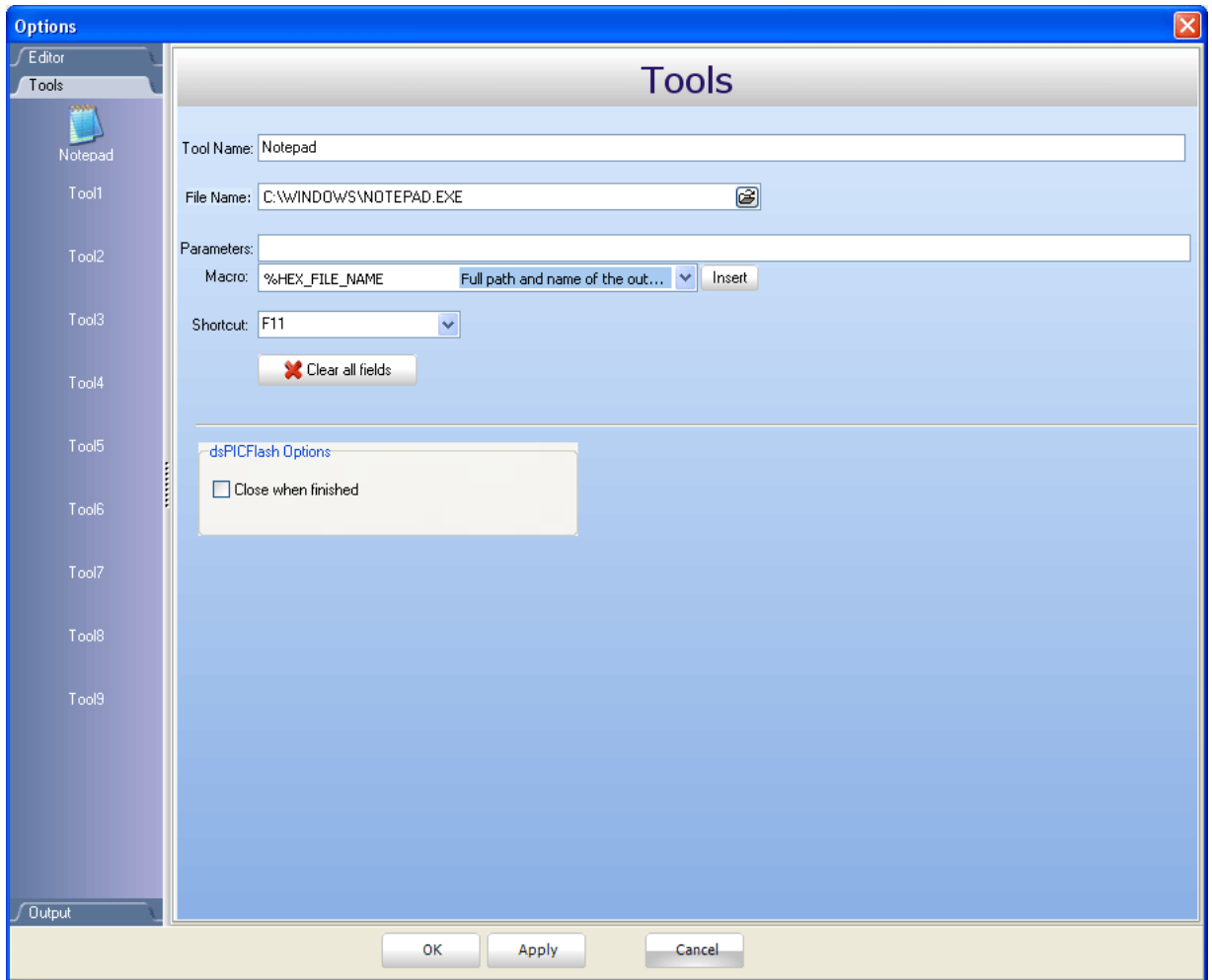

Output settings

By modifying Output Settings, user can configure the content of the output files. You can enable or disable, for example, generation of ASM and List file.

Also, user can choose optimization level, and compiler specific settings, which include case sensitivity, dynamic link for string literals setting (described in mikroC PRO for dsPIC30/33 and PIC24 specifics).

Build all files as library enables user to use compiled library (*.mcl) on any MCU (when this box is checked), or for a selected MCU (when this box is left unchecked).

For more information on creating new libraries, see Creating New Library.

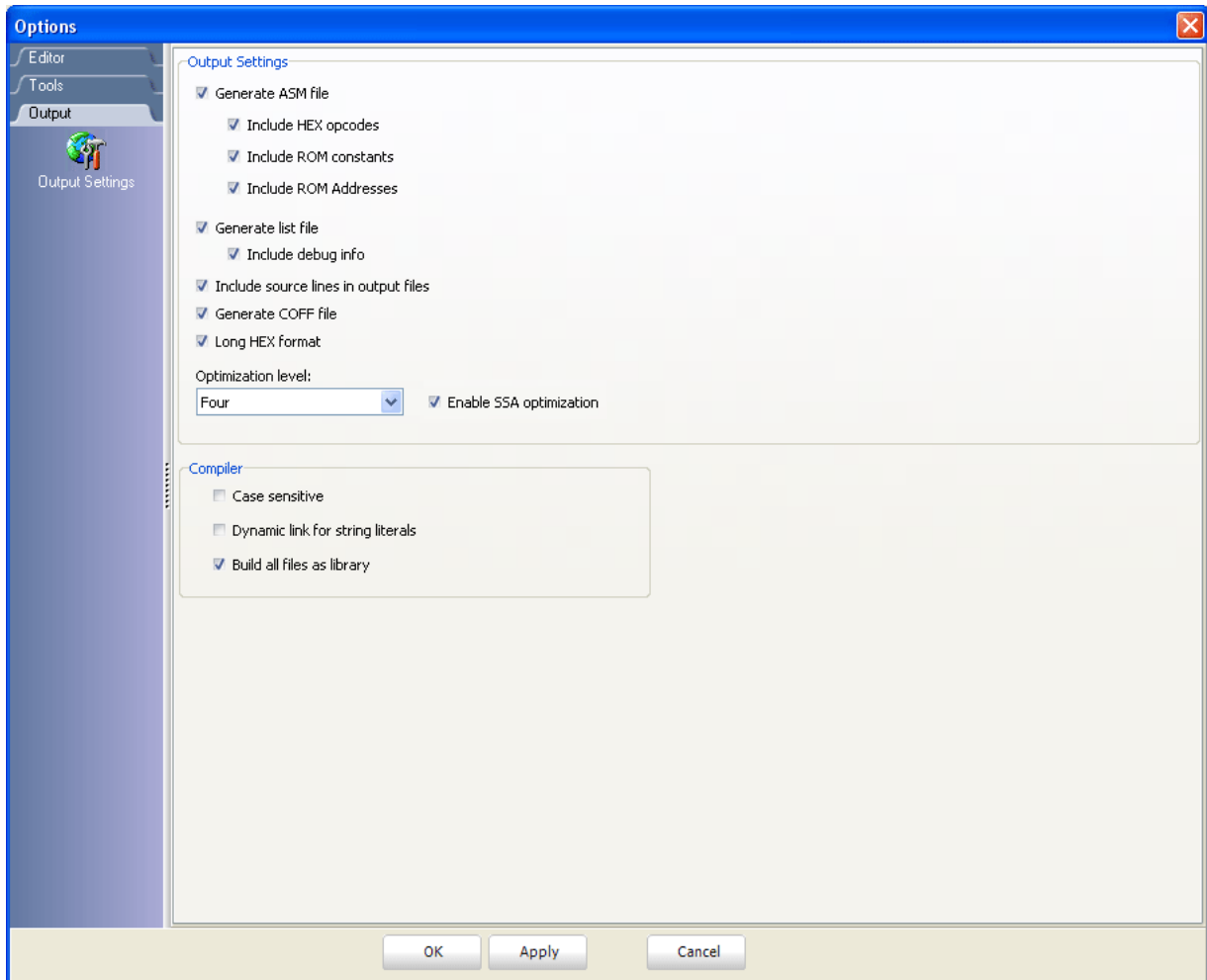

Integrated Tools

Active Comments Editor

Active Comments Editor is a tool, particularly useful when working with Lcd display. You can launch it from the drop-down menu **Tools > Active Comments Editor** or by clicking the Active Comment Editor Icon  from Tools toolbar.

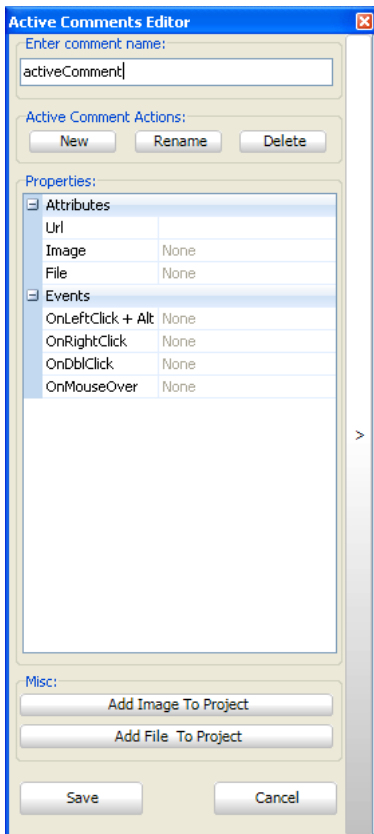

ASCII Chart

The ASCII Chart is a handy tool, particularly useful when working with Lcd display. You can launch it from the drop-down menu **Tools > ASCII chart** or by clicking the View ASCII Chart Icon  from Tools toolbar.

	0	1	2	3	4	5	6	7	8	9	A	B	C	D	E	F
0	NUL	SOH	STX	ETX	EOT	ENQ	ACK	BEL	BS	HT	LF	VT	FF	CR	SO	SI
1	DLE	DC1	DC2	DC3	DC4	NAK	SYN	ETB	CAN	EM	SUB	ESC	FS	GS	RS	US
2	SPC	!	"	#	\$	%	&	'	()	*	+	,	-	.	/
3	0	1	2	3	4	5	6	7	8	9	:	;	<	=	>	?
4	@	A	B	C	D	E	F	G	H	I	J	K	L	M	N	O
5	P	Q	R	S	T	U	V	W	X	Y	Z	[\]	^	_
6	`	a	b	c	d	e	f	g	h	i	j	k	l	m	n	o
7	p	q	r	s	t	u	v	w	x	y	z	{		}	~	DEL
8	€	□	,	f	„	…	†	°	š	<	œ	□	ž	□		
9	□	'	'	"	•	-	-	~	™	š	>	œ	□	ž	Ÿ	
A	i	φ	£	π	¥	!	§	"	©	a	«	¬	-	®	-	
B	°	±	²	³	´	µ	¶	·	¸	¹	º	»	¼	½	¾	¿
C	À	Á	Â	Ã	Ä	Å	Æ	Ç	È	É	Ê	Ë	Ì	Í	Î	Ï
D	Ð	Ñ	Ò	Ó	Ô	Õ	Ö	×	Ø	Ù	Ú	Û	Ü	Ý	Þ	ß
E	à	á	â	ã	ä	å	æ	ç	è	é	ê	ë	ì	í	î	ï
F	ð	ñ	ò	ó	ô	õ	ö	÷	ø	ù	ú	û	ü	ý	þ	ÿ

EEPROM Editor

The EEPROM Editor is used for manipulating MCU's EEPROM memory. You can launch it from the drop-down menu **Tools** > **EEPROM Editor**.

When you run mikroElektronika programmer software from mikroC PRO for dsPIC30/33 and PIC24 IDE - `project_name.hex` file will be loaded automatically while ihex file must be loaded manually.

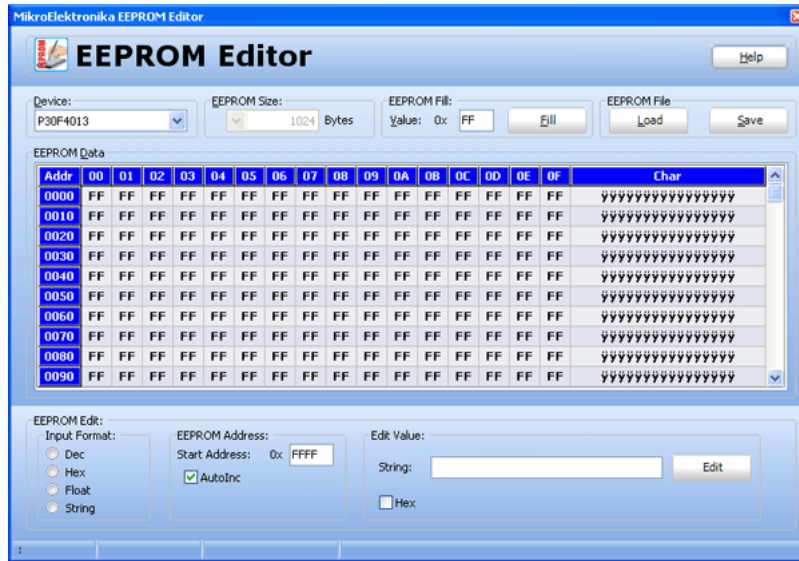

Filter Designer

The Filter designer is a tool for designing FIR and IIR filters. It has an user-friendly visual interface for setting the filter parameters. Filter designer output is the mikroC PRO for dsPIC30/33 and PIC24 compatible code. You can launch it from the drop-down menu **Tools** > **Filter Designer**.

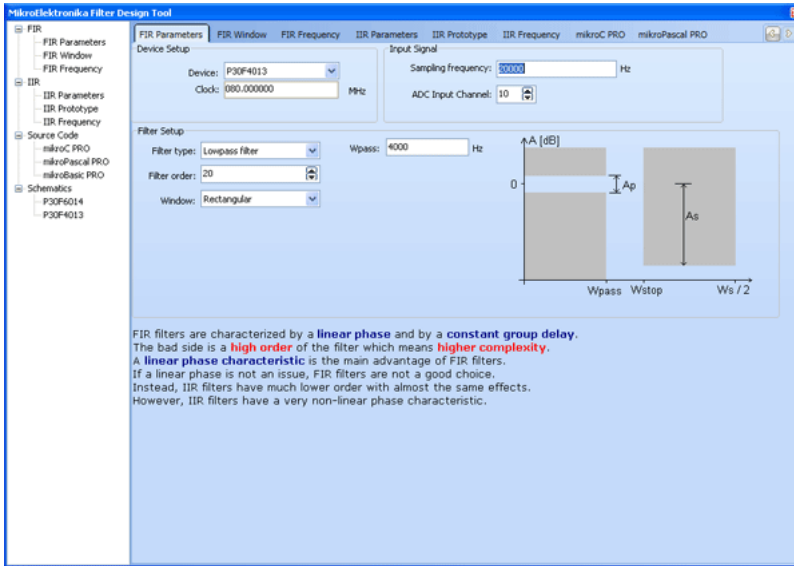

Graphic Lcd Bitmap Editor

The mikroC PRO for dsPIC30/33 and PIC24 includes the Graphic Lcd Bitmap Editor. Output is the mikroC PRO for dsPIC30/33 and PIC24 compatible code. You can launch it from the drop-down menu **Tools** > **Glcd Bitmap Editor**.

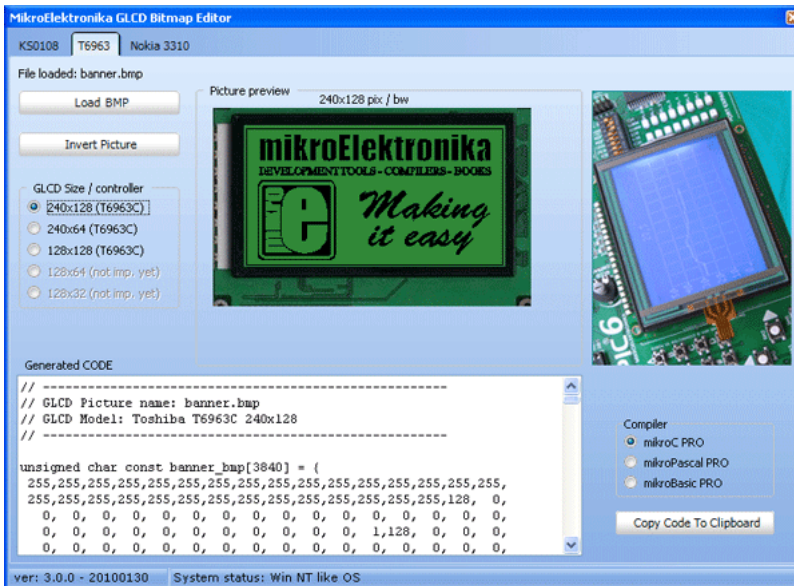

HID Terminal

The mikroC PRO for dsPIC30/33 and PIC24 includes the HID communication terminal for USB communication. You can launch it from the drop-down menu **Tools > HID Terminal**.

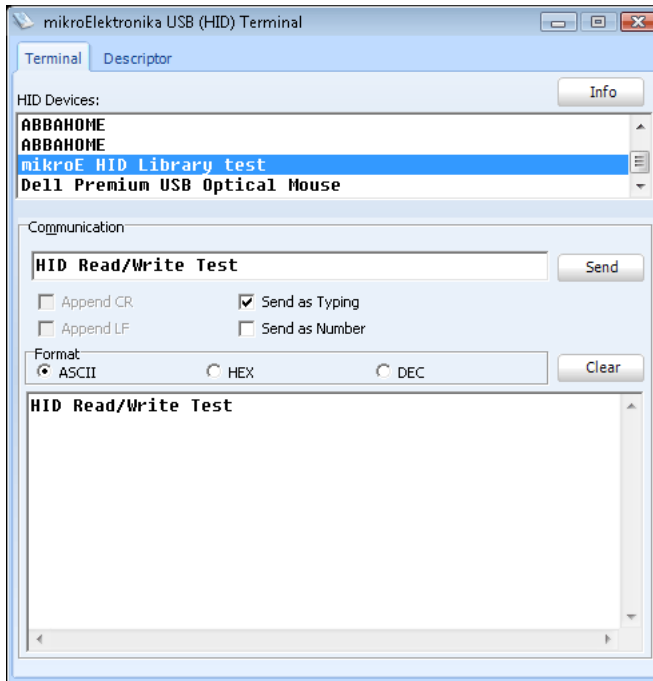

Lcd Custom Character

mikoC PRO for dsPIC30/33 and PIC24 includes the Lcd Custom Character. Output is mikroC PRO for dsPIC30/33 and PIC24 compatible code. You can launch it from the drop-down menu **Tools > Lcd Custom Character**.

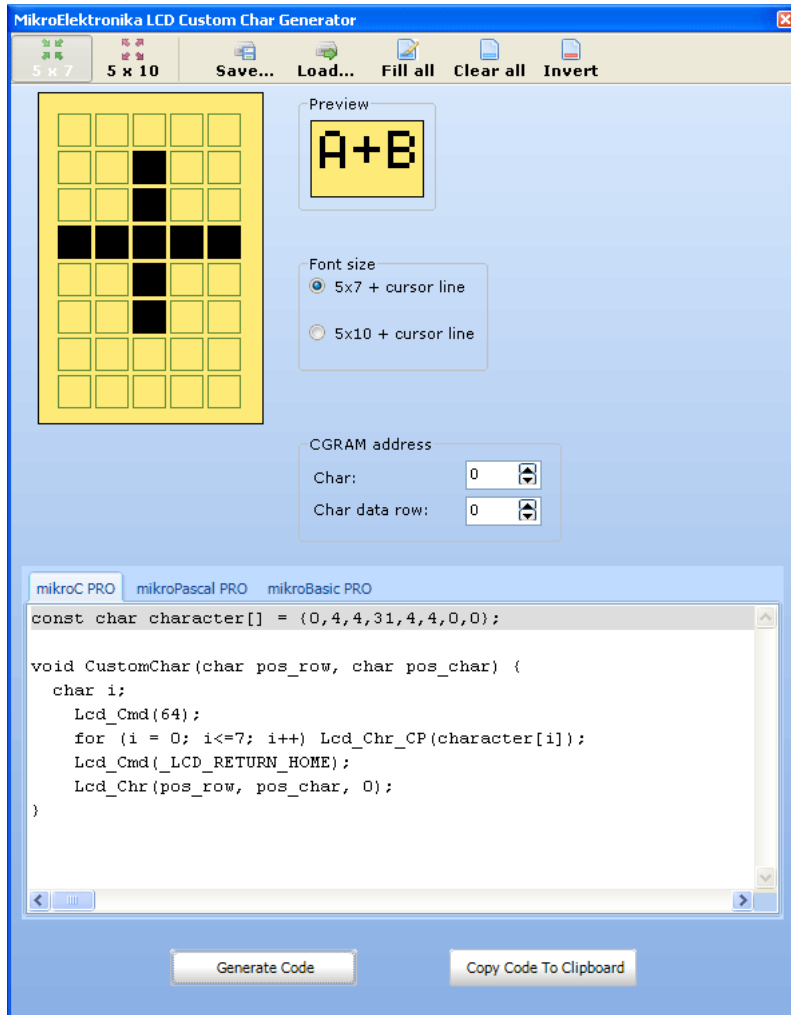

Seven Segment Editor

The Seven Segment Editor is a convenient visual panel which returns decimal/hex value for any viable combination you would like to display on seven segment display. Click on the parts of seven segment image to get the requested value in the edit boxes. You can launch it from the drop-down menu **Tools > Seven Segment Editor** or by clicking the Seven Segment Editor Icon  from Tools toolbar.

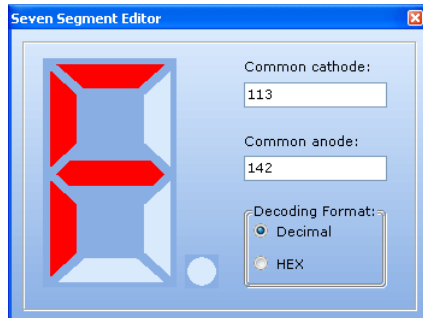

UDP Terminal

The mikroC PRO for dsPIC30/33 and PIC24 includes the UDP Terminal. You can launch it from the drop-down menu **Tools > UDP Terminal**.

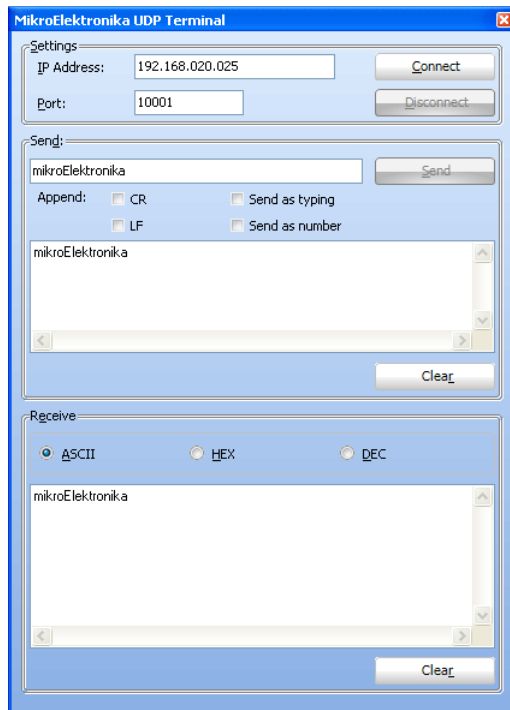

USART Terminal

The mikroC PRO for dsPIC30/33 and PIC24 includes the USART communication terminal for RS232 communication. You can launch it from the drop-down menu **Tools** > **USART Terminal** or by clicking the USART Terminal Icon  from Tools toolbar.

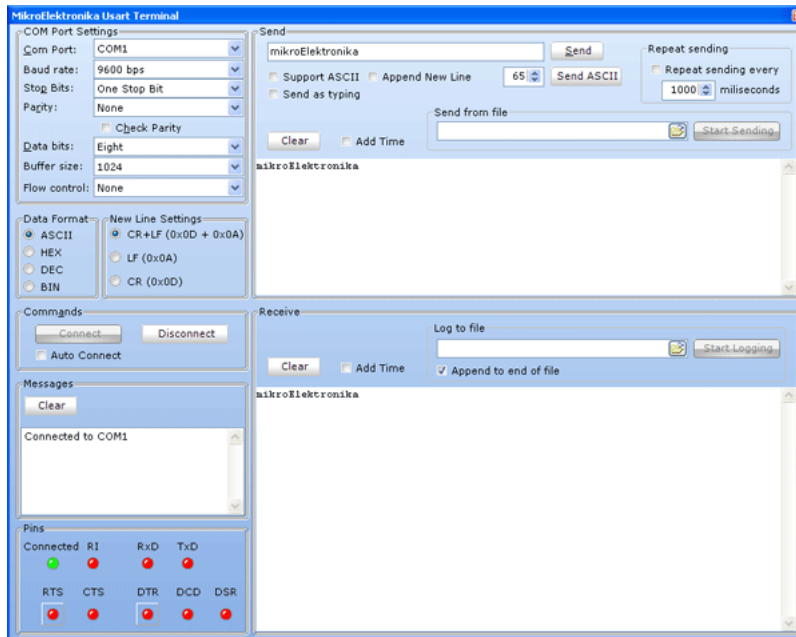

Active Comments

The idea of Active Comments is to make comments alive and give old fashioned comments new meaning and look. From now on, you can assign mouse event on your comments and 'tell' your comments what to do on each one. For example, on left mouse click, open some web address in your browser, on mouse over show some picture and on mouse double click open some file.

Let suppose we are writing an example for a GSM/GPSR module which is connected to EasyPIC6 and we would like to provide a photo of our hardware (jumpers, cables, etc.) within the example. Also, it would be also nice to put some documentation about chip we are using and a GSM module extra board. Now we can have all those things defined in one single comment using **Active Comment Editor**.

New Active Comment

When you start Active Comment Editor for the first time (from the View menu, from editor's pop-up menu, or by pressing Ctrl + Alt + P) you will get an empty editor :

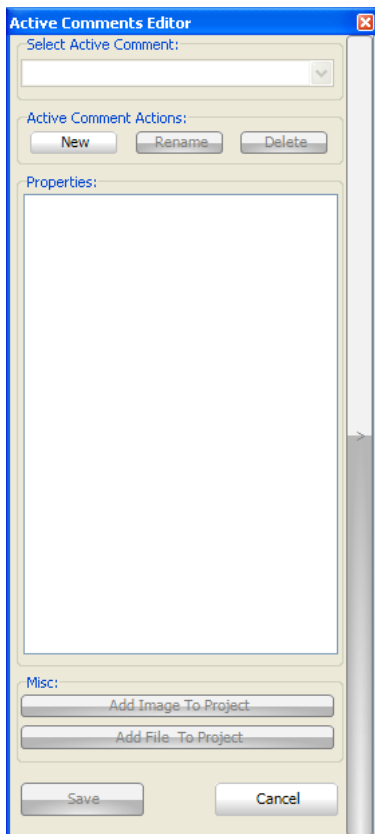

By clicking the  button you are prompted to enter a name for the comment :

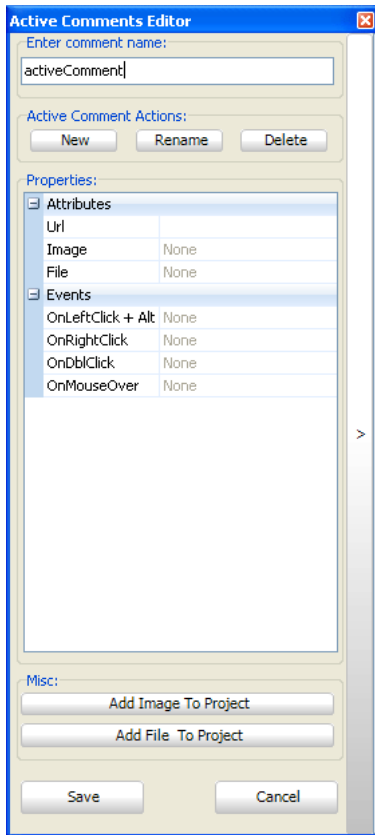

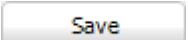
You can notice that when you start typing a name, properties pane is automatically displayed so you can edit properties if you wish. A Comment will be created when you click  button.

Properties are consisted of two major categories - Attributes and Events.

Attributes can be :

- URL - Valid web address.
- Image - Image has to be previously added to Project (Project Manager > Images).
- File - File has to be previously added to Project (Project Manager > Other Files).

There are four predefined event types you can apply to an Active Comment :

1. OnLeftClick + Alt
2. OnRightClick
3. OnDoubleClick
4. OnMouseOver

First three event types can have one of the following three actions :

1. OpenUrl - Opens entered URL in default Web browser.
2. OpenFile - Opens a file within a default program associated with the file extension (defined by Windows).
3. None - Does nothing.

Fourth event, OnMouseOver, has only 2 actions :

1. PreviewImage - Shows image when cursor is moved over a comment.
2. None - Does nothing.

Attributes are tightly bounded with events. For example, you can not have OnLeftClick + Alt -> OpenFile if there is no file attribute set, or if there is no file added to project. Same behavior applies to image attribute.

Let's start editing our Active Comment by entering some valid web address in the URL field :

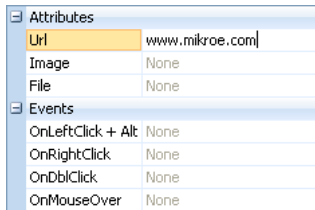

For every Active Comment a XML file will be created, containing all valid information regarding the Active Comment - attributes, events, etc. and it is automatically added to Project manager after saving it :

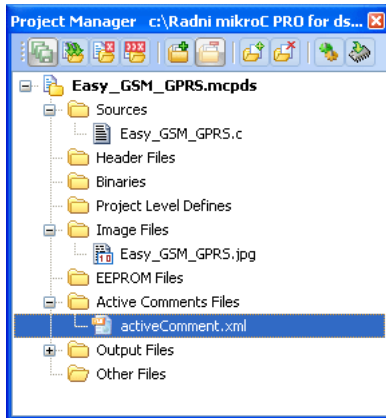

You can see the contents of the created XML file by expanding Active Comment Editor :

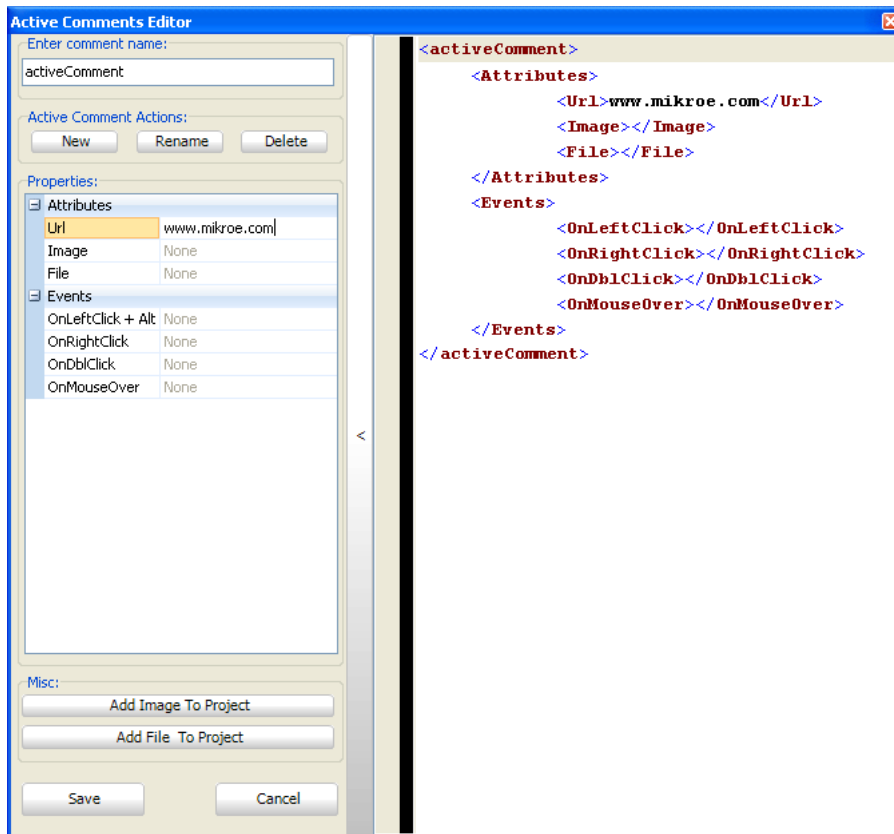

As we mentioned above you can add image or file which are already included in project. If the the desired image or file aren't added, you can do it directly from here by clicking the or button.

Next file dialog will be opened :

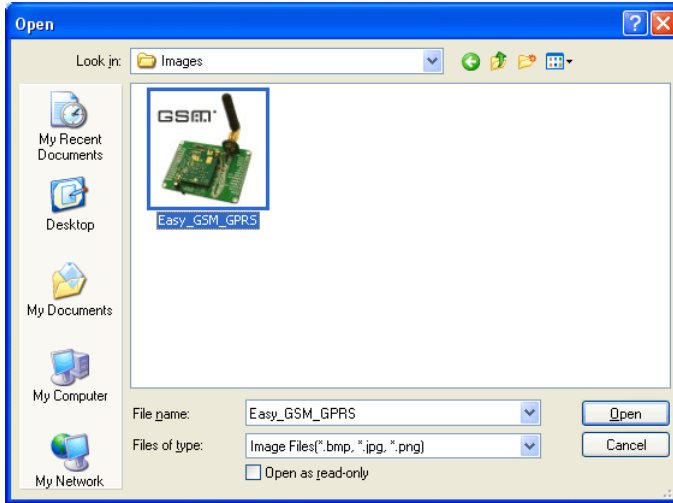

There, you should select the desired image to be added. In our example, Easy_GSM_GPRS.jpg image will be added.

Selected picture is automatically added to the drop down list of the Image field in Active Comment Editor :

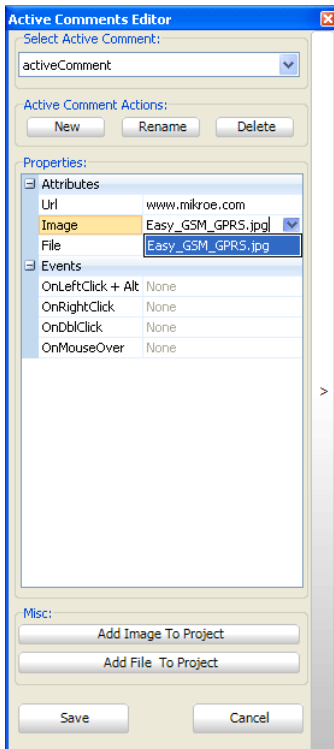

Now, when image has been selected, we can assign an event for it. For example, OnMouseOver will be used for PreviewImage action, and OnLeftClick + Alt will be assigned to OpenUrl action :

Attributes	
Url	www.mikroe.com
Image	Easy_GSM_GPRS.jpg
File	None
Events	
OnLeftClick + Alt	OpenUrl
OnRightClick	None
OnDbClick	None
OnMouseOver	PreviewImage

Now we can save our changes to Active Comment by clicking the Save button.

Note : Setting file attributes is same as for image, so it won't be explained separately.

Once we have finished creating our active comment, we can notice that it has been added to source file on current caret position with ac: prefix 'telling' IDE that it is active comment :

```

30 // ac:activeComment

```

Now let's try it. If you LeftClick+Alt on it, URL in default Web browser will be opened. If you hover the mouse over it, you will see an Image preview:



There is another way to add an active comment to an active project. You can do it simply by typing a comment in old fashion way, except with ac: prefix. So it would look like this :

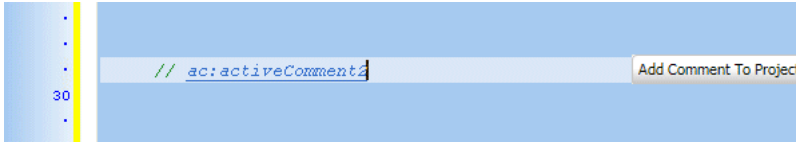

Notice that when you stop typing, Add Comment To Project button will show. By clicking on it, you will open Active Comment Editor and comment name will be already set, so you need only to adjust attributes and settings. After saving you can always edit your active comment by Active Comment Editor, and switch between comments directly from editor.

If you remove a file from the Project Manager or add an Active Comment File which contains information about the file which is no longer in project, and hover the mouse over the comment, you will be prompted to either add file to project or remove event definition from Active Comment for this file :

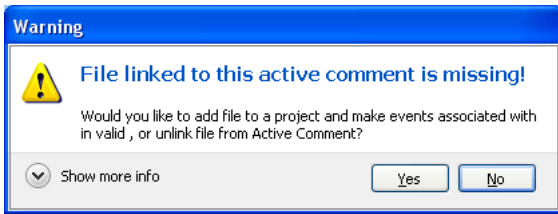

If you remove active comment file from the Project Manager, you'll receive this message:

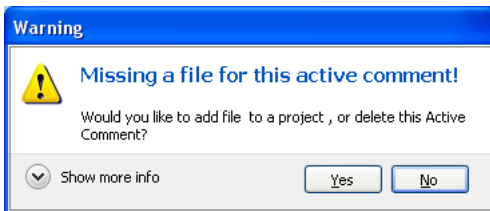

Click on Yes button you'll prompted for an active comment file :

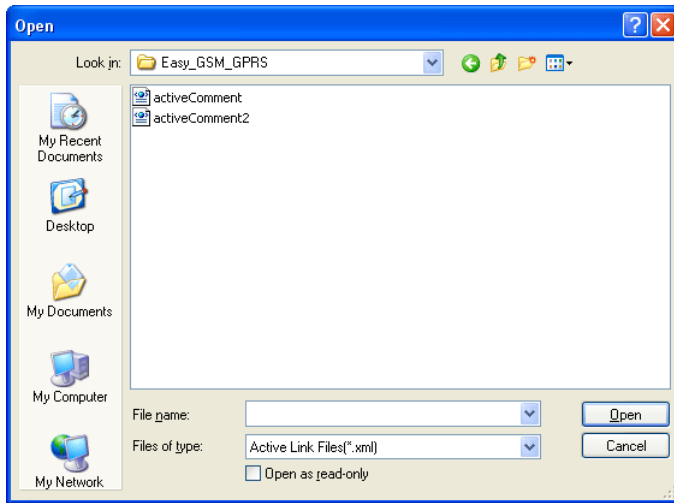

If you click No, comment will be removed from the source code.

Renaming Active Comment

When you click on rename button, you will be prompted to enter new name :

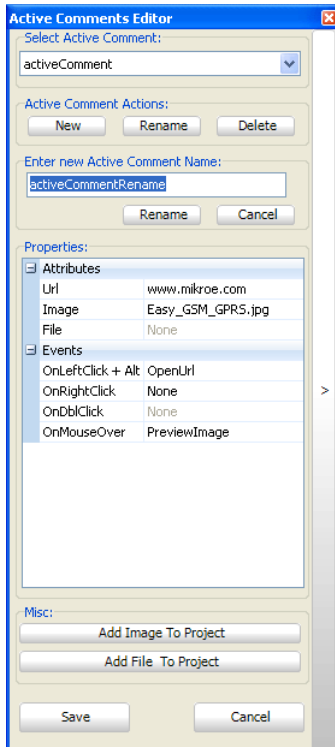

Now click again Rename button. Now you have renamed your Active Comment in such a way that its filename, source code name are changed :

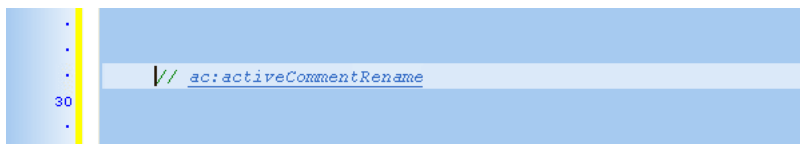

```
.  
. 30  
.  // ac:activeCommentRename
```

Deleting Active Comment

Deleting active comment works similar like renaming it. By clicking on delete button, you will remove an active comment from both code and Project Manager.

Export Project

This option is very convenient and finds its use in relocating your projects from one place to another (e.g. from your work computer to your home computer).

Often, project contains complicated search paths (files involved within your project could be in a different folders, even on different hard disks), so it is very likely that some files will be forgotten during manual relocation. In order to simplify this, Export Project gives you opportunity to do this task automatically.

To open Export Project, from Project menu select Export Project or hit Ctrl + Alt + E. Following window will appear :

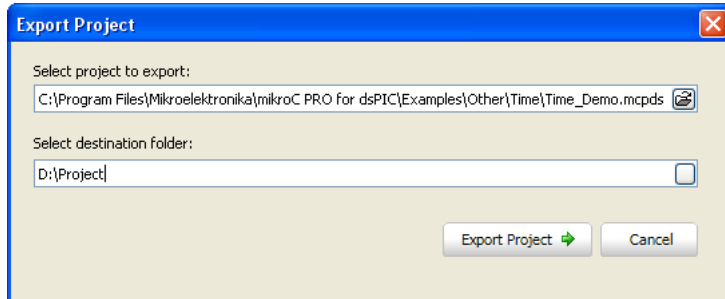

In the empty input boxes, current location and the destination folder of the desired project should be entered.

By default, currently active project will be set for export. You can change it any time by clicking the Open Button  .

Once you have entered the appropriate data, click Export Project button. After exporting is done, and if everything was OK, you'll receive a message :

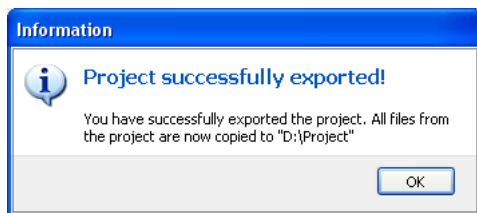

Now, Export Project has copied all project files into desired folder and changed project search paths, so you can easily move the entire folder to another location and run the project.

Jump To Interrupt

Lets you choose which interrupt you want to jump to.

Requirement: Interrupt routine is included in project.

You can call Jump To Interrupt by selecting **Run > Jump To Interrupt** from the drop-down menu, or by clicking the Jump To Interrupt Icon , from the Watch Values Window.

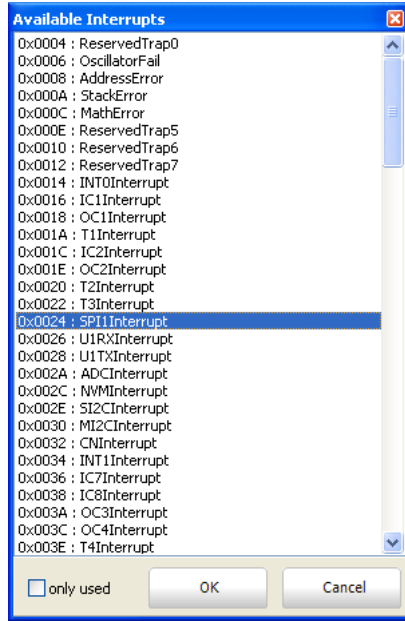

By checking the Only Used box, you can display only the used breakpoints.

Regular Expressions

Introduction

Regular Expressions are a widely-used method of specifying patterns of text to search for. Special metacharacters allow you to specify, for instance, that a particular string you are looking for, occurs at the beginning, or end of a line, or contains `n` recurrences of a certain character.

Simple matches

Any single character matches itself, unless it is a metacharacter with a special meaning described below. A series of characters matches that series of characters in the target string, so the pattern `"short"` would match `"short"` in the target string. You can cause characters that normally function as metacharacters or escape sequences to be interpreted by preceding them with a backslash `"\"`.

For instance, metacharacter `"^"` matches beginning of string, but `"\^"` matches character `"^"`, and `"\"` matches `"\"`, etc.

Examples :

```
unsigned matches string 'unsigned'
\^unsigned matches string '^unsigned'
```

Escape sequences

Characters may be specified using a escape sequences: `"\n"` matches a newline, `"\t"` a tab, etc. More generally, `\xnn`, where `nn` is a string of hexadecimal digits, matches the character whose ASCII value is `nn`.

If you need wide (Unicode) character code, you can use `\x{nnnn}`, where `'nnnn'` - one or more hexadecimal digits.

```
\xnn - char with hex code nn
\x{nnnn} - char with hex code nnnn (one byte for plain text and two bytes for Unicode)
\t - tab (HT/TAB), same as \x09
\n - newline (NL), same as \x0a
\r - car.return (CR), same as \x0d
\f - form feed (FF), same as \x0c
\a - alarm (bell) (BEL), same as \x07
\e - escape (ESC) , same as \x1b
```

Examples:

```
unsigned\x20int matches 'unsigned int' (note space in the middle)
\tunsigned matches 'unsigned' (predecessed by tab)
```

Character classes

You can specify a character class, by enclosing a list of characters in `[]`, which will match any of the characters from the list. If the first character after the `"["` is `"^"`, the class matches any character not in the list.

Examples:

`count[aeiou]r` finds strings 'countar', 'counter', etc. but not 'countbr', 'countcr', etc.
`count[^aeiou]r` finds strings 'countbr', 'countcr', etc. but not 'countar', 'counter', etc.

Within a list, the "-" character is used to specify a range, so that `a-z` represents all characters between "a" and "z", inclusive.

If you want "-" itself to be a member of a class, put it at the start or end of the list, or precede it with a backslash. If you want ']', you may place it at the start of list or precede it with a backslash.

Examples:

`[-az]` matches 'a', 'z' and '-'
`[az-]` matches 'a', 'z' and '-'
`[a\^-z]` matches 'a', 'z' and '-'
`[a-z]` matches all twenty six small characters from 'a' to 'z'
`[\n-\x0D]` matches any of #10, #11, #12, #13.
`[\d-t]` matches any digit, '-' or 't'.
`[]-a]` matches any char from ']'..'a'.

Metacharacters

Metacharacters are special characters which are the essence of regular expressions. There are different types of metacharacters, described below.

Metacharacters - Line separators

`^` - start of line
`$` - end of line
`\A` - start of text
`\Z` - end of text
`.` - any character in line

Examples:

`^PORTA` - matches string 'PORTA' only if it's at the beginning of line
`PORTA$` - matches string 'PORTA' only if it's at the end of line
`^PORTA$` - matches string 'PORTA' only if it's the only string in line
`PORT.r` - matches strings like 'PORTA', 'PORTB', 'PORT1' and so on

The `^` metacharacter by default is only guaranteed to match beginning of the input string/text, and the `$` metacharacter only at the end. Embedded line separators will not be matched by `^` or `$`.

You may, however, wish to treat a string as a multi-line buffer, such that the `^` will match after any line separator within the string, and `$` will match before any line separator.

Regular expressions works with line separators as recommended at <http://www.unicode.org/unicode/reports/tr18/>

Metacharacters - Predefined classes

`\w` - an alphanumeric character (including "`_`")
`\W` - a nonalphanumeric character
`\d` - a numeric character
`\D` - a non-numeric character
`\s` - any space (same as `[\t\n\r\f]`)
`\S` - a non space

You may use `\w`, `\d` and `\s` within custom character classes.

Example:

`routi\de` - matches strings like `' routi le'`, `' routi6e'` and so on, but not `' routine'`, `' routime'` and so on.

Metacharacters - Word boundaries

A word boundary ("`\b`") is a spot between two characters that has an alphanumeric character ("`\w`") on one side, and a nonalphanumeric character ("`\W`") on the other side (in either order), counting the imaginary characters off the beginning and end of the string as matching a "`\W`".

`\b` - match a word boundary
`\B` - match a non-(word boundary)

Metacharacters - Iterators

Any item of a regular expression may be followed by another type of metacharacters - iterators. Using this metacharacters, you can specify number of occurrences of previous character, metacharacter or subexpression.

`*` - zero or more ("greedy"), similar to `{0,}`
`+` - one or more ("greedy"), similar to `{1,}`
`?` - zero or one ("greedy"), similar to `{0,1}`
`{n}` - exactly n times ("greedy")
`{n,}` - at least n times ("greedy")
`{n,m}` - at least n but not more than m times ("greedy")
`*?` - zero or more ("non-greedy"), similar to `{0,}?`
`++?` - one or more ("non-greedy"), similar to `{1,}?`
`??` - zero or one ("non-greedy"), similar to `{0,1}?`
`{n}?` - exactly n times ("non-greedy")
`{n,}?` - at least n times ("non-greedy")
`{n,m}?` - at least n but not more than m times ("non-greedy")

So, digits in curly brackets of the form, `{n,m}`, specify the minimum number of times to match the item `n` and the maximum `m`. The form `{n}` is equivalent to `{n,n}` and matches exactly `n` times. The form `{n,}` matches `n` or more times. There is no limit to the size of `n` or `m`, but large numbers will chew up more memory and slow down execution.

If a curly bracket occurs in any other context, it is treated as a regular character.

Examples:

```
count.*r - matches strings like 'counter', 'countelkjdfk9r' and 'countr'
count.+r - matches strings like 'counter', 'countelkjdfk9r' but not 'countr'
count.?r - matches strings like 'counter', 'countar' and 'countr' but not 'countelkj9r'
counte{2}r - matches string 'counteer'
counte{2,}r - matches strings like 'counteer', 'counteeer', 'counteeer' etc.
counte{2,3}r - matches strings like 'counteer', or 'counteeer' but not 'counteeeer'
```

A little explanation about "greediness". "Greedy" takes as many as possible, "non-greedy" takes as few as possible. For example, 'b+' and 'b*' applied to string 'abbbbc' return 'bbbbc', 'b+?' returns 'b', 'b*?' returns empty string, 'b{2,3}?' returns 'bb', 'b{2,3}' returns 'bbb'.

Metacharacters - Alternatives

You can specify a series of alternatives for a pattern using "|" to separate them, so that `bit|bat|bot` will match any of "bit", "bat", or "bot" in the target string as would `b(i|a|o)t`. The first alternative includes everything from the last pattern delimiter ("(", "[", or the beginning of the pattern) up to the first "|", and the last alternative contains everything from the last "|" to the next pattern delimiter. For this reason, it's common practice to include alternatives in parentheses, to minimize confusion about where they start and end.

Alternatives are tried from left to right, so the first alternative found for which the entire expression matches, is the one that is chosen. This means that alternatives are not necessarily greedy. For example: when matching `rou|route` against "routine", only the "rou" part will match, as that is the first alternative tried, and it successfully matches the target string (this might not seem important, but it is important when you are capturing matched text using parentheses.) Also remember that "|" is interpreted as a literal within square brackets, so if you write `[bit|bat|bot]`, you're really only matching `[biao|]`.

Examples:

```
rou(tine|te) - matches strings 'routine' or 'route'.
```

Metacharacters - Subexpressions

The bracketing construct (...) may also be used to define regular subexpressions. Subexpressions are numbered based on the left to right order of their opening parenthesis. First subexpression has number '1'

Examples:

```
(int){8,10} matches strings which contain 8, 9 or 10 instances of the 'int'
routi([0-9]|a+)e matches 'routi0e', 'routile', 'routine', 'routinne', 'routinnne' etc.
```

Metacharacters - Backreferences

Metacharacters `\1` through `\9` are interpreted as backreferences. `\` matches previously matched subexpression #.

Examples:

```
(.)\1+ matches 'aaaa' and 'cc'.
(.+)\1+ matches 'abab' and '123123'
(["']?) (\d+)\1 matches "13" (in double quotes), or '4' (in single quotes) or 77 (without quotes) etc
```

Keyboard Shortcuts

Below is a complete list of keyboard shortcuts available in mikroC PRO for dsPIC30/33 and PIC24 IDE.

IDE Shortcuts	
F1	Help
Ctrl+N	New Unit
Ctrl+O	Open
Ctrl+Shift+O	Open Project
Ctrl+Shift+N	New Project
Ctrl+K	Close Project
Ctrl+F4	Close unit
Ctrl+Shift+E	Edit Project
Ctrl+F9	Build
Shift+F9	Build All
Ctrl+F11	Build And Program
Shift+F4	View Breakpoints
Ctrl+Shift+F5	Clear Breakpoints
F11	Start mE Programmer
Ctrl+Shift+F11	Project Manager
F12	Options
Alt + X	Close mikroC PRO for dsPIC30/33 and PIC24
Basic Editor Shortcuts	
F3	Find, Find Next
Shift+F3	Find Previous
Alt+F3	Grep Search, Find In Files
Ctrl+A	Select All
Ctrl+C	Copy
Ctrl+F	Find
Ctrl+R	Replace
Ctrl+P	Print
Ctrl+S	Save Unit
Ctrl+Shift+S	Save All
Ctrl+V	Paste
Ctrl+X	Cut
Ctrl+Y	Delete Entire Line
Ctrl+Z	Undo
Ctrl+Shift+Z	Redo

Advanced Editor Shortcuts	
Ctrl+Space	Code Assistant
Ctrl+Shift+Space	Parameters Assistant
Ctrl+D	Find Declaration
Ctrl+E	Incremental Search
Ctrl+L	Routine List
Ctrl+G	Goto Line
Ctrl+J	Insert Code Template
Ctrl+Shift+.	Comment Code
Ctrl+Shift+,	Uncomment Code
Ctrl+ <i>number</i>	Goto Bookmark
Ctrl+Shift+ <i>number</i>	Set Bookmark
Ctrl+Shift+I	Indent Selection
Ctrl+Shift+U	Unindent Selection
TAB	Indent Selection
Shift+TAB	Unindent Selection
Alt+Select	Select Columns
Ctrl+Alt+Select	Select Columns
Alt + Left Arrow	Fold Region (if available)
Alt + Right Arrow	Unfold Region (if available)
Ctrl+Alt+L	Convert Selection to Lowercase
Ctrl+Alt+U	Convert Selection to Uppercase
Ctrl+Alt+T	Convert to Titlecase
Ctrl+T	USART Terminal
Ctrl+Q	Quick Converter
mikroICD Debugger and Software Simulator Shortcuts	
F2	Jump To Interrupt
F4	Run to Cursor
F5	Toggle Breakpoint
F6	Run/Pause Debugger
F7	Step Into
F8	Step Over
F9	Start Debugger
Ctrl+F2	Stop Debugger

Ctrl+F5	Add to Watch List
Ctrl+F8	Step Out
Alt+D	Disassembly View
Shift+F5	Open Watch Window
Ctrl+Shift+A	Show Advanced Breakpoints

CHAPTER 3

mikoC PRO for dsPIC30/33 and PIC24 Command Line Options

Usage: `mikroCdsPIC.exe` [-<opts> [-<opts>]] [<infile> [-<opts>]] [-<opts>]]
 Infile can be of *.c, *.mcl and *.pld type.

The following parameters are valid :

- P <devicename> : MCU for which compilation will be done.
- FO <oscillator> : Set oscillator [in MHz].
- SP <directory> : Add directory to the search path list.
- IP <directory> : Add directory to the #include search path list.
- N <filename> : Output files generated to file path specified by filename.
- B <directory> : Save compiled binary files (*.mcl) to 'directory'.
- O : Miscellaneous output options.
- DBG : Generate debug info.
- L : Check and rebuild new libraries.
- DL : Build all files as libraries.
- Y : Dynamic link for string literals.
- UICD : ICD build type.
- EH <filename> : Full EEPROM HEX file name with path.
- LHF : Generate Long hex format.
- GC : Generate COFF file.

Example:

```
mikroCdsPIC.exe -MSF -DBG -p30F4013 -Y -DL -O11111114 -fo80 -N"C:\Lcd\Lcd.mcpds" -SP"C:\
Program Files\Mikroelektronika\mikroC PRO for dsPIC\Defs"
-SP"C:\Program Files\Mikroelektronika\mikroC PRO for dsPIC\Uses" -SP"C:\
Lcd\" "Lcd.c" "__Lib_Math.mcl" "__Lib_MathDouble.mcl"
 "__Lib_System.mcl" "__Lib_Delays.mcl" "__Lib_LcdConsts.mcl" "__Lib_Lcd.
mcl"
```

Parameters used in the example:

```
-MSF : Short Message Format; used for internal purposes by IDE.
-DBG : Generate debug info.
-p30F4013 : MCU 30F4013 selected.
-Y : Dynamic link for string literals enabled.
-DL : All files built as libraries.
-O111111114 : Miscellaneous output options.
-fo80 : Set oscillator frequency [in MHz].
-N"C:\Lcd\Lcd.mcpds" -SP"C:\Program Files\Mikroelektronika\mikroC PRO for dsPIC\
Defs\" : Output files generated to file path specified by filename.
-SP"C:\Program Files\Mikroelektronika\mikroC PRO for dsPIC\Defs\" : Add directory to
the search path list.
-SP"C:\Program Files\Mikroelektronika\mikroC PRO for dsPIC\Uses\" : Add directory to
the search path list.
-SP"C:\Lcd\" : Add directory to the search path list.
"Lcd.c" "__Lib_Math.mcl" "__Lib_MathDouble.mcl" "__Lib_System.mcl" "__Lib_Delays.
mcl" "__Lib_LcdConsts.mcl" "__Lib_Lcd.mcl" : Specify input files.
```

CHAPTER 4

mikroCD (In-Circuit Debugger)

Introduction

The mikroCD is a highly effective tool for a **Real-Time debugging** on hardware level. The mikroCD debugger enables you to execute the mikroC PRO for dsPIC30/33 and PIC24 program on a host dsPIC30/33 or PIC24 microcontroller and view variable values, Special Function Registers (SFR), RAM, CODE and EEPROM memory along with the mikroCD code execution on hardware.

Step No. 1

If you have appropriate hardware and software for using the mikroICD select mikroICD Debug Build Type before compiling the project.

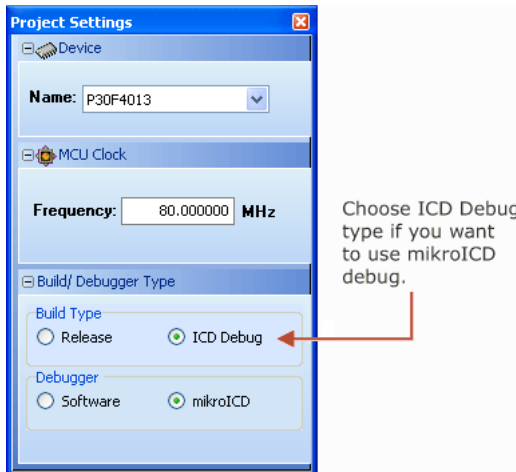

Now, compile the project by pressing Ctrl + F9, or by pressing Build Icon  on Build Toolbar.

Step No. 2



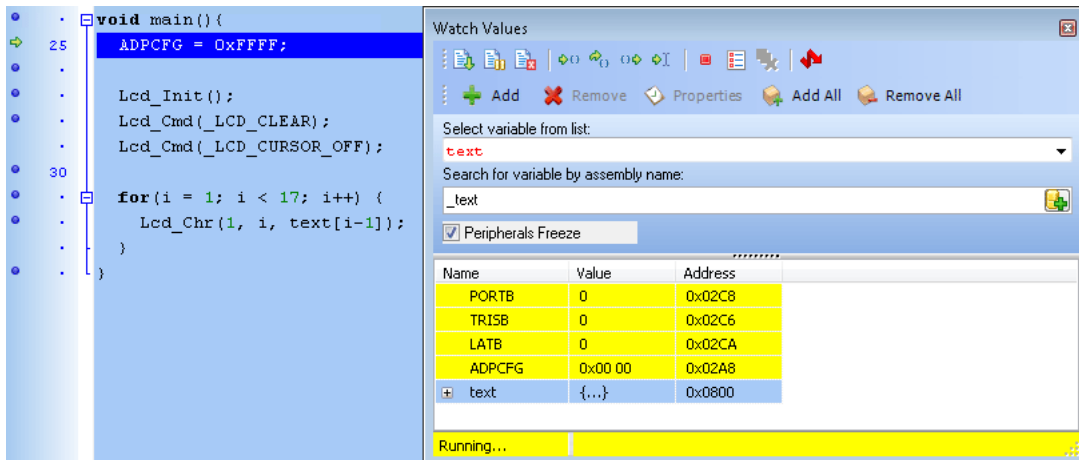





Run the mikroICD by selecting **Run > Start Debugger** from the drop-down menu or by clicking the Start Debugger Icon . Starting the Debugger makes more options available: Step Into, Step Over, Run to Cursor, etc. Line that is to be executed is color highlighted (blue by default). There is also notification about the program execution and it can be found in the Watch Window (yellow status bar). Note that some functions take more time to execute; execution is indicated with "Running..." message in the Watch Window Status Bar.



Related topics: mikroICD Debugger Example, mikroICD Debug Windows, mikroICD Debugger Options

mikroICD Debugger Options

Debugger Options

Name	Description	Function Key	Toolbar Icon
Start Debugger	Starts Debugger.	F9	
Stop Debugger	Stop Debugger.	Ctrl + F2	
Run/Pause Debugger	Run/Pause Debugger.	F6	
Step Into	Executes the current program line, then halts. If the executed program line calls another routine, the debugger steps into the routine and halts after executing the first instruction within it.	F7	
Step Over	Executes the current program line, then halts. If the executed program line calls another routine, the debugger will not step into it. The whole routine will be executed and the debugger halts at the first instruction following the call.	F8	
Step Out	Executes all remaining program lines within the subroutine. The debugger halts immediately upon exiting the subroutine.	Ctrl + F8	
Run To Cursor	Executes the program until reaching the cursor position.	F4	
Toggle Breakpoint	Toggle breakpoints option sets new breakpoints or removes those already set at the current cursor position.	F5	

Related topics: Run Menu, Debug Toolbar

mikroICD Debugger Example

Here is a step-by-step mikroICD Debugger Example.

Step No. 1

First you have to write a program. We will show how the mikroICD works using this example :

```
// Lcd module connections
sbit LCD_RS at LATD0_bit;
sbit LCD_EN at LATD1_bit;
sbit LCD_D4 at LATB0_bit;
sbit LCD_D5 at LATB1_bit;
sbit LCD_D6 at LATB2_bit;
sbit LCD_D7 at LATB3_bit;

sbit LCD_RS_Direction at TRISD0_bit;
sbit LCD_EN_Direction at TRISD1_bit;
sbit LCD_D4_Direction at TRISB0_bit;
sbit LCD_D5_Direction at TRISB1_bit;
sbit LCD_D6_Direction at TRISB2_bit;
sbit LCD_D7_Direction at TRISB3_bit;
// End Lcd module connections

char text[] = "mikroElektronika";
char i;

void Move_Delay() {
    Delay_ms(500);
}

void main() {
    ADPCFG = 0xFFFF;

    Lcd_Init();
    Lcd_Cmd(_LCD_CLEAR);
    Lcd_Cmd(_LCD_CURSOR_OFF);

    for(i = 1; i < 17; i++) {
        Lcd_Chr(1, i, text[i-1]);
    }
}
```

Step No. 2

After successful compilation and MCU programming press **F9** to start the mikroLCD. After the mikroLCD initialization a blue active line should appear.

The screenshot shows the mikroC IDE with the following code in the main() function:

```

void main() {
    ADPCFG = 0xFFFF;
    .
    .
    Lcd_Init();
    Lcd_Cmd(_LCD_CLEAR);
    Lcd_Cmd(_LCD_CURSOR_OFF);
    .
    .
    30
    for (i = 1; i < 17; i++) {
        Lcd_Ch(1, i, text[i-1]);
    }
    .
    .
}

```

The Watch Values window is open, showing the following table:

Name	Value	Address
PORTB	0	0x02C8
TRISB	0	0x02C6
LATB	0	0x02CA
ADPCFG	0x00 00	0x02A8
text	{...}	0x0800

PC= 0x0002B0 0.00 us

Step No. 3

We will debug the program line by line. To execute code line by line press [F8]. However, it is not recommended to use Step Over [F8] over Delay routines and routines containing delays. In this case use Run to cursor [F4] function or Run [F6] function combined with Breakpoints.

The screenshot shows the mikroC IDE with the following code in the main() function:

```

void main() {
    .
    .
    ADPCFG = 0xFFFF;
    .
    .
    27
    Lcd_Init();
    Lcd_Cmd(_LCD_CLEAR);
    Lcd_Cmd(_LCD_CURSOR_OFF);
    .
    .
    30
    for (i = 1; i < 17; i++) {
        Lcd_Ch(1, i, text[i-1]);
    }
    .
    .
}

```

The Watch Values window is open, showing the following table:

Name	Value	Address
PORTB	0	0x02C8
TRISB	0	0x02C6
LATB	0	0x02CA
ADPCFG	0xFF FF	0x02A8
text	{...}	0x0800

PC= 0x0002B4 0.00 us

Step No. 4

Step Into [F7], Step Over [F8] and Step Out [Ctrl+F8] are mikroCD debugger functions that are used in stepping mode. There is also a Real-Time mode supported by the mikroCD. Functions that are used in the Real-Time mode are Run/Pause Debugger [F6] and Run to cursor [F4]. Pressing F4 executes the code until the program reaches the cursor position line.

The screenshot shows the mikroC PRO for dsPIC IDE in Step Into (F7) mode. The code editor displays the following code:

```

void main() {
    ADPCFG = 0xFFFF;

    Lcd_Init();
    Lcd_Cmd(_LCD_CLEAR);
    Lcd_Cmd(_LCD_CURSOR_OFF);
    for(i = 1; i < 17; i++) {
        Lcd_Chr(1, i, text[i-1]);
    }
}
    
```

The Watch Values window is open, showing the following table:

Name	Value	Address
PORTB	0	0x02C8
TRISB	0	0x02C6
LATB	1	0x02CA
ADPCFG	0xFF FF	0x02A8
text	{...}	0x0800

The PC register is shown as 0x0002C2 and the time is 0.00 us.

Step No. 5

Run(Pause) Debugger [F6] and Toggle Breakpoints [F5] are mikroCD debugger functions that are used in the Real-Time mode. Pressing F5 marks the line selected by the user for breakpoint. F6 executes code until the breakpoint is reached. After reaching that breakpoint Debugger halts. Here in our example we will use breakpoints for writing a word "mikroElektronika" on LCD char by char. Breakpoint is set on LCD_Chr and the program will stop every time this function is reached. After reaching breakpoint we must press F6 again to continue the program execution.

The screenshot shows the mikroC PRO for dsPIC IDE in Run(Pause) Debugger (F6) mode. The code editor displays the same code as in Step No. 4, but with a breakpoint set on the Lcd_Chr function call (line 32). The Watch Values window is open, showing the same table of variables as in Step No. 4.

Name	Value	Address
PORTB	0	0x02C8
TRISB	0	0x02C6
LATB	1	0x02CA
ADPCFG	0xFF FF	0x02A8
text	{...}	0x0800

The PC register is shown as 0x0002CA and the time is 0.00 us.

Breakpoints are divided into two groups: hardware and software breakpoints. The hardware breakpoints are placed in the MCU and provide fastest debugging. Number of hardware breakpoints is limited (4 for PIC24 and dsPIC33 family, for dsPIC30 family this number depends on the MCU used). If all hardware breakpoints are used, then the next breakpoint will be software breakpoint. These breakpoints are placed inside the mikroICD and simulate hardware breakpoints. Software breakpoints are much slower than hardware breakpoints. These differences between hardware and software breakpoints are not visible in the mikroICD software but their different timings are quite notable. That's why it is important to know that there are two types of breakpoints.

The picture below demonstrates step-by-step execution of the code used in above mentioned examples.

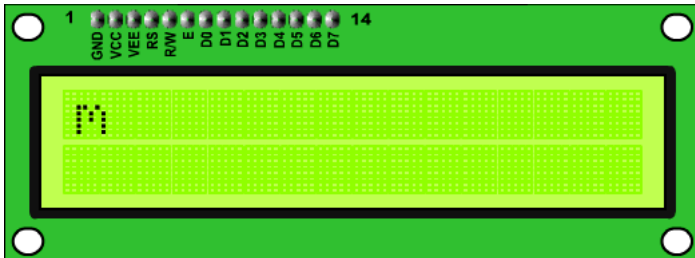

Common Errors :

- Trying to program the MCU while the mikroICD is active.
- Trying to debug **Release** build version of the program with the mikroICD debugger.
- Trying to debug program code which has been changed, but has not been compiled and programmed into the MCU.
- Trying to select line that is empty for Run to cursor [**F4**] and Toggle Breakpoints [**F5**] functions.
- Trying to debug MCU with mikroICD while Watch Dog Timer is enabled.
- Trying to debug MCU with mikroICD while Power Up Timer is enabled.
- Trying to **Step Into** [**F7**] the mikroC PRO for dsPIC30/33 and PIC24 Library routines. Use **Step Over** [**F8**] command for these routines.
- It is not possible to force Code Protect while trying to debug MCU with mikroICD.
- Trying to debug MCU with mikroICD with pull-up resistors set to ON on RB6 and RB7.

Related topics: mikroICD Debugger, mikroICD Debug Windows, mikroICD Debugger Options

mikroCD Debugger Windows

Debug Windows

This section provides an overview of available Debug Windows in mikroC PRO for dsPIC30/33 and PIC24 :

- Breakpoints Window
- Watch Values Window
- RAM Window
- Stopwatch Window
- EEPROM Watch Window
- Code Watch Window

Breakpoints Window

The Breakpoints window manages the list of currently set breakpoints in the project. Doubleclicking the desired breakpoint will cause cursor to navigate to the corresponding location in source code.

In situations when multiple breakpoints are used within the code, it is sometimes handy to enable/disable certain breakpoints. To do this, just check/uncheck the desired breakpoint using the checkbox in front of the breakpoint's name.

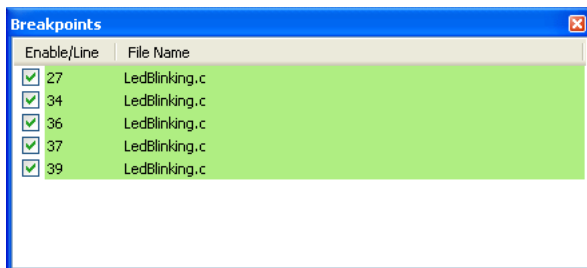

Watch Values Window

Watch Values Window is the main Debugger window which allows you to monitor program execution. To show the Watch Values Window, select **Debug Windows** > **Watch** from the **View** drop-down menu.

The Watch Values Window displays variables and registers of the MCU, with their addresses and values. Values are updated along with the code execution. Recently changed items are coloured red.

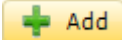
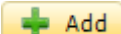

There are two ways to add variable/register into the watch list :

- by its real name (variable's name in program code). Just select wanted variable/register from **Select variable from list** drop-down menu and click the  button.
- by its name ID (assembly variable name). Simply type name ID of the variable/register you want to display into **Search for variable by assembly name** box and click the  button.

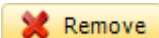
Also, it is possible to add all variables in the Watch Values Window by clicking  button.

To remove a variable from the Watch Values Window, just select the variable that you want to remove and then click the  button, or press the Delete key.

It is possible to remove all variables from the Watch Values Window by clicking  button.

You can also expand/collapse complex variables i.e. struct type variables, strings, etc. by clicking the appropriate button ( or ) beside variable name.

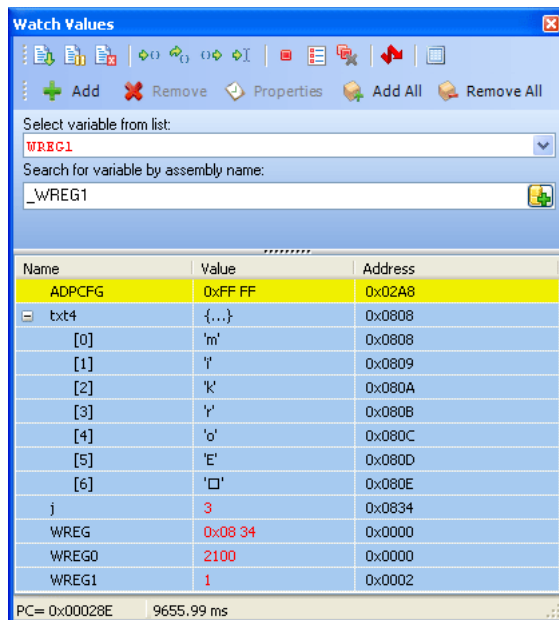

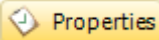
Double clicking a variable or clicking the  button opens the Edit Value window in which you can assign a new value to the selected variable/register. Also, you can choose the format of variable/register representation between decimal, hexadecimal, binary, float or character. All representations except float are unsigned by default. For signed representation click the check box next to the **Signed** label.

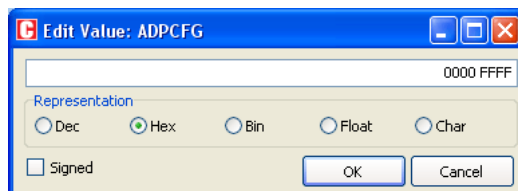

An item's value can also be changed by double clicking item's value field and typing the new value directly.

RAM Window

The RAM Window is available from the drop-down menu, **View > Debug Windows > RAM**.

The RAM Window displays the map of MCU's RAM, with recently changed items colored red. The user can edit and change the values in the RAM window.

mikroICD Specific : RAM window content will be written to the MCU before the next instruction execution.

	00	01	02	03	04	05	06	07	08	09	0A	0B	0C	0D	0E	0F	ASCII
0780	00	00	00	00	00	00	00	00	00	00	00	00	00	00	00	00
0790	00	00	00	00	00	00	00	00	00	00	00	00	00	00	00	00
07A0	00	00	00	00	00	00	00	00	00	00	00	00	00	00	00	00
07B0	00	00	00	00	00	00	00	00	00	00	00	00	00	00	00	00
07C0	00	00	00	00	00	00	00	00	00	00	00	00	00	00	00	00
07D0	00	00	00	00	00	00	00	00	00	00	00	00	00	00	00	00
07E0	00	00	00	00	00	00	00	00	00	00	00	00	00	00	00	00
07F0	00	00	00	00	00	00	00	00	00	00	00	00	00	00	00	00
0800	4C	63	64	34	62	69	74	00	6D	69	6B	72	6F	45	00	6D	Lcd4bit.mikroE
0810	69	68	72	6F	45	6C	65	6B	74	72	6F	6E	69	68	61	00	ikroElektronika
0820	45	61	73	79	64	73	50	49	43	34	00	00	01	00	0C	03	EasydsPIC4.. <
0830	00	00	00	00	08	02	A6	02	00	00	18	02	00	00	36	01	...
0840	00	00	00	00	00	00	00	00	00	00	00	00	00	00	00	00
0850	00	00	00	00	00	00	00	00	00	00	00	00	00	00	00	00
0860	00	00	00	00	00	00	00	00	00	00	00	00	00	00	00	00

Stopwatch Window

The Software Simulator Stopwatch Window is available from the drop-down menu, **View > Debug Windows > Stopwatch**.

The Stopwatch Window displays a **Current Count** of cycles/time since the last Software Simulator action. **Stopwatch** measures the execution time (number of cycles) from the moment Software Simulator has started and can be reset at any time. **Delta** represents the number of cycles between the lines where Software Simulator action has started and ended.

Watch Clock	
Cycles:	Time:
Current Count: 2,103,943,273	105.20 s
Delta: 80,881,413	4044.07 ms
Stopwatch: 2,103,943,273	105197.16 ms
<input type="button" value="Reset To Zero"/>	
Clock: 80	MHz

Notes :

- The user can change the clock in the Stopwatch Window, which will recalculate values for the latest specified frequency.
- Changing the clock in the Stopwatch Window does not affect actual project settings – it only provides a simulation.
- Stopwatch is available only when Software Simulator is selected as a debugger.

EEPROM Watch Window

Note : EEPROM Watch Window is available only when mikroICD is selected as a debugger.

To show the EEPROM Watch Window, select **Debug Windows > EEPROM** from the **View** drop-down menu. The EEPROM Watch Window shows current content of the MCU's internal EEPROM memory.

There are two action buttons concerning the EEPROM Watch Window :

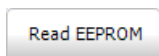

- Reads data from MCU's internal EEPROM memory and loads it up into the EEPROM window.

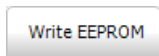

- Writes data from the EEPROM window into MCU's internal EEPROM memory.

The screenshot shows the EEPROM Watch window with two buttons at the top: "Read EEPROM" and "Write EEPROM". Below the buttons is a table representing the EEPROM memory dump. The table has columns for addresses (00-0F) and an ASCII column. The data shows that addresses 0320-03F0 contain the value 0xFF, while addresses 0400-04FF contain the value 0x00.

	00	01	02	03	04	05	06	07	08	09	0A	0B	0C	0D	0E	0F	ASCII
0320	FF	FF	FF	FF	FF	FF	FF	FF	FF	FF	FF	FF	FF	FF	FF	FF	...
0330	FF	FF	FF	FF	FF	FF	FF	FF	FF	FF	FF	FF	FF	FF	FF	FF	...
0340	FF	FF	FF	FF	FF	FF	FF	FF	FF	FF	FF	FF	FF	FF	FF	FF	...
0350	FF	FF	FF	FF	FF	FF	FF	FF	FF	FF	FF	FF	FF	FF	FF	FF	...
0360	FF	FF	FF	FF	FF	FF	FF	FF	FF	FF	FF	FF	FF	FF	FF	FF	...
0370	FF	FF	FF	FF	FF	FF	FF	FF	FF	FF	FF	FF	FF	FF	FF	FF	...
0380	FF	FF	FF	FF	FF	FF	FF	FF	FF	FF	FF	FF	FF	FF	FF	FF	...
0390	FF	FF	FF	FF	FF	FF	FF	FF	FF	FF	FF	FF	FF	FF	FF	FF	...
03A0	FF	FF	FF	FF	FF	FF	FF	FF	FF	FF	FF	FF	FF	FF	FF	FF	...
03B0	FF	FF	FF	FF	FF	FF	FF	FF	FF	FF	FF	FF	FF	FF	FF	FF	...
03C0	FF	FF	FF	FF	FF	FF	FF	FF	FF	FF	FF	FF	FF	FF	FF	FF	...
03D0	FF	FF	FF	FF	FF	FF	FF	FF	FF	FF	FF	FF	FF	FF	FF	FF	...
03E0	FF	FF	FF	FF	FF	FF	FF	FF	FF	FF	FF	FF	FF	FF	FF	FF	...
03F0	FF	FF	FF	FF	FF	FF	FF	FF	FF	FF	FF	FF	FF	FF	FF	FF	...
0400	00	00	00	00	00	00	00	00	00	00	00	00	00	00	00	00
0410	00	00	00	00	00	00	00	00	00	00	00	00	00	00	00	00
0420	00	00	00	00	00	00	00	00	00	00	00	00	00	00	00	00
0430	00	00	00	00	00	00	00	00	00	00	00	00	00	00	00	00
0440	00	00	00	00	00	00	00	00	00	00	00	00	00	00	00	00
0450	00	00	00	00	00	00	00	00	00	00	00	00	00	00	00	00
0460	00	00	00	00	00	00	00	00	00	00	00	00	00	00	00	00
0470	00	00	00	00	00	00	00	00	00	00	00	00	00	00	00	00
0480	00	00	00	00	00	00	00	00	00	00	00	00	00	00	00	00
0490	00	00	00	00	00	00	00	00	00	00	00	00	00	00	00	00
04A0	00	00	00	00	00	00	00	00	00	00	00	00	00	00	00	00
04B0	00	00	00	00	00	00	00	00	00	00	00	00	00	00	00	00

STATUS: Idle

Code Watch Window

Note : Code Watch Window is available only when mikroCD is selected as a debugger.

To show the Code Watch Window, select **Debug Windows > Code** from the **View** drop-down menu.

The Code Watch Window shows code (hex format) written into the MCU.

There is one action button concerning the Code Watch Window :

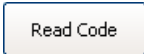

- Reads code from the MCU and loads it up into the Code Window. Code reading is resources consuming operation so the user should wait until the reading is over.

Also, you can set an address scope in which hex code will be read.

The screenshot shows the 'CODE Watch' window with a 'Read Code' button and an 'Address Scope' field. Below is a table of memory addresses and their corresponding hex and ASCII values.

	00	02	04	06	08	0A	0C	0E	ASCII
0200	A75010	A822CA	470060	A64010	A902CA	A74010	A802CA	2088C0	<DLE> p§ È "" ` .G <DLE
0210	A60010	A802D6	A70010	A902D6	07FF96	470060	A63010	A962CA	<DLE> .; Ò <STX>" <DL
0220	A73010	A862CA	470060	A62010	A942CA	A72010	A842CA	470060	<DLE> 0§ È b" ` .G <DU
0230	A61010	A922CA	A71010	A822CA	470060	A60010	A902CA	A70010	<DLE> <DLE> È " <DI
0240	A802CA	2088C0	A60010	A802D6	A70010	A902D6	07FF7C	2088C0	È <STX>" À ^ <SPC> <D
0250	A60010	370002	07FF64	370001	07FF86	FA8000	060000	FA0002	<DLE> .; Ò <STX> .7 d y <
0260	37000F	200800	9FBF40	370019	200C00	9FBF40	370016	200940	<SI> .7 . <BS> <SPC> €
0270	9FBF40	370013	200D40	9FBF40	370010	200800	9FBF40	37000D	@ ÿ <DC3> .7 @ <CR>
0280	97B84E	E10061	32FFEE	97B84E	E10062	32FFEE	97B84E	E10063	N _ - a .á ÿ2 N _ - b .á
0290	32FFEE	97B84E	E10064	32FFEE	37FFF0	97B83E	5000E1	570068	ï y2 N _ - d .á ÿ2 d ÿ7 >
02A0	408010	9FBF40	781F80	07FF9B	B1002F	2088C0	A10010	EF2000	<DLE> € @ @ ÿ È <US>
02B0	980700	97B8AE	470060	408010	E00410	32000C	97B8AE	470060	. <BELL>" @ _ - ` .G <L
02C0	408010	784010	FB8000	781F80	07FF32	B1002F	200011	470060	<DLE> € @ <DLE> @x . +
02D0	408810	37FFEF	2088C0	A00010	FA8000	060000	FA0002	EF2000	<DLE> ^ @ ÿ7 À ^ <SPC
02E0	984700	90400E	E10468	310009	2001C0	781F80	07FF78	B1002F	. G" <SO> @ ð h <EOT:
02F0	07FF31	B3C011	470060	40C810	37FFF4	FA8000	060000	FA0002	1 ÿ <BELL> <DC1> À? `
0300	EF2000	984700	90400E	E10468	310009	200180	781F80	07FF67	. <SPC> . l . G" <SO> @ C
0310	B1002F	07FF20	B3C011	470060	40C810	37FFF4	FA8000	060000	/ . ð <SPC> ÿ <BELL> <C
0320	2088EF	20FFF0	B7A020	200000	B7A034	200040	B72044	FA0000	ï ^ <SPC> ð ð <SPC> <SF
0330	0203D8	000000	2FFFF0	B7A2A8	07FF1D	2000C0	781F80	07FF4F	Ø <ETX> <STX> . . . ð y/
0340	B1002F	208610	781F80	200060	781F80	200010	781F80	07FF87	/ . ð <DLE> † <SPC> € <
0350	B1006F	208690	781F80	200060	781F80	200020	781F80	07FF7F	o . ð ð † <SPC> € <US>
0360	B1006F	200CC8	273987	ED200E	3AFFFE	ED2010	3AFFFC	200010	o . ð È <FF> <SPC> † 9'
0370	781F80	07FF35	B1002F	208700	781F80	200010	781F80	200010	€ <US> × 5 ÿ <BELL> / . ð
0380	781F80	07FF6D	B1006F	208810	781F80	200050	781F80	200020	€ <US> × m ÿ <BELL> o . :

STATUS: Idle

CHAPTER 5

Software Simulator Overview

Software Simulator

The Source-level Software Simulator is an integral component of the mikroC PRO for dsPIC30/33 and PIC24 environment. It is designed to simulate operations of the Microchip dsPIC30/33 and PIC24 MCUs and assist the users in debugging code written for these devices.

Upon completion of writing your program, choose **Release** build Type in the Project Settings window:

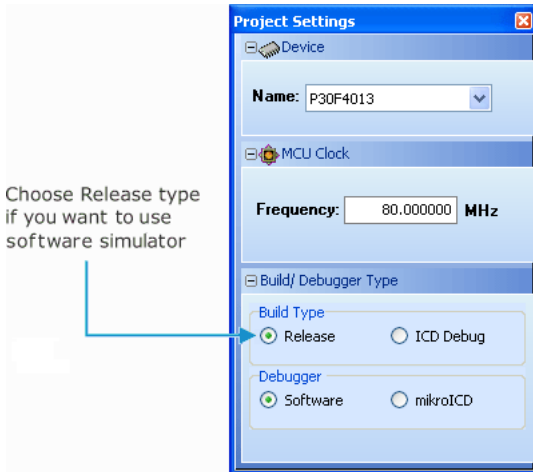

After you have successfully compiled your project, you can run the Software Simulator by selecting **Run > Start Debugger** from the drop-down menu, or by clicking the Start Debugger Icon  from the Debugger Toolbar.

Starting the Software Simulator makes more options available: Step Into, Step Over, Step Out, Run to Cursor, etc. Line that is to be executed is color highlighted (blue by default).

Note : The Software Simulator simulates the program flow and execution of instruction lines, but it cannot fully emulate dsPIC device behavior, i.e. it doesn't update timers, interrupt flags, etc.

Related topics: Software Simulator Debug Windows, Software Simulator Debugger Options

Software Simulator Debug Windows

Debug Windows

This section provides an overview of available Debug Windows in mikroC PRO for dsPIC30/33 and PIC24 :

- Breakpoints Window
- Watch Values Window
- RAM Window
- Stopwatch Window
- EEPROM Watch Window
- Code Watch Window

Breakpoints Window

The Breakpoints window manages the list of currently set breakpoints in the project. Doubleclicking the desired breakpoint will cause cursor to navigate to the corresponding location in source code.

In situations when multiple breakpoints are used within the code, it is sometimes handy to enable/disable certain breakpoints. To do this, just check/uncheck the desired breakpoint using the checkbox in front of the breakpoint's name.

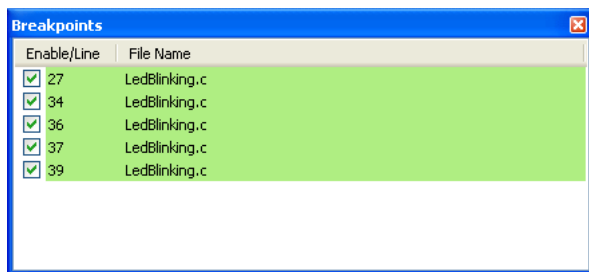

Watch Values Window

Watch Values Window is the main Debugger window which allows you to monitor program execution. To show the Watch Values Window, select **Debug Windows** › **Watch** from the **View** drop-down menu.

The Watch Values Window displays variables and registers of the MCU, with their addresses and values. Values are updated along with the code execution. Recently changed items are coloured red.

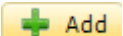

There are two ways to add variable/register into the watch list :

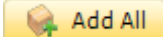
- by its real name (variable's name in program code). Just select wanted variable/register from **Select variable from list** drop-down menu and click the  button.
- by its name ID (assembly variable name). Simply type name ID of the variable/register you want to display into Search for variable by assembly name box and click the  button.

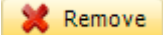
Also, it is possible to add all variables in the Watch Values Window by clicking  button.

To remove a variable from the Watch Values Window, just select the variable that you want to remove and then click the  button, or press the Delete key.

It is possible to remove all variables from the Watch Values Window by clicking  button.

You can also expand/collapse complex variables i.e. struct type variables, strings, etc, by clicking the appropriate button ( or ) beside variable name.

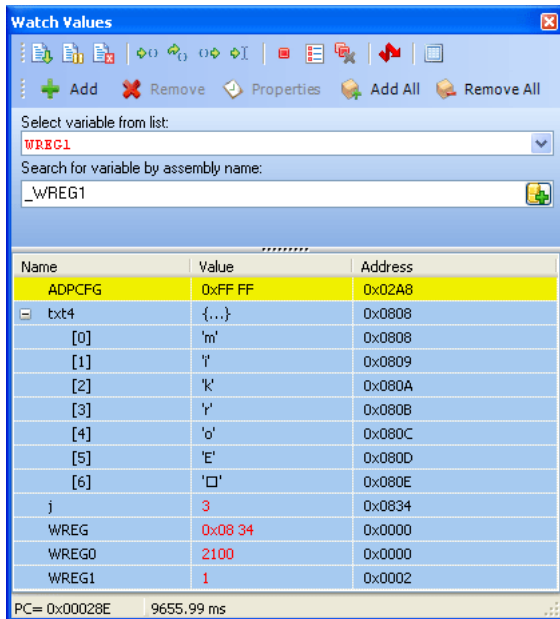

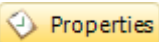
Double clicking a variable or clicking the  button opens the Edit Value window in which you can assign a new value to the selected variable/register. Also, you can choose the format of variable/register representation between decimal, hexadecimal, binary, float or character. All representations except float are unsigned by default. For signed representation click the check box next to the **Signed** label.

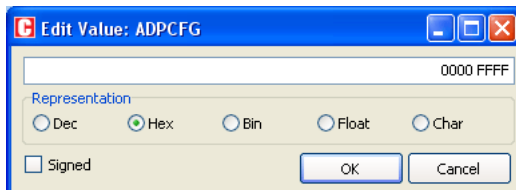

An item's value can also be changed by double clicking item's value field and typing the new value directly.

RAM Window

The RAM Window is available from the drop-down menu, **View > Debug Windows > RAM**.

The RAM Window displays the map of MCU's RAM, with recently changed items colored red. The user can edit and change the values in the RAM window.

mikroICD Specific : RAM window content will be written to the MCU before the next instruction execution.

	00	01	02	03	04	05	06	07	08	09	0A	0B	0C	0D	0E	0F	ASCII
0780	00	00	00	00	00	00	00	00	00	00	00	00	00	00	00	00
0790	00	00	00	00	00	00	00	00	00	00	00	00	00	00	00	00
07A0	00	00	00	00	00	00	00	00	00	00	00	00	00	00	00	00
07B0	00	00	00	00	00	00	00	00	00	00	00	00	00	00	00	00
07C0	00	00	00	00	00	00	00	00	00	00	00	00	00	00	00	00
07D0	00	00	00	00	00	00	00	00	00	00	00	00	00	00	00	00
07E0	00	00	00	00	00	00	00	00	00	00	00	00	00	00	00	00
07F0	00	00	00	00	00	00	00	00	00	00	00	00	00	00	00	00
0800	4C	63	64	34	62	69	74	00	6D	69	68	72	6F	45	00	6D	Lcd4bit.mikroE
0810	69	6B	72	6F	45	6C	65	6B	74	72	6F	6E	69	68	61	00	ikroElektronika
0820	45	61	73	79	64	73	50	49	43	34	00	00	01	00	0C	03	EasydsPIC4..<
0830	00	00	00	00	08	02	A6	02	00	00	18	02	00	00	36	01	...
0840	00	00	00	00	00	00	00	00	00	00	00	00	00	00	00	00
0850	00	00	00	00	00	00	00	00	00	00	00	00	00	00	00	00
0860	00	00	00	00	00	00	00	00	00	00	00	00	00	00	00	00
0870	00	00	00	00	00	00	00	00	00	00	00	00	00	00	00	00

Stopwatch Window

The Software Simulator Stopwatch Window is available from the drop-down menu, **View > Debug Windows > Stopwatch**.

The Stopwatch Window displays a **Current Count** of cycles/time since the last Software Simulator action. **Stopwatch** measures the execution time (number of cycles) from the moment Software Simulator has started and can be reset at any time.

Delta represents the number of cycles between the lines where Software Simulator action has started and ended.

	Cycles:	Time:
Current Count:	2,103,943,273	105.20 s
Delta:	80,881,413	4044.07 ms
Stopwatch:	2,103,943,273	105197.16 ms
	Reset To Zero	
Clock:	80	MHz

Notes :

The user can change the clock in the Stopwatch Window, which will recalculate values for the latest specified frequency.

Changing the clock in the Stopwatch Window does not affect actual project settings – it only provides a simulation. Stopwatch is available only when Software Simulator is selected as a debugger.

EEPROM Watch Window

Note : EEPROM Watch Window is available only when mikroCD is selected as a debugger.

To show the EEPROM Watch Window, select **Debug Windows > EEPROM** from the **View** drop-down menu. The EEPROM Watch Window shows current content of the MCU's internal EEPROM memory.

There are two action buttons concerning the EEPROM Watch Window :

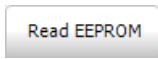
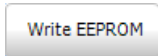
-  - Reads data from MCU's internal EEPROM memory and loads it up into the EEPROM window.
-  - Writes data from the EEPROM window into MCU's internal EEPROM memory.

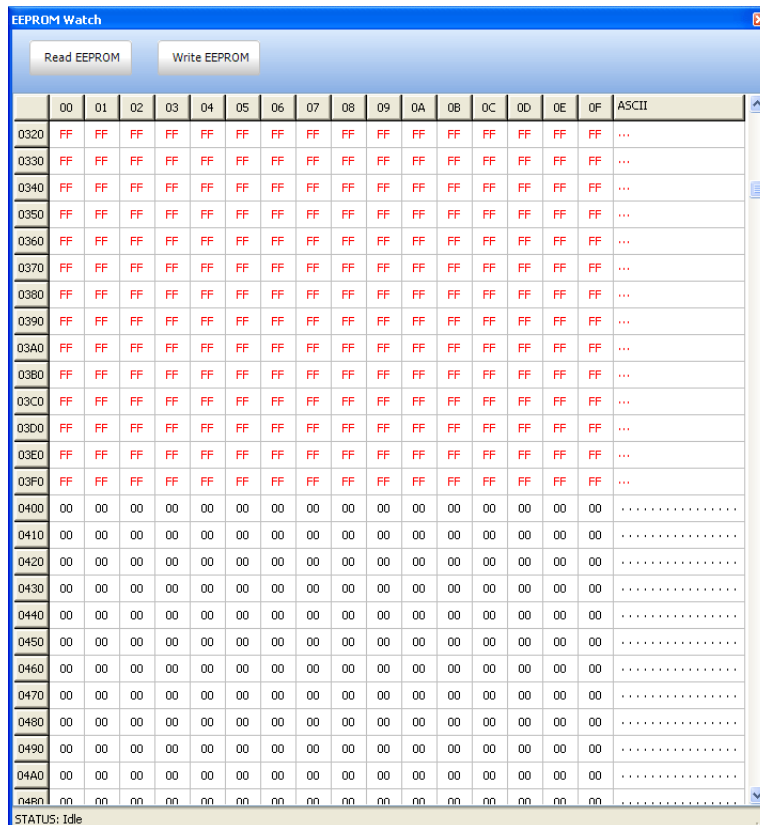

Code Watch Window

Note : Code Watch Window is available only when mikroICD is selected as a debugger.

To show the Code Watch Window, select **Debug Windows > Code** from the **View** drop-down menu.

The Code Watch Window shows code (hex format) written into the MCU.

There is one action button concerning the Code Watch Window :

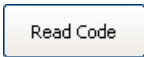

- Reads code from the MCU and loads it up into the Code Window. Code reading is resources consuming operation so the user should wait until the reading is over.

Also, you can set an address scope in which hex code will be read.









The screenshot shows the 'CODE Watch' window with an 'Address Scope' field set from 000000 to 008000. Below the field is a table with columns for memory addresses (00, 02, 04, 06, 08, 0A, 0C, 0E) and ASCII. The table contains 16 rows of data, each representing a memory location and its contents in both hex and ASCII formats.

	00	02	04	06	08	0A	0C	0E	ASCII
0200	A75010	A822CA	470060	A64010	A902CA	A74010	A802CA	2088C0	<DLE> PŠ Ě " " ` .G <DLE>
0210	A60010	A802D6	A70010	A902D6	07FF96	470060	A63010	A962CA	<DLE> . Ő <STX> " <DLE>
0220	A73010	A862CA	470060	A62010	A942CA	A72010	A842CA	470060	<DLE> 0š Ě b " ` .G <DLE>
0230	A61010	A922CA	A71010	A822CA	470060	A60010	A902CA	A70010	<DLE> <DLE> Ě " <DLE>
0240	A802CA	2088C0	A60010	A802D6	A70010	A902D6	07FF7C	2088C0	Ě <STX> " Ā ^ <SPC> <DLE>
0250	A60010	370002	07FF64	370001	07FF86	FA8000	060000	FA0002	<DLE> . <STX> .7 d ý <DLE>
0260	37000F	200800	9FBF40	370019	200C00	9FBF40	370016	200940	<SI> .7 . <B5> <SPC> @ <DLE>
0270	9FBF40	370013	200D40	9FBF40	370010	200800	9FBF40	37000D	@ ý <DC3> .7 @ <CR> <DLE>
0280	97B84E	E10061	32FFEE	97B84E	E10062	32FFEE	97B84E	E10063	N _- a .á í ý2 N _- b .á <DLE>
0290	32FFEE	97B84E	E10064	32FFEE	37FFF0	97B83E	5000E1	570068	í ý2 N _- d .á í ý2 á ý7 > <DLE>
02A0	408010	9FBF40	781F80	07FF9B	B1002F	2088C0	A10010	EF2000	<DLE> €@ @ ý ě <US> <DLE>
02B0	980700	97B8AE	470060	408010	E00410	32000C	97B8AE	470060	. <BELL> " @ _- ` .G <DLE>
02C0	408010	784010	FB8000	781F80	07FF32	B1002F	200011	470060	<DLE> €@ <DLE> @x . <DLE>
02D0	408810	37FFEF	2088C0	A00010	FA8000	060000	FA0002	EF2000	<DLE> ^@ í ý7 Ā ^ <SPC> <DLE>
02E0	984700	90400E	E10468	310009	2001C0	781F80	07FF78	B1002F	. G " <SO> @□ h <EOT> <DLE>
02F0	07FF31	B3C011	470060	40C810	37FFF4	FA8000	060000	FA0002	1 ý <BELL> <DC1> Ā ? ` <DLE>
0300	EF2000	984700	90400E	E10468	310009	200180	781F80	07FF67	. <SPC> Ā . G " <SO> @□ <DLE>
0310	B1002F	07FF20	B3C011	470060	40C810	37FFF4	FA8000	060000	/ .± <SPC> ý <BELL> <DLE>
0320	2088EF	20FFF0	B7A020	200000	B7A034	200040	B72044	FA0000	í ^ <SPC> á ý <SPC> <SF> <DLE>
0330	0203D8	000000	2FFFF0	B7A2A8	07FF1D	2000C0	781F80	07FF4F	∅ <ETX> <STX> ... á ý / <DLE>
0340	B1002F	208610	781F80	200060	781F80	200010	781F80	07FF87	/ .± <DLE> † <SPC> € <DLE>
0350	B1006F	208690	781F80	200060	781F80	200020	781F80	07FF7F	o .± □ † <SPC> € <US> <DLE>
0360	B1006F	200CC8	273987	ED200E	3AFFFE	ED2010	3AFFFC	200010	o .± Ě <FF> <SPC> † 9' <DLE>
0370	781F80	07FF35	B1002F	208700	781F80	200010	781F80	200010	€ <US> × 5 ý <BELL> / .± <DLE>
0380	781F80	07FF6D	B1006F	208810	781F80	200050	781F80	200020	€ <US> × m ý <BELL> o .: <DLE>

STATUS: Idle

Software Simulator Debugger Options

Debugger Options

Name	Description	Function Key	Toolbar Icon
Start Debugger	Starts Debugger.	F9	
Stop Debugger	Stop Debugger.	Ctrl + F2	
Run/Pause Debugger	Run/Pause Debugger.	F6	
Step Into	Executes the current program line, then halts. If the executed program line calls another routine, the debugger steps into the routine and halts after executing the first instruction within it.	F7	
Step Over	Executes the current program line, then halts. If the executed program line calls another routine, the debugger will not step into it. The whole routine will be executed and the debugger halts at the first instruction following the call.	F8	
Step Out	Executes all remaining program lines within the subroutine. The debugger halts immediately upon exiting the subroutine.	Ctrl + F8	
Run To Cursor	Executes the program until reaching the cursor position.	F4	
Toggle Breakpoint	Toggle breakpoints option sets new breakpoints or removes those already set at the current cursor position.	F5	

Related topics: Run Menu, Debug Toolbar

CHAPTER 6

mikroC PRO for dsPIC30/33 and PIC24 Specifics

The following topics cover the specifics of mikroC PRO for dsPIC30/33 and PIC24 compiler:

- ANSI Standard Issues
- Predefined Globals and Constants
- Accessing Individual Bits
- Interrupts
- Linker Directives
- Built-in Routines
- Code Optimization

GOTO Table

If a certain routine is allocated on the address higher than 64kB and can not be accessed directly, a GOTO table is created just after the Interrupt Vector Table to enable this routine call.

GOTO table comprises of addresses of those routines that are allocated on the addresses higher than 64kB.

So, whenever a call is made to a routine which is not directly accessible, it jumps to an assigned GOTO table block which contains address of a desired routine. From there, a GOTO call is generated to that address, and the routine is executed.

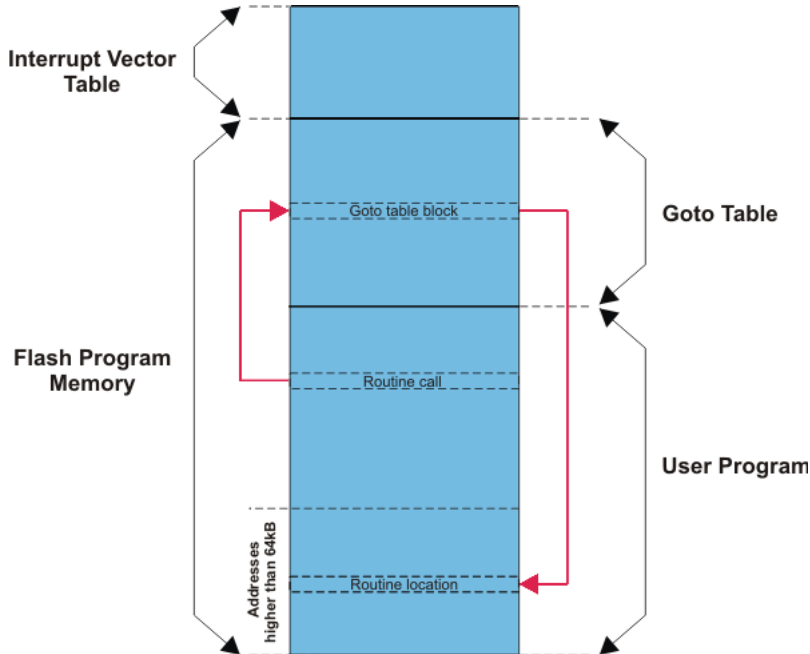

ANSI Standard Issues

Divergence from the ANSI C Standard

The mikroC PRO for dsPIC30/33 and PIC24 diverges from the ANSI C standard in a few areas. Some of these modifications are improvements intended to facilitate dsPIC programming, while others are the result of dsPIC30/33 and PIC24 hardware limitations.

- Case Sensitivity. Check identifiers
- The mikroC PRO for dsPIC30/33 and PIC24 treats identifiers declared with the `const` qualifier as “true constants” (C++ style). This allows using const objects in places where ANSI C expects a constant expression. If aiming at portability, use the traditional preprocessor defined constants. See Type Qualifiers and Constants.
- The mikroC PRO for dsPIC30/33 and PIC24 allows C++ style single–line comments using two adjacent slashes (`//`). The comment can start at any position and extends until the next new line. See Comments.
- A number of standard C libraries (`ctype`, `math`, `stdlib`, `string`) have been implemented; check the individual functions for divergence.
- The mikroC PRO for dsPIC30/33 and PIC24 does not provide automatic initialization for objects. Uninitialized globals and objects with static duration will take random values from memory.
- Anonymous unions and structures are now supported.

C Language Extensions

mikroC PRO for dsPIC30/33 and PIC24 has additional set of keywords that do not belong to the ANSI standard C language keywords:

- `code`
- `data`
- `rx`
- `sfr`
- `xdata`
- `ydata`
- `dma`
- `near`
- `far`
- `at`
- `sbit`
- `bit`
- `iv`

Implementation-defined Behavior

Certain sections of the ANSI standard have implementation-defined behavior. This means that the exact behavior of some C code can vary from compiler to compiler. This Help contains the sections describing how the mikroC PRO for dsPIC30/33 and PIC24 compiler behaves in such situations.

The most notable specifics include:

- Storage Classes
- Bit Fields

Related topics: Keywords, dsPIC30/33 and PIC24 Specifics

Predefined Globals and Constants

To facilitate dsPIC30/33 and PIC24 programming, the mikroC PRO for dsPIC30/33 and PIC24 implements a number of predefined globals and constants.

All dsPIC30/33 and PIC24 **SFR registers** are implicitly declared as global variables of volatile unsigned int. These identifiers have an external linkage, and are visible in the entire project. When creating a project, the mikroC PRO for dsPIC30/33 and PIC24 will include an appropriate (*.c) file from defs folder, containing declarations of available **SFR registers** and constants (such as PORTB, ADPCFG, etc). All identifiers are in upper case, identical to nomenclature in the Microchip datasheets. All dsPIC30/33 and PIC24 **SFR registers** are also available as structures with bitfields named identically to the Microchip datasheets in order to facilitate bit access e.g

```
TRISBbits.TRISB3 = 1.
```

For a complete set of predefined globals and constants, look for “Defs” in the mikroC PRO for dsPIC30/33 and PIC24 installation folder, or probe the Code Assistant for specific letters (Ctrl+Space in the Code Editor).

Predefined project level defines

mikroC PRO for dsPIC30/33 and PIC24 provides several predefined project level defines that you can use in your project :

- First one is equal to the name of selected device for the project i.e. if P30f4013 is selected device, then P30f4013 token will be defined as 1, so it can be used for conditional compilation :

```
#ifdef P30F4013
...
#endif
```

- The second one is value of frequency (in kHz) for which the project is built :

```
#ifdef __FOSC__ == 80000
...
#endif
```

- Third one is for identifying mikroC PRO for dsPIC30/33 and PIC24 compiler :

```
#ifdef __MIKROC_PRO_FOR_DSPIC__
...
#endif
```

- Fourth one is for identifying the build version. For instance, if a desired build version is 142, user should put this in his code :

```
#if __MIKROC_PRO_FOR_DSPIC_BUILD__ == 142
...
#endif
```

Related topics: Project Level Defines

Accessing Individual Bits

The mikroC PRO for dsPIC30/33 and PIC24 allows you to access individual bits of 16-bit variables. It also supports sbit and bit data types.

Lets use the Zero bit as an example. This bit is defined in the definition file of the particular MCU as :

```
const register unsigned short int Z = 1;
sbit Z_bit at SR.B1;
```

To access this bit in your code by its name, you can write something like this:

```
// Clear Zero bit
SR.Z = 0;
```

In this way, if Zero bit changes its position in the register, you are sure that the appropriate bit will be affected. But, if Zero bit is not located in the designated register, you may get errors.

Another way of accessing bits is by using the direct member selector (.) with a variable, followed by one of identifiers B0, B1, ... , B15, or F0, F1, ... F15, with F15 being the most significant bit, to access the desired bit :

```
// predefined globals as bit designators
// Clear Zero bit
SR.B1 = 0;

// Set Zero bit
SR.F1 = 1;
```

In this way, if the target bit changes its position in the register, you cannot be sure that you are invoking the appropriate bit.

This kind of selective access is an intrinsic feature of mikroC PRO for dsPIC30/33 and PIC24 and can be used anywhere in the code. Identifiers B0–B15 are not case sensitive and have a specific namespace.

You may override them with your own members B0–B15 within any given structure.

When using literal constants as bit designators instead of predefined ones, make sure not to exceed the appropriate type size.

Also, you can access the desired bit by using its alias name, in this case `Z_bit` :

```
// Set Zero Bit
C_bit = 1;
```

In this way, if the Zero bit changes its register or position in the register, you are sure that the appropriate bit will be affected.

For backward compatibility, you can access bits in this way also :

```
// Clear TRISB3
TRISBbits.TRISB3 = 0;
```

Note : If aiming at portability, avoid this style of accessing individual bits, use the bit fields instead.

See Predefined Globals and Constants for more information on register/bit names.

sbit type

The mikroC PRO for dsPIC30/33 and PIC24 compiler has sbit data type which provides access to registers, SFRs, variables, etc.

You can declare a `sbit` variable in a unit in such way that it points to a specific bit in SFR register:

```
extern sfr sbit ABit; // ABit is precisely defined in some external file, for example in
the main program unit
```

In the main program you have to specify to which register this sbit points to, for example:

```
sbit ABit at PORTB.B0; // this is where ABit is fully defined
...
void main() {
...
}
```

In this way the variable `ABit` will actually point to `PORTB.0`. Please note that we used the keyword `sfr` for declaration of `ABit`, because we are pointing it to `PORTB` which is defined as a `sfr` variable.

Note : Declaring a `sbit` variable is not possible via `F0`, `F1`, ... `F15` identifiers.

In case we want to declare a bit over a variable which is not defined as `sfr`, then the keyword `sfr` is not necessary, for example:

```
extern sbit AnotherBit; // AnotherBit is precisely defined in some external file, for
example in the main program unit
```

```
char MyVar;
sbit AnotherBit at MyVar.B0; // this is where AnotherBit is fully defined
...
void main() {
...
}
```

at keyword

You can use the keyword "at" to make an alias to a variable, for example, you can write a library without using register names, and later in the main program to define those registers, for example :

```
extern char PORTAlias; // here in the library we can use its symbolic name

char PORTAlias at PORTB; // this is where PORTAlias is fully defined
...
void main() {
...
}
```

Note : Bear in mind that when using at operator in your code over a variable defined through a extern modifier, appropriate memory specifier must be appended also.

bit type

The mikroC PRO for dsPIC30/33 and PIC24 compiler provides a `bit` data type that may be used for variable declarations. It can not be used for argument lists, and function-return values.

```
bit bf; // bit variable
```

There are no pointers to bit variables:

```
bit *ptr; // invalid
```

An array of type bit is not valid:

```
bit arr[5]; // invalid
```

Note :

- Bit variables can not be initialized.
- Bit variables can not be members of structures and unions.
- Bit variables do not have addresses, therefore unary operator `&` (address of) is not applicable to these variables.

Related topics: Bit fields, Predefined globals and constants, Extern modifier

Interrupts

The dsPIC30/33 and PIC24 interrupt controller module reduces numerous peripheral interrupt request signals to a single interrupt request signal to the dsPIC30/33 and PIC24 CPU and has the following features:

- Up to 8 processor exceptions and software traps
- 7 user-selectable priority levels
- Interrupt Vector Table (IVT) with up to 62 vectors (dsPIC30) or up to 118 vectors (dsPIC33 and PIC24)
- A unique vector for each interrupt or exception source
- Fixed priority within a specified user priority level
- Alternate Interrupt Vector Table (AIVT) for debug support

ISRs are organized in IVT. ISR is defined as a standard function but with the `iv` directive afterwards which connects the function with specific interrupt vector. For example `iv IVT_ADDR_T1INTERRUPT` is IVT address of Timer1 interrupt source of the dsPIC 30F3014 MCU. For more information on IVT refer to the dsPIC30/33 and PIC24 Family Reference Manual.

Function Calls from Interrupt

Calling functions from within the interrupt routine is possible. The compiler takes care about the registers being used, both in "interrupt" and in "main" thread, and performs "smart" context-switching between two of them, saving only the registers that have been used in both threads. It is not recommended to use a function call from interrupt. In case of doing that take care of stack depth.

Disable Context Saving

Use the `#pragma disablecontexsaving` to instruct the compiler not to automatically perform context-switching. This means that no register will be saved/restored by the compiler on entrance/exit from interrupt service routine, except STATUS, WREG and BSR registers in high priority interrupt ('Fast Register Stack').

This exception can be overridden by placing an `asm RETFIE, 0` instruction at the end of the high priority interrupt routine (with redirecting all routine exits to this instruction).

Thus, `#pragma disablecontexsaving` pragma enables the user to manually write code for saving registers upon entrance and to restore them before exit from interrupt.

Interrupt Handling

For the sake of interrupt handling convenience, new keyword, `iv`, is introduced. It is used to declare Interrupt Vector Table (IVT) address for a defined interrupt routine :

```
void int1() iv IVT_ADDR_U1RXINTERRUPT{  
    asm nop;  
}
```

Now it is possible to explicitly declare interrupt routine address :

```
void int1() org 0x600 iv IVT_ADDR_U1RXINTERRUPT {  
    asm nop;  
}
```

For the sake of backward compatibility, user may write also :

```
void int1() org IVT_ADDR_U1RXINTERRUPT {  
    asm nop;  
}
```

which is equivalent to :

```
void int1() iv IVT_ADDR_U1RXINTERRUPT {  
    asm nop;  
}
```

Is is recommended that interrupts are handled in this way for the sake of better readability of the user projects.

Interrupt Example

Here is a simple example of handling the interrupts from `Timer1` (if no other interrupts are allowed):

```
// Interrupt routine  
void Timer1Int() iv IVT_ADDR_T1INTERRUPT {  
    /** it is necessary to clear manually the interrupt flag:  
    IFS0 = IFS0 & 0xFFF7;    // Clear TMR1IF  
  
    /** user code starts here  
    LATB = ~ PORTB;        // Invert PORTB  
    /** user code ends here  
}
```

Linker Directives

The mikroC PRO for dsPIC30/33 and PIC24 uses an internal algorithm to distribute objects within memory. If you need to have a variable or routine at specific predefined address, use the linker directives `absolute` and `org`.

Directive `absolute`

Directive `absolute` specifies the starting address in RAM for a variable or a starting address in ROM for a constant. If the variable or constant is multi-byte, higher bytes will be stored at the consecutive locations.

Directive `absolute` is appended to declaration of a variable or constant :

```
// Variable x will occupy 1 byte at address 0x22 :  
short x absolute 0x22;  
  
// Variable y will occupy 2 bytes at addresses 0x23 and 0x24 :  
int y absolute 0x23;  
  
// Array elements will be placed on the consecutive locations starting from 0x1000 :  
const short ConstantArray[] = {1,2,3} absolute 0x1000;
```

Note :

If you want to place simple type constant into Flash memory, instead of following declaration:

```
const short SimpeConstant = 0xAA absolute 0x2000;
```

use an array consisting of single element :

```
const short SimpleConstant[] = {0xAA} absolute 0x2000;
```

In first case, compiler will recognize your attempt, but in order to save Flash space, and boost performance, it will automatically replace all instances of this constant in code with it's literal value.

In the second case your constant will be placed in Flash in the exact location specified.

Be careful when using the `absolute` directive, as you may overlap two variables by accident. For example:

```
// Variable i will occupy 1 byte at address 0x33  
char i absolute 0x33;  
  
// Variable will occupy 4 bytes at 0x30, 0x31, 0x32, 0x33; thus,  
// changing i changes jjjj highest byte at the same time, and vice versa  
long jjjj absolute 0x30;
```

Directive `orgall`

If the user wants to place his routines, constants, etc, above a specified address in ROM, `#pragma orgall` directive should be used:

```
#pragma orgall 0x200
```

Directive funcorg

You can use the `#pragma funcorg` directive to specify the starting address of a routine in ROM using routine name only:

```
#pragma funcorg <func_name> <starting_address>
```

Related topics: Indirect Function Calls

Indirect Function Calls

If the linker encounters an indirect function call (by a pointer to function), it assumes that any of the functions addresses of which were taken anywhere in the program, can be called at that point. Use the `#pragma funcall` directive to instruct the linker which functions can be called indirectly from the current function:

```
#pragma funcall <func_name> <called_func>[, <called_func>,...]
```

A corresponding pragma must be placed in the source module where the function `func_name` is implemented. This module must also include declarations of all functions listed in the `called_func` list.

These functions will be linked if the function `func_name` is called in the code no matter whether any of them was called or not.

Note : The `#pragma funcall` directive can help the linker to optimize function frame allocation in the compiled stack.

Related topics: Linker Directives

Built-in Routines

The mikroC PRO for dsPIC30/33 and PIC24 compiler provides a set of useful built-in utility functions.

The `Lo`, `Hi`, `Higher`, `Highest`, `LoWord`, `HiWord` routines are implemented as macros. If you want to use these functions you must include `built_in.h` header file (located in the `include` folder of the compiler) into your project.

The `Delay_us` and `Delay_ms` routines are implemented as “inline”; i.e. code is generated in the place of a call, so the call doesn't count against the nested call limit.

The `Vdelay_ms`, `Vdelay_advanced_ms`, `Delay_Cyc`, `Delay_Cyc_Long`, `Get_Fosc_kHz` and `Get_Fosc_Per_Cyc` are actual C routines. Their sources can be found in `Delays.c` file located in the `uses` folder of the compiler.

- `Lo`
- `Hi`
- `Higher`
- `Highest`

- `LoWord`
- `HiWord`

- `Delay_us`
- `Delay_ms`
- `Vdelay_ms`
- `Vdelay_Advanced_ms`
- `Delay_Cyc`
- `Delay_Cyc_Long`

- `Clock_kHz`
- `Clock_MHz`
- `Get_Fosc_kHz`
- `Get_Fosc_Per_Cyc`

Lo

Prototype	<code>#define Lo(param) ((char *)&param)[0]</code>
Description	The function returns low byte of <code>number</code> . The function does not interpret bit patterns of <code>number</code> – it merely returns 8 bits as found in register. This is an “inline” routine; code is generated in the place of the call, so the call doesn’t count against the nested call limit.
Parameters	<code>number</code> : input number
Returns	Low byte of <code>number</code> , bits 7..0.
Requires	Nothing.
Example	<pre>d = 0x12345678; tmp = Lo(d); // Equals 0x78 Lo(d) = 0xAA; // d equals 0x123456AA</pre>
Notes	None.

Hi

Prototype	<code>#define Hi(param) ((char *)&param)[1]</code>
Description	The function returns high byte of <code>number</code> . The function does not interpret bit patterns of <code>number</code> – it merely returns 8 bits as found in register. This is an “inline” routine; code is generated in the place of the call, so the call doesn’t count against the nested call limit.
Parameters	<code>number</code> : input number
Returns	High byte of <code>number</code> , bits 15..8.
Requires	Nothing.
Example	<pre>d = 0x12345678; tmp = Hi(d); // Equals 0x56 Hi(d) = 0xAA; // d equals 0x1234AA78</pre>
Notes	None.

Higher

Prototype	<code>#define Higher(param) ((char *)&param)[2]</code>
Description	<p>The function returns higher byte of <code>number</code>. The function does not interpret bit patterns of <code>number</code> – it merely returns 8 bits as found in register.</p> <p>This is an “inline” routine; code is generated in the place of the call, so the call doesn’t count against the nested call limit.</p>
Parameters	<code>number</code> : input number
Returns	Higher byte of <code>number</code> , bits 23..16.
Requires	Nothing.
Example	<pre>d = 0x12345678; tmp = Higher(d); // Equals 0x34 Higher(d) = 0xAA; // d equals 0x12AA5678</pre>
Notes	None.

Highest

Prototype	<code>#define Highest(param) ((char *)&param)[3]</code>
Description	<p>The function returns highest byte of <code>number</code>. The function does not interpret bit patterns of <code>number</code> – it merely returns 8 bits as found in register.</p> <p>This is an “inline” routine; code is generated in the place of the call, so the call doesn’t count against the nested call limit.</p>
Parameters	<code>number</code> : input number
Returns	Highest byte of <code>number</code> , bits 31..24.
Requires	Nothing.
Example	<pre>d = 0x12345678; tmp = Highest(d); // Equals 0x12 Highest(d) = 0xAA; // d equals 0xAA345678</pre>
Notes	None.

LoWord

Prototype	<code>unsigned int LoWord(unsigned long number);</code>
Description	The function returns low word of <code>number</code> . The function does not interpret bit patterns of <code>number</code> – it merely returns 16 bits as found in register. This is an “inline” routine; code is generated in the place of the call, so the call doesn’t count against the nested call limit.
Parameters	<code>number</code> : input number
Returns	Low word of <code>number</code> , bits 15..0.
Requires	Nothing.
Example	<pre>d = 0x12345678; tmp = LoWord(d); // Equals 0x5678 LoWord(d) = 0xAAAA; // d equals 0x1234AAAA</pre>
Notes	None.

HiWord

Prototype	<code>unsigned int HiWord(unsigned long number);</code>
Description	The function returns high word of <code>number</code> . The function does not interpret bit patterns of <code>number</code> – it merely returns 16 bits as found in register. This is an “inline” routine; code is generated in the place of the call, so the call doesn’t count against the nested call limit.
Parameters	<code>number</code> : input number
Returns	High word of <code>number</code> , bits 31..16.
Requires	Nothing.
Example	<pre>d = 0x12345678; tmp = HiWord(d); // Equals 0x1234 HiWord(d) = 0xAAAA; // d equals 0xAAAA5678</pre>
Notes	None.

Delay_us

Prototype	<code>void Delay_us(const unsigned long time_in_us);</code>
Description	Creates a software delay in duration of <code>time_in_us</code> microseconds. This is an “inline” routine; code is generated in the place of the call, so the call doesn’t count against the nested call limit.
Parameters	<code>time_in_us</code> : delay time in microseconds. Valid values: constant values, range of applicable constants depends on the oscillator frequency
Returns	Nothing.
Requires	Nothing.
Example	<code>Delay_us(10); /* Ten microseconds pause */</code>
Notes	None.

Delay_ms

Prototype	<code>void Delay_ms(const unsigned int time_in_ms);</code>
Description	Creates a software delay in duration of <code>time_in_ms</code> milliseconds. This is an “inline” routine; code is generated in the place of the call, so the call doesn’t count against the nested call limit.
Parameters	<code>time_in_ms</code> : delay time in milliseconds. Valid values: constant values, range of applicable constants depends on the oscillator frequency
Returns	Nothing.
Requires	Nothing.
Example	<code>Delay_ms(1000); /* One second pause */</code>
Notes	For generating delays with variable as input parameter use the <code>Vdelay_ms</code> routine.

Vdelay_ms

Prototype	<code>void Vdelay_ms(unsigned Time_ms);</code>
Description	Creates a software delay in duration of <code>Time_ms</code> milliseconds. Generated delay is not as precise as the delay created by <code>Delay_ms</code> .
Parameters	<code>Time_ms</code> : delay time in milliseconds
Returns	Nothing.
Requires	Nothing.
Example	<code>unsigned pause = 1000; ... Vdelay_ms(pause); // ~ one second pause</code>
Notes	<code>Vdelay_ms</code> is a library function rather than a built-in routine; it is presented in this topic for the sake of convenience.

VDelay_Advanced_ms

Prototype	<code>void VDelay_Advanced_ms(unsigned time_in_ms, unsigned Current_Fosc_kHz);</code>
Description	Creates a software delay in duration of <code>time_in_ms</code> milliseconds (a variable), for a given oscillator frequency. Generated delay is not as precise as the delay created by <code>Delay_ms</code> .
Parameters	<code>Time_ms</code> : delay time in milliseconds <code>Current_Fosc_kHz</code> : desired oscillator frequency
Returns	Nothing.
Requires	Nothing.
Example	<pre>pause = 1000; fosc = 10000; VDelay_Advanced_ms(pause, fosc); // Generates approximately one second pause, for a oscillator frequency of 10 MHz</pre>
Notes	Note that <code>VDelay_Advanced_ms</code> is library function rather than a built-in routine; it is presented in this topic for the sake of convenience.

Delay_Cyc

Prototype	<code>void Delay_Cyc(unsigned int x, unsigned int y);</code>
Description	Creates a delay based on MCU clock. Delay lasts for $x \cdot 16384 + y$ MCU clock cycles.
Parameters	<code>x</code> : NumberOfCycles divided by 16384 <code>y</code> : remainder of the NumberOfCycles/16384 division
Returns	Nothing.
Requires	Nothing.
Example	<pre>Delay_Cyc(1, 10); /* 1x16384 + 10 = 16394 cycles pause */</pre>
Notes	<code>Delay_Cyc</code> is a library function rather than a built-in routine; it is presented in this topic for the sake of convenience.

Delay_Cyc_Long

Prototype	<code>void Delay_Cyc_Long(unsigned long CycNo);</code>
Description	Creates a delay based on MCU clock. Delay lasts for <code>CycNo</code> MCU clock cycles.
Parameters	<code>CycNo</code> : number of cycles
Returns	Nothing.
Requires	Nothing.
Example	<pre>Delay_Cyc_Long(16394); // 16394 cycles pause</pre>
Notes	<code>Delay_Cyc_Long</code> is a library function rather than a built-in routine; it is presented in this topic for the sake of convenience.

Clock_kHz

Prototype	<code>unsigned long Clock_kHz();</code>
Description	Function returns device clock in kHz, rounded to the nearest integer. This is an “inline” routine; code is generated in the place of the call, so the call doesn’t count against the nested call limit.
Parameters	None.
Returns	Device clock in kHz, rounded to the nearest integer.
Requires	Nothing.
Example	<pre>unsigned long clk; ... clk = Clock_kHz();</pre>
Notes	None.

Clock_Mhz

Prototype	<code>unsigned long Clock_MHz();</code>
Description	Function returns device clock in MHz, rounded to the nearest integer. This is an “inline” routine; code is generated in the place of the call, so the call doesn’t count against the nested call limit.
Parameters	None.
Returns	Device clock in MHz, rounded to the nearest integer.
Requires	Nothing.
Example	<pre>unsigned long clk; ... clk = Clock_MHz();</pre>
Notes	None.

Get_Fosc_kHz

Prototype	<code>unsigned long Get_Fosc_kHz();</code>
Description	Function returns device clock in kHz, rounded to the nearest integer. Note that Get_Fosc_kHz is library function rather than a built-in routine; it is presented in this topic for the sake of convenience.
Parameters	None.
Returns	Device clock in kHz, rounded to the nearest integer.
Requires	Nothing.
Example	<pre>unsigned long clk; ... clk = Get_Fosc_kHz();</pre>
Notes	None.

Get_Fosc_Per_Cyc

Prototype	<code>unsigned int Get_Fosc_Per_Cyc();</code>
Description	Function returns device's clock per cycle, rounded to the nearest integer. Note that <code>Get_Fosc_Per_Cyc</code> is library function rather than a built-in routine; it is presented in this topic for the sake of convenience.
Parameters	None.
Returns	Device's clock per cycle, rounded to the nearest integer.
Requires	Nothing.
Example	<pre>unsigned int clk_per_cyc; ... clk_per_cyc = Get_Fosc_Per_Cyc();</pre>
Notes	None.

Code Optimization

Optimizer has been added to extend the compiler usability, cut down the amount of code generated and speed-up its execution. The main features are:

Constant folding

All expressions that can be evaluated in the compile time (i.e. constant) are being replaced by their results. (3 + 5 -> 8);

Constant propagation

When a constant value is being assigned to a certain variable, the compiler recognizes this and replaces the use of the variable by constant in the code that follows, as long as the value of a variable remains unchanged.

Copy propagation

The compiler recognizes that two variables have the same value and eliminates one of them further in the code.

Value numbering

The compiler "recognizes" if two expressions yield the same result and can therefore eliminate the entire computation for one of them.

"Dead code" elimination

The code snippets that are not being used elsewhere in the programme do not affect the final result of the application. They are automatically removed.

Stack allocation

Temporary registers ("Stacks") are being used more rationally, allowing VERY complex expressions to be evaluated with a minimum stack consumption.

Local vars optimization

No local variables are being used if their result does not affect some of the global or volatile variables.

Better code generation and local optimization

Code generation is more consistent and more attention is payed to implement specific solutions for the code "building bricks" that further reduce output code size.

Related topics: SSA Optimization, dsPIC specifics, mikroC PRO for dsPIC30/33 and PIC24 specifics, Memory type specifiers

Single Static Assignment Optimization

Introduction

In compiler design, static single assignment form (often abbreviated as SSA form or SSA) is an intermediate representation (IR) in which every variable is assigned exactly once.

An SSA-based compiler modifies the program representation so that every time a variable is assigned in the original program, a new version of the variable is created.

A new version of the variable is distinguished (renamed) by subscripting the variable name with its version number or an index, so that every definition of each variable in a program becomes unique.

At a joining point of the control flow graph where two or more different definitions of a variable meet, a hypothetical function called a phi-function is inserted so that these multiple definitions are merged.

In mikroC PRO for dsPIC, SSA's main goal is in allocating local variables into the RX space (instead onto the frame). To do that, SSA has to make an alias and data flow analysis of the Control Flow Graph.

Besides these savings, there are a number of compiler optimization algorithms enhanced by the use of SSA, like :

- Constant Propagation
- Dead Code Elimination
- Global Value Numbering
- Register Allocation

Changes that SSA brings is also in the way in which routine parameters are passed. When the SSA is enabled, parameters are passed through a part of the RX space which is reserved exclusively for this purpose (W10-W13 for dsPIC).

Allocating local variables and parameters in RX space has its true meaning for those architectures with hardware frame.

Enabling SSA optimization in compiler is done by checking `Enable SSA optimization` box from the Output Settings Menu.

Lets consider a trivial case :

```
void main() {
    int y,k;

    if(y+k)
        asm nop;
}
```

With SSA enabled, this example is consisted of 3 asm instructions :

```
;rbuild.c,10 ::          if(y+k)
0x0212 0x408002          ADD    _WREG1, _WREG2, _WREG0
0x0214 0x320001          BRA   Z  L_main0
L_main2:
;rbuild.c,11 ::          asm nop;
0x0216 0x000000          NOP
```

Without SSA enabled, this example is consisted of 5 asm instructions :

```
;rbuild.c,10 ::          if(y+k)
0x0218 0x90008E          MOV    [_WREG14+0], _WREG1
0x021A 0x470062          ADD    _WREG14, #2, _WREG0
0x021C 0x408010          ADD    _WREG1, [_WREG0], _WREG0
0x021E 0x320001          BRA   Z  L_main0
L_main2:
;rbuild.c,11 ::          asm nop;
0x0220 0x000000          NOP
```

Proper Coding Recommendations

To get the maximum out of the SSA, user should regard the following rules during the coding process :

- Routines should not contain too many parameters (not more than 4 words).
- Don't change the value of the parameter in the function body (it is better to use a new local variable).
- If the `function1` parameters are passed as `function2` parameters, then parameter order should remain the same :

```
f2(int a, int b) { }

f1(int x, int y) {
    // routine call
    f2(x,y); // x->a and y->b (1 to 1 and 2 to 2) is far more efficient than :
    f2(y,x); // y->a and x->b (1 to 2 and 2 to 1)
}
```

- Large amount of nested loops and complex structures as its members should be avoided.
- When writing a code in assembly, keep in mind that there are registers reserved exclusively for routine parameters.
- Using `goto` and `label` statements in nested loops should be avoided.
- Obtaining address of the local variable with the global pointer and using it to alter the variable's address should be avoided.

Notes :

- `mcl` files compiled with or without SSA enabled are fully compatible and can be used and mixed without any restrictions, except function pointers.
- All function prototypes and function pointers have to be built using the same optimizer because of different calling conventions in different optimizers. In SSA, function parameters are passed via working registers, and without SSA they end up on the function frame.
- This means that you cannot have a function implementation which is optimized using SSA optimizer, and to call this function via function pointer in another module which is optimized using NON-SSA.
When using pointers to functions, compiler must know exactly how to pass function parameters and how to execute function call.

Asm code and SSA optimization

If converting code from an earlier version of the compiler, which consists of mixed asm code with the C code, keep in mind that the generated code can substantially differ when SSA optimization option is enabled or disabled.

This is due to the fact that SSA optimization uses certain working registers to store routine parameters (W10-W13), rather than storing them onto the function frame.

Because of this, user must be very careful when writing asm code as existing values in the working registers used by SSA optimization can be overwritten.

To avoid this, it is recommended that user includes desired asm code in a separate routine.

Debugging Notes

SSA also influences the code debugging in such a way that the local variables will be available in the Watch Window only in those parts of the procedure where they have useful value (eg. on entering the procedure, variable isn't available until its definition).

Variables can be allocated in one part of the procedure in register W4, and in another part of the procedure in register W2, if the optimizer estimates that it is better that way. That means that the local variable has no static address.

Warning Messages Enhancement

Besides the smaller code, SSA also deals with the intensive code analysis, which in turn has the consequence in enhancing the warning messages.

For example, compiler will warn the user that the uninitialized variable is used :

```
void main() {  
    int y;  
  
    if (y)          // Variable y might not have been initialized  
        PORTD = 0;  
}
```

Related topics: Code Optimization, dsPIC Specifics, mikroC PRO for dsPIC30/33 and PIC24 specifics, Memory type specifiers

Common Object File Format (COFF)

COFF File Format

The Common Object File Format (COFF) is a specific file format suitable for code debugging. The COFF incorporates symbolic procedure, function, variable and constant names information; line number information, breakpoints settings, code highlighter and all the necessary information for effective and fast debugging.

By using COFF, it is possible to import and debug code generated by mikroElektronika compilers under Microchip's MPLAB®.

COFF File Generation

1. Start mikroC PRO for dsPIC30/33 and PIC24 and open the desired project. For example, UART project for EasydsPIC4A board and dsPIC30F4013 will be opened :

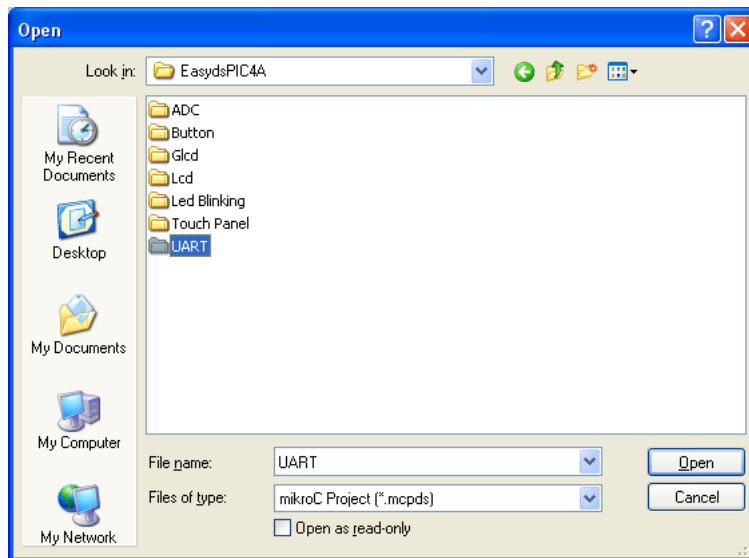

2. When the project is opened, go to **Tools > Options > Output settings**, and check the "Generate COFF file" option, and click the OK button :

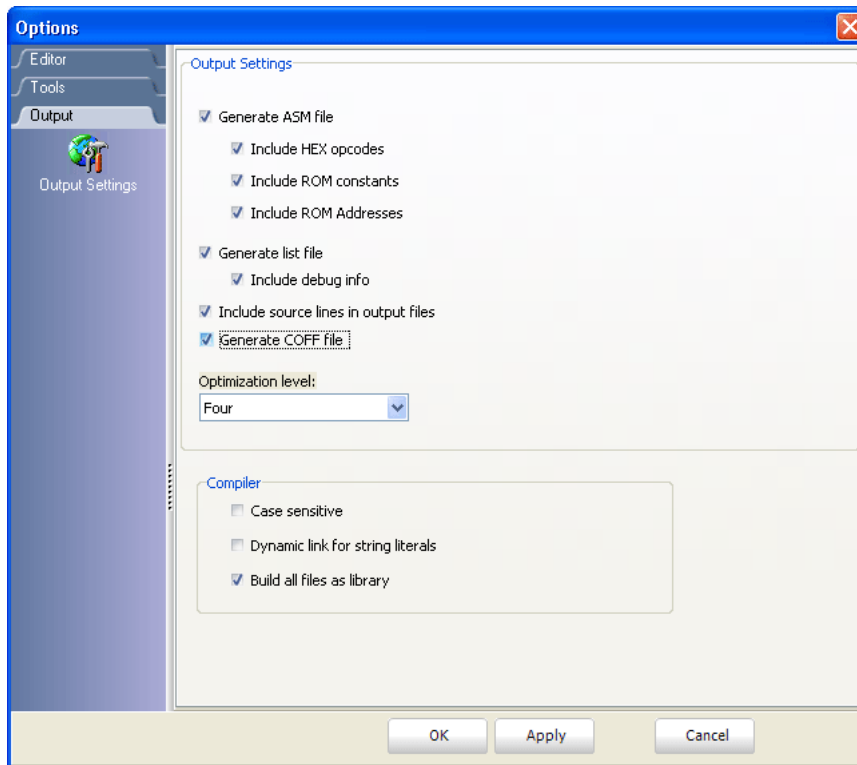

3. Now, compile the project. In the messages window, appropriate message on COFF file generation should appear :

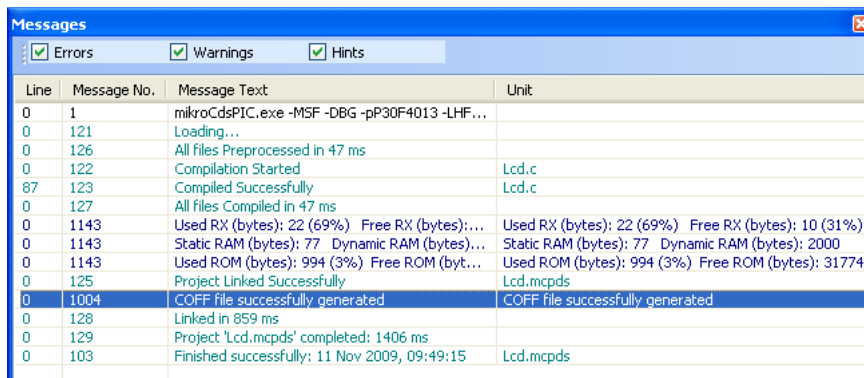

4. Generated COFF file will be created in the project folder, with the `.cof` extension.

Related topics: Using MPLAB® ICD 2 Debugger, Using MPLAB® Simulator

CHAPTER 7

dsPIC30/33 and PIC24 Specifics

In order to get the most from the mikroC PRO for dsPIC30/33 and PIC24 compiler, the user should be familiar with certain aspects of dsPIC30/33 and PIC24 MCU. This knowledge is not essential, but it can provide a better understanding of the dsPIC30/33 and PIC24's capabilities and limitations, and their impact on the code writing as well.

Types Efficiency

First of all, the user should know that dsPIC30/33 and PIC24's ALU, which performs arithmetic operations, is optimized for working with 16-bit types. Although mikroC PRO for dsPIC30/33 and PIC24 is capable of handling types like char or short, dsPIC30/33 and PIC24 will generate a better code for 16-bit types, like int. Therefore, use char and short only in places where you can significantly save RAM (e.g. for arrays char a[30]).

Nested Calls Limitations

There are no Nested Calls Limitations, except by RAM size. A Nested call represents a function call within the function body, either to itself (recursive calls) or to another function.

Recursive calls, as a form of cross-calling, are supported by mikroC PRO for dsPIC30/33 and PIC24, but they should be used very carefully due to dsPIC30/33 and PIC24 stack and memory limitations. Also calling functions from interrupt is allowed. Calling function from both interrupt and main thread is allowed. Be carefull because this programming technique may cause unpredictable results if common resources are used in both main and interrupt.

Limits of Indirect Approach Through PSV

Constant aggregates are stored in Flash and are accessible through PSV. mikroC PRO for dsPIC30/33 and PIC24 can allocate more than 32KByte of constants. See near and far memory specifiers.

Limits of Pointer to Function

Currently pointer to functions are 16-bit variables. For functions which address exceeds 16 bit limit, the compiler uses handle (16-bit pointer on GOTO). A handle usage is automatic compiler process so there is no need for the user to intervene.

Variable, constant and routine alignment

Simple type variables whose size exceeds 1 byte (int, long, float, double, long double) are always set to alignment 2 (i.e. are always allocated on even address).

Derived types and constant aggregates whose at least one element exceeds size of 1 byte are set to alignment 2.

Routines are always set to alignment 2.

dsPIC Memory Organization

The dsPIC microcontroller's memory is divided into Program Memory and Data Memory. Program Memory (ROM) is used for permanent saving program being executed, while Data Memory (RAM) is used for temporarily storing and keeping intermediate results and variables.

Program Memory (ROM)

Program Memory (ROM) is used for permanent saving program code being executed, and it is divided into several sections, as on the picture below. The size of these sections is device dependant.

The program memory map is divided into the User Memory Space and Configuration Memory Space. The User Memory Space contains the Reset vector, interrupt vector tables, program memory and data EEPROM memory (dsPIC30 family and some PIC24 family MCU's).

The Configuration Memory Space contains non-volatile configuration bits for setting device options and the device ID locations.

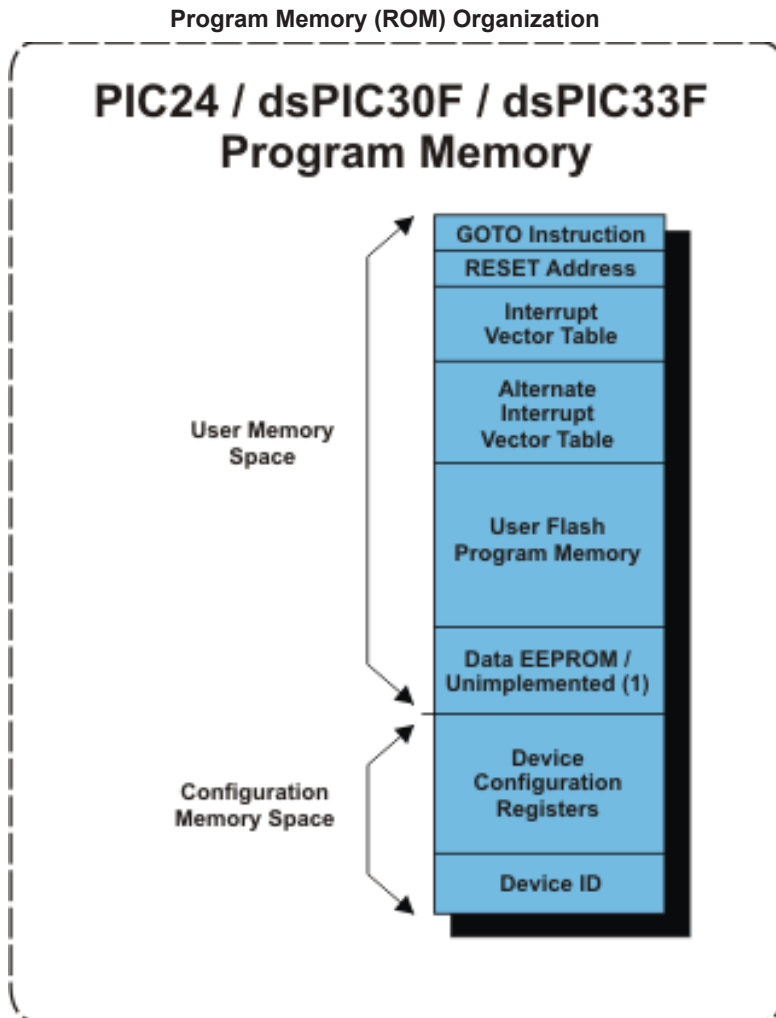

1. dsPIC33F Program Memory Organization

Data Memory (RAM)

Data memory consists of:

- SFR Memory Space
- X and Y Data RAM
- DMA RAM (only for dsPIC33F Family)
- Unimplemented Memory Space

Data Memory (RAM) Organization

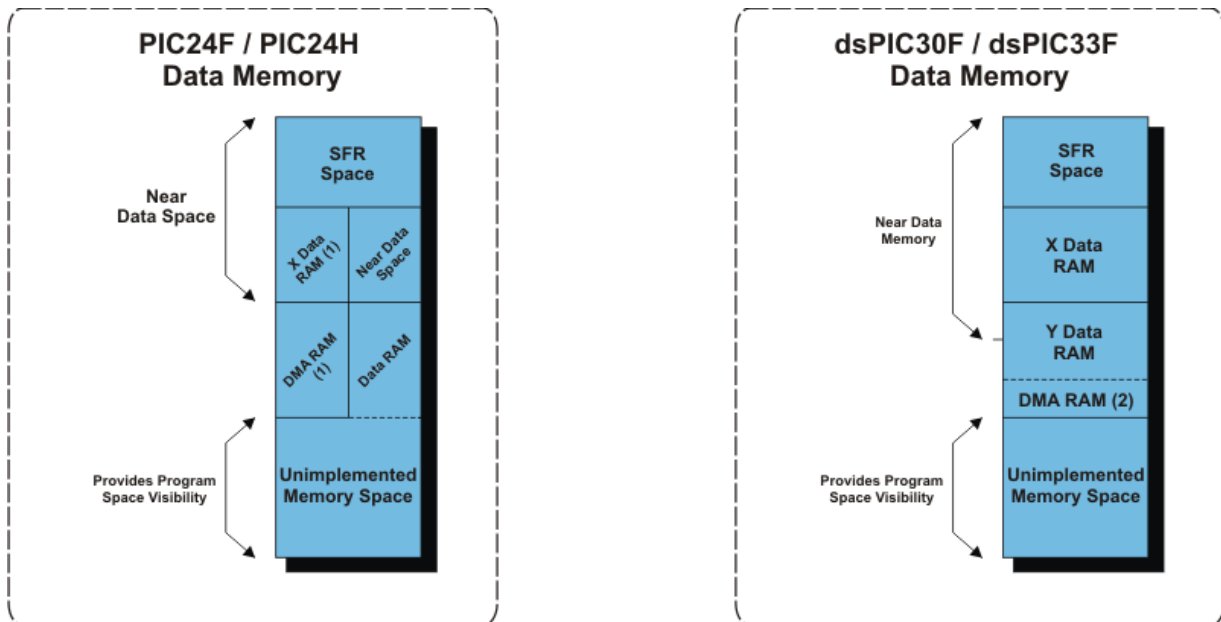

1. PIC24F Data Memory Organization
2. dsPIC33F Data Memory Organization

SFR Memory Space

The first 2kB of data memory is allocated to the Special Function Registers (SFRs). The SFRs are control and status register for core and peripheral functions in the dsPIC.

X and Y Data RAM

Up to 8 kB of data RAM is implemented after the SFRs. This is general purpose RAM that can be used for data storage. This RAM is split into X and Y memory for dsPIC instructions.

This allows DSP instructions to support dual operand reads, so that data can be fetched from X and Y memory space at the same time for a single instruction.

The X and Y data space boundary is fixed for any given device. When not doing DSP instructions, the memory is all treated as a single block of X memory.

DMA RAM

Every dsPIC33F device contains a portion of dual ported DMA RAM located at the end of Y data space. Direct Memory Access (DMA) is a very efficient mechanism of copying data between peripheral SFRs and buffers or variables stored in RAM, with minimal CPU intervention.

The DMA controller can automatically copy entire blocks of data without requiring the user software to read or write the peripheral Special Function Registers (SFRs) every time a peripheral interrupt occurs.

The DMA controller uses a dedicated bus for data transfers and therefore, does not steal cycles from the code execution flow of the CPU. To exploit the DMA capability, the corresponding user buffers or variables must be located in DMA RAM.

Unimplemented Memory Space

The last segment of data RAM space is not implemented, but can be mapped into program space for Program Space Visibility. This allows program memory to be read as though it were in data RAM.

Notes:

- Boundaries between memory spaces are device specific. Please, refer to the appropriate datasheet for details.
- Memory spaces are not shown to scale. Please, refer to the appropriate datasheet for details.

There are seven memory type specifiers that can be used to refer to the data memory: `rx`, `data`, `code`, `sfr`, `xdata`, `ydata`, and `dma`

Related topics: Accessing individual bits, SFRs, Memory type specifiers, dsPIC Memory Type QualifiersC

Memory Type Specifiers

The mikroC PRO for dsPIC30/33 and PIC24 supports usage of all memory areas.

Each variable may be explicitly assigned to a specific memory space by including a memory type specifier in the declaration, or implicitly assigned.

The following memory type specifiers can be used:

- code
- data
- rx
- sfr
- xdata
- ydata
- dma

code

Description	The <code>code</code> memory type may be used for allocating constants in program memory.
Example	<pre>// puts txt in program memory const code char txt[] = "ENTER PARAMETER:";</pre>

data

Description	This memory specifier is used when storing variable to the Data RAM.
Example	<pre>// puts x in data ram data unsigned char x;</pre>

rx

Description	This memory specifier allows variable to be stored in the working registers space (WREG0-WREG15).
Example	<pre>// puts y in working register space rx char y;</pre>

sfr

Description	This memory specifier allows user to access special function registers. It also instructs compiler to maintain same identifier in source and assembly.
Example	<pre>sfr char y; // puts y in SFR space</pre>

xdata

Description	This memory specifier allows user to access X Data memory space.
Example	<code>xdata char x; // puts x in xdata memory space</code>

ydata

Description	This memory specifier allows user to access Y Data memory space.
Example	<code>ydata char y; // puts y in ydata memory space</code>

dma

Description	This memory specifier allows user to access DMA memory space (dsPIC33F specific).
Example	<code>dma char y; // puts y in DMA memory space</code>

Note: If none of the memory specifiers are used when declaring a variable, data specifier will be set as default by the compiler.

Related topics: dsPIC Memory Organization, dsPIC Memory Type Qualifiers, Accessing individual bits, SFRs, Constants, Functions

Memory Type Qualifiers

In addition to the standard storage qualifiers(`const`, `volatile`) the compiler introduces storage qualifiers of `near` and `far`.

Near Memory Qualifier

1. Data Memory Objects

The qualifier `near` is used to denote that a variable is allocated in near data space (the first 8 kB of Data memory). Such variables can sometimes be accessed more efficiently than variables not allocated (or not known to be allocated) in near data space.

If variables are allocated in the near data section, the compiler is often able to generate better (more compact) code than if the variables are not allocated in the near data section.

2. Program Memory Objects

The qualifier `near` is used to denote that a constant is allocated in the default program memory page (32kB segment of program memory). Default program memory page is the one with most free space and is set by the compiler by analyzing program memory pages.

This qualifier is set as default by the compiler, if no other qualifier is used.

Far Memory Qualifier

1 Data Memory Objects

The qualifier `far` is used to denote that a variable will not be in near data space (i.e. the variable can be located anywhere in data memory). This qualifier is set as default by the compiler, if no other qualifier is used.

2. Program Memory Objects

The qualifier `far` is used to denote that a constant can be allocated anywhere in the program memory, in the page pointed to by PSVPAG register.

Location of object based on memory qualifiers:

Qualifier/Memory	Data Memory	Program Memory
<code>near</code>	First 8 kB of RAM	In default page
<code>far</code>	Anywhere in RAM	In page pointed to PSVPAG register

Example:

```
char i;           // far memory qualifier is set, variable i can allocated somewhere in data memory
char near j;     // near memory qualifier is set, variable j will be allocated in the first 8kB of data memory
const int k = 10; // near memory qualifier is set, constant k will be allocated in the default memory page
```

Related topics: dsPIC Memory Organization, dsPIC Memory Type Specifiers

Read Modify Write Problem

The Microchip microcontrollers use a sequence known as **Read-Modify-Write** (RMW) when changing an output state (1 or 0) on a pin. This can cause unexpected behavior under certain circumstances.

When your program changes the state on a specific pin, for example RB0 in PORTB, the microcontroller first **READs** all 8 bits of the PORTB register which represents the states of all 8 pins in PORTB (RB7-RB0). The microcontroller then stores this data in the MCU. The bit associated with RB that you've commanded to **MODIFY** is changed, and then the microcontroller **WRITES** all 8 bits (RB7-RB0) back to the PORTB register.

During the first reading of the PORT register, you will be reading the actual state of the physical pin. The problem arises when an output pin is loaded in such a way that its logic state is affected by the load. Instances of such loads are LEDs without current-limiting resistors or loads with high capacitance or inductance.

For example, if a capacitor is attached between pin and ground, it will take a short while to charge when the pin is set to 1. On the other hand, if the capacitor is discharged, it acts like a short circuit, forcing the pin to '0' state, and, therefore, a read of the PORT register will return 0, even though we wrote a 1 to it.

Lets analyze the following example:

```
PORTB.B0 = 1;  
PORTB.B1 = 1;
```

Assume that the PORTB is initially set to zero, and that all pins are set to output. Let's say we connect a discharged capacitor to RB0 pin.

The first line, `PORTB.B0 = 1;` will be decoded like in this way:

READ PORTB is read:

STORE Data is stored inside a temporary internal register in the MCU :

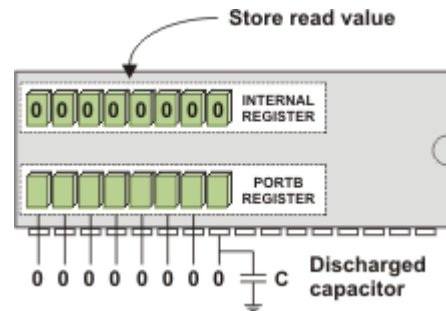
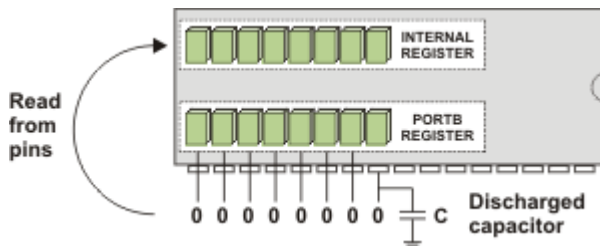

Actual voltage levels on MCU pins are relevant.

MODIFY Data is **modified** to set the RB0 bit:

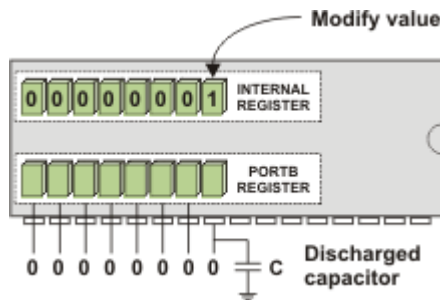

WRITE PORTB is **written** with the modified data. The output driver for RB0 turns on, and the capacitor starts to charge:

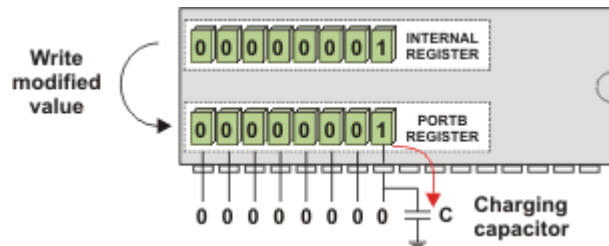

The second line, `PORTB.B1 = 1;` will be decoded like in this way:

READ PORTB is **read**:

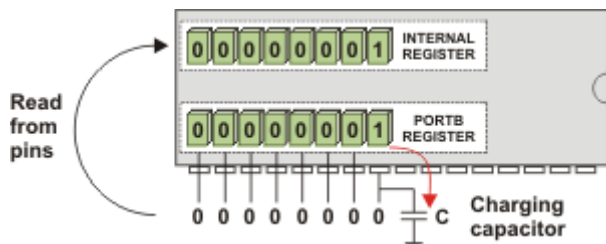

STORE Because the capacitor is still charging, the voltage at RB0 is still low and reads as a '0' (since we are reading from the pins directly, not from the PORTB register) :

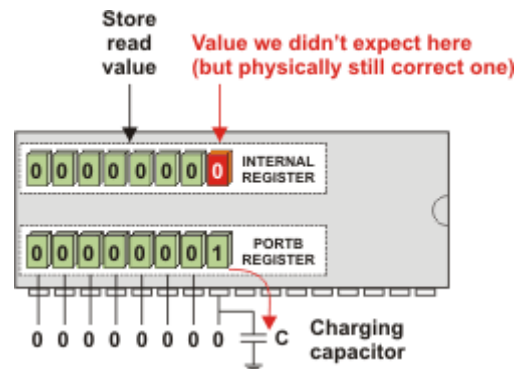

Actual voltage levels on MCU pins are relevant.

MODIFY Data is **modified** to set the bit:

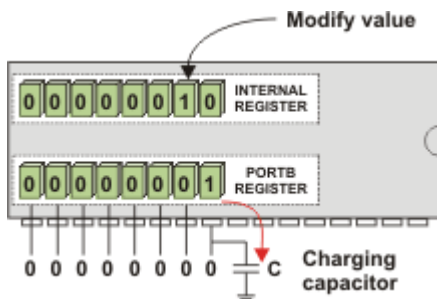

WRITE PORTB is **written** with the new data. The output driver for RB1 turns on, **but the driver for RB0 turns back off**:

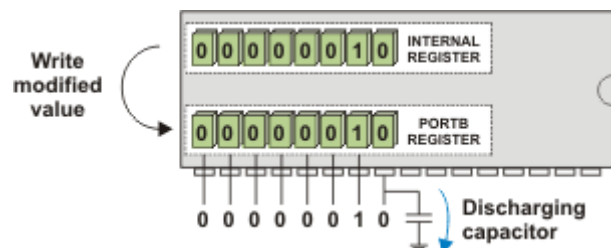

To correct the problem in the code, insert a delay after each `PORTB.Bx = 1` line, or modify the entire PORTB register in a single line `PORTB = 0b00000011`.

This problem can be avoided by using LATx register when writing to ports, rather than using PORTx registers. Writing to a LATx register is equivalent to writing to a PORTx register, **but readings from LATx registers return the data value held in the port latch, regardless of the state of the actual pin.**

For example, lets analyze the following example:

```
LATB.B0 = 1;
LATB.B1 = 1;
```

The first line, `LATB.B0 = 1`; will be decoded like in this way:

READ LATB is read:

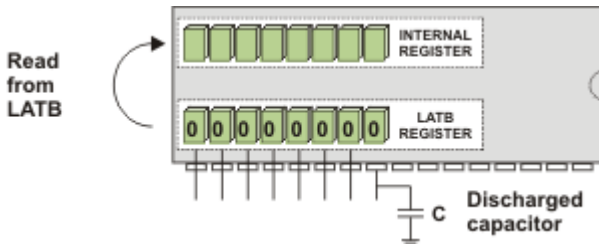

STORE Data is stored inside a temporary internal register in the MCU :

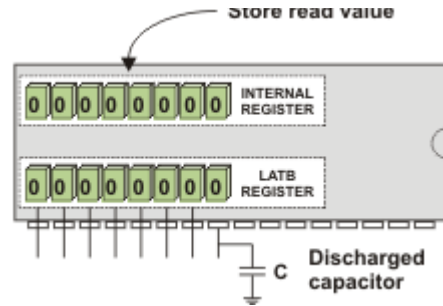

Actual voltage levels on MCU pins are no longer relevant when using LATx for output

MODIFY Data is **modified** to set the RB0 bit:

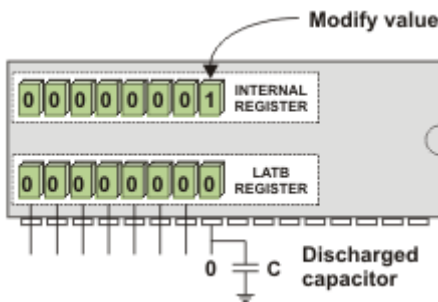

WRITE LATB is **written** with the modified data. The output driver for RB0 turns on, and the capacitor starts to charge:

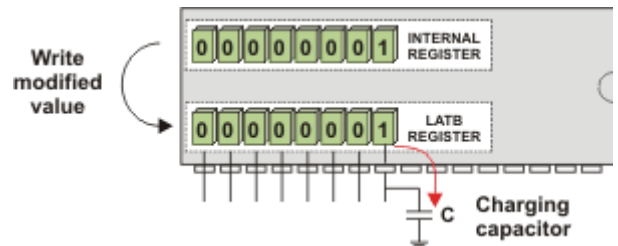

The second line, `LATB.B1 = 1;` will be decoded like in this way :

READ LATB is read:

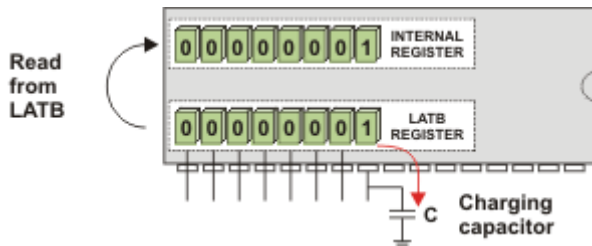

STORE Since the voltage levels on MCU pins are no longer relevant, we get the expected value:

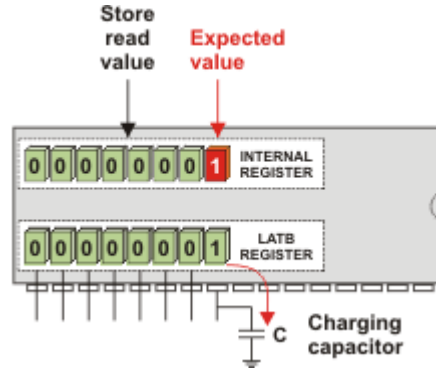

Actual voltage levels on MCU pins are no longer relevant when using LATx for output

MODIFY Data is modified to set the bit:

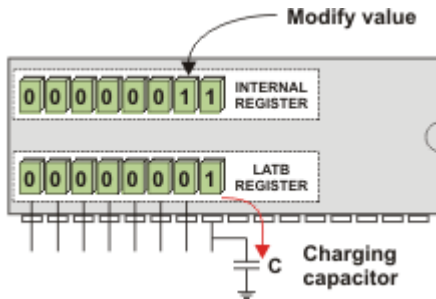

WRITE LATB is written with the new data. The output driver for RB1 turns on, and the output driver for RB0 remains turned on:

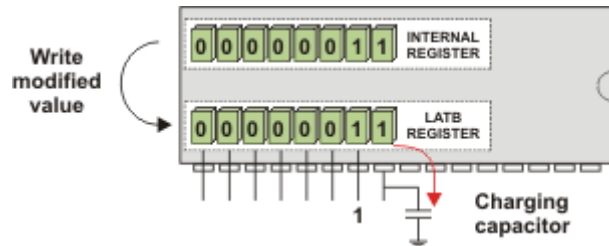

When to use LATx instead of PORTx

Depending on your hardware, one may experience unpredictable behavior when using PORTx bits for driving output. Displays (GLCD, LCD), chip select pins in SPI interfaces and other cases when you need fast and reliable output, **LATx should be used instead of PORTx.**

CHAPTER 8

mikroC PRO for dsPIC30/33 and PIC24 Language Reference

- Lexical Elements

- Whitespace
- Comments
- Tokens
 - Constants
 - Constants Overview
 - Integer Constants
 - Floating Point Constants
 - Character Constants
 - String Constants
 - Enumeration Constants
 - Pointer Constants
 - Constant Expressions
 - Keywords
 - Identifiers
 - Punctuators

- Concepts

- Objects and Lvalues
- Scope and Visibility
- Name Spaces
- Duration

- Types

- Fundamental Types
 - Arithmetic Types
 - Enumerations
 - Void Type
- Derived Types
 - Arrays
 - Pointers
 - Introduction to Pointers
 - Pointer Arithmetic
 - Structures
 - Introduction to Structures
 - Working with Structures
 - Structure Member Access
 - Unions
 - Bit Fields

- Types Conversions
 - Standard Conversions
 - Explicit Typecasting

- Declarations

- Introduction to Declarations
- Linkage
- Storage Classes
- Type Qualifiers
- Typedef Specifier
- ASM Declaration
- Initialization

- Functions

- Introduction to Functions
- Function Calls and Argument Conversion

- Operators

- Introduction to Operators
- Operators Precedence and Associativity
- Arithmetic Operators
- Relational Operators
- Bitwise Operators
- Logical Operators
- Conditional Operator
- Assignment Operators
- Sizeof Operator

- Expressions

- Introduction to Expressions
- Comma Expressions

- Statements

- Introduction
- Labeled Statements
- Expression Statements
- Selection Statements
 - If Statement
 - Switch Statement
- Iteration Statements (Loops)
 - While Statement
 - Do Statement
 - For Statement

- Jump Statements
 - Break and Continue Statements
 - Goto Statement
 - Return Statement
- Compound Statements (Blocks)

- Preprocessor

- Introduction to Preprocessor
- Preprocessor Directives
- Macros
- File Inclusion
- Preprocessor Operators
- Conditional Compilation

Lexical Elements Overview

The following topics provide a formal definition of the mikroC PRO for dsPIC30/33 and PIC24 lexical elements. They describe different categories of word-like units (tokens) recognized by the mikroC PRO for dsPIC30/33 and PIC24.

In the tokenizing phase of compilation, the source code file is parsed (that is, broken down) into tokens and whitespace. The tokens in the mikroC PRO for dsPIC30/33 and PIC24 are derived from a series of operations performed on your programs by the compiler and its built-in preprocessor.

Whitespace

Whitespace is a collective name given to spaces (blanks), horizontal and vertical tabs, newline characters and comments. Whitespace can serve to indicate where tokens start and end, but beyond this function, any surplus whitespace is discarded. For example, two sequences

```
int i; float f;
```

and

```
int
    i;

    float f;
```

are lexically equivalent and parse identically to give six tokens:

```
int
i
;
float
f
;
```

Whitespace in Strings

The ASCII characters representing whitespace can occur within string literals. In that case they are protected from the normal parsing process (they remain as a part of the string). For example,

```
char name[] = "mikro foo";
```

parses into seven tokens, including a single string literal token:

```
char
name
[
]
=
"mikro foo" /* just one token here! */
;
```

Line Splicing with Backslash (\)

A special case occurs if a line ends with a backslash (\). Both backslash and new line character are discarded, allowing two physical lines of a text to be treated as one unit. So, the following code

```
"mikroC PRO for \
dsPIC30/33 and PIC24 Compiler"
```

parses into "mikroC PRO for dsPIC30/33 and PIC24 Compiler". Refer to String Constants for more information.

Comments

Comments are pieces of a text used to annotate a program and technically are another form of whitespace. Comments are for the programmer's use only; they are stripped from the source text before parsing. There are two ways to delineate comments: the C method and the C++ method. Both are supported by mikroC PRO for dsPIC30/33 and PIC24.

You should also follow the guidelines on the use of whitespace and delimiters in comments, discussed later in this topic to avoid other portability problems.

C comments

C comment is any sequence of characters placed after the symbol pair `/*`. The comment terminates at the first occurrence of the pair `*/` following the initial `/*`. The entire sequence, including four comment-delimiter symbols, is replaced by one space after macro expansion.

In the mikroC PRO for dsPIC30/33 and PIC24,

```
int /* type */ i /* identifier */;
```

parses as:

```
int i;
```

Note that the mikroC PRO for dsPIC30/33 and PIC24 does not support a nonportable token pasting strategy using `/**/`. For more information on token pasting, refer to the Preprocessor Operators.

C++ comments

The mikroC PRO for dsPIC30/33 and PIC24 allows single-line comments using two adjacent slashes (`//`). The comment can start in any position and extends until the next new line.

The following code

```
int i; // this is a comment
int j;
```

parses as:

```
int i;
int j;
```

Nested comments

ANSI C doesn't allow nested comments. The attempt to nest a comment like this

```
/* int /* declaration */ i; */
```

fails, because the scope of the first `/*` ends at the first `*/`. This gives us

```
i; */
```

which would generate a syntax error.

Tokens

Token is the smallest element of a C program that compiler can recognize. The parser separates tokens from the input stream by creating the longest token possible using the input characters in a left-to-right scan.

The mikroC PRO for dsPIC30/33 and PIC24 recognizes the following kinds of tokens:

- keywords
- identifiers
- constants
- operators
- punctuators (also known as separators)

Tokens can be concatenated (pasted) by means of the preprocessor operator `##`. See the Preprocessor Operators for details.

Token Extraction Example

Here is an example of token extraction. Take a look at the following example code sequence:

```
inter = a+++b;
```

First, note that `inter` would be parsed as a single identifier, rather than as the keyword `int` followed by the identifier `er`.

The programmer who has written the code might have intended to write `inter = a + (++b)`, but it wouldn't work that way. The compiler would parse it into the seven following tokens:

```
inter    // variable identifier
=        // assignment operator
a        // variable identifier
++       // postincrement operator
+        // addition operator
b        // variable identifier
;        // statement terminator
```

Note that `+++` parses as `++` (the longest token possible) followed by `+`.

According to the operator precedence rules, our code sequence is actually:

```
inter (a++)+b;
```

Constants

Constants or *literals* are tokens representing fixed numeric or character values.

The mikroC PRO for dsPIC30/33 and PIC24 supports:

- integer constants
- floating point constants
- character constants
- string constants (strings literals)
- enumeration constants

The data type of a constant is deduced by the compiler using such clues as a numeric value and format used in the source code.

Integer Constants

Integer constants can be decimal (base 10), hexadecimal (base 16), binary (base 2), or octal (base 8). In the absence of any overriding suffixes, the data type of an integer constant is derived from its value.

Long and Unsigned Suffixes

The suffix `L` (or `l`) attached to any constant forces that constant to be represented as a `long`. Similarly, the suffix `U` (or `u`) forces a constant to be `unsigned`. Both `L` and `U` suffixes can be used with the same constant in any order or case: `uL`, `Lu`, `UL`, etc.

In the absence of any suffix (`U`, `u`, `L`, or `l`), a constant is assigned the “smallest” of the following types that can accommodate its value: `short`, `unsigned short`, `int`, `unsigned int`, `long int`, `unsigned long int`.

Otherwise:

- If a constant has the `U` suffix, its data type will be the first of the following that can accommodate its value: `unsigned short`, `unsigned int`, `unsigned long int`.
- If a constant has the `L` suffix, its data type will be the first of the following that can accommodate its value: `long int`, `unsigned long int`.
- If a constant has both `L` and `U` suffixes, (`LU` or `UL`), its data type will be `unsigned long int`.

Decimal

Decimal constants from -2147483648 to 4294967295 are allowed. Constants exceeding these bounds will produce an “Out of range” error. Decimal constants must not use an initial zero. An integer constant that has an initial zero is interpreted as an octal constant. Thus,

```
int i = 10;    /* decimal 10 */
int i = 010;  /* decimal 8  */
int i = 0;    /* decimal 0 = octal 0 */
```

In the absence of any overriding suffixes, the data type of a decimal constant is derived from its value, as shown below:

Value Assigned to Constant	Assumed Type
< -2147483648	Error: Out of range!
-2147483648 – -32769	long
-32768 – -129	int
-128 – 127	short
128 – 255	unsigned short
256 – 32767	int
32768 – 65535	unsigned int
65536 – 2147483647	long
2147483648 – 4294967295	unsigned long
> 4294967295	Error: Out of range!

Hexadecimal

All constants starting with `0x` (or `0X`) are taken to be hexadecimal. In the absence of any overriding suffixes, the data type of a hexadecimal constant is derived from its value, according to the rules presented above. For example, `0xC367` will be treated as `unsigned int`.

Binary

All constants starting with `0b` (or `0B`) are taken to be binary. In the absence of any overriding suffixes, the data type of a binary constant is derived from its value, according to the rules presented above. For example, `0b11101` will be treated as `short`.

Octal

All constants with an initial zero are taken to be octal. If an octal constant contains the illegal digits 8 or 9, an error is reported. In the absence of any overriding suffixes, the data type of an octal constant is derived from its value, according to the rules presented above. For example, `0777` will be treated as `int`.

Floating Point Constants

A floating-point constant consists of:

- Decimal integer
- Decimal point
- Decimal fraction
- `e` or `E` and a signed integer exponent (optional)
- Type suffix: `f` or `F` or `l` or `L` (optional)

Either decimal integer or decimal fraction (but not both) can be omitted. Either decimal point or letter `e` (or `E`) with a signed integer exponent (but not both) can be omitted. These rules allow conventional and scientific (exponent) notations.

Negative floating constants are taken as positive constants with an unary operator minus (-) prefixed.

The mikroC PRO for dsPIC30/33 and PIC24 limits floating-point constants to the range $\pm 1.17549435082 * 10^{-38}$.. $\pm 6.80564774407 * 10^{38}$.

Here are some examples:

```
0.          // = 0.0
-1.23       // = -1.23
23.45e6     // = 23.45 * 10^6
2e-5        // = 2.0 * 10^-5
3E+10       // = 3.0 * 10^10
.09E34      // = 0.09 * 10^34
```

The mikroC PRO for dsPIC30/33 and PIC24 floating-point constants are of the type `double`. Note that the mikroC PRO for dsPIC's implementation of ANSI Standard considers `float` and `double` (together with the `long double` variant) to be the same type.

Character Constants

A character constant is one or more characters enclosed in single quotes, such as `'A'`, `'+'`, or `'\n'`. In the mikroC PRO for dsPIC30/33 and PIC24, single-character constants are of the `unsigned int` type. Multi-character constants are referred to as *string constants* or *string literals*. For more information refer to String Constants.

Escape Sequences

A backslash character (`\`) is used to introduce an escape sequence, which allows a visual representation of certain nongraphic characters. One of the most common escape constants is the newline character (`\n`).

A backslash is used with octal or hexadecimal numbers to represent an ASCII symbol or control code corresponding to that value; for example, `'\x3F'` for the question mark. Any value within legal range for data type `char` (0 to `0xFF` for the mikroC PRO for dsPIC30/33 and PIC24) can be used. Larger numbers will generate the compiler error "Out of range".

For example, the octal number `\777` is larger than the maximum value allowed (`\377`) and will generate an error. The first nonoctal or nonhexadecimal character encountered in an octal or hexadecimal escape sequence marks the end of the sequence.

Note: You must use the sequence `\\` to represent an ASCII backslash, as used in operating system paths.

The following table shows the available escape sequences:

Sequence	Value	Char	What it does?
<code>\a</code>	0x07	BEL	Audible bell
<code>\b</code>	0x08	BS	Backspace
<code>\f</code>	0x0C	FF	Formfeed
<code>\n</code>	0x0A	LF	Newline (Linefeed)
<code>\r</code>	0x0D	CR	Carriage Return
<code>\t</code>	0x09	HT	Tab (horizontal)
<code>\v</code>	0x0B	VT	Vertical Tab
<code>\\</code>	0x5C	\	Backslash
<code>\'</code>	0x27	'	Single quote (Apostrophe)
<code>\"</code>	0x22	"	Double quote
<code>\?</code>	0x3F	?	Question mark
<code>\O</code>		any	O = string of up to 3 octal digits
<code>\xH</code>		any	H = string of hex digits
<code>\XH</code>		any	H = string of hex digits

Disambiguation

Some ambiguous situations might arise when using escape sequences.

Here is an example:

```
Lcd_Out_Cp("\x091.0 Intro");
```

This is intended to be interpreted as `\x09` and `"1.0 Intro"`. However, the mikroC PRO for dsPIC30/33 and PIC24 compiles it as the hexadecimal number `\x091` and literal string `".0 Intro"`. To avoid such problems, we could rewrite the code in the following way:

```
Lcd_Out_Cp("\x09" "1.0 Intro");
```

For more information on the previous line, refer to String Constants.

Ambiguities might also arise if an octal escape sequence is followed by a nonoctal digit. For example, the following constant:

```
"\118"
```

would be interpreted as a two-character constant made up of the characters `\11` and `8`, because `8` is not a legal octal digit.

String Constants

String constants, also known as *string literals*, are a special type of constants which store fixed sequences of characters. A string literal is a sequence of any number of characters surrounded by double quotes:

```
"This is a string."
```

The *null string*, or empty string, is written like `""`. A literal string is stored internally as a given sequence of characters plus a final null character. A null string is stored as a single null character.

The characters inside the double quotes can include escape sequences. This code, for example:

```
"\t\"Name\"\\\"Address\n\n"
```

prints like this:

```
    "Name" \      Address
```

The "Name" is preceded by two tabs; The Address is preceded by one tab. The line is followed by two new lines. The `\` provides interior double quotes. The escape character sequence `\\` is translated into `\` by the compiler.

Adjacent string literals separated only by whitespace are concatenated during the parsing phase. For example:

```
"This is " "just"  
  " an example."
```

is equivalent to

```
"This is just an example."
```

Line Continuation with Backslash

You can also use the backslash (`\`) as a continuation character to extend a string constant across line boundaries:

```
"This is really \  
  a one-line string."
```

Enumeration Constants

Enumeration constants are identifiers defined in `enum` type declarations. The identifiers are usually chosen as mnemonics to contribute to legibility. Enumeration size is calculated according to the enumerators (enumeration elements). They can be used in any expression where integer constants are valid.

For example:

```
enum weekdays { SUN = 0, MON, TUE, WED, THU, FRI, SAT };
```

The identifiers (enumerators) used must be unique within the scope of the `enum` declaration. Negative initializers are allowed. See Enumerations for details about `enum` declarations.

Pointer Constants

A pointer or pointed-at object can be declared with the `const` modifier. Anything declared as `const` cannot change its value. It is also illegal to create a pointer that might violate a non-assignability of the constant object.

Consider the following examples:

```
int i;                // i is an int
int * pi;             // pi is a pointer to int (uninitialized)
int * const cp = &i;  // cp is a constant pointer to int
const int ci = 7;     // ci is a constant int
const int * pci;      // pci is a pointer to constant int
const int * const cpc = &ci; // cpc is a constant pointer to a constant int
```

The following assignments are legal:

```
i = ci;                // Assign const-int to int
*cp = ci;              // Assign const-int to
                      // object-pointed-at-by-a-const-pointer
++pci;                // Increment a pointer-to-const
pci = cpc;             // Assign a const-pointer-to-a-const to a pointer-to-const
```

The following assignments are illegal:

```
ci = 0;                // NO--cannot assign to a const-int
ci--;                 // NO--cannot change a const-int
*pci = 3;             // NO--cannot assign to an object
                      // pointed at by pointer-to-const.
cp = &ci;             // NO--cannot assign to a const-pointer,
                      // even if value would be unchanged.
cpc++;                // NO--cannot change const-pointer
pi = pci;             // NO--if this assignment were allowed,
                      // you would be able to assign to *pci
                      // (a const value) by assigning to *pi.
```

Similar rules are applied to the `volatile` modifier. Note that both `const` and `volatile` can appear as modifiers to the same identifier.

Notes:

- Pointer to constant space (Flash memory) is allocated in RAM.
- Due to the previous note, it is not possible to define an `extern const`.
- Constants of a simple type are not allocated in the Flash memory nor in RAM, but changed in the compile time, and therefore, address of a such constant can not be obtained.

Constant Expressions

A constant expressions can be evaluated during translation rather than runtime and accordingly may be used in any place that a constant may be.

Constant expressions can consist only of the following:

- literals,
- enumeration constants,
- simple constants (no constant arrays or structures),
- `sizeof` operators.

Constant expressions cannot contain any of the following operators, unless the operators are contained within the operand of a `sizeof` operator: assignment, comma, decrement, function call, increment.

Each constant expression can evaluate to a constant that is in the range of representable values for its type.

Constant expression can be used anywhere a constant is legal.

Keywords

Keywords are words reserved for special purposes and must not be used as normal identifier names.

Beside standard C keywords, all relevant SFR are defined as global variables and represent reserved words that cannot be redefined (for example: TMR0, PCL, etc). Probe the Code Assistant for specific letters (Ctrl+Space in Editor) or refer to Predefined Globals and Constants.

Here is an alphabetical listing of keywords in C:

- absolute
- asm
- at
- auto
- bit
- bool
- break
- case
- catch
- char
- class
- code
- const
- continue
- data
- default
- delete
- dma
- do
- double
- else
- enum
- explicit
- extern
- false
- far
- float
- for
- friend
- goto
- if
- inline
- int
- iv
- long
- mutable
- namespace
- near
- operator
- org
- pascal
- private

- protected
- public
- register
- return
- rx
- sfr
- short
- signed
- sizeof
- static
- struct
- switch
- template
- this
- throw
- true
- try
- typedef
- typeid
- typename
- union
- unsigned
- using
- virtual
- void
- volatile
- while
- xdata
- ydata

Also, the mikroC PRO for dsPIC30/33 and PIC24 includes a number of predefined identifiers used in libraries. You could replace them by your own definitions, if you want to develop your own libraries. For more information, see mikroC PRO for dsPIC30/33 and PIC24 Libraries.

Identifiers

Identifiers are arbitrary names of any length given to functions, variables, symbolic constants, user-defined data types and labels. All these program elements will be referred to as *objects* throughout the help (don't get confused with the meaning of *object* in object-oriented programming).

Identifiers can contain the letters a to z and A to Z, underscore character “_”, and digits from 0 to 9. The only restriction is that the first character must be a letter or an underscore.

Case Sensitivity

The mikroC PRO for dsPIC30/33 and PIC24 identifiers aren't case sensitive by default, so that Sum, sum, and suM represent an equivalent identifier. Case sensitivity can be activated or suspended in Output Settings window. Even if case sensitivity is turned off Keywords remain case sensitive and they must be written in lower case.

Uniqueness and Scope

Although identifier names are arbitrary (according to the stated rules), if the same name is used for more than one identifier within the same scope and sharing the same name space then error arises. Duplicate names are legal for different name spaces regardless of scope rules. For more information on scope, refer to Scope and Visibility.

Identifier Examples

Here are some valid identifiers:

```
temperature_V1
Pressure
no_hit
dat2string
SUM3
_vtext
```

... and here are some invalid identifiers:

```
7temp          // NO -- cannot begin with a numeral
%higher        // NO -- cannot contain special characters
int            // NO -- cannot match reserved word
j23.07.04      // NO -- cannot contain special characters (dot)
```

Punctuators

The mikroC PRO for dsPIC30/33 and PIC24 punctuators (also known as separators) are:

- [] – Brackets
- () – Parentheses
- { } – Braces
- , – Comma
- ; – Semicolon
- : – Colon
- * – Asterisk
- = – Equal sign
- # – Pound sign

Most of these punctuators also function as operators.

Brackets

Brackets [] indicate single and multidimensional array subscripts:

```
char ch, str[] = "mikro";

int mat[3][4];          /* 3 x 4 matrix */
ch = str[3];           /* 4th element */
```

Parentheses

Parentheses () are used to group expressions, isolate conditional expressions, and indicate function calls and function parameters:

```
d = c * (a + b);      /* override normal precedence */

if (d == z) ++x;     /* essential with conditional statement */
func();              /* function call, no args */
void func2(int n);   /* function declaration with parameters */
```

Parentheses are recommended in macro definitions to avoid potential precedence problems during an expansion:

```
#define CUBE(x) ((x) * (x) * (x))
```

For more information, refer to Operators Precedence And Associativity and Expressions.

Braces

Braces { } indicate the start and end of a compound statement:

```
if (d == z) {
    ++x;
    func();
}
```

Closing brace serves as a terminator for the compound statement, so a semicolon is not required after }, except in structure declarations. Sometimes, the semicolon can be illegal, as in

```
if (statement)
    { ... }; /* illegal semicolon! */
else
    { ... };
```

For more information, refer to the Compound Statements.

Comma

Comma (,) separates the elements of a function argument list:

```
void func(int n, float f, char ch);
```

Comma is also used as an operator in comma expressions. Mixing two uses of comma is legal, but you must use parentheses to distinguish them. Note that (exp1, exp2) evaluates both but is equal to the second:

```
func(i, j); /* call func with two args */
func((exp1, exp2), (exp3, exp4, exp5)); /* also calls func with two args! */
```

Semicolon

Semicolon (;) is a statement terminator. Any legal C expression (including the empty expression) followed by a semicolon is interpreted as a statement, known as an expression statement. The expression is evaluated and its value is discarded. If the expression statement has no side effects, the mikroC PRO for dsPIC30/33 and PIC24 might ignore it.

```
a + b;    /* Evaluate a + b, but discard value */
++a;     /* Side effect on a, but discard value of ++a */
;        /* Empty expression, or a null statement */
```

Semicolons are sometimes used to create an *empty* statement:

```
for (i = 0; i < n; i++);
```

For more information, see the Statements.

Colon

Use colon (:) to indicate the labeled statement:

```
start:  x = 0;
        ...
goto start;
```

Labels are discussed in the Labeled Statements.

Asterisk (Pointer Declaration)

Asterisk (*) in a variable declaration denotes the creation of a pointer to a type:

```
char *char_ptr; /* a pointer to char is declared */
```

Pointers with multiple levels of indirection can be declared by indicating a pertinent number of asterisks:

```
int **int_ptr;      /* a pointer to an array of integers */
double ***double_ptr; /* a pointer to a matrix of doubles */
```

You can also use asterisk as an operator to either dereference a pointer or as multiplication operator:

```
i = *int_ptr;
a = b * 3.14;
```

For more information, see the Pointers.

Equal Sign

Equal sign (=) separates variable declarations from initialization lists:

```
int test[5] = { 1, 2, 3, 4, 5 };  
int x = 5;
```

Equal sign is also used as an assignment operator in expressions:

```
int a, b, c;  
a = b + c;
```

For more information, see Assignment Operators.

Pound Sign (Preprocessor Directive)

Pound sign (#) indicates a preprocessor directive when it occurs as the first nonwhitespace character on a line. It signifies a compiler action, not necessarily associated with a code generation. See the Preprocessor Directives for more information.

and ## are also used as operators to perform token replacement and merging during the preprocessor scanning phase. See the Preprocessor Operators.

Concepts

This section covers some basic concepts of language, essential for understanding of how C programs work. First, we need to establish the following terms that will be used throughout the help:

- Objects and lvalues
- Scope and Visibility
- Name Spaces
- Duration

Objects

An object is a specific region of memory that can hold a fixed or variable value (or set of values). This use of a term *object* is different from the same term, used in object-oriented languages, which is more general. Our definition of the word would encompass functions, variables, symbolic constants, user-defined data types, and labels.

Each value has an associated name and type (also known as a data type). The name is used to access the object and can be a simple identifier or complex expression that uniquely refers the object.

Objects and Declarations

Declarations establish a necessary mapping between identifiers and objects. Each declaration associates an identifier with a data type.

Associating identifiers with objects requires each identifier to have at least two attributes: storage class and type (sometimes referred to as data type). The mikroC PRO for dsPIC30/33 and PIC24 compiler deduces these attributes from implicit or explicit declarations in the source code. Usually, only the type is explicitly specified and the storage class specifier assumes the automatic value `auto`.

Generally speaking, an identifier cannot be legally used in a program before its declaration point in the source code. Legal exceptions to this rule (known as forward references) are labels, calls to undeclared functions, and struct or union tags.

The range of objects that can be declared includes:

- Variables
- Functions
- Types
- Arrays of other types
- Structure, union, and enumeration tags
- Structure members
- Union members
- Enumeration constants
- Statement labels
- Preprocessor macros

The recursive nature of the declarator syntax allows complex declarators. You'll probably want to use typedefs to improve legibility if constructing complex objects.

Lvalues

Lvalue is an object locator: an expression that designates an object. An example of lvalue expression is `*P`, where `P` is any expression evaluating to a non-null pointer. A modifiable lvalue is an identifier or expression that relates to an object that can be accessed and legally changed in memory. A const pointer to a constant, for example, is not a modifiable lvalue. A pointer to a constant can be changed (but its dereferenced value cannot).

Historically, `l` stood for “left”, meaning that lvalue could legally stand on the left (the receiving end) of an assignment statement. Now only modifiable lvalues can legally stand to the left of an assignment operator. For example, if `a` and `b` are nonconstant integer identifiers with properly allocated memory storage, they are both modifiable lvalues, and assignments such as `a = 1` and `b = a + b` are legal.

Rvalues

The expression `a + b` is not lvalue: `a + b = a` is illegal because the expression on the left is not related to an object. Such expressions are sometimes called *rvalues* (short for right values).

Scope and Visibility

Scope

The scope of an identifier is a part of the program in which the identifier can be used to access its object. There are different categories of scope: block (or local), function, function prototype, and file. These categories depend on how and where identifiers are declared.

- **Block:** The scope of an identifier with block (or local) scope starts at the declaration point and ends at the end of the block containing the declaration (such block is known as the enclosing block). Parameter declarations with a function definition also have block scope, limited to the scope of the function body.
- **File:** File scope identifiers, also known as *globals*, are declared outside of all blocks; their scope is from the point of declaration to the end of the source file.
- **Function:** The only identifiers having function scope are statement labels. Label names can be used with goto statements anywhere in the function in which the label is declared. Labels are declared implicitly by writing `label_name:` followed by a statement. Label names must be unique within a function.
- **Function prototype:** Identifiers declared within the list of parameter declarations in a function prototype (not as a part of a function definition) have a function prototype scope. This scope ends at the end of the function prototype.

Visibility

The visibility of an identifier is a region of the program source code from which an identifier’s associated object can be legally accessed.

Scope and visibility usually coincide, though there are circumstances under which an object becomes temporarily hidden by the appearance of a duplicate identifier: the object still exists but the original identifier cannot be used to access it until the scope of the duplicate identifier ends.

Technically, visibility cannot exceed a scope, but a scope *can* exceed visibility. See the following example:

```
void f (int i) {
    int j;          // auto by default
    j = 3;         // int i and j are in scope and visible

    {             // nested block
        double j;  // j is local name in the nested block
        j = 0.1;   // i and double j are visible;
                  // int j = 3 in scope but hidden
    }

    // double j out of scope
    j += 1;       // int j visible and = 4
}
// i and j are both out of scope
```

Name Spaces

Name space is a scope within which an identifier must be unique. The mikroC PRO for dsPIC30/33 and PIC24 uses four distinct categories of identifiers:

1. `goto` label names - must be unique within the function in which they are declared.
2. Structure, union, and enumeration tags - must be unique within the block in which they are defined. Tags declared outside of any function must be unique.
3. Structure and union member names - must be unique within the structure or union in which they are defined. There is no restriction on the type or offset of members with the same member name in different structures.
4. Variables, typedefs, functions, and enumeration members - must be unique within the scope in which they are defined. Externally declared identifiers must be unique among externally declared variables.

Duplicate names are legal for different name spaces regardless of the scope rules.

For example:

```
int blue = 73;

{ // open a block
    enum colors { black, red, green, blue, violet, white } c;
    /* enumerator blue = 3 now hides outer declaration of int blue */

    struct colors { int i, j; }; // ILLEGAL: colors duplicate tag
    double red = 2;           // ILLEGAL: redefinition of red
}

blue = 37; // back in int blue scope
```

Duration

Duration, closely related to a storage class, defines a period during which the declared identifiers have real, physical objects allocated in memory. We also distinguish between compile-time and run-time objects. Variables, for instance, unlike typedefs and types, have real memory allocated during run time. There are two kinds of duration: *static* and *local*.

Static Duration

Memory is allocated to objects with static duration as soon as execution is underway; this storage allocation lasts until the program terminates. Static duration objects usually reside in fixed data segments allocated according to the memory specifier in force. All globals have static duration. All functions, wherever defined, are objects with static duration. Other variables can be given static duration by using the explicit `static` or `extern` storage class specifiers.

In the mikroC PRO for dsPIC30/33 and PIC24, static duration objects are *not* initialized to zero (or null) in the absence of any explicit initializer.

Don't mix static duration with file or global scope. An object can have static duration *and* local scope – see the example below.

Local Duration

Local duration objects are also known as *automatic* objects. They are created on the stack (or in a register) when an enclosing block or a function is entered. They are deallocated when the program exits that block or function. Local duration objects must be explicitly initialized; otherwise, their contents are unpredictable.

The storage class specifier `auto` can be used when declaring local duration variables, but it is usually redundant, because `auto` is default for variables declared within a block.

An object with local duration also has local scope because it does not exist outside of its enclosing block. On the other hand, a local scope object *can* have static duration. For example:

```
void f() {
    /* local duration variable; init a upon every call to f */
    int a = 1;
    /* static duration variable; init b only upon first call to f */
    static int b = 1;
    /* checkpoint! */
    a++;
    b++;
}

void main() {
    /* At checkpoint, we will have: */
    f(); // a=1, b=1, after first call,
    f(); // a=1, b=2, after second call,
    f(); // a=1, b=3, after third call,
        // etc.
}
```

Types

The mikroC PRO for dsPIC30/33 and PIC24 is a strictly typed language, which means that every object, function, and expression must have a strictly defined type, known in the time of compilation. Note that the mikroC PRO for dsPIC30/33 and PIC24 works exclusively with numeric types.

The type serves:

- to determine the correct memory allocation required,
- to interpret the bit patterns found in the object during subsequent accesses,
- in many type-checking situations, to ensure that illegal assignments are trapped.

The mikroC PRO for dsPIC30/33 and PIC24 supports many standard (predefined) and user-defined data types, including signed and unsigned integers in various sizes, floating-point numbers with various precisions, arrays, structures, and unions. In addition, pointers to most of these objects can be established and manipulated in memory.

The type determines how much memory is allocated to an object and how the program will interpret the bit patterns found in the object's storage allocation. A given data type can be viewed as a set of values (often implementation-dependent) that identifiers of that type can assume, together with a set of operations allowed with these values. The compile-time operator `sizeof` allows you to determine the size in bytes of any standard or user-defined type.

The mikroC PRO for dsPIC30/33 and PIC24 standard libraries and your own program and header files must provide unambiguous identifiers (or expressions derived from them) and types so that the mikroC PRO for dsPIC can consistently access, interpret, and (possibly) change the bit patterns in memory corresponding to each active object in your program.

Type Categories

A common way to categorize types is to divide them into:

- fundamental
- derived

The fundamental types represent types that cannot be split up into smaller parts. They are sometimes referred to as *unstructured* types. The fundamental types are `void`, `char`, `int`, `float`, and `double`, together with `short`, `long`, `signed`, and `unsigned` variants of some of them. For more information on fundamental types, refer to the topic Fundamental Types.

The derived types are also known as *structured* types and they include pointers to other types, arrays of other types, function types, structures, and unions. For more information on derived types, refer to the topic Derived Types.

Fundamental Types

The fundamental types represent types that cannot be divided into more basic elements, and are the model for representing elementary data on machine level. The fundamental types are sometimes referred to as *unstructured types*, and are used as elements in creating more complex derived or user-defined types.

The fundamental types include:

- Arithmetic Types
- Enumerations
- Void Type

Arithmetic Types

The arithmetic type specifiers are built up from the following keywords: `void`, `char`, `int`, `float` and `double`, together with the prefixes `short`, `long`, `signed` and `unsigned`. From these keywords you can build both integral and floating-point types.

Integral Types

The types `char` and `int`, together with their variants, are considered to be integral data types. Variants are created by using one of the prefix modifiers `short`, `long`, `signed` and `unsigned`.

In the table below is an overview of the integral types – keywords in parentheses can be (and often are) omitted.

The modifiers `signed` and `unsigned` can be applied to both `char` and `int`. In the absence of the `unsigned` prefix, `signed` is automatically assumed for integral types. The only exception is `char`, which is `unsigned` by default. The keywords `signed` and `unsigned`, when used on their own, mean `signed int` and `unsigned int`, respectively.

The modifiers `short` and `long` can only be applied to `int`. The keywords `short` and `long`, used on their own, mean `short int` and `long int`, respectively.

Type	Size in bytes	Range
<code>bit</code>	1-bit	0 or 1
<code>sbit</code>	1-bit	0 or 1
<code>(unsigned) char</code>	1	0 .. 255
<code>signed char</code>	1	- 128 .. 127
<code>(signed) short (int)</code>	1	- 128 .. 127
<code>unsigned short (int)</code>	1	0 .. 255
<code>(signed) int</code>	2	-32768 .. 32767
<code>unsigned (int)</code>	2	0 .. 65535
<code>(signed) long (int)</code>	4	-2147483648 .. 2147483647
<code>unsigned long (int)</code>	4	0 .. 4294967295

Floating-point Types

The types `float` and `double`, together with the `long double` variant, are considered to be floating-point types. The mikroC PRO for dsPIC30/33 and PIC24's implementation of an ANSI Standard considers all three to be the same type.

Floating point in the mikroC PRO for dsPIC30/33 and PIC24 is implemented using the Microchip AN575 32-bit format (IEEE 754 compliant).

An overview of the floating-point types is shown in the table below:

Type	Size in bytes	Range
<code>float</code>	4	$-1.5 * 10^{45} .. +3.4 * 10^{38}$
<code>double</code>	4	$-1.5 * 10^{45} .. +3.4 * 10^{38}$
<code>long double</code>	4	$-1.5 * 10^{45} .. +3.4 * 10^{38}$

Enumerations

An enumeration data type is used for representing an abstract, discreet set of values with appropriate symbolic names.

Enumeration Declaration

Enumeration is declared like this:

```
enum tag {enumeration-list};
```

Here, `tag` is an optional name of the enumeration; `enumeration-list` is a comma-delimited list of discreet values, `enumerators` (or enumeration constants). Each enumerator is assigned a fixed integral value. In the absence of explicit initializers, the first enumerator is set to zero, and the value of each succeeding enumerator is set to a value of its predecessor increased by one.

Variables of the `enum` type are declared the same as variables of any other type. For example, the following declaration:

```
enum colors { black, red, green, blue, violet, white } c;
```

establishes a unique integral type, `enum colors`, variable `c` of this type, and set of enumerators with constant integer values (`black = 0`, `red = 1`, ...). In the mikroC PRO for dsPIC30/33 and PIC24, a variable of an enumerated type can be assigned any value of the type `int` – no type checking beyond that is enforced. That is:

```
c = red;           // OK  
c = 1;            // Also OK, means the same
```

With explicit integral initializers, you can set one or more enumerators to specific values. The initializer can be any expression yielding a positive or negative integer value (after possible integer promotions). Any subsequent names without initializers will be increased by one. These values are usually unique, but duplicates are legal.

The order of constants can be explicitly re-arranged. For example:

```
enum colors { black,      // value 0
             red,        // value 1
             green,     // value 2
             blue=6,    // value 6
             violet,    // value 7
             white=4 }; // value 4
```

Initializer expression can include previously declared enumerators. For example, in the following declaration:

```
enum memory_sizes { bit = 1, nibble = 4 * bit, byte = 2 * nibble,
                  kilobyte = 1024 * byte };
```

nibble would acquire the value 4, byte the value 8, and kilobyte the value 8192.

Anonymous Enum Type

In our previous declaration, the identifier `colors` is an optional enumeration tag that can be used in subsequent declarations of enumeration variables of the `enum colors` type:

```
enum colors bg, border; /* declare variables bg and border */
```

Like with struct and union declarations, you can omit the tag if no further variables of this `enum` type are required:

```
/* Anonymous enum type: */
enum { black, red, green, blue, violet, white } color;
```

Enumeration Scope

Enumeration tags share the same name space as structure and union tags. Enumerators share the same name space as ordinary variable identifiers:

```
int blue = 73;

{ // open a block
  enum colors { black, red, green, blue, violet, white } c;
  /* enumerator blue = 3 now hides outer declaration of int blue */

  struct colors { int i, j; }; // ILLEGAL: colors duplicate tag
  double red = 2;           // ILLEGAL: redefinition of red
}

blue = 37;                  // back in int blue scope
```

Void Type

`void` is a special type indicating the absence of any value. There are no objects of `void`; instead, `void` is used for deriving more complex types.

Void Functions

Use the `void` keyword as a function return type if the function does not return a value.

```
void print_temp(char temp) {
    Lcd_Out_Cp("Temperature:");
    Lcd_Out_Cp(temp);
    Lcd_Chr_Cp(223); // degree character
    Lcd_Chr_Cp('C');
}
```

Use `void` as a function heading if the function does not take any parameters. Alternatively, you can just write empty parentheses:

```
main(void) { // same as main()
    ...
}
```

Generic Pointers

Pointers can be declared as `void`, which means that they can point to any type. These pointers are sometimes called *generic*.

Derived Types

The derived types are also known as *structured types*. They are used as elements in creating more complex user-defined types.

The derived types include:

- arrays
- pointers
- structures
- unions

Arrays

Array is the simplest and most commonly used structured type. A variable of array type is actually an array of objects of the same type. These objects represent elements of an array and are identified by their position in array. An array consists of a contiguous region of storage exactly large enough to hold all of its elements.

Array Declaration

Array declaration is similar to variable declaration, with the brackets added after identifier:

```
type array_name[constant-expression]
```

This declares an array named as `array_name` and composed of elements of `type`. The `type` can be any scalar type (except `void`), user-defined type, pointer, enumeration, or another array. Result of `constant-expression` within the brackets determines a number of elements in array. If an expression is given in an array declarator, it must evaluate to a positive constant integer. The value is a number of elements in an array.

Each of the elements of an array is indexed from 0 to the number of elements minus one. If a number of elements is `n`, elements of array can be approached as variables `array_name[0] .. array_name[n-1]` of `type`.

Here are a few examples of array declaration:

```
#define MAX = 50
int    vector_one[10];           /* declares an array of 10 integers */
float  vector_two[MAX];         /* declares an array of 50 floats   */
float  vector_three[MAX - 20];  /* declares an array of 30 floats   */
```

Array Initialization

An array can be initialized in declaration by assigning it a comma-delimited sequence of values within braces. When initializing an array in declaration, you can omit the number of elements – it will be automatically determined according to the number of elements assigned. For example:

```
/* Declare an array which holds number of days in each month: */
int days[12] = {31,28,31,30,31,30,31,31,30,31,30,31};

/* This declaration is identical to the previous one */
int days[] = {31,28,31,30,31,30,31,31,30,31,30,31};
```

If you specify both the length and starting values, the number of starting values must not exceed the specified length. The opposite is possible, in this case the trailing “excess” elements will be assigned to some encountered runtime values from memory.

In case of array of `char`, you can use a shorter *string literal* notation. For example:

```
/* The two declarations are identical: */
const char msg1[] = {'T', 'e', 's', 't', '\\0'};
const char msg2[] = "Test";
```

For more information on string literals, refer to String Constants.

Arrays in Expressions

When the name of an array comes up in expression evaluation (except with operators `&` and `sizeof`), it is implicitly converted to the pointer pointing to array's first element. See Arrays and Pointers for more information.

Multi-dimensional Arrays

An array is one-dimensional if it is of scalar type. One-dimensional arrays are sometimes referred to as *vectors*.

Multidimensional arrays are constructed by declaring arrays of array type. These arrays are stored in memory in such way that the right most subscript changes fastest, i.e. arrays are stored "in rows". Here is a sample of 2-dimensional array:

```
float m[50][20]; /* 2-dimensional array of size 50x20 */
```

A variable `m` is an array of 50 elements, which in turn are arrays of 20 floats each. Thus, we have a matrix of 50x20 elements: the first element is `m[0][0]`, the last one is `m[49][19]`. The first element of the 5th row would be `m[4][0]`.

If you don't initialize the array in the declaration, you can omit the first dimension of multi-dimensional array. In that case, array is located elsewhere, e.g. in another file. This is a commonly used technique when passing arrays as function parameters:

```
int a[3][2][4]; /* 3-dimensional array of size 3x2x4 */

void func(int n[][2][4]) { /* we can omit first dimension */
    ...
    n[2][1][3]++; /* increment the last element*/
}

void main() {
    ...
    func(a);
}
```

You can initialize a multi-dimensional array with an appropriate set of values within braces. For example:

```
int a[3][2] = {{1,2}, {2,6}, {3,7}};
```

Pointers

Pointers are special objects for holding (or “pointing to”) memory addresses. In the mikroC PRO for dsPIC30/33 and PIC24, address of an object in memory can be obtained by means of an unary operator `&`. To reach the pointed object, we use an indirection operator (`*`) on a pointer.

A pointer of type “pointer to object of type” holds the address of (that is, points to) an object of `type`. Since pointers are objects, you can have a pointer pointing to a pointer (and so on). Other objects commonly pointed to include arrays, structures, and unions.

A pointer to a function is best thought of as an address, usually in a code segment, where that function’s executable code is stored; that is, the address to which control is transferred when that function is called.

Although pointers contain numbers with most of the characteristics of unsigned integers, they have their own rules and restrictions for declarations, assignments, conversions, and arithmetic. The examples in the next few sections illustrate these rules and restrictions.

Pointer Declarations

Pointers are declared the same as any other variable, but with `*` ahead of identifier. A type at the beginning of declaration specifies the type of a pointed object. A pointer must be declared as pointing to some particular type, even if that type is `void`, which really means a pointer to anything. Pointers to `void` are often called *generic pointers*, and are treated as pointers to `char` in the mikroC PRO for dsPIC30/33 and PIC24.

If `type` is any predefined or user-defined type, including `void`, the declaration

```
type *p;    /* Uninitialized pointer */
```

declares `p` to be of type “pointer to `type`”. All scoping, duration, and visibility rules are applied to the `p` object just declared. You can view the declaration in this way: if `*p` is an object of `type`, then `p` has to be a pointer to such object (object of `type`).

Note: You must initialize pointers before using them! Our previously declared pointer `*p` is not initialized (i.e. assigned a value), so it cannot be used yet.

In case of multiple pointer declarations, each identifier requires an indirect operator. For example:

```
int *pa, *pb, *pc;

// is same as :

int *pa;
int *pb;
int *pc;
```

Once declared, though, a pointer can usually be reassigned so that it points to an object of another type. The mikroC PRO for dsPIC30/33 and PIC24 lets you reassign pointers without typecasting, but the compiler will warn you unless the pointer was originally declared to be pointing to `void`. You can assign the `void*` pointer to the non-`void*` pointer – refer to `void` for details.

Null Pointers

A *null pointer* value is an address that is guaranteed to be different from any valid pointer in use in a program. Assigning the integer constant 0 to a pointer assigns a null pointer value to it.

For example:

```
int *pn = 0;          /* Here's one null pointer */

/* We can test the pointer like this: */
if ( pn == 0 ) { ... }
```

The pointer type “pointer to void” must not be confused with the null pointer. The declaration

```
void *vp;
```

declares that `vp` is a generic pointer capable of being assigned to by any “pointer to type” value, including null, without complaint.

Assignments without proper casting between a “pointer to `type1`” and a “pointer to `type2`”, where `type1` and `type2` are different types, can invoke a compiler warning or error. If `type1` is a function and `type2` isn't (or vice versa), pointer assignments are illegal. If `type1` is a pointer to `void`, no cast is needed. If `type2` is a pointer to `void`, no cast is needed.

Assign an address to a Function Pointer

It's quite easy to assign the address of a function to a function pointer. Simply take the name of a suitable and known function. Using the address operator `&` in front of the function's name is optional.

```
//Assign an address to the function pointer

int DoIt (float a, char b, char c){ return a+b+c; }
pt2Function = &DoIt; // assignment
```

Example:

```
int addC(char x,char y){
    return x+y;
}

int subC(char x,char y){
    return x-y;
}

int mulC(char x,char y){
    return x*y;
}

int divC(char x,char y){
    return x/y;
}

int modC(char x,char y){
    return x%y;
}

//array of pointer to functions that receive two chars and returns int
int (*arrpf[])(char,char) = { addC ,subC,mulC,divC,modC};

int res;
char i;
void main() {
    for (i=0;i<5;i++){
        res = arrpf[i](10,20);
    }
}
```

Function Pointers

Function Pointers are pointers, i.e. variables, which point to the address of a function.

```
// Define a function pointer
int (*pt2Function) (float, char, char);
```

Note: Thus functions and function pointers with different calling convention (argument order, arguments type or return type is different) are incompatible with each other.

Assign an address to a Function Pointer

It's quite easy to assign the address of a function to a function pointer. Simply take the name of a suitable and known function. Using the address operator & in front of the function's name is optional.

```
//Assign an address to the function pointer

int DoIt (float a, char b, char c){ return a+b+c; }
pt2Function = &DoIt; // assignment
```

Example:

```
int addC(char x,char y){
    return x+y;
}

int subC(char x,char y){
    return x-y;
}

int mulC(char x,char y){
    return x*y;
}

int divC(char x,char y){
    return x/y;
}

int modC(char x,char y){
    return x%y;
}
```

```

//array of pointer to functions that receive two chars and returns int
int (*arrpf[])(char,char) = { addC ,subC,mulC,divC,modC};

int res;
char i;
void main() {

    for (i=0;i<5;i++){
        res = arrpf[i](10,20);
    }

}

```

Pointer Arithmetic

Pointer arithmetic in the mikroC PRO for dsPIC30/33 and PIC24 is limited to:

- assigning one pointer to another,
- comparing two pointers,
- comparing pointer to zero,
- adding/subtracting pointer and an integer value,
- subtracting two pointers.

The internal arithmetic performed on pointers depends on the memory specifier in force and the presence of any overriding pointer modifiers. When performing arithmetic with pointers, it is assumed that the pointer points to an array of objects.

Arrays and Pointers

Arrays and pointers are not completely independent types in the mikroC PRO for dsPIC30/33 and PIC24. When the name of an array comes up in expression evaluation (except with operators `&` and `sizeof`), it is implicitly converted to the pointer pointing to array's first element. Due to this fact, arrays are not modifiable lvalues.

Brackets `[]` indicate array subscripts. The expression

```
id[exp]
```

is defined as

```
*((id) + (exp))
```

where either:

- `id` is a pointer and `exp` is an integer, or
- `id` is an integer and `exp` is a pointer.

The following statements are true:

```
&a[i] = a + i
a[i] = *(a + i)
```

According to these guidelines, it can be written:

```
pa = &a[4];          // pa points to a[4]
x = *(pa + 3);      // x = a[7]

/* .. but: */
y = *pa + 3;        // y = a[4] + 3
```

Also the care should be taken when using operator precedence:

```
*pa++;              // Equal to *(pa++), increments the pointer
(*pa)++;            // Increments the pointed object!
```

The following examples are also valid, but better avoid this syntax as it can make the code really illegible:

```
(a + 1)[i] = 3;
// same as: *((a + 1) + i) = 3, i.e. a[i + 1] = 3

(i + 2)[a] = 0;
// same as: *((i + 2) + a) = 0, i.e. a[i + 2] = 0
```

Assignment and Comparison

The simple assignment operator (=) can be used to assign value of one pointer to another if they are of the same type. If they are of different types, you must use a typecast operator. Explicit type conversion is not necessary if one of the pointers is generic (of the `void` type).

Assigning the integer constant 0 to a pointer assigns a null pointer value to it.

Two pointers pointing to the same array may be compared by using relational operators ==, !=, <, <=, >, and >=. Results of these operations are the same as if they were used on subscript values of array elements in question:

```
int *pa = &a[4], *pb = &a[2];

if (pa == pb) {... /* won't be executed as 4 is not equal to 2 */ }
if (pa > pb) {... /* will be executed as 4 is greater than 2 */ }
```

You can also compare pointers to zero value – testing in that way if the pointer actually points to anything. All pointers can be successfully tested for equality or inequality to null:

```
if (pa == 0) { ... }
if (pb != 0) { ... }
```

Note: Comparing pointers pointing to different objects/arrays can be performed at programmer's own responsibility — a precise overview of data's physical storage is required

Pointer Addition

You can use operators `+`, `++`, and `+=` to add an integral value to a pointer. The result of addition is defined only if the pointer points to an element of an array and if the result is a pointer pointing to the same array (or one element beyond it).

If a pointer is declared to point to `type`, adding an integral value `n` to the pointer increments the pointer value by `n * sizeof(type)` as long as the pointer remains within the legal range (first element to one beyond the last element). If `type` has a size of 10 bytes, then adding 5 to a pointer to `type` advances the pointer 50 bytes in memory. In case of the `void` type, the size of a step is one byte.

For example:

```
int a[10];           /* array a containing 10 elements of type int */
int *pa = &a[0];    /* pa is pointer to int, pointing to a[0] */
*(pa + 3) = 6;      /* pa+3 is a pointer pointing to a[3], so a[3] now equals 6 */
pa++;              /* pa now points to the next element of array a: a[1] */
```

There is no such element as “one past the last element”, of course, but the pointer is allowed to assume such value. C “guarantees” that the result of addition is defined even when pointing to one element past array. If `P` points to the last array element, `P + 1` is legal, but `P + 2` is undefined.

This allows you to write loops which access the array elements in a sequence by means of incrementing pointer — in the last iteration you will have the pointer pointing to one element past the array, which is legal. However, applying an indirection operator (`*`) to a “pointer to one past the last element” leads to undefined behavior.

For example:

```
void f (some_type a[], int n) {
    /* function f handles elements of array a; */
    /* array a has n elements of type some_type */

    int i;
    some_type *p=&a[0];

    for ( i = 0; i < n; i++ ) {
        /* .. here we do something with *p .. */
        p++; /* .. and with the last iteration p exceeds
              the last element of array a */
    }
    /* at this point, *p is undefined! */
}
```

Pointer Subtraction

Similar to addition, you can use operators `-`, `--`, and `--` to subtract an integral value from a pointer.

Also, you may subtract two pointers. The difference will be equal to the distance between two pointed addresses, in bytes.

For example:

```
int a[10];
int *pi1 = &a[0];
int *pi2 = &a[4];
i = pi2 - pi1;      /* i equals 8 */
pi2 -= (i >> 1);   /* pi2 = pi2 - 4: pi2 now points to [0] */
```

Structures

A structure is a derived type usually representing a user-defined collection of named members (or components). These members can be of any type, either fundamental or derived (with some restrictions to be discussed later), in any sequence. In addition, a structure member can be a bit field.

Unlike arrays, structures are considered to be single objects. The mikroC PRO for dsPIC30/33 and PIC24 structure type lets you handle complex data structures almost as easily as single variables.

The mikroC PRO for dsPIC30/33 and PIC24 supports anonymous structures.

Structure Declaration and Initialization

Structures are declared using the keyword `struct`:

```
struct tag {member-declarator-list};
```

Here, `tag` is the name of a structure; `member-declarator-list` is a list of structure members, actually a list of variable declarations. Variables of structured type are declared the same as variables of any other type.

The member type cannot be the same as the struct type being currently declared. However, a member can be a pointer to the structure being declared, as in the following example:

```
struct mystruct {mystruct s;}; /* illegal! */
struct mystruct {mystruct *ps;}; /* OK */
```

Also, a structure can contain previously defined structure types when declaring an instance of declared structure. Here is an example:

```
/* Structure defining a dot: */
struct Dot {float x, y;};

/* Structure defining a circle: */
struct Circle {
    float r;
    struct Dot center;
} o1, o2;
/* declare variables o1 and o2 of Circle */
```

Note that the structure tag can be omitted, but then additional objects of this type cannot be declared elsewhere. For more information, see the Untagged Structures below.

Structure is initialized by assigning it a comma-delimited sequence of values within braces, similar to array. For example:

```
/* Referring to declarations from the example above: */

/* Declare and initialize dots p and q: */
struct Dot p = {1., 1.}, q = {3.7, -0.5};

/* Declare and initialize circle o1: */
struct Circle o1 = {1., {0., 0.}}; // radius is 1, center is at (0, 0)
```

Incomplete Declarations

Incomplete declarations are also known as forward declarations. A pointer to a structure type **A** can legally appear in the declaration of another structure **B** before **A** has been declared:

```
struct A; // incomplete
struct B {struct A *pa;};
struct A {struct B *pb;};
```

The first appearance of **A** is called incomplete because there is no definition for it at that point. An incomplete declaration is allowed here, because the definition of **B** doesn't need the size of **A**.

Untagged Structures and Typedefs

If the structure tag is omitted, an *untagged structure* is created. The untagged structures can be used to declare the identifiers in the comma-delimited `member-declarator-list` to be of the given structure type (or derived from it), but additional objects of this type cannot be declared elsewhere.

It is possible to create a typedef while declaring a structure, with or without tag:

```
/* With tag: */
typedef struct mystruct { ... } Mystruct;
Mystruct s, *ps, arrs[10]; /* same as struct mystruct s, etc. */

/* Without tag: */
typedef struct { ... } Mystruct;
Mystruct s, *ps, arrs[10];
```

Usually, there is no need to use both `tag` and `typedef`: either can be used in structure type declarations.

Untagged structure and union members are ignored during initialization.

Anonymous Structures

mikroC PRO for dsPIC30/33 and PIC24 allows you to declare a structure variable within another structure without giving it a name.

These nested structures are called *anonymous structures*.

You can access the members of an anonymous structure as if they were members in the containing structure:

```
struct phone{
    int  areacode;
    long number;
};

struct person {
    char  name[30];
    char  gender;
    int   age;
    int   weight;
    struct phone;    // Anonymous structure; no name needed
} Jim;

    Jim.number = 1234567;
}
```

Related topics: Working with structures

Working with Structures

Structures represent user-defined types. A set of rules regarding the application of structures is strictly defined.

Assignment

Variables of the same structured type may be assigned one to another by means of simple assignment operator (=). This will copy the entire contents of the variable to destination, regardless of the inner complexity of a given structure.

Note that two variables are of the same structured type *only* if they are both defined by the same instruction or using the same type identifier. For example:

```
/* a and b are of the same type: */
struct {int m1, m2;} a, b;

/* But c and d are _not_ of the same type although
   their structure descriptions are identical: */
struct {int m1, m2;} c;
struct {int m1, m2;} d;
```

Size of Structure

The size of the structure in memory can be retrieved by means of the operator `sizeof`. It is not necessary that the size of the structure is equal to the sum of its members' sizes. It is often greater due to certain limitations of memory storage.

Structures and Functions

A function can return a structure type or a pointer to a structure type:

```
mystruct func1(void);    /* func1() returns a structure */
mystruct *func2(void);  /* func2() returns pointer to structure */
```

A structure can be passed as an argument to a function in the following ways:

```
void func1(mystruct s);    /* directly */
void func2(mystruct *sptr); /* via a pointer */
```

Structure Member Access

Structure and union members are accessed using the following two selection operators:

- . (period)
- -> (right arrow)

The operator `.` is called the direct member selector and it is used to directly access one of the structure's members. Suppose that the object `s` is of the struct type `S` and `m` is a member identifier of the type `M` declared in `s`, then the expression

```
s.m // direct access to member m
```

is of the type `M`, and represents the member object `m` in `s`.

The operator `->` is called the indirect (or pointer) member selector. Suppose that the object `s` is of the struct type `S` and `ps` is a pointer to `s`. Then if `m` is a member identifier of the type `M` declared in `s`, the expression

```
ps->m // indirect access to member m;  
      // identical to (*ps).m
```

is of the type `M`, and represents the member object `m` in `s`. The expression `ps->m` is a convenient shorthand for `(*ps).m`.

For example:

```
struct mystruct {  
    int i;  
    char str[21];  
    double d;  
} s, *sptr = &s;  
  
...  
  
s.i = 3;           // assign to the i member of mystruct s  
sptr -> d = 1.23; // assign to the d member of mystruct s
```

The expression `s.m` is lvalue, providing that `s` is lvalue and `m` is not an array type. The expression `sptr->m` is an lvalue unless `m` is an array type.

Accessing Nested Structures

If the structure **B** contains a field whose type is the structure **A**, the members of **A** can be accessed by two applications of the member selectors:

```
struct A {
    int j; double x;
};
struct B {
    int i; struct A aa; double d;
} s, *sptr;

...

s.i = 3;           // assign 3 to the i member of B
s.aa.j = 2;       // assign 2 to the j member of A
sptr->d = 1.23;    // assign 1.23 to the d member of B
sptr->aa.x = 3.14; // assign 3.14 to x member of A
```

Structure Uniqueness

Each structure declaration introduces a unique structure type, so that in

```
struct A {
    int i,j; double d;
} aa, aaa;

struct B {
    int i,j; double d;
} bb;
```

the objects **aa** and **aaa** are both of the type **struct A**, but the objects **aa** and **bb** are of different structure types. Structures can be assigned only if the source and destination have the same type:

```
aa = aaa;        /* OK: same type, member by member assignment */
aa = bb;        /* ILLEGAL: different types */

/* but you can assign member by member: */
aa.i = bb.i;
aa.j = bb.j;
aa.d = bb.d;
```

Unions

Union types are derived types sharing many of syntactic and functional features of structure types. The key difference is that a union members share the same memory space.

Note: The mikroC PRO for PIC supports anonymous unions.

Union Declaration

Unions have the same declaration as structures, with the keyword `union` used instead of `struct`:

```
union tag { member-declarator-list };
```

Unlike structures' members, the value of only one of union's members can be stored at any time. Here is a simple example:

```
union myunion { // union tag is 'myunion'
    int i;
    double d;
    char ch;
} mu, *pm;
```

The identifier `mu`, of the type `myunion`, can be used to hold a 2-byte `int`, 4-byte `double` or single-byte `char`, but only one of them at a certain moment. The identifier `pm` is a pointer to union `myunion`.

Size of Union

The size of a union is the size of its largest member. In our previous example, both `sizeof(union myunion)` and `sizeof(mu)` return 4, but 2 bytes are unused (padded) when `mu` holds the `int` object, and 3 bytes are unused when `mu` holds `char`.

Union Member Access

Union members can be accessed with the structure member selectors (`.` and `->`), be careful when doing this:

```
/* Referring to declarations from the example above: */
pm = &mu;
mu.d = 4.016;
tmp = mu.d; // OK: mu.d = 4.016
tmp = mu.i; // peculiar result

pm->i = 3;
tmp = mu.i; // OK: mu.i = 3
```

The third line is legal, since `mu.i` is an integral type. However, the bit pattern in `mu.i` corresponds to parts of the previously assigned `double`. As such, it probably won't provide an useful integer interpretation.

When properly converted, a pointer to a union points to each of its members, and vice versa.

Anonymous Unions

Anonymous unions are unions that are declared without `tag` or `declarator`:

```
union { member-declarator-list };
```

Such union declarations do not declare `types`; they declare an unnamed `objects`.
The name of each union member must be unique within the scope where the union is declared.

In C, an anonymous union can have a tag; it cannot have declarators. Names declared in an anonymous union are used directly, like nonmember variables.

In addition to the restrictions listed above in Union, anonymous unions are subject to additional restrictions:

- They must also be declared as `static` if declared in global scope. If declared in local scope, they must be either `static` or `automatic`, not `external`
- They can have only public members; private and protected members in anonymous unions generate errors.
- They cannot have function members.

Here is a simple example:

```
union { // no union tag
    int i;
    float f;
    union { // no union tag
        unsigned char uc;
        char c;
    }; // no declarator
}; // no declarator
```

Anonymous Union Member Access

Anonymous union members are accessed directly because they are in the scope containing the anonymous union :

```
// Referring to declarations from the example above:
i = 1;
f = 3.14;
uc = 'c';
c = 'u';
```

Bit Fields

Bit fields are specified numbers of bits that may or may not have an associated identifier. Bit fields offer a way of subdividing structures into named parts of user-defined sizes.

Structures and unions can contain bit fields that can be up to 16 bits.

You cannot take the address of a bit field.

Note: If you need to handle specific bits of 8-bit variables (`char` and `unsigned short`) or registers, you don't need to declare bit fields.

Much more elegant solution is to use the mikroC PRO for dsPIC30/33 and PIC24's intrinsic ability for individual bit access — see [Accessing Individual Bits](#) for more information.

Bit Fields Declaration

Bit fields can be declared only in structures and unions. Declare a structure normally and assign individual fields like this (fields need to be `unsigned`):

```
struct tag {  
    unsigned bitfield-declarator-list;  
}
```

Here, `tag` is an optional name of the structure; `bitfield-declarator-list` is a list of bit fields. Each component identifier requires a colon and its width in bits to be explicitly specified. Total width of all components cannot exceed two bytes (16 bits).

As an object, bit fields structure takes two bytes. Individual fields are packed within two bytes from right to left. In `bitfield-declarator-list`, you can omit identifier(s) to create an artificial “padding”, thus skipping irrelevant bits.

For example, if there is a need to manipulate only bits 2–4 of a register as one block, create a structure like this:

```
struct {  
    unsigned : 2, // Skip bits 0 and 1, no identifier here  
    mybits : 3; // Relevant bits 2, 3 and 4  
                // Bits 5, 6 and 7 are implicitly left out  
} myreg;
```

Here is an example:

```
typedef struct {  
    lo_nibble : 4;  
    hi_nibble : 4;  
    high_byte : 8;} myunsigned;
```

which declares the structured type `myunsigned` containing three components: `lo_nibble` (bits 3..0), `hi_nibble` (bits 7..4) and `high_byte` (bits 15..8).

Bit Fields Access

Bit fields can be accessed in the same way as the structure members. Use direct and indirect member selector (`.` and `->`). For example, we could work with our previously declared `myunsigned` like this:

```
// Declare a bit field Value_For_PortB:
myunsigned Value_For_PortB;

// Declare a pointer to mybitfield type:
mybitfield *TimerControl;

void main() {
    TimerControl = (mybitfield *) (void *) &T2CON ; // explicit casting of pointer to
    T2CON, so it can be assigned

    ...
    Value_For_PortB.lo_nibble = 7;
    Value_For_PortB.hi_nibble = 0x0C;
    Value_For_PortB.high_byte = 0xAA;
    PORTB = *(unsigned *) (void *)&Value_For_PortB;
        // typecasting :
        // 1. address of structure to pointer to void
        // 2. pointer to void to pointer to unsigned
        // 3. dereferencing to obtain the value
}
```

Types Conversions

The mikroC PRO for dsPIC30/33 and PIC24 is a strictly typed language, with each operator, statement and function demanding appropriately typed operands/arguments. However, we often have to use objects of “mismatching” types in expressions. In that case, *type conversion* is needed.

Conversion of object of one type means that object’s type is changed into another type. The mikroC PRO for dsPIC30/33 and PIC24 defines a set of standard conversions for built-in types, provided by compiler when necessary. For more information, refer to the Standard Conversions.

Conversion is required in the following situations:

- if a statement requires an expression of particular type (according to language definition), and we use an expression of different type,
- if an operator requires an operand of particular type, and we use an operand of different type,
- if a function requires a formal parameter of particular type, and we pass it an object of different type,
- if an expression following the keyword `return` does not match the declared function return type,
- if initializing an object (in declaration) with an object of different type.

In these situations, compiler will provide an automatic implicit conversion of types, without any programmer’s interference. Also, the programmer can demand conversion explicitly by means of the *typecast* operator. For more information, refer to the Explicit Typecasting.

Standard Conversions

Standard conversions are built in the mikroC PRO for dsPIC30/33 and PIC24. These conversions are performed automatically, whenever required in the program. They can also be explicitly required by means of the typecast operator (refer to the Explicit Typecasting).

The basic rule of automatic (implicit) conversion is that the operand of simpler type is converted (promoted) to the type of more complex operand. Then, the type of the result is that of more complex operand.

Arithmetic Conversions

When using arithmetic expression, such as `a + b`, where `a` and `b` are of different arithmetic types, the mikroC PRO for dsPIC30/33 and PIC24 performs implicit type conversions before the expression is evaluated. These standard conversions include promotions of “lower” types to “higher” types in the interests of accuracy and consistency.

Assigning a signed character object (such as a variable) to an integral object results in automatic sign extension. Objects of type `signed char` always use sign extension; objects of type `unsigned char` always has its high byte set to zero when converted to `int`.

Converting a longer integral type to a shorter type truncates the higher order bits and leaves low-order bits unchanged. Converting a shorter integral type to a longer type either sign-extends or zero-fills the extra bits of the new value, depending on whether the shorter type is signed or unsigned, respectively.

Note: Conversion of floating point data into integral value (in assignments or via explicit typecast) produces correct results only if the `float` value does not exceed the scope of destination integral type.

In details:

Here are the steps the mikroC PRO for dsPIC30/33 and PIC24 uses to convert the operands in an arithmetic expression:

First, any small integral types are converted according to the following rules:

1. `bit` converts to `char`
2. `char` converts to `int`
3. `signed char` converts to `int`, with the same value
4. `short` converts to `int`, with the same value, sign-extended
5. `unsigned short` converts to `unsigned int`, with the same value, zero-filled
6. `enum` converts to `int`, with the same value

After this, any two values associated with an operator are either `int` (including the `long` and `unsigned` modifiers) or `float` (equivalent with `double` and `long double` in the mikroC PRO for dsPIC30/33 and PIC24).

1. If either operand is `float`, the other operand is converted to `float`.
2. Otherwise, if either operand is `unsigned long`, the other operand is converted to `unsigned long`.
3. Otherwise, if either operand is `long`, then the other operand is converted to `long`.
4. Otherwise, if either operand is `unsigned`, then the other operand is converted to `unsigned`.
5. Otherwise, both operands are `int`.

The result of the expression is the same type as that of the two operands.

Here are several examples of implicit conversion:

```
2 + 3.1      /* → 2. + 3.1 → 5.1 */
5 / 4 * 3.   /* → (5/4)*3. → 1*3. → 1.*3. → 3. */
3. * 5 / 4   /* → (3.*5)/4 → (3.*5.)/4 → 15./4 → 15./4. → 3.75 */
```

Pointer Conversions

Pointer types can be converted to other pointer types using the typecasting mechanism:

```
char *str;
int *ip;
str = (char *)ip;
```

More generally, the cast `type*` will convert a pointer to type “pointer to `type`”.

Explicit Types Conversions (Typecasting)

In most situations, compiler will provide an automatic implicit conversion of types where needed, without any user’s interference. Also, the user can explicitly convert an operand to another type using the prefix unary `typecast` operator:

```
(type) object
```

This will convert `object` to a specified `type`. Parentheses are mandatory.

For example:

```
/* Let's have two variables of char type: */
char a, b;

/* Following line will coerce a to unsigned int: */
(unsigned int) a;

/* Following line will coerce a to double,
   then coerce b to double automatically,
   resulting in double type value: */
(double) a + b;    // equivalent to ((double) a) + b;
```

Declarations

A declaration introduces one or several names to a program – it informs the compiler what the name represents, what its type is, what operations are allowed with it, etc. This section reviews concepts related to declarations: declarations, definitions, declaration specifiers, and initialization.

The range of objects that can be declared includes:

- Variables
- Constants
- Functions
- Types
- Structure, union, and enumeration tags
- Structure members
- Union members
- Arrays of other types
- Statement labels
- Preprocessor macros

Declarations and Definitions

Defining declarations, also known as *definitions*, beside introducing the name of an object, also establish the creation (where and when) of an object; that is, the allocation of physical memory and its possible initialization. Referencing declarations, or just *declarations*, simply make their identifiers and types known to the compiler.

Here is an overview. Declaration is also a definition, except if:

- it declares a function without specifying its body
- it has the `extern` specifier, and has no initializer or body (in case of func.)
- it is the `typedef` declaration

There can be many referencing declarations for the same identifier, especially in a multifile program, but only one defining declaration for that identifier is allowed.

For example:

```
/* Here is a nondefining declaration of function max; */
/* it merely informs compiler that max is a function */
int max();

/* Here is a definition of function max: */
int max(int x, int y) {
    return (x >= y) ? x : y;
}

/* Definition of variable i: */
int i;

/* Following line is an error, i is already defined! */
int i;
```

Declarations and Declarators

The declaration contains specifier(s) followed by one or more identifiers (declarators). The declaration begins with optional storage class specifiers, type specifiers, and other modifiers. The identifiers are separated by commas and the list is terminated by a semicolon.

Declarations of variable identifiers have the following pattern:

```
storage-class [type-qualifier] type var1 [=init1], var2 [=init2], ... ;
```

where `var1`, `var2`, ... are any sequence of distinct identifiers with optional initializers. Each of the variables is declared to be of `type`; if omitted, `type` defaults to `int`. The specifier `storage-class` can take the values `extern`, `static`, `register`, or the default `auto`. Optional `type-qualifier` can take values `const` or `volatile`. For more details, refer to Storage Classes and Type Qualifiers.

For example:

```
/* Create 3 integer variables called x, y, and z
   and initialize x and y to the values 1 and 2, respectively: */
int x = 1, y = 2, z; // z remains uninitialized

/* Create a floating-point variable q with static modifier,
   and initialize it to 0.25: */
static float q = .25;
```

These are all defining declarations; storage is allocated and any optional initializers are applied.

Linkage

An executable program is usually created by compiling several independent *translation units*, then linking the resulting object files with preexisting libraries. A term translation unit refers to a source code file together with any included files, but without the source lines omitted by conditional preprocessor directives. A problem arises when the same identifier is declared in different scopes (for example, in different files), or declared more than once in the same scope.

The *linkage* is a process that allows each instance of an identifier to be associated correctly with one particular object or function. All identifiers have one of two linkage attributes, closely related to their scope: external linkage or internal linkage. These attributes are determined by the placement and format of your declarations, together with an explicit (or implicit by default) use of the storage class specifier `static` or `extern`.

Each instance of a particular identifier with external linkage represents the same object or function throughout the entire set of files and libraries making up the program. Each instance of a particular identifier with internal linkage represents the same object or function within one file only.

Linkage Rules

Local names have internal linkage; the same identifier can be used in different files to signify different objects. Global names have external linkage; identifier signifies the same object throughout all program files.

If the same identifier appears with both internal and external linkage within the same file, the identifier will have internal linkage.

Internal Linkage Rules

1. names having file scope, explicitly declared as `static`, have internal linkage
2. names having file scope, explicitly declared as `const` and not explicitly declared as `extern`, have internal linkage
3. `typedef` names have internal linkage
4. enumeration constants have internal linkage

External Linkage Rules

1. names having file scope, that do not comply to any of previously stated internal linkage rules, have external linkage

The storage class specifiers `auto` and `register` cannot appear in an external declaration. No more than one external definition can be given for each identifier in a translation unit declared with internal linkage. An external definition is an external declaration that defines an object or a function and also allocates a storage. If an identifier declared with external linkage is used in an expression (other than as part of the operand of `sizeof`), then exactly one external definition of that identifier must be somewhere in the entire program.

Storage Classes

Associating identifiers with objects requires each identifier to have at least two attributes: storage class and type (sometimes referred to as data type). The mikroC PRO for dsPIC30/33 and PIC24 compiler deduces these attributes from implicit or explicit declarations in the source code.

A storage class dictates the location (data segment, register, heap, or stack) of object and its duration or lifetime (the entire running time of the program, or during execution of some blocks of code). A storage class can be established by the syntax of a declaration, by its placement in the source code, or by both of these factors:

storage-class type identifier

The storage class specifiers in the mikroC PRO for dsPIC30/33 and PIC24 are:

- `auto`
- `register`
- `static`
- `extern`

Auto

The auto storage-class specifier declares an automatic variable (a variable with a local lifetime). An auto variable is visible only within the block in which it is declared.

The auto storage-class specifier can only be applied to names of variables declared in a block or to names of function parameters.

However, these names have automatic storage by default. Therefore the auto storage class specifier is usually redundant in a data declaration.

Register

The register storage-class specifier is used to define local variables that should be stored in a register instead of RAM. At the moment this modifier has no special meaning in mikroC PRO for dsPIC30/33 and PIC24.

mikroC PRO for dsPIC30/33 and PIC24 simply ignores requests for register allocation.

Static

The static storage class specifier lets you define variables or functions with internal linkage, which means that each instance of a particular identifier represents the same variable or function within one file only.

In addition, variables declared static have static storage duration, which means that memory for these variables is allocated when the program begins running and is freed when the program terminates.

Static storage duration for a variable is different from file or global scope. A variable can have static duration, but local scope.

Extern

The extern storage class specifier lets you declare objects that can be used in several source files. An extern declaration makes a described variable usable by the succeeding part of the current source file.

This declaration does not replace the definition. It is used to describe a variable that is externally defined. An extern declaration can appear outside a function or at the beginning of a block.

If the declaration describes a function or appears outside a function and describes an object with external linkage, the keyword extern is optional.

If a declaration for an identifier already exists within the file scope, any extern declaration of the same identifier found within a block refers to the same object.

If no other declaration for the identifier exists within the file scope, the identifier has external linkage.

See Linkage for more information.

Type Qualifiers

The type qualifiers `const` and `volatile` are optional in declarations and do not actually affect the type of declared object.

Qualifier `const`

The `const` qualifier is used to indicate that variable value cannot be changed. Its value is set at initialization.

The mikroC PRO for dsPIC30/33 and PIC24 treats objects declared with the `const` qualifier the same as literals or preprocessor constants. If the user tries to change an object declared with the `const` qualifier compiler will report an error.

For example:

```
const double PI = 3.14159;
```

Qualifier `volatile`

The `volatile` qualifier indicates that variable values can be changed both with or without user's interference in the program. The compiler should not optimize such variable.

Typedef Specifier

The `typedef` declaration introduces a name that, within its scope, becomes a synonym for the specified type. You can use typedef declarations to construct shorter or more meaningful names for types already defined by the language or declared by the user.

Typedef names allow you to encapsulate implementation details that may change. Unlike the `struct`, `union`, and `enum` declarations, the `typedef` declarations do not introduce new types, but new names for existing types.

The specifier `typedef` stands first in the declaration:

```
typedef <type_definition> synonym;
```

The `typedef` keyword assigns `synonym` to `<type_definition>`. The `synonym` needs to be a valid identifier.

A declaration starting with the `typedef` specifier does not introduce an object or a function of a given type, but rather a new name for a given type. In other words, the `typedef` declaration is identical to a "normal" declaration, but instead of objects, it declares types. It is a common practice to name custom type identifiers with starting capital letter — this is not required by the mikroC PRO for dsPIC30/33 and PIC24.

For example:

```
/* Let's declare a synonym for "unsigned long int" */
typedef unsigned long int Distance;

/* Now, synonym "Distance" can be used as type identifier: */
Distance i; // declare variable i of unsigned long int
```

In the `typedef` declaration, as in any other declaration, several types can be declared at once. For example:

```
typedef int *Pti, Array[10];
```

Here, `Pti` is a synonym for type “pointer to `int`”, and `Array` is a synonym for type “array of 10 `int` elements”.

asm Declaration

The mikroC PRO for dsPIC30/33 and PIC24 allows embedding assembly in the source code by means of the `asm` declaration. The declarations `_asm` and `__asm` are also allowed in the mikroC PRO for dsPIC30/33 and PIC24 and have the same meaning. Note that numerals cannot be used as absolute addresses for SFR or GPR variables in assembly instructions. Symbolic names may be used instead (listing will display these names as well as addresses).

Assembly instructions can be grouped by the `asm` keyword (or `_asm`, or `__asm`):

```
asm {
    block of assembly instructions
}
```

The mikroC PRO for dsPIC30/33 and PIC24 comments (both single-line and multi-line) are allowed in embedded assembly code.

The only types whose name remains the same in `asm` as it is in the mikroC PRO for dsPIC30/33 and PIC24 are registers, e.g. `INTCON`, `PORTB`, `WREG`, `GIE`, etc.

Accessing variables

Depending on the place of declaration, accessing a variable can be done in several ways:

- Accessing global variable:

1. If declared as static (visible only in the file where it was declared):
`<source_file_name> <variable_name>.`
2. If declared as a non-static global (visible throughout the whole project): `__<variable_name>.`
3. If accessing registers (declared through `register`, `rx` or `sfr` specifiers, visible throughout the whole project): `<variable_name>.`

- Accessing local variable: `<routine_name> <variable_name>.`

- Accessing routine parameter: `FARG_<routine_name>_<variable_name>.`

Here is an example of using asm instructions:

```
unsigned myvar absolute 0x2678;
unsigned long myvar1;
const char msg[] = "Test" absolute 0x3652;

void main() org 0x11234 {
    myvar = 5;
    myvar1 = 0xABCDEFAB;

    asm {
        MOV _myvar, w0                ; move myvar to W0
        nop
        MOV #6, W0                    ; move literal 6 to W0
        MOV W0, _myvar                ; move contents of W0 to myvar
        MOV #lo_addr(_myvar), W1     ; retrieve low address word of _myvar and move it to W1
(0x2678 -> W1)
        MOV #hi_addr(_myvar), W1     ; retrieve high address word of _myvar and move it to
W1 (0x0000 -> W1)
        MOV #lo_addr(__main_Label1), W0 ; retrieve lo address word of Label1 and move it
W0 ( PC(Label1) ) -> W0
        MOV #hi_addr(_main), W0     ; retrieve hi address byte of main routine and move it
to W0 (0x0001 -> W1)
        MOV #lo_addr(msg2), W0      ; retrieve low address word of constant msg
and move it to W0 (0x3652 -> W1)
        MOV _myvar1+2, W1           ; accessing hi word of myvar1 variable and
move it to W1 (0xABCD -> W1)
    }
    Label1:
    asm MOV #hi_addr(__main_Label1), W0 // retrieve hi address word of Label1 and move
it W0 (PC(Label1)) -> W0
    goto Label1;
}
```

When using asm instructions that expect parameters like `lit1`, `lit4`, `slit6`, `slit6`, `bit4`, etc. be sure to precede them with the '#' (hash symbol) to ensure proper functioning.

Example:

```
BSET f, #5                ; set bit #5 in f register
MOV #16000, Wnd           ; move number #16000 to destination working register
ADD Ws, #-5, Acc         ; add number #-5 to accumulator
```

Asm code and SSA optimization

If asm code is mixed with the C code, keep in mind that the generated code can substantially differ when SSA optimization option is enabled or disabled.

This is due to the fact that SSA optimization uses certain working registers to store routine parameters (W10-W13), rather than storing them onto the function frame.

Because of this, user must be very careful when writing asm code as existing values in the working registers used by SSA optimization can be overwritten.

To avoid this, it is recommended that user includes desired asm code in a separate routine.

Initialization

The initial value of a declared object can be set at the time of declaration (*initialization*). A part of the declaration which specifies the initialization is called *initializer*.

Initializers for globals and `static` objects must be constants or constant expressions. The initializer for an automatic object can be any legal expression that evaluates to an assignment-compatible value for the type of the variable involved.

Scalar types are initialized with a single expression, which can optionally be enclosed in braces. The initial value of an object is that of the expression; the same constraints for type and conversions as for simple assignments are applied to initializations too.

For example:

```
int i = 1;
char *s = "hello";
struct complex c = {0.1, -0.2};
// where 'complex' is a structure (float, float)
```

For structures or unions with automatic storage duration, the initializer must be one of the following:

- An initializer list.
- A single expression with compatible union or structure type. In this case, the initial value of the object is that of the expression.

For example:

```
struct dot {int x; int y; } m = {30, 40};
```

For more information, refer to Structures and Unions.

Also, you can initialize arrays of character type with a literal string, optionally enclosed in braces. Each character in the string, including the null terminator, initializes successive elements in the array. For more information, refer to Arrays.

Automatic Initialization

The mikroC PRO for dsPIC30/33 and PIC24 does not provide automatic initialization for objects. Uninitialized globals and objects with static duration will take random values from memory.

Functions

Functions are central to C programming. Functions are usually defined as subprograms which return a value based on a number of input parameters. Return value of the function can be used in expressions – technically, function call is considered to be an expression like any other.

C allows a function to create results other than its return value, referred to as *side effects*. Often, the function return value is not used at all, depending on the side effects. These functions are equivalent to *procedures* of other programming languages, such as Pascal. C does not distinguish between procedure and function – functions play both roles.

Each program must have a single external function named `main` marking the entry point of the program. Functions are usually declared as prototypes in standard or user-supplied header files, or within program files. Functions have external linkage by default and are normally accessible from any file in the program. This can be restricted by using the `static` storage class specifier in function declaration (see Storage Classes and Linkage).

Note: Check the dsPIC30/33 and PIC24 Specifics for more information on functions' limitations on the dsPIC30/33 and PIC24 MCUs.

Function Declaration

Functions are declared in user's source files or made available by linking precompiled libraries. The declaration syntax of the function is:

```
type function_name(parameter-declarator-list);
```

The `function_name` must be a valid identifier. This name is used to call the function; see Function Calls for more information.

`type` represents the type of function result, and can be of any standard or user-defined type. For functions that do not return value the `void` type should be used. The type can be omitted in global function declarations, and function will assume the `int` type by default.

Function type can also be a pointer. For example, `float*` means that a function result is a pointer to float. The generic pointer `void*` is also allowed.

The function *cannot* return an array or another function.

Within parentheses, `parameter-declarator-list` is a list of formal arguments that function takes. These declarators specify the type of each function parameter. The compiler uses this information to check validity of function calls. If the list is empty, a function does not take any arguments. Also, if the list is `void`, a function also does not take any arguments; note that this is the *only* case when `void` can be used as an argument's type.

Unlike variable declaration, each argument in the list needs its own type specifier and possible qualifier `const` or `volatile`.

Function Prototypes

A function can be defined only once in the program, but can be declared several times, assuming that the declarations are compatible. When declaring a function, the formal argument's identifier does not have to be specified, but its type does.

This kind of declaration, commonly known as the *function prototype*, allows better control over argument number, type checking and type conversions. The name of a parameter in function prototype has its scope limited to the prototype. This allows one parameter identifier to have different name in different declarations of the same function:

```
/* Here are two prototypes of the same function: */

int test(const char*)    /* declares function test */
int test(const char*p)  /* declares the same function test */
```

Function prototypes are very useful in documenting code. For example, the function `Cf_Init` takes two parameters: Control Port and Data Port. The question is, which is which? The function prototype:

```
void Cf_Init(char *ctrlport, char *dataport);
```

makes it clear. If a header file contains function prototypes, the user can read that file to get the information needed for writing programs that call these functions. If a prototype parameter includes an identifier, then the identifier is only used for error checking.

Function Definition

Function definition consists of its declaration and *function body*. The *function body* is technically a block – a sequence of local definitions and statements enclosed within braces `{}`. All variables declared within function body are local to the function, i.e. they have function scope.

The function itself can be defined only within the file scope, which means that function declarations cannot be nested.

To return the function result, use the return statement. The statement `return` in functions of the `void` type cannot have a parameter – in fact, the `return` statement can be omitted altogether if it is the last statement in the function body.

Here is a sample function definition:

```
/* function max returns greater one of its 2 arguments: */

int max(int x, int y) {
    return (x>=y) ? x : y;
}
```

Here is a sample function which depends on side effects rather than return value:

```
/* function converts Descartes coordinates (x,y) to polar (r,fi): */
#include <math.h>

void polar(double x, double y, double *r, double *fi) {
    *r = sqrt(x * x + y * y);
    *fi = (x == 0 && y == 0) ? 0 : atan2(y, x);
    return; /* this line can be omitted */
}
```

Functions reentrancy

Functions reentrancy is allowed. Remember that the dsPIC's and PIC24 has stack and memory limitations which can varies greatly between MCUs.

Function Calls and Argument Conversions

Function Calls

A function is called with actual arguments placed in the same sequence as their matching formal parameters. Use the function-call operator `()`:

```
function_name(expression_1, ... , expression_n)
```

Each `expression` in the function call is an *actual argument*. Number and types of actual arguments should match those of formal function parameters. If types do not match, implicit type conversions rules will be applied. Actual arguments can be of any complexity, but order of their evaluation is not specified.

Upon function call, all formal parameters are created as local objects initialized by the values of actual arguments. Upon return from a function, a temporary object is created in the place of the call, and it is initialized by the expression of the `return` statement. This means that the function call as an operand in complex expression is treated as a function result.

If the function has no result (type `void`) or the result is not needed, then the function call can be written as a self-contained expression.

In C, scalar arguments are always passed to the function by value. The function can modify the values of its formal parameters, but this has no effect on the actual arguments in the calling routine. A scalar object can be passed by the address if a formal parameter is declared as a pointer. The pointed object can be accessed by using the indirection operator `*`.

```
// For example, Soft_UART_Read takes the pointer to error variable,
// so it can change the value of an actual argument:
Soft_UART_Read(&error);

// The following code would be wrong; you would pass the value
// of error variable to the function:
Soft_UART_Read(error);
```

Argument Conversions

If a function prototype has not been previously declared, the mikroC PRO for dsPIC30/33 and PIC24 converts integral arguments to a function call according to the integral widening (expansion) rules described in Standard Conversions. If a function prototype is in scope, the mikroC PRO for dsPIC30/33 and PIC24 converts the passed argument to the type of the declared parameter according to the same conversion rules as in assignment statements.

If a prototype is present, the number of arguments must match. The types need to be compatible only to the extent that an assignment can legally convert them. The user can always use an explicit cast to convert an argument to a type that is acceptable to a function prototype.

Note: If the function prototype does not match the actual function definition, the mikroC PRO for dsPIC30/33 and PIC24 will detect this if and only if that definition is in the same compilation unit as the prototype. If you create a library of routines with the corresponding header file of prototypes, consider including that header file when you compile the library, so that any discrepancies between the prototypes and actual definitions will be detected.

The compiler is also able to force arguments to change their type to a proper one. Consider the following code:

```
int limit = 32;
char ch = 'A';
long res;

// prototype
extern long func(long par1, long par2);

main() {
    ...
    res = func(limit, ch); // function call
}
```

Since the program has the function prototype for `func`, it converts `limit` and `ch` to `long`, using the standard rules of assignment, before it places them on the stack for the call to `func`.

Without the function prototype, `limit` and `ch` would be placed on the stack as an integer and a character, respectively; in that case, the stack passed to `func` will not match size or content that `func` expects, which can cause problems.

Ellipsis ('...') Operator

The ellipsis ('...') consists of three successive periods with no whitespace intervening. An ellipsis can be used in the formal argument lists of function prototypes to indicate a variable number of arguments, or arguments with varying types. For example:

```
void func (int n, char ch, ...);
```

This declaration indicates that `func` will be defined in such a way that calls must have at least two arguments, `int` and `char`, but can also have any number of additional arguments.

Example:

```
#include <stdarg.h>

int addvararg(char a1,...){
    va_list ap;
    char temp;
    va_start(ap,a1);

    while( temp = va_arg(ap,char))
        a1 += temp;
    return a1;
}

int res;
void main() {

    res = addvararg(1,2,3,4,5,0);

    res = addvararg(1,2,3,4,5,6,7,8,9,10,0);

}
```

Operators

Operators are tokens that trigger some computation when applied to variables and other objects in an expression.

- Arithmetic Operators
- Assignment Operators
- Bitwise Operators
- Logical Operators
- Reference/Indirect Operators
- Relational Operators
- Structure Member Selectors

- Comma Operator ,
- Conditional Operator ? :

- Array subscript operator []
- Function call operator ()

- `sizeof` Operator

- Preprocessor Operators # and ##

Operators Precedence and Associativity

There are 15 precedence categories, some of them contain only one operator. Operators in the same category have equal precedence.

If duplicates of operators appear in the table, the first occurrence is unary and the second binary. Each category has an associativity rule: left-to-right (→), or right-to-left (←). In the absence of parentheses, these rules resolve a grouping of expressions with operators of equal precedence.

Precedence	Operands	Operators	Asociativity
15	2	() [] . ->	→
14	1	! ~ ++ -- + - * & (type) sizeof	←
13	2	* / %	→
12	2	+ -	→
11	2	<< >>	→
10	2	< <= > >=	→
9	2	== !=	→
8	2	&	→
7	2	^	→
6	2		→
5	2	&&	→
4	2		→
3	3	?:	←
2	2	= *= /= %= += -= &= ^= = <<= >>=	←
1	2	,	→

Note: Operator * is context sensitive and can also represent the pointer reference operator.

Binary Arithmetic Operators

Division of two integers returns an integer, while remainder is simply truncated:

```
/* for example: */
7 / 4;          /* equals 1 */
7 * 3 / 4;     /* equals 5 */

/* but: */
7. * 3. / 4.;  /* equals 5.25 because we are working with floats */
```

Remainder operand % works only with integers; the sign of result is equal to the sign of the first operand:

```
/* for example: */
9 % 3;         /* equals 0 */
7 % 3;         /* equals 1 */
-7 % 3;        /* equals -1 */
```

Arithmetic operators can be used for manipulating characters:

```
'A' + 32;      /* equals 'a' (ASCII only) */
'G' - 'A' + 'a'; /* equals 'g' (both ASCII and EBCDIC) */
```

Unary Arithmetic Operators

Unary operators ++ and -- are the only operators in C which can be either prefix (e.g. ++k, --k) or postfix (e.g. k++, k--).

When used as prefix, operators ++ and -- (preincrement and predecrement) add or subtract one from the value of the operand *before* the evaluation. When used as suffix, operators ++ and -- (postincrement and postdecrement) add or subtract one from the value of the operand *after* the evaluation.

For example:

```
int j = 5;
j = ++k;          /* k = k + 1, j = k, which gives us j = 6, k = 6 */
```

but:

```
int j = 5;
j = k++;          /* j = k, k = k + 1, which gives us j = 5, k = 6 */
```

Relational Operators

Use relational operators to test equality or inequality of expressions. If an expression evaluates to be true, it returns 1; otherwise it returns 0.

All relational operators associate from left to right.

Relational Operators Overview

Operator	Operation	Precedence
==	equal	9
!=	not equal	9
>	greater than	10
<	less than	10
>=	greater than or equal	10
<=	less than or equal	10

Relational Operators in Expressions

Precedence of arithmetic and relational operators is designated in such a way to allow complex expressions without parentheses to have expected meaning:

```
a + 5 >= c - 1.0 / e    /* → (a + 5) >= (c - (1.0 / e)) */
```

Do not forget that relational operators return either 0 or 1. Consider the following examples:

```
/* ok: */
5 > 7                /* returns 0 */
10 <= 20             /* returns 1 */

/* this can be tricky: */
8 == 13 > 5          /* returns 0, as: 8 == (13 > 5) → 8 == 1 → 0 */
14 > 5 < 3           /* returns 1, as: (14 > 5) < 3 → 1 < 3 → 1 */
a < b < 5            /* returns 1, as: (a < b) < 5 → (0 or 1) < 5 → 1 */
```

Bitwise Operators

Use the bitwise operators to modify individual bits of numerical operands.

Bitwise operators associate from left to right. The only exception is the bitwise complement operator `~` which associates from right to left.

Bitwise Operators Overview

Operator	Operation	Precedence
<code>&</code>	bitwise AND; compares pairs of bits and returns 1 if both bits are 1, otherwise returns 0	8
<code> </code>	bitwise (inclusive) OR; compares pairs of bits and returns 1 if either or both bits are 1, otherwise returns 0	6
<code>^</code>	bitwise exclusive OR (XOR); compares pairs of bits and returns 1 if the bits are complementary, otherwise returns 0	7
<code>~</code>	bitwise complement (unary); inverts each bit	14
<code><<</code>	bitwise shift left; moves the bits to the left, discards the far left bit and assigns 0 to the far right bit.	11
<code>>></code>	bitwise shift right; moves the bits to the right, discards the far right bit and if unsigned assigns 0 to the far left bit, otherwise sign extends	11

Logical Operations on Bit Level

<code>&</code>	0	1
0	0	0
1	0	1

<code> </code>	0	1
0	0	1
1	1	1

<code>^</code>	0	1
0	0	1
1	1	0

<code>~</code>	0	1
	1	0

Bitwise operators `&`, `|` and `^` perform logical operations on the appropriate pairs of bits of their operands. Operator `~` complements each bit of its operand. For example:

```
0x1234 & 0x5678      /* equals 0x1230 */

/* because ..

0x1234 : 0001 0010 0011 0100
0x5678 : 0101 0110 0111 1000
-----
&      : 0001 0010 0011 0000

.. that is, 0x1230 */
```

```
/* Similarly: */  
  
0x1234 | 0x5678;      /* equals 0x567C */  
0x1234 ^ 0x5678;     /* equals 0x444C */  
~ 0x1234;            /* equals 0xEDCB */
```

Note: Operator `&` can also be a pointer reference operator. Refer to Pointers for more information.

Bitwise Shift Operators

Binary operators `<<` and `>>` move the bits of the left operand by a number of positions specified by the right operand, to the left or right, respectively. Right operand has to be positive.

With shift left (`<<`), far left bits are discarded and “new” bits on the right are assigned zeroes. Thus, shifting unsigned operand to the left by n positions is equivalent to multiplying it by 2^n if all discarded bits are zero. This is also true for signed operands if all discarded bits are equal to a sign bit.

```
000001 << 5;      /* equals 000040 */  
0x3801 << 4;      /* equals 0x8010, overflow! */
```

With shift right (`>>`), far right bits are discarded and the “freed” bits on the left are assigned zeroes (in case of unsigned operand) or the value of a sign bit (in case of signed operand). Shifting operand to the right by n positions is equivalent to dividing it by 2^n .

```
0xFF56 >> 4;      /* equals 0xFFF5 */  
0xFF56u >> 4;     /* equals 0x0FF5 */
```

Bitwise vs. Logical

Do not forget of the principle difference between how bitwise and logical operators work. For example:

```
0222222 & 0555555; /* equals 000000 */  
0222222 && 0555555; /* equals 1 */  
  
~ 0x1234;          /* equals 0xEDCB */  
! 0x1234;          /* equals 0 */
```

Logical Operators

Operands of logical operations are considered true or false, that is non-zero or zero. Logical operators always return 1 or 0. Operands in a logical expression must be of scalar type.

Logical operators `&&` and `||` associate from left to right. Logical negation operator `!` associates from right to left.

Logical Operators Overview

Operator	Operation	Precedence
<code>&&</code>	logical AND	5
<code> </code>	logical OR	4
<code>!</code>	logical negation	14

Logical Operations

<code>&&</code>	0	x
0	0	0
x	0	1

<code> </code>	0	x
0	0	1
x	1	1

<code>!</code>	0	x
0	1	0

Precedence of logical, relational, and arithmetic operators was designated in such a way to allow complex expressions without parentheses to have an expected meaning:

```
c >= '0' && c <= '9';    /* reads as: (c >= '0') && (c <= '9') */
a + 1 == b || ! f(x);    /* reads as: ((a + 1) == b) || (! (f(x))) */
```

Logical AND `&&` returns 1 only if both expressions evaluate to be nonzero, otherwise returns 0. If the first expression evaluates to false, the second expression will not be evaluated. For example:

```
a > b && c < d;          /* reads as (a > b) && (c < d) */
/* if (a > b) is false (0), (c < d) will not be evaluated */
```

Logical OR `||` returns 1 if either of expression evaluates to be nonzero, otherwise returns 0. If the first expression evaluates to true, the second expression is not evaluated. For example:

```
a && b || c && d;        /* reads as: (a && b) || (c && d) */
/* if (a && b) is true (1), (c && d) will not be evaluated */
```

Logical Expressions and Side Effects

General rule regarding complex logical expressions is that the evaluation of consecutive logical operands stops at the very moment the final result is known. For example, if we have an expression `a && b && c` where `a` is false (0), then operands `b` and `c` will not be evaluated. This is very important if `b` and `c` are expressions, as their possible side effects will not take place!

Logical vs. Bitwise

Be aware of the principle difference between how bitwise and logical operators work. For example:

```
0222222 & 0555555    /* equals 000000 */
0222222 && 0555555    /* equals 1 */

~ 0x1234              /* equals 0xEDCB */
! 0x1234              /* equals 0 */
```

Conditional Operator ? :

The conditional operator `? :` is the only ternary operator in C. Syntax of the conditional operator is:

```
expression1 ? expression2 : expression3
```

The `expression1` is evaluated first. If its value is true, then `expression2` evaluates and `expression3` is ignored. If `expression1` evaluates to false, then `expression3` evaluates and `expression2` is ignored. The result will be a value of either `expression2` or `expression3` depending upon which of them evaluates.

Conditional operator associates from right to left.

Note: The fact that only one of these two expressions evaluates is very important if they are expected to produce side effects!

Here are a couple of practical examples:

```
/* Find max(a, b): */
max = ( a > b ) ? a : b;

/* Convert small letter to capital: */
/* (no parentheses are actually necessary) */
c = ( c >= 'a' && c <= 'z' ) ? ( c - 32 ) : c;
```

Conditional Operator Rules

`expression1` must be a scalar expression; `expression2` and `expression3` must obey one of the following rules:

1. Both expressions have to be of arithmetic type. `expression2` and `expression3` are subject to usual arithmetic conversions, which determines the resulting type.
2. Both expressions have to be of compatible `struct` or `union` types. The resulting type is a structure or union type of `expression2` and `expression3`.
3. Both expressions have to be of `void` type. The resulting type is `void`.
4. Both expressions have to be of type pointer to qualified or unqualified versions of compatible types. The resulting type is a pointer to a type qualified with all type qualifiers of the types pointed to by both expressions.
5. One expression is a pointer, and the other is a null pointer constant. The resulting type is a pointer to a type qualified with all type qualifiers of the types pointed to by both expressions.
6. One expression is a pointer to an object or incomplete type, and the other is a pointer to a qualified or unqualified version of `void`. The resulting type is that of the non-pointer-to-`void` expression.

Assignment Operators

Unlike many other programming languages, C treats value assignment as operation (represented by an operator) rather than instruction.

Simple Assignment Operator

For a common value assignment, a simple assignment operator (=) is used:

```
expression1 = expression2
```

The `expression1` is an object (memory location) to which the value of `expression2` is assigned. Operand `expression1` has to be lvalue and `expression2` can be any expression. The assignment expression itself is not lvalue.

If `expression1` and `expression2` are of different types, the result of the `expression2` will be converted to the type of `expression1`, if necessary. Refer to Type Conversions for more information.

Compound Assignment Operators

C allows more complex assignments by means of compound assignment operators. The syntax of compound assignment operators is:

```
expression1 op= expression2
```

where `op` can be one of binary operators `+`, `-`, `*`, `/`, `%`, `&`, `|`, `^`, `<<`, or `>>`.

Thus, we have 10 different compound assignment operators: `+=`, `-=`, `*=`, `/=`, `%=`, `&=`, `|=`, `^=`, `<<=` and `>>=`. All of them associate from right to left. Spaces separating compound operators (e.g. `+ =`) will generate error.

Compound assignment has the same effect as

```
expression1 = expression1 op expression2
```

except the lvalue `expression1` is evaluated only once. For example, `expression1 += expression2` is the same as `expression1 = expression1 + expression2`.

Assignment Rules

For both simple and compound assignment, the operands `expression1` and `expression2` must obey one of the following rules:

1. `expression1` is of qualified or unqualified arithmetic type and `expression2` is of arithmetic type.
2. `expression1` has a qualified or unqualified version of structure or union type compatible with the type of `expression2`.
3. `expression1` and `expression2` are pointers to qualified or unqualified versions of compatible types and the type pointed to by left has all qualifiers of the type pointed to by right.

4. Either `expression1` or `expression2` is a pointer to an object or incomplete type and the other is a pointer to a qualified or unqualified version of void. The type pointed to by left has all qualifiers of the type pointed to by right.
5. `expression1` is a pointer and `expression2` is a null pointer constant.

Unary Operators

Unary operators are operators that take exactly one argument.

Unary Arithmetic Operators

Unary operators `++` and `--` are the only operators in C which can be either prefix (e.g. `++k`, `--k`) or postfix (e.g. `k++`, `k--`).

When used as prefix, operators `++` and `--` (preincrement and predecrement) add or subtract one from the value of the operand *before* the evaluation. When used as suffix, operators `++` and `--` (postincrement and postdecrement) add or subtract one from the value of the operand *after* the evaluation.

Operator	Operation	Precedence
<code>+</code>	unary plus does not affect the operand	14
<code>-</code>	unary minus changes the sign of the operand	14
<code>++</code>	increment adds one to the value of the operand. Postincrement adds one to the value of the operand after it evaluates; while preincrement adds one before it evaluates	14
<code>--</code>	decrement subtracts one from the value of the operand. Postdecrement subtracts one from the value of the operand after it evaluates; while predecrement subtracts one before it evaluates	14

For example:

```
int j = 5;
j = ++k;           /* k = k + 1, j = k, which gives us j = 6, k = 6 */
```

but:

```
int j = 5;
j = k++;          /* j = k, k = k + 1, which gives us j = 5, k = 6 */
```

Unary Logical Operator

The ! (logical negation) operator produces the value 0 if its operand is true (nonzero) and the value 1 if its operand is false (0).

Operator	Operation	Precedence
!	logical negation	14

The following two expressions are equivalent:

```
!right;
right == 0;
```

Unary Bitwise Operator

The result of the ~ (bitwise negation) operator is the bitwise complement of the operand. In the binary representation of the result, every bit has the opposite value of the same bit in the binary representation of the operand.

Operator	Operation	Precedence
~	bitwise complement (unary); inverts each bit	14

Address and Indirection Operator

In the mikroC PRO for dsPIC30/33 and PIC24, address of an object in memory can be obtained by means of an unary operator &. To reach the pointed object, we use an indirection operator (*) on a pointer. See Pointers section for more details.

Operator	Operation	Precedence
*	accesses a value indirectly, through a pointer; result is the value at the address to which operand points	14
&	gives the address of its operand	14

Example:

```
int *p_to_y;    // p_to_y is defined as a pointer to an int
int y;         // y is defined as an int

p_to_y = &y;   // assigns the address of the variable y to the pointer p_to_y
*p_to_y = 3;   // causes the variable y to receive the value 3
```

Note: Besides these, sizeof and casting unary operators are supported also.

Sizeof Operator

The prefix unary operator `sizeof` returns an integer constant that represents the size of memory space (in bytes) used by its operand (determined by its type, with some exceptions).

The operator `sizeof` can take either a type identifier or an unary expression as an operand. You *cannot* use `sizeof` with expressions of function type, incomplete types, parenthesized names of such types, or with lvalue that designates a bit field object.

Sizeof Applied to Expression

If applied to expression, the size of an operand is determined without evaluating the expression (and therefore without side effects). The result of the operation will be the size of the type of the expression's result.

Sizeof Applied to Type

If applied to a type identifier, `sizeof` returns the size of the specified type. The unit for type size is `sizeof(char)` which is equivalent to one byte. The operation `sizeof(char)` gives the result 1, whether `char` is signed or `unsigned`.

Thus:

```
sizeof(char)           /* returns 1 */
sizeof(int)            /* returns 2 */
sizeof(unsigned long) /* returns 4 */
sizeof(float)         /* returns 4 */
```

When the operand is a non-parameter of array type, the result is the total number of bytes in the array (in other words, an array name is not converted to a pointer type):

```
int i, j, a[10];
...
j = sizeof(a[1]); /* j = sizeof(int) = 2 */
i = sizeof(a);    /* i = 10*sizeof(int) = 20 */

/* To get the number of elements in an array: */
int num_elem = i/j;
```

If the operand is a parameter declared as array type or function type, `sizeof` gives the size of the pointer. When applied to structures and unions, `sizeof` gives the total number of bytes, including any padding. The operator `sizeof` cannot be applied to a function.

Expressions

Expression is a sequence of operators, operands, and punctuators that specifies a computation. Formally, expressions are defined recursively: subexpressions can be nested without formal limit. However, the compiler will report an out-of-memory error if it can't compile an expression that is too complex.

In ANSI C, the *primary expressions* are: constant (also referred to as literal), identifier, and (*expression*), defined recursively.

Expressions are evaluated according to a certain conversion, grouping, associativity and precedence rules, which depends on the operators used, presence of parentheses and data types of the operands. The precedence and associativity of the operators are summarized in Operator Precedence and Associativity. The way operands and subexpressions are grouped does not necessarily specify the actual order in which they are evaluated by the mikroC PRO for dsPIC30/33 and PIC24.

Expressions can produce lvalue, rvalue, or no value. Expressions might cause side effects whether they produce a value or not.

Comma Expressions

One of the specifics of C is that it allows using of comma as a *sequence operator* to form so-called *comma expressions* or *sequences*. Comma expression is a comma-delimited list of expressions – it is formally treated as a single expression so it can be used in places where an expression is expected. The following sequence:

```
expression_1, expression_2;
```

results in the left-to-right evaluation of each *expression*, with the value and type of *expression_2* giving the result of the whole expression. Result of *expression_1* is discarded.

Binary operator comma (,) has the lowest precedence and associates from left to right, so that *a, b, c* is the same as (*a, b*), *c*. This allows writing sequences with any number of expressions:

```
expression_1, expression_2, ... expression_n;
```

which results in the left-to-right evaluation of each *expression*, with the value and type of *expression_n* giving the result of the whole expression. Results of other *expressions* are discarded, but their (possible) side-effect do occur.

For example:

```
result = ( a = 5, b /= 2, c++ );
/* returns preincremented value of variable c,
   but also initializes a, divides b by 2 and increments c */
```

```
result = ( x = 10, y = x + 3, x--, z -= x * 3 - --y );
/* returns computed value of variable z,
   and also computes x and y */
```

Note

Do not confuse comma operator (sequence operator) with comma punctuator which separates elements in a function argument list and initializer lists. To avoid ambiguity with commas in function argument and initializer lists, use parentheses. For example,

```
func(i, (j = 1, j + 4), k);
```

calls the function `func` with three arguments (i, 5, k), not four.

Statements

Statements specify a flow of control as the program executes. In the absence of specific jump and selection statements, statements are executed sequentially in the order of appearance in the source code.

Statements can be roughly divided into:

- Labeled Statements
- Expression Statements
- Selection Statements
- Iteration Statements (Loops)
- Jump Statements
- Compound Statements (Blocks)

Labeled Statements

Each statement in a program can be labeled. A label is an identifier added before the statement like this:

```
label_identifier: statement;
```

There is no special declaration of a label – it just “tags” the `statement`. `Label_identifier` has a function scope and the same label cannot be redefined within the same function.

Labels have their own namespace: label identifier can match any other identifier in the program.

A statement can be labeled for two reasons:

1. The label identifier serves as a target for the unconditional goto statement,
2. The label identifier serves as a target for the switch statement. For this purpose, only `case` and `default` labeled statements are used:

```
case constant-expression : statement  
default : statement
```

Expression Statements

Any expression followed by a semicolon forms an expression statement:

```
expression;
```

The mikroC PRO for dsPIC30/33 and PIC24 executes an expression statement by evaluating the `expression`. All side effects from this evaluation are completed before the next statement starts executing. Most of expression statements are assignment statements or function calls.

A *null statement* is a special case, consisting of a single semicolon (`;`). The null statement does nothing, and therefore is useful in situations where the mikroC PRO for dsPIC30/33 and PIC24 syntax expects a statement but the program does not need one. For example, a null statement is commonly used in “empty” loops:

```
for (; *q++ = *p++ ;); /* body of this loop is a null statement */
```

Selection Statements

Selection or flow-control statements select one of alternative courses of action by testing certain values. There are two types of selection statements:

- if
- switch

If Statement

The `if` statement is used to implement a conditional statement. The syntax of the `if` statement is:

```
if (expression) statement1 [else statement2]
```

If `expression` evaluates to true, `statement1` executes. If `expression` is false, `statement2` executes. The `expression` must evaluate to an integral value; otherwise, the condition is ill-formed. Parentheses around the `expression` are mandatory.

The `else` keyword is optional, but no statements can come between `if` and `else`.

Nested If statements

Nested `if` statements require additional attention. A general rule is that the nested conditionals are parsed starting from the innermost conditional, with each `else` bound to the nearest available `if` on its left:

```
if (expression1) statement1
else if (expression2)
    if (expression3) statement2
    else statement3      /* this belongs to: if (expression3) */
else statement4        /* this belongs to: if (expression2) */
```

Note: `#if` and `#else` preprocessor statements (directives) look similar to `if` and `else` statements, but have very different effects. They control which source file lines are compiled and which are ignored.

Switch Statement

The `switch` statement is used to pass control to a specific program branch, based on a certain condition. The syntax of the `switch` statement is:

```
switch (expression) {
    case constant-expression_1 : statement_1;
        .
        .
        .
    case constant-expression_n : statement_n;
    [default : statement;]
}
```

First, the `expression` (condition) is evaluated. The `switch` statement then compares it to all available `constant-expressions` following the keyword `case`. If a match is found, `switch` passes control to that matching `case` causing the `statement` following the match evaluates. Note that `constant-expressions` must evaluate to integer. It is not possible to have two same constant expressions evaluating to the same value.

Parentheses around `expression` are mandatory.

Upon finding a match, program flow continues normally: the following instructions will be executed in natural order regardless of the possible `case` label. If no `case` satisfies the condition, the `default` case evaluates (if the label `default` is specified).

For example, if a variable `i` has value between 1 and 3, the following switch would always return it as 4:

```
switch (i) {
    case 1: i++;
    case 2: i++;
    case 3: i++;
}
```

To avoid evaluating any other cases and relinquish control from `switch`, each `case` should be terminated with `break`.

Here is a simple example with `switch`. Suppose we have a variable `phase` with only 3 different states (0, 1, or 2) and a corresponding function (event) for each of these states. This is how we could switch the code to the appropriate routine:

```
switch (phase) {
    case 0: Lo(); break;
    case 1: Mid(); break;
    case 2: Hi(); break;
    default: Message("Invalid state!");
}
```

Nested switch

Conditional `switch` statements can be nested – labels `case` and `default` are then assigned to the innermost enclosing `switch` statement.

Iteration Statements (Loops)

Iteration statements allows to loop a set of statements. There are three forms of iteration statements in the mikroC PRO for dsPIC30/33 and PIC24:

- while
- do
- for

While Statement

The `while` keyword is used to conditionally iterate a statement. The syntax of the `while` statement is:

```
while (expression) statement
```

The `statement` executes repeatedly until the value of `expression` is false. The test takes place before `statement` is executed. Thus, if `expression` evaluates to false on the first pass, the loop does not execute. Note that parentheses around `expression` are mandatory.

Here is an example of calculating scalar product of two vectors, using the `while` statement:

```
int s = 0, i = 0;
while (i < n) {
    s += a[i] * b[i];
    i++;
}
```

Note that body of the loop can be a null statement. For example:

```
while (*q++ = *p++);
```

Do Statement

The `do` statement executes until the condition becomes false. The syntax of the `do` statement is:

```
do statement while (expression);
```

The `statement` is executed repeatedly as long as the value of `expression` remains non-zero. The `expression` is evaluated *after* each iteration, so the loop will execute `statement` at least once.

Parentheses around `expression` are mandatory.

Note that `do` is the only control structure in C which explicitly ends with semicolon (`;`). Other control structures end with `statement`, which means that they implicitly include a semicolon or closing brace.

Here is an example of calculating scalar product of two vectors, using the `do` statement:

```
s = 0; i = 0;
do {
    s += a[i] * b[i];
    i++;
} while ( i < n );
```

For Statement

The `for` statement implements an iterative loop. The syntax of the `for` statement is:

```
for ([init-expression]; [condition-expression]; [increment-expression]) statement
```

Before the first iteration of the loop, `init-expression` sets the starting variables for the loop. You cannot pass declarations in `init-expression`.

`condition-expression` is checked before the first entry into the block; `statement` is executed repeatedly until the value of `condition-expression` is false. After each iteration of the loop, `increment-expression` increments a loop counter. Consequently, `i++` is functionally the same as `++i`.

All expressions are optional. If `condition-expression` is left out, it is assumed to be always true. Thus, “empty” `for` statement is commonly used to create an endless loop in C:

```
for ( ; ; ) statement
```

The only way to break out of this loop is by means of the `break` statement.

Here is an example of calculating scalar product of two vectors, using the `for` statement:

```
for ( s = 0, i = 0; i < n; i++ ) s += a[i] * b[i];
```

There is another way to do this:

```
for ( s = 0, i = 0; i < n; s += a[i] * b[i], i++ ); /* valid, but ugly */
```

but it is considered a bad programming style. Although legal, calculating the sum *should* not be a part of the incrementing expression, because it is not in the service of loop routine. Note that null statement (`;`) is used for the loop body.

Jump Statements

The jump statement, when executed, transfers control unconditionally. There are four such statements in the mikroC PRO for dsPIC30/33 and PIC24:

- break
- continue
- goto
- return

Break and Continue Statements

Break Statement

Sometimes it is necessary to stop the loop within its body. Use the `break` statement within loops to pass control to the first statement following the innermost `switch`, `for`, `while`, or `do` block.

`Break` is commonly used in the `switch` statements to stop its execution upon the first positive match. For example:

```
switch (state) {
    case 0: Lo(); break;
    case 1: Mid(); break;
    case 2: Hi(); break;
    default: Message("Invalid state!");
}
```

Continue Statement

The `continue` statement within loops is used to “skip the cycle”. It passes control to the end of the innermost enclosing end brace belonging to a looping construct. At that point the loop continuation condition is re-evaluated. This means that `continue` demands the next iteration if the loop continuation condition is true.

Specifically, the `continue` statement within the loop will jump to the marked position as it is shown below:

<pre>while (..) { ... if (val>0) continue; ... // continue jumps here }</pre>	<pre>do { ... if (val>0) continue; ... // continue jumps here } while (..);</pre>	<pre>for (..;..;..) { ... if (val>0) continue; ... // continue jumps here }</pre>
--	--	--

Goto Statement

The `goto` statement is used for unconditional jump to a local label — for more information on labels, refer to Labeled Statements. The syntax of the `goto` statement is:

```
goto label_identifier;
```

This will transfer control to the location of a local label specified by `label_identifier`. The `label_identifier` has to be a name of the label within the same function in which the `goto` statement is. The `goto` line can come before or after the label.

`goto` is used to break out from any level of nested control structures but it cannot be used to jump *into* block while skipping that block's initializations – for example, jumping into loop's body, etc.

The use of `goto` statement is generally discouraged as practically every algorithm can be realized without it, resulting in legible structured programs. One possible application of the `goto` statement is breaking out from deeply nested control structures:

```
for (...) {  
    for (...) {  
        ...  
        if (disaster) goto Error;  
        ...  
    }  
}  
.  
.  
.  
Error: /* error handling code */
```

Return Statement

The `return` statement is used to exit from the current function back to the calling routine, optionally returning a value. The syntax is:

```
return [expression];
```

This will evaluate `expression` and return the result. Returned value will be automatically converted to the expected function type, if needed. The `expression` is optional; if omitted, the function will return a random value from memory.

Note: The statement `return` in functions of the `void` type cannot have `expression` – in fact, the `return` statement can be omitted altogether if it is the last statement in the function body.

Compound Statements (Blocks)

The compound statement, or *block*, is a list (possibly empty) of statements enclosed in matching braces { }. Syntactically, the block can be considered to be a single statement, but it also plays a role in the scoping of identifiers. An identifier declared within the block has a scope starting at the point of declaration and ending at the closing brace. Blocks can be nested to any depth up to the limits of memory.

For example, the `for` loop expects one statement in its body, so we can pass it a compound statement:

```
for (i = 0; i < n; i++ ) {
    int temp = a[i];
    a[i] = b[i];
    b[i] = temp;
}
```

Note that, unlike other statements, compound statements do not end with semicolon (;), i.e. there is never a semicolon following the closing brace.

Preprocessor

Preprocessor is an integrated text processor which prepares the source code for compiling. Preprocessor allows:

- inserting text from a specified file to a certain point in the code (see File Inclusion),
- replacing specific lexical symbols with other symbols (see Macros),
- conditional compiling which conditionally includes or omits parts of the code (see Conditional Compilation).

Note that preprocessor analyzes text at token level, not at individual character level. Preprocessor is controlled by means of preprocessor directives and preprocessor operators.

Preprocessor Directives

Any line in the source code with a leading # is taken as a *preprocessing directive* (or *control line*), unless # is within a string literal, in a character constant, or embedded in a comment. The initial # can be preceded or followed by a whitespace (excluding new lines).

A *null directive* consists of a line containing the single character #. This line is always ignored.

Preprocessor directives are usually placed at the beginning of the source code, but they can legally appear at any point in a program. The mikroC PRO for dsPIC30/33 and PIC24 preprocessor detects preprocessor directives and parses the tokens embedded in them. A directive is in effect from its declaration to the end of the program file.

Here is one commonly used directive:

```
#include <math.h>
```

For more information on including files with the `#include` directive, refer to File Inclusion.

The mikroC PRO for dsPIC30/33 and PIC24 supports standard preprocessor directives:

```
# (null directive)      #if
#define                 #ifdef
#elif                  #ifndef
#else                  #include
#endif                 #line
#error                 #undef
```

Note: For the time being only `funcall` pragma is supported.

Line Continuation with Backslash (\)

To break directive into multiple lines end the line with a backslash (\):

```
#define MACRO This directive continues to \
              the following line.
```

Macros

Macros provide a mechanism for a token replacement, prior to compilation, with or without a set of formal, function-like parameters.

Defining Macros and Macro Expansions

The `#define` directive defines a macro:

```
#define macro_identifier <token_sequence>
```

Each occurrence of `macro_identifier` in the source code following this control line will be replaced in the original position with the possibly empty `token_sequence` (there are some exceptions, which are discussed later). Such replacements are known as macro expansions. `token_sequence` is sometimes called the body of a macro. An empty token sequence results in the removal of each affected macro identifier from the source code.

No semicolon (;) is needed to terminate a preprocessor directive. Any character found in the token sequence, including semicolons, will appear in a macro expansion. `token_sequence` terminates at the first non-backslashed new line encountered. Any sequence of whitespace, including comments in the token sequence, is replaced with a single-space character.

After each individual macro expansion, a further scan is made of the newly expanded text. This allows the possibility of using nested macros: the expanded text can contain macro identifiers that are subject to replacement. However, if the macro expands into something that looks like a preprocessing directive, such directive will not be recognized by the preprocessor. Any occurrences of the macro identifier found within literal strings, character constants, or comments in the source code will not be expanded.

A macro won't be expanded during its own expansion (so `#define MACRO MACRO` won't expand indefinitely).

Here is an example:

```
/* Here are some simple macros: */
#define ERR_MSG "Out of range!"
#define EVERLOOP for( ; ; )

/* which we could use like this: */

main() {
    EVERLOOP {
        ...
        if (error) { Lcd_Out_Cp(ERR_MSG); break; }
        ...
    }
}
```

Attempting to redefine an already defined macro identifier will result in a warning unless a new definition is exactly the same token-by-token definition as the existing one. The preferred strategy when definitions might exist in other header files is as follows:

```
#ifndef BLOCK_SIZE
#define BLOCK_SIZE 512
#endif
```

The middle line is bypassed if `BLOCK_SIZE` is currently defined; if `BLOCK_SIZE` is not currently defined, the middle line is invoked to define it.

Macros with Parameters

The following syntax is used to define a macro with parameters:

```
#define macro_identifier(<arg_list>) <token_sequence>
```

Note that there can be no whitespace between `macro_identifier` and “(”. The optional `arg_list` is a sequence of identifiers separated by commas, like the argument list of a C function. Each comma-delimited identifier has the role of a formal argument or placeholder.

Such macros are called by writing

```
macro_identifier(<actual_arg_list>)
```

in the subsequent source code. The syntax is identical to that of a function call; indeed, many standard library C “functions” are implemented as macros. However, there are some important semantic differences.

The optional `actual_arg_list` must contain the same number of comma-delimited token sequences, known as actual arguments, as found in the formal `arg_list` of the `#define` line – there *must* be an actual argument for each formal argument. An error will be reported if the number of arguments in two lists is not the same.

A macro call results in two sets of replacements. First, the macro identifier and the parenthesis-enclosed arguments are replaced by the token sequence. Next, any formal arguments occurring in the token sequence are replaced by the corresponding real arguments appearing in `actual_arg_list`. Like with simple macro definitions, rescanning occurs to detect any embedded macro identifiers eligible for expansion.

Here is a simple example:

```
/* A simple macro which returns greater of its 2 arguments: */
#define _MAX(A, B) ((A) > (B)) ? (A) : (B)

/* Let's call it: */
x = _MAX(a + b, c + d);

/* Preprocessor will transform the previous line into:
x = ((a + b) > (c + d)) ? (a + b) : (c + d) */
```

It is highly recommended to put parentheses around each argument in the macro body in order to avoid possible problems with operator precedence.

Undefining Macros

The `#undef` directive is used to undefine a macro.

```
#undef macro_identifier
```

The directive `#undef` detaches any previous token sequence from `macro_identifier`; the macro definition has been forgotten, and `macro_identifier` is undefined. No macro expansion occurs within the `#undef` lines.

The state of being defined or undefined is an important property of an identifier, regardless of the actual definition. The `#ifdef` and `#ifndef` conditional directives, used to test whether any identifier is currently defined or not, offer a flexible mechanism for controlling many aspects of a compilation.

After a macro identifier has been undefined, it can be redefined with `#define`, using the same or different token sequence.

File Inclusion

The preprocessor directive `#include` pulls in *header files* (extension `.h`) into the source code. Do not rely on preprocessor to include source files (extension `.c`) — see Add/Remove Files from Project for more information.

The syntax of the `#include` directive has two formats:

```
#include <header_name>
#include "header_name"
```

The preprocessor removes the `#include` line and replaces it with the entire text of a header file at that point in the source code. The placement of `#include` can therefore influence the scope and duration of any identifiers in the included file.

The difference between these two formats lies in searching algorithm employed in trying to locate the include file.

If the `#include` directive is used with the `<header_name>` version, the search is made successively in each of the following locations, in this particular order:

1. the mikroC PRO for dsPIC30/33 and PIC24 installation folder › “include” folder
2. user’s custom search paths

The `“header_name”` version specifies a user-supplied include file; the mikroC PRO for dsPIC30/33 and PIC24 will look for the header file in the following locations, in this particular order:

1. the project folder (folder which contains the project file `.mcpds`)
2. the mikroC PRO for dsPIC30/33 and PIC24 installation folder › “include” folder
3. user’s custom search paths

Explicit Path

By placing an explicit path in `header_name`, only that directory will be searched. For example:

```
#include "C:\my_files\test.h"
```

Note

There is also a third version of the `#include` directive, rarely used, which assumes that neither `<` nor `“` appear as the first non-whitespace character following `#include`:

```
#include macro_identifier
```

It assumes that macro definition that will expand `macro_identifier` into a valid delimited header name with either `<header_name>` or `“header_name”` formats exists.

Preprocessor Operators

The `#` (pound sign) is a preprocessor directive when it occurs as the first non-whitespace character on a line. Also, `#` and `##` perform operator replacement and merging during the preprocessor scanning phase.

Operator

In C preprocessor, a character sequence enclosed by quotes is considered a token and its content is not analyzed. This means that macro names within quotes are not expanded.

If you need an actual argument (the exact sequence of characters within quotes) as a result of preprocessing, use the `#` operator in macro body. It can be placed in front of a formal macro argument in definition in order to convert the actual argument to a string after replacement.

For example, let's have macro `LCD_PRINT` for printing variable name and value on Lcd:

```
#define LCD_PRINT(val) Lcd_Out_Cp(#val ": "); \
                    Lcd_Out_Cp(IntToStr(val));
```

Now, the following code,

```
LCD_PRINT(temp)
```

will be preprocessed to this:

```
Lcd_Out_Cp("temp" ": "); Lcd_Out_Cp(IntToStr(temp));
```

Operator

Operator `##` is used for token pasting. Two tokens can be pasted(merged) together by placing `##` in between them (plus optional whitespace on either side). The preprocessor removes whitespace and `##`, combining the separate tokens into one new token. This is commonly used for constructing identifiers.

For example, see the definition of macro `SPLICE` for pasting two tokens into one identifier:

```
#define SPLICE(x,y) x ## _ ## y
```

Now, the call `SPLICE(cnt, 2)` will expand to the identifier `cnt_2`.

Note: The mikroC PRO for dsPIC30/33 and PIC24 does not support the older nonportable method of token pasting using `(1/**/r)`.

Conditional Compilation

Conditional compilation directives are typically used to make source programs easy to change and easy to compile in different execution environments. The mikroC PRO for dsPIC30/33 and PIC24 supports conditional compilation by replacing the appropriate source-code lines with a blank line.

All conditional compilation directives must be completed in the source or include file in which they have begun.

Directives `#if`, `#elif`, `#else`, and `#endif`

The conditional directives `#if`, `#elif`, `#else`, and `#endif` work very similar to the common C conditional statements. If the expression you write after `#if` has a nonzero value, the line group immediately following the `#if` directive is retained in the translation unit.

The syntax is:

```
#if constant_expression_1
<section_1>

[#elif constant_expression_2
<section_2>]
...
[#elif constant_expression_n
<section_n>]

[#else
<final_section>]

#endif
```

Each `#if` directive in a source file must be matched by a closing `#endif` directive. Any number of `#elif` directives can appear between `#if` and `#endif` directives, but at most one `#else` directive is allowed. The `#else` directive, if present, must be the last directive before `#endif`.

`sections` can be any program text that has meaning to compiler or preprocessor. The preprocessor selects a single `section` by evaluating `constant_expression` following each `#if` or `#elif` directive until it finds a true (nonzero) constant expression. The constant expressions are subject to macro expansion.

If all occurrences of constant-expression are false, or if no `#elif` directives appear, the preprocessor selects the text block after the `#else` clause. If the `#else` clause is omitted and all instances of `constant_expression` in the `#if` block are false, no `section` is selected for further processing.

Any processed section can contain further conditional clauses, nested to any depth. Each nested `#else`, `#elif`, or `#endif` directive belongs to the closest preceding the `#if` directive.

The net result of the preceding scenario is that only one code `section` (possibly empty) will be compiled.

Directives #ifdef and #ifndef

The `#ifdef` and `#ifndef` directives can be used anywhere `#if` can be used and they can test whether an identifier is currently defined or not. The line

```
#ifdef identifier
```

has exactly the same effect as `#if 1` if `identifier` is currently defined, and the same effect as `#if 0` if `identifier` is currently undefined. The other directive, `#ifndef`, tests true for the “not-defined” condition, producing the opposite results.

The syntax thereafter follows that of `#if`, `#elif`, `#else`, and `#endif`.

An identifier defined as `NULL` is considered to be defined.

CHAPTER 9

mikoC PRO for dsPIC30/33 and PIC24 Libraries

mikoC PRO for dsPIC30/33 and PIC24 provides a set of libraries which simplify the initialization and use of dsPIC30/33 and PIC24 and their modules:

Use Library manager to include mikoC PRO for dsPIC30/33 and PIC24 Libraries in you project.

Hardware Libraries

- ADC Library
- CAN Library
- CANSPI Library
- Compact Flash Library
- Enhanced CAN Library
- EEPROM Library
- Epson S1D13700 Graphic Lcd Library
- Flash Memory Library
- Graphic Lcd Library
- I²C Library
- Keypad Library
- Lcd Library
- Manchester Code Library
- Multi Media Card Library
- OneWire Library
- Peripheral Pin Select Library
- Port Expander Library
- PS/2 Library
- PWM Library
- PWM Motor Library
- RS-485 Library
- Software I²C Library
- Software SPI Library
- Software UART Library
- Sound Library
- SPI Library
- SPI Ethernet Library
- SPI Ethernet ENC24J600 Library
- SPI Graphic Lcd Library
- SPI Lcd Library
- SPI Lcd8 Library
- SPI T6963C Graphic Lcd Library
- T6963C Graphic Lcd Library
- TFT Display Library
- Touch Panel Library
- Touch Panel TFT Library
- UART Library
- USB Library

Digital Signal Processing Libraries

- FIR Filter Library
- IIR Filter Library
- FFT Library
- Bit Reverse Complex Library
- Vectors Library
- Matrices Library

Standard ANSI C Libraries

- ANSI C Ctype Library
- ANSI C Math Library
- ANSI C Stdlib Library
- ANSI C String Library

Miscellaneous Libraries

- Button Library
- Conversions Library
- PrintOut Library
- Setjmp Library
- Sprint Library
- Time Library
- Trigonometry Library
- See also Built-in Routines.

Hardware Libraries

- ADC Library
- CAN Library
- CANSPI Library
- Compact Flash Library
- DSP Libraries
- Enhanced CAN Library
- EEPROM Library
- Epson S1D13700 Graphic Lcd Library
- Flash Memory Library
- Graphic Lcd Library
- I²C Library
- Keypad Library
- Lcd Library
- Manchester Code Library
- Multi Media Card Library
- OneWire Library
- Peripheral Pin Select Library
- Port Expander Library
- PS/2 Library
- PWM Library
- PWM Motor Library
- RS-485 Library
- Software I²C Library
- Software SPI Library
- Software UART Library
- Sound Library
- SPI Library
- SPI Ethernet Library
- SPI Ethernet ENC24J600 Library
- SPI Graphic Lcd Library
- SPI Lcd Library
- SPI Lcd8 Library
- SPI T6963C Graphic Lcd Library
- T6963C Graphic Lcd Library
- TFT Display Library
- Touch Panel Library
- Touch Panel TFT Library
- UART Library
- USB Library

ADC Library

ADC (Analog to Digital Converter) module is available with a number of dsPIC30/33 and PIC24 MCU modules. ADC is an electronic circuit that converts continuous signals to discrete digital numbers. ADC Library provides you a comfortable work with the module.

Library Routines

- ADCx_Init
- ADCx_Init_Advanced
- ADCx_Get_Sample
- ADCx_Read
- ADC_Set_Active

ADCx_Init

Prototype	<code>void ADCx_Init();</code>
Description	<p>This routines configures ADC module to work with default settings.</p> <p>The internal ADC module is set to:</p> <ul style="list-style-type: none"> - single channel conversion - 10-bit conversion resolution - unsigned integer data format - auto-convert - VRef+ : AVdd, VRef- : AVss - instruction cycle clock - conversion clock : 32*Tcy - auto-sample time : 31TAD
Parameters	None.
Returns	Nothing.
Requires	<ul style="list-style-type: none"> - MCU with built-in ADC module. - ADC library routines require you to specify the module you want to use. To select the desired ADC module, simply change the letter x in the routine prototype for a number from 1 to 2.
Example	<code>ADC1_Init(); // Initialize ADC1 module with default settings</code>
Notes	- Number of ADC modules per MCU differs from chip to chip. Please, read the appropriate datasheet before utilizing this library.

ADCx_Init_Advanced

Prototype	<pre>// dsPIC30F and PIC24FJ prototype void ADC1_Init_Advanced(unsigned Reference); // dsPIC33FJ and PIC24HJ prototype void ADCx_Init_Advanced(unsigned ADCMode, unsigned Reference);</pre>														
Description	This routine configures the internal ADC module to work with user defined settings.														
Parameters	<ul style="list-style-type: none"> - ADCMode: resolution of the ADC module. - Reference: voltage reference used in ADC process. <table border="1" style="margin-left: 40px; margin-top: 10px;"> <thead> <tr> <th style="text-align: center;">Description</th> <th style="text-align: center;">Predefined library const</th> </tr> </thead> <tbody> <tr> <td colspan="2" style="text-align: center;">ADC mode:</td> </tr> <tr> <td style="text-align: center;">10-bit resolution</td> <td style="text-align: center;">_ADC_10bit</td> </tr> <tr> <td style="text-align: center;">12-bit resolution</td> <td style="text-align: center;">_ADC_12bit</td> </tr> <tr> <td colspan="2" style="text-align: center;">Voltage reference</td> </tr> <tr> <td style="text-align: center;">Internal voltage reference</td> <td style="text-align: center;">_ADC_INTERNAL_REF</td> </tr> <tr> <td style="text-align: center;">External voltage reference</td> <td style="text-align: center;">_ADC_EXTERNAL_REF</td> </tr> </tbody> </table>	Description	Predefined library const	ADC mode:		10-bit resolution	_ADC_10bit	12-bit resolution	_ADC_12bit	Voltage reference		Internal voltage reference	_ADC_INTERNAL_REF	External voltage reference	_ADC_EXTERNAL_REF
Description	Predefined library const														
ADC mode:															
10-bit resolution	_ADC_10bit														
12-bit resolution	_ADC_12bit														
Voltage reference															
Internal voltage reference	_ADC_INTERNAL_REF														
External voltage reference	_ADC_EXTERNAL_REF														
Returns	Nothing.														
Requires	<ul style="list-style-type: none"> - MCU with built-in ADC module. - ADC library routines require you to specify the module you want to use. To select the desired ADC module, simply change the letter x in the routine prototype for a number from 1 to 2. 														
Example	<pre>ADC1_Init_Advanced(_ADC_10bit, _ADC_INTERNAL_REF); // sets ADC module in 12-bit resolution mode with internal reference used</pre>														
Notes	<ul style="list-style-type: none"> - Number of ADC modules per MCU differs from chip to chip. Please, read the appropriate datasheet before utilizing this library. - Not all MCUs support advanced configuration. Please, read the appropriate datasheet before utilizing this library. 														

ADCx_Get_Sample

Prototype	<code>unsigned ADCx_Get_Sample(unsigned channel);</code>
Description	The function enables ADC module and reads the specified analog channel input.
Parameters	- <code>channel</code> represents the channel from which the analog value is to be acquired.
Returns	10-bit or 12-bit (depending on selected mode by <code>ADCx_Init_Advanced</code> or MCU) unsigned value from the specified <code>channel</code> .
Requires	<ul style="list-style-type: none"> - The MCU with built-in ADC module. - Prior to using this routine, ADC module needs to be initialized. See <code>ADCx_Init</code> and <code>ADCx_Init_Advanced</code>. - ADC library routines require you to specify the module you want to use. To select the desired ADC module, simply change the letter x in the routine prototype for a number from 1 to 2. - Before using the function, be sure to configure the appropriate TRISx bits to designate pins as inputs.
Example	<pre>unsigned adc_value; ... adc_value = ADC1_Get_Sample(10); // read analog value from ADC1 module channel 10</pre>
Notes	<ul style="list-style-type: none"> - Number of ADC modules per MCU differs from chip to chip. Please, read the appropriate datasheet before utilizing this library. - The function sets the appropriate bit in the ADPCFG registers to enable analog function of the chosen pin. - Refer to the appropriate Datasheet for channel-to-pin mapping.

ADCx_Read

Prototype	<code>unsigned ADCx_Read(unsigned channel);</code>
Description	The function initializes, enables ADC module and reads the specified analog channel input.
Parameters	- <code>channel</code> represents the channel from which the analog value is to be acquired.
Returns	10-bit or 12-bit (depending on the MCU) unsigned value from the specified <code>channel</code> .
Requires	<ul style="list-style-type: none"> - The MCU with built-in ADC module. - ADC library routines require you to specify the module you want to use. To select the desired ADC module, simply change the letter x in the routine prototype for a number from 1 to 2. - Number of ADC modules per MCU differs from chip to chip. Please, read the appropriate datasheet before utilizing this library. - Before using the function, be sure to configure the appropriate TRISx bits to designate pins as inputs.
Example	<pre>unsigned adc_value; ... adc_value = ADC1_Read(10); // read analog value from ADC1 module channel 10</pre>
Notes	<ul style="list-style-type: none"> - This is a standalone routine, so there is no need for a previous initialization of ADC module. - The function sets the appropriate bit in the ADPCFG registers to enable analog function of the chosen pin. - Refer to the appropriate Datasheet for channel-to-pin mapping.

ADC_Set_Active

Prototype	<code>void ADC_Set_Active(unsigned (*adc_gs)(unsigned));</code>
Description	Sets active ADC module.
Parameters	Parameters: - <code>adc_gs</code> : ADCx_Get_Sample handler.
Returns	Nothing.
Requires	Routine is available only for MCUs with multiple ADC modules. Used ADC module must be initialized before using this routine. See <code>ADCx_Init</code> and <code>ADCx_Init_Advanced</code> routines.
Example	<pre>// Activate ADC2 module ADC_Set_Active(ADC2_Get_Sample);</pre>
Notes	None.

Library Example

This code snippet reads analog value from the channel 1 and sends readings as a text over UART1.

Copy Code To Clipboard

```
unsigned adcRes;
char txt[6];

void main() {

    PORTB = 0x0000;
    TRISB.F1 = 1;          // set pin as input - needed for ADC to work
    ADC1_Init();
    UART1_Init(9600);

    while (1) {
        adcRes = ADC1_Get_Sample(1);
        WordToStr(adcRes, txt);
        UART1_Write_Text(txt);
        Delay_ms(50);
    }
}
```

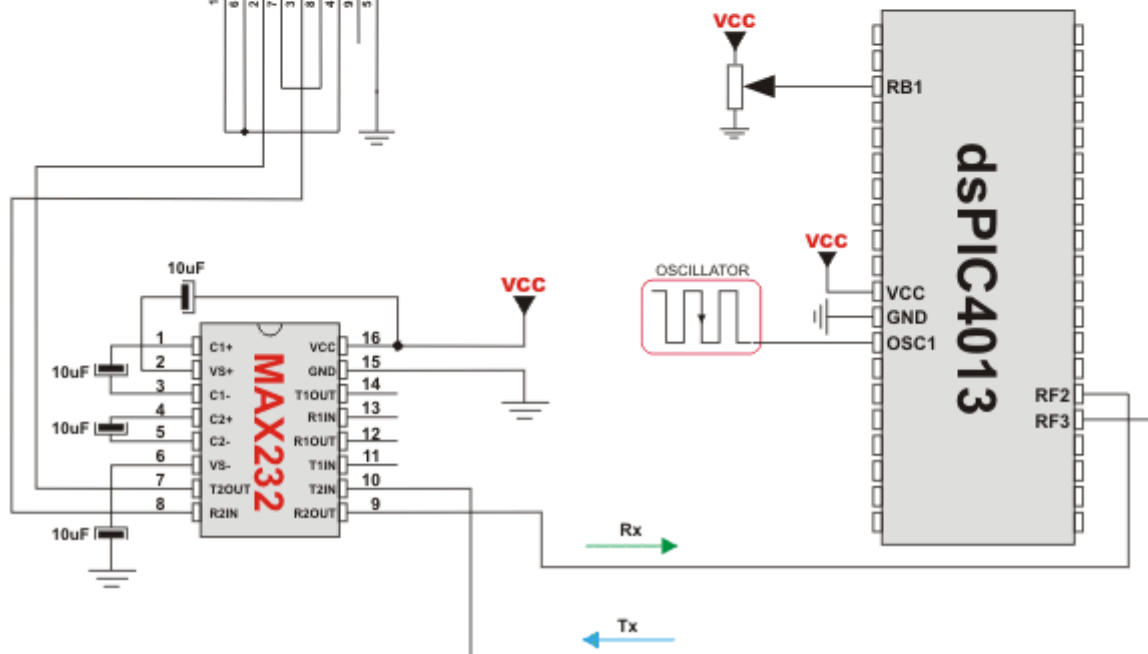
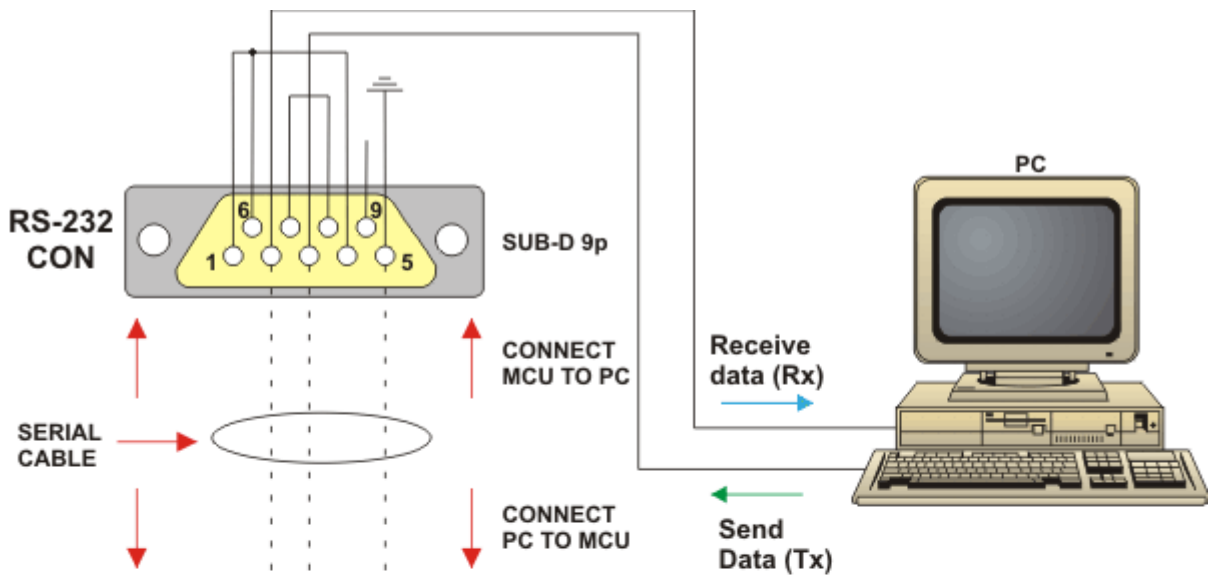

ADC HW connection

CAN Library

The mikroC PRO for dsPIC30/33 and PIC24 provides a library (driver) for working with the dsPIC30F CAN module.

The CAN is a very robust protocol that has error detection and signalization, self-checking and fault confinement. Faulty CAN data and remote frames are re-transmitted automatically, similar to the Ethernet.

Data transfer rates depend on distance. For example, 1 Mbit/s can be achieved at network lengths below 40m while 250 Kbit/s can be achieved at network lengths below 250m. The greater distance the lower maximum bitrate that can be achieved. The lowest bitrate defined by the standard is 200Kbit/s. Cables used are shielded twisted pairs.

CAN supports two message formats:

- Standard format, with 11 identifier bits and
- Extended format, with 29 identifier bits

Important:

- Consult the CAN standard about CAN bus termination resistance.
- CAN library routines require you to specify the module you want to use. To use the desired CAN module, simply change the letter **x** in the routine prototype for a number from **1** to **2**.
- Number of CAN modules per MCU differs from chip to chip. Please, read the appropriate datasheet before utilizing this library.

Library Routines

- CANxSetOperationMode
- CANxGetOperationMode
- CANxInitialize
- CANxSetBaudRate
- CANxSetMask
- CANxSetFilter
- CANxRead
- CANxWrite

CANxSetOperationMode

Prototype	<code>void CANxSetOperationMode(unsigned int mode, unsigned int WAIT);</code>
Description	Sets the CAN module to requested mode.
Parameters	<ul style="list-style-type: none"> - <code>mode</code>: CAN module operation mode. Valid values: <code>CAN_OP_MODE</code> constants. See <code>CAN_OP_MODE</code> constants. - <code>WAIT</code>: CAN mode switching verification request. If <code>WAIT == 0</code>, the call is non-blocking. The function does not verify if the CAN module is switched to requested mode or not. Caller must use <code>CANxGetOperationMode</code> to verify correct operation mode before performing mode specific operation. If <code>WAIT != 0</code>, the call is blocking – the function won't "return" until the requested mode is set.
Returns	Nothing.
Requires	<p>MCU with the CAN module.</p> <p>MCU must be connected to the CAN transceiver (MCP2551 or similar) which is connected to the CAN bus.</p>
Example	<pre>// set the CAN1 module into configuration mode (wait inside CAN1SetOperationMode until this mode is set) CAN1SetOperationMode(_CAN_MODE_CONFIG, 0xFF);</pre>
Notes	<ul style="list-style-type: none"> - CAN library routine require you to specify the module you want to use. To use the desired CAN module, simply change the letter x in the routine prototype for a number from 1 to 2. - Number of CAN modules per MCU differs from chip to chip. Please, read the appropriate datasheet before utilizing this library.

CANxGetOperationMode

Prototype	<code>unsigned int CANxGetOperationMode();</code>
Description	The function returns current operation mode of the CAN module. See <code>CAN_OP_MODE</code> constants or device datasheet for operation mode codes.
Parameters	None.
Returns	Current operation mode.
Requires	<p>MCU with the CAN module.</p> <p>MCU must be connected to the CAN transceiver (MCP2551 or similar) which is connected to the CAN bus.</p>
Example	<pre>// check whether the CAN1 module is in Normal mode and if it is then do something. if (CAN1GetOperationMode() == _CAN_MODE_NORMAL) { ... }</pre>
Notes	<ul style="list-style-type: none"> - CAN library routine require you to specify the module you want to use. To use the desired CAN module, simply change the letter x in the routine prototype for a number from 1 to 2. - Number of CAN modules per MCU differs from chip to chip. Please, read the appropriate datasheet before utilizing this library.

CANxInitialize

Prototype	<code>void CANxInitialize(unsigned int SJW, unsigned int BRP, unsigned int PHSEG1, unsigned int PHSEG2, unsigned int PROPSEG, unsigned int CAN_CONFIG_FLAGS);</code>
Description	<p>Initializes the CAN module.</p> <p>The internal dsPIC30F CAN module is set to:</p> <ul style="list-style-type: none"> - Disable CAN capture - Continue CAN operation in Idle mode - Do not abort pending transmissions - Fcan clock : 4*Tcy (Fosc) - Baud rate is set according to given parameters - CAN mode is set to Normal - Filter and mask registers IDs are set to zero - Filter and mask message frame type is set according to <code>CAN_CONFIG_FLAGS</code> value <p><code>SAM</code>, <code>SEG2PHTS</code>, <code>WAKFIL</code> and <code>DBEN</code> bits are set according to <code>CAN_CONFIG_FLAGS</code> value.</p>
Parameters	<ul style="list-style-type: none"> - <code>SJW</code> as defined in MCU's datasheet (CAN Module) - <code>BRP</code> as defined in MCU's datasheet (CAN Module) - <code>PHSEG1</code> as defined in MCU's datasheet (CAN Module) - <code>PHSEG2</code> as defined in MCU's datasheet (CAN Module) - <code>PROPSEG</code> as defined in MCU's datasheet (CAN Module) - <code>CAN_CONFIG_FLAGS</code> is formed from predefined constants. See <code>CAN_CONFIG_FLAGS</code> constants.
Returns	Nothing.
Requires	<p>MCU with the CAN module.</p> <p>MCU must be connected to the CAN transceiver (MCP2551 or similar) which is connected to the CAN bus.</p>
Example	<pre>// initialize the CAN1 module with appropriate baud rate and message // acceptance flags along with the sampling rules unsigned int can_config_flags; ... can_config_flags = _CAN_CONFIG_SAMPLE_THRICE & // Form value to be used _CAN_CONFIG_PHSEG2_PRG_ON & // with CAN1Initialize _CAN_CONFIG_STD_MSG & _CAN_CONFIG_DBL_BUFFER_ON & _CAN_CONFIG_MATCH_MSG_TYPE & _CAN_CONFIG_LINE_FILTER_OFF; CAN1Initialize(1,3,3,3,1,can_config_flags); // initialize the CAN1 module</pre>
Notes	<ul style="list-style-type: none"> - CAN mode NORMAL will be set on exit. - CAN library routine require you to specify the module you want to use. To use the desired CAN module, simply change the letter x in the routine prototype for a number from 1 to 2. - Number of CAN modules per MCU differs from chip to chip. Please, read the appropriate datasheet before utilizing this library.

CANxSetBaudRate

Prototype	<code>void CANxSetBaudRate(unsigned int SJW, unsigned int BRP, unsigned int PHSEG1, unsigned int PHSEG2, unsigned int PROPSEG, unsigned int CAN_CONFIG_FLAGS);</code>
Description	<p>Sets CAN baud rate. Due to complexity of the CAN protocol, you can not simply force a bps value. Instead, use this function when CAN is in Config mode. Refer to datasheet for details.</p> <p><code>SAM</code>, <code>SEG2PHTS</code> and <code>WAKFIL</code> bits are set according to <code>CAN_CONFIG_FLAGS</code> value. Refer to datasheet for details.</p>
Parameters	<ul style="list-style-type: none"> - <code>SJW</code> as defined in MCU's datasheet (CAN Module) - <code>BRP</code> as defined in MCU's datasheet (CAN Module) - <code>PHSEG1</code> as defined in MCU's datasheet (CAN Module) - <code>PHSEG2</code> as defined in MCU's datasheet (CAN Module) - <code>PROPSEG</code> as defined in MCU's datasheet (CAN Module) - <code>CAN_CONFIG_FLAGS</code> is formed from predefined constants. See <code>CAN_CONFIG_FLAGS</code> constants.
Returns	Nothing.
Requires	<p>MCU with the CAN module.</p> <p>MCU must be connected to the CAN transceiver (MCP2551 or similar) which is connected to the CAN bus.</p> <p>CAN must be in Config mode, otherwise the function will be ignored. See <code>CANxSetOperationMode</code>.</p>
Example	<pre>// set required baud rate and sampling rules unsigned int can_config_flags; ... CAN1SetOperationMode(_CAN_MODE_CONFIG,0xFF); // set CONFIGURATION mode (CAN1 module must be in config mode for baud rate settings) can_config_flags = _CAN_CONFIG_SAMPLE_THRICE & // Form value to be used _CAN_CONFIG_PHSEG2_PRG_ON & // with CAN1SetBaudRate _CAN_CONFIG_STD_MSG & _CAN_CONFIG_DBL_BUFFER_ON & _CAN_CONFIG_MATCH_MSG_TYPE & _CAN_CONFIG_LINE_FILTER_OFF; CAN1SetBaudRate(1,3,3,3,1,can_config_flags); // set the CAN1 module baud rate</pre>
Notes	<ul style="list-style-type: none"> - CAN library routine require you to specify the module you want to use. To use the desired CAN module, simply change the letter <code>x</code> in the routine prototype for a number from <code>1</code> to <code>2</code>. - Number of CAN modules per MCU differs from chip to chip. Please, read the appropriate datasheet before utilizing this library.

CANxSetMask

Prototype	<code>void CANxSetMask(unsigned int CAN_MASK, long val, unsigned int CAN_CONFIG_FLAGS);</code>
Description	Function sets mask for advanced filtering of messages. Given <code>value</code> is bit adjusted to appropriate buffer mask registers.
Parameters	<ul style="list-style-type: none"> - <code>CAN_MASK</code>: CAN module mask number. Valid values: <code>CAN_MASK</code> constants. See <code>CAN_MASK</code> constants. - <code>val</code>: mask register value. This value is bit-adjusted to appropriate buffer mask registers - <code>CAN_CONFIG_FLAGS</code>: selects type of message to filter. Valid values: <ul style="list-style-type: none"> - <code>_CAN_CONFIG_ALL_VALID_MSG,</code> - <code>_CAN_CONFIG_MATCH_MSG_TYPE & _CAN_CONFIG_STD_MSG,</code> - <code>_CAN_CONFIG_MATCH_MSG_TYPE & _CAN_CONFIG_XTD_MSG.</code> See <code>CAN_CONFIG_FLAGS</code> constants.
Returns	Nothing.
Requires	MCU with the CAN module. MCU must be connected to the CAN transceiver (MCP2551 or similar) which is connected to the CAN bus. CAN must be in Config mode, otherwise the function will be ignored. See <code>CANxSetOperationMode</code> .
Example	<pre>// set appropriate filter mask and message type value CAN1SetOperationMode(_CAN_MODE_CONFIG,0xFF); // set CONFIGURATION mode (CAN1 module must be in config mode for mask settings) // Set all B1 mask bits to 1 (all filtered bits are relevant): // Note that -1 is just a cheaper way to write 0xFFFFFFFF. // Complement will do the trick and fill it up with ones. CAN1SetMask(_CAN_MASK_B1, -1, _CAN_CONFIG_MATCH_MSG_TYPE & _CAN_CONFIG_XTD_ MSG);</pre>
Notes	<ul style="list-style-type: none"> - CAN library routine require you to specify the module you want to use. To use the desired CAN module, simply change the letter <code>x</code> in the routine prototype for a number from 1 to 2. - Number of CAN modules per MCU differs from chip to chip. Please, read the appropriate datasheet before utilizing this library.

CANxSetFilter

Prototype	<code>void CANxSetFilter(unsigned int CAN_FILTER, long val, unsigned int CAN_CONFIG_FLAGS);</code>
Description	Function sets message filter. Given <code>value</code> is bit adjusted to appropriate buffer mask registers.
Parameters	<ul style="list-style-type: none"> - <code>CAN_FILTER</code>: CAN module filter number. Valid values: <code>CAN_FILTER</code> constants. See <code>CAN_FILTER</code> constants. - <code>val</code>: filter register value. This value is bit-adjusted to appropriate filter registers - <code>CAN_CONFIG_FLAGS</code>: selects type of message to filter. Valid values: <code>_CAN_CONFIG_STD_MSG</code> and <code>_CAN_CONFIG_XTD_MSG</code>. See <code>CAN_CONFIG_FLAGS</code> constants.
Returns	Nothing.
Requires	<p>MCU with the CAN module.</p> <p>MCU must be connected to the CAN transceiver (MCP2551 or similar) which is connected to the CAN bus.</p> <p>CAN must be in Config mode, otherwise the function will be ignored. See <code>CANxSetOperationMode</code>.</p>
Example	<pre><i>// set appropriate filter value and message type</i> CAN1SetOperationMode(_CAN_MODE_CONFIG,0xFF); <i>// set</i> <i>CONFIGURATION mode (CAN1 module must be in config mode for filter settings)</i> <i>// Set id of filter B1_F1 to 3</i> CAN1SetFilter(_CAN_FILTER_B1_F1, 3, _CAN_CONFIG_XTD_MSG);</pre>
Notes	<ul style="list-style-type: none"> - CAN library routine require you to specify the module you want to use. To use the desired CAN module, simply change the letter <code>x</code> in the routine prototype for a number from <code>1</code> to <code>2</code>. - Number of CAN modules per MCU differs from chip to chip. Please, read the appropriate datasheet before utilizing this library.

CANxRead

Prototype	<code>unsigned int CANxRead(unsigned long *id, char *data_, unsigned int *dataLen, unsigned int *CAN_RX_MSG_FLAGS);</code>
Description	<p>If at least one full Receive Buffer is found, it will be processed in the following way :</p> <ul style="list-style-type: none"> - Message ID is retrieved and stored to location pointed by <code>id</code> pointer - Message data is retrieved and stored to array pointed by <code>data</code> pointer - Message length is retrieved and stored to location pointed by <code>dataLen</code> pointer - Message flags are retrieved and stored to location pointed by <code>CAN_RX_MSG_FLAGS</code> pointer
Parameters	<ul style="list-style-type: none"> - <code>id</code>: message identifier address - <code>data</code>: an array of bytes up to 8 bytes in length - <code>dataLen</code>: data length address - <code>CAN_RX_MSG_FLAGS</code>: message flags address. For message receive flags format refer to <code>CAN_RX_MSG_FLAGS</code> constants. See <code>CAN_RX_MSG_FLAGS</code> constants.
Returns	<ul style="list-style-type: none"> - <code>0</code> if nothing is received - <code>0xFFFF</code> if one of the Receive Buffers is full (message received)
Requires	<p>MCU with the CAN module. MCU must be connected to the CAN transceiver (MCP2551 or similar) which is connected to the CAN bus. CAN must be in Config mode, otherwise the function will be ignored. See <code>CANxSetOperationMode</code>.</p>
Example	<pre><code>// check the CAN1 module for received messages. If any was received do something. unsigned int msg_rcvd, rx_flags, data_len; char data[8]; unsigned long msg_id; ... CAN1SetOperationMode(_CAN_MODE_NORMAL,0xFF); // set NORMAL mode (CAN1 module must be in mode in which receive is possible) ... rx_flags = 0; // clear message flags if (msg_rcvd = CAN1Read(&msg_id, data, &data_len, &rx_flags)) { ... }</code></pre>
Notes	<ul style="list-style-type: none"> - CAN library routine require you to specify the module you want to use. To use the desired CAN module, simply change the letter x in the routine prototype for a number from 1 to 2. - Number of CAN modules per MCU differs from chip to chip. Please, read the appropriate datasheet before utilizing this library.

CANxWrite

Prototype	<code>unsigned int CANxWrite(long id, char *data_, unsigned int DataLen, unsigned int CAN_TX_MSG_FLAGS);</code>
Description	If at least one empty Transmit Buffer is found, the function sends message in the queue for transmission.
Parameters	<ul style="list-style-type: none"> - <code>id</code>: CAN message identifier. Valid values: 11 or 29 bit values, depending on message type (standard or extended) - <code>data</code>: data to be sent - <code>dataLen</code>: data length. Valid values: 0..8 - <code>CAN_RX_MSG_FLAGS</code>: message flags. Valid values: <code>CAN_TX_MSG_FLAGS</code> constants. See <code>CAN_TX_MSG_FLAGS</code> constants.
Returns	<ul style="list-style-type: none"> - 0 if all Transmit Buffers are busy - 0xFFFF if at least one Transmit Buffer is available
Requires	<p>MCU with the CAN module.</p> <p>MCU must be connected to the CAN transceiver (MCP2551 or similar) which is connected to the CAN bus.</p> <p>CAN must be in Config mode, otherwise the function will be ignored. See <code>CANxSetOperationMode</code>.</p>
Example	<pre>// send message extended CAN message with appropriate ID and data unsigned int tx_flags; char data[8]; unsigned long msg_id; ... CAN1SetOperationMode(_CAN_MODE_NORMAL,0xFF); // set NORMAL mode (CAN1 must be in mode in which transmission is possible) tx_flags = _CAN_TX_PRIORITY_0 & _CAN_TX_XTD_FRAME & _CAN_TX_NO_RTR_FRAME; // set message flags CAN1Write(msg_id, data, 1, tx_flags);</pre>
Notes	<ul style="list-style-type: none"> - CAN library routine require you to specify the module you want to use. To use the desired CAN module, simply change the letter <code>x</code> in the routine prototype for a number from <code>1</code> to <code>2</code>. - Number of CAN modules per MCU differs from chip to chip. Please, read the appropriate datasheet before utilizing this library.

CAN Constants

There is a number of constants predefined in CAN library. To be able to use the library effectively, you need to be familiar with these. You might want to check the example at the end of the chapter.

CAN_OP_MODE Constants

`CAN_OP_MODE` constants define CAN operation mode. Function `CANxSetOperationMode` expects one of these as its argument:

Copy Code To Clipboard

```
const unsigned int
    _CAN_MODE_BITS      = 0xE0,    // Use this to access opmode bits
    _CAN_MODE_NORMAL    = 0x00,
    _CAN_MODE_SLEEP     = 0x20,
    _CAN_MODE_LOOP      = 0x40,
    _CAN_MODE_LISTEN    = 0x60,
    _CAN_MODE_CONFIG    = 0x80;
```

CAN_CONFIG_FLAGS Constants

`CAN_CONFIG_FLAGS` constants define flags related to CAN module configuration. Functions `CANxInitialize` and `CANxSetBaudRate` expect one of these (or a bitwise combination) as their argument:

Copy Code To Clipboard

```
const unsigned int
    _CAN_CONFIG_DEFAULT      = 0xFF,    // 11111111

    _CAN_CONFIG_PHSEG2_PRG_BIT = 0x01,
    _CAN_CONFIG_PHSEG2_PRG_ON  = 0xFF,    // XXXXXXX1
    _CAN_CONFIG_PHSEG2_PRG_OFF = 0xFE,    // XXXXXXX0

    _CAN_CONFIG_LINE_FILTER_BIT = 0x02,
    _CAN_CONFIG_LINE_FILTER_ON  = 0xFF,    // XXXXXX1X
    _CAN_CONFIG_LINE_FILTER_OFF = 0xFD,    // XXXXXX0X

    _CAN_CONFIG_SAMPLE_BIT     = 0x04,
    _CAN_CONFIG_SAMPLE_ONCE    = 0xFF,    // XXXXX1XX
    _CAN_CONFIG_SAMPLE_THRICE  = 0xFB,    // XXXXX0XX

    _CAN_CONFIG_MSG_TYPE_BIT   = 0x08,
    _CAN_CONFIG_STD_MSG        = 0xFF,    // XXXX1XXX
    _CAN_CONFIG_XTD_MSG        = 0xF7,    // XXXX0XXX

    _CAN_CONFIG_DBL_BUFFER_BIT = 0x10,
    _CAN_CONFIG_DBL_BUFFER_ON  = 0xFF,    // XXX1XXXX
    _CAN_CONFIG_DBL_BUFFER_OFF = 0xEF,    // XXX0XXXX
```

```

_CAN_CONFIG_MSG_BITS           = 0x60,
_CAN_CONFIG_ALL_MSG           = 0xFF,    // X11XXXXX
_CAN_CONFIG_VALID_XTD_MSG     = 0xDF,    // X10XXXXX
_CAN_CONFIG_VALID_STD_MSG     = 0xBF,    // X01XXXXX
_CAN_CONFIG_ALL_VALID_MSG     = 0x9F;    // X00XXXXX

```

You may use bitwise AND (&) to form config byte out of these values. For example:

Copy Code To Clipboard

```

init = _CAN_CONFIG_SAMPLE_THRICE &
       _CAN_CONFIG_PHSEG2_PRG_ON &
       _CAN_CONFIG_STD_MSG &
       _CAN_CONFIG_DBL_BUFFER_ON &
       _CAN_CONFIG_VALID_XTD_MSG &
       _CAN_CONFIG_LINE_FILTER_OFF;
...
CANInitialize(1, 1, 3, 3, 1, init); // initialize CAN

```

CAN_TX_MSG_FLAGS Constants

CAN_TX_MSG_FLAGS are flags related to transmission of a CAN message:

Copy Code To Clipboard

```

const unsigned int
_CAN_TX_PRIORITY_BITS = 0x03,
_CAN_TX_PRIORITY_0    = 0xFC,    // XXXXXX00
_CAN_TX_PRIORITY_1    = 0xFD,    // XXXXXX01
_CAN_TX_PRIORITY_2    = 0xFE,    // XXXXXX10
_CAN_TX_PRIORITY_3    = 0xFF,    // XXXXXX11

_CAN_TX_FRAME_BIT     = 0x08,
_CAN_TX_STD_FRAME     = 0xFF,    // XXXXX1XX
_CAN_TX_XTD_FRAME     = 0xF7,    // XXXXX0XX

_CAN_TX_RTR_BIT       = 0x40,
_CAN_TX_NO_RTR_FRAME = 0xFF,    // X1XXXXXX
_CAN_TX_RTR_FRAME     = 0xBF;    // X0XXXXXX

```

You may use bitwise AND (&) to adjust the appropriate flags. For example:

Copy Code To Clipboard

```

// form value to be used with CANSendMessage:
send_config = _CAN_TX_PRIORITY_0 &
              _CAN_TX_XTD_FRAME &
              _CAN_TX_NO_RTR_FRAME;
...
CANSendMessage(id, data, 1, send_config);

```

CAN_RX_MSG_FLAGS Constants

`CAN_RX_MSG_FLAGS` are flags related to reception of CAN message. If a particular bit is set; corresponding meaning is TRUE or else it will be FALSE.

Copy Code To Clipboard

```
const unsigned int
    _CAN_RX_FILTER_BITS = 0x07, // Use this to access filter bits
    _CAN_RX_FILTER_1   = 0x00,
    _CAN_RX_FILTER_2   = 0x01,
    _CAN_RX_FILTER_3   = 0x02,
    _CAN_RX_FILTER_4   = 0x03,
    _CAN_RX_FILTER_5   = 0x04,
    _CAN_RX_FILTER_6   = 0x05,
    _CAN_RX_OVERFLOW   = 0x08, // Set if Overflowed else cleared
    _CAN_RX_INVALID_MSG = 0x10, // Set if invalid else cleared
    _CAN_RX_XTD_FRAME  = 0x20, // Set if XTD message else cleared
    _CAN_RX_RTR_FRAME  = 0x40, // Set if RTR message else cleared
    _CAN_RX_DBL_BUFFERED = 0x80; // Set if this message was hardware double-buffered
```

You may use bitwise AND (&) to adjust the appropriate flags. For example:

Copy Code To Clipboard

```
if (MsgFlag & _CAN_RX_OVERFLOW != 0) {
    ...
    // Receiver overflow has occurred.
    // We have lost our previous message.
}
```

CAN_MASK Constants

`CAN_MASK` constants define mask codes. Function `CANxSetMask` expects one of these as its argument:

Copy Code To Clipboard

```
const unsigned int
    _CAN_MASK_B1 = 0,
    _CAN_MASK_B2 = 1;
```

CAN_FILTER Constants

`CAN_FILTER` constants define filter codes. Function `CANxSetFilter` expects one of these as its argument:

Copy Code To Clipboard

```
const unsigned int
    _CAN_FILTER_B1_F1 = 0,
    _CAN_FILTER_B1_F2 = 1,
    _CAN_FILTER_B2_F1 = 2,
    _CAN_FILTER_B2_F2 = 3,
    _CAN_FILTER_B2_F3 = 4,
    _CAN_FILTER_B2_F4 = 5;
```

Library Example

The example demonstrates CAN protocol. The 1st node initiates the communication with the 2nd node by sending some data to its address. The 2nd node responds by sending back the data incremented by 1. The 1st node then does the same and sends incremented data back to the 2nd node, etc.

Code for the first CAN node:

Copy Code To Clipboard

```
unsigned int Can_Init_Flags, Can_Send_Flags, Can_Rcv_Flags; // can flags
unsigned int Rx_Data_Len; // received data length in
bytes
char RxTx_Data[8]; // can rx/tx data buffer
char Msg_Rcvd; // reception flag
unsigned long Tx_ID, Rx_ID; // can rx and tx ID

void main() {

    ADPCFG = 0xFFFF;
    PORTB = 0;
    TRISB = 0;

    Can_Init_Flags = 0; //
    Can_Send_Flags = 0; // clear flags
    Can_Rcv_Flags = 0; //

    Can_Send_Flags = _CAN_TX_PRIORITY_0 & // Form value to be used
                    _CAN_TX_XTD_FRAME & // with CAN2Write
                    _CAN_TX_NO_RTR_FRAME;

    Can_Init_Flags = _CAN_CONFIG_SAMPLE_THRICE & // Form value to be used
                    _CAN_CONFIG_PHSEG2_PRG_ON & // with CAN2Initialize
                    _CAN_CONFIG_XTD_MSG &
                    _CAN_CONFIG_DBL_BUFFER_ON &
                    _CAN_CONFIG_MATCH_MSG_TYPE &
                    _CAN_CONFIG_LINE_FILTER_OFF;
```

```
RxTx_Data[0] = 9; // set initial data to be sent
CAN2Initialize(1,3,3,3,1,Can_Init_Flags); // initialize CAN2

CAN2SetOperationMode(_CAN_MODE_CONFIG,0xFF); // set CONFIGURATION mode

CAN2SetMask(_CAN_MASK_B1,-1,_CAN_CONFIG_MATCH_MSG_TYPE & _CAN_CONFIG_XTD_MSG); //
set all mask1 bits to ones
CAN2SetMask(_CAN_MASK_B2,-1,_CAN_CONFIG_MATCH_MSG_TYPE & _CAN_CONFIG_XTD_MSG); //
set all mask2 bits to ones
CAN2SetFilter(_CAN_FILTER_B2_F3,3,_CAN_CONFIG_XTD_MSG); // set
id of filter B1_F1 to 3

CAN2SetOperationMode(_CAN_MODE_NORMAL,0xFF); // set
NORMAL mode

Tx_ID = 12111; // set
transmit ID

CAN2Write(Tx_ID, RxTx_Data, 1, Can_Send_Flags); // send
initial message

while(1) { //
endless loop
    Msg_Rcvd = CAN2Read(&Rx_ID , RxTx_Data , &Rx_Data_Len, &Can_Rcv_Flags); // receive
message
    if ((Rx_ID == 3u) && Msg_Rcvd) { // if
message received check id
        PORTB = RxTx_Data[0]; // id
correct, output data at PORTB
        RxTx_Data[0]++; // increment
received data
        Delay_ms(10);
        CAN2Write(Tx_ID, RxTx_Data, 1, Can_Send_Flags); // send
incremented data back
    }
}
```

Code for the second CAN node:

```

Copy Code To Clipboard
unsigned int Can_Init_Flags, Can_Send_Flags, Can_Rcv_Flags; // can flags
unsigned int Rx_Data_Len; // received data length in
bytes
char RxTx_Data[8]; // can rx/tx data buffer
char Msg_Rcvd; // reception flag
unsigned long Tx_ID, Rx_ID; // can rx and tx ID

void main() {

    ADPCFG = 0xFFFF;
    PORTB = 0;
    TRISB = 0;

    Can_Init_Flags = 0; //
    Can_Send_Flags = 0; // clear flags
    Can_Rcv_Flags = 0; //

    Can_Send_Flags = _CAN_TX_PRIORITY_0 & // Form value to be used
                     _CAN_TX_XTD_FRAME & // with CAN2Write
                     _CAN_TX_NO_RTR_FRAME;

    Can_Init_Flags = _CAN_CONFIG_SAMPLE_THRICE & // Form value to be used
                     _CAN_CONFIG_PHSEG2_PRG_ON & // with CAN2Initialize
                     _CAN_CONFIG_XTD_MSG &
                     _CAN_CONFIG_DBL_BUFFER_ON &
                     _CAN_CONFIG_MATCH_MSG_TYPE &
                     _CAN_CONFIG_LINE_FILTER_OFF;

    CAN2Initialize(1,3,3,3,1,Can_Init_Flags); // initialize CAN2

    CAN2SetOperationMode(_CAN_MODE_CONFIG,0xFF); // set CONFIGURATION mode

    CAN2SetMask(_CAN_MASK_B1,-1,_CAN_CONFIG_MATCH_MSG_TYPE & _CAN_CONFIG_XTD_MSG); //
set all mask1 bits to ones
    CAN2SetMask(_CAN_MASK_B2,-1,_CAN_CONFIG_MATCH_MSG_TYPE & _CAN_CONFIG_XTD_MSG); //
set all mask2 bits to ones
    CAN2SetFilter(_CAN_FILTER_B1_F1,12111,_CAN_CONFIG_XTD_MSG); // set
id of filter B1_F1 to 12111

    CAN2SetOperationMode(_CAN_MODE_NORMAL,0xFF); // set NORMAL mode

    Tx_ID = 3; // set tx ID

    while(1) { // endless loop
        Msg_Rcvd = CAN2Read(&Rx_ID , RxTx_Data , &Rx_Data_Len, &Can_Rcv_Flags); // receive
message
        if ((Rx_ID == 12111u) && Msg_Rcvd) { // if message received check id
            PORTB = RxTx_Data[0]; // id correct, output data at PORTB
            RxTx_Data[0]++; // increment received data
            CAN2Write(Tx_ID, RxTx_Data, 1, Can_Send_Flags); // send incremented data back
        }
    }
}

```

HW Connection

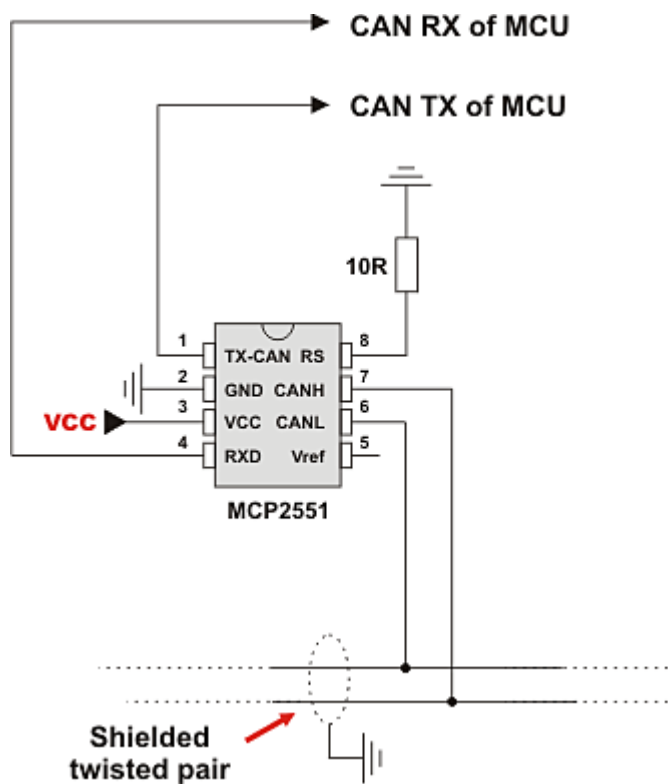

Example of interfacing CAN transceiver with MCU and CAN bus

CANSPI Library

The SPI module is available with a number of the dsPIC30/33 and PIC24 MCUs. The mikroC PRO for dsPIC30/33 and PIC24 provides a library (driver) for working with mikroElektronika's CANSPI Add-on boards (with MCP2515 or MCP2510) via SPI interface.

In the mikroC PRO for dsPIC30/33 and PIC24, each routine of the CAN library has its own CANSPI counterpart with identical syntax. For more information on Controller Area Network, consult the CAN Library. Note that an effective communication speed depends on SPI and certainly is slower than "real" CAN.

Important :

- Consult the CAN standard about CAN bus termination resistance.
- An effective CANSPI communication speed depends on SPI and certainly is slower than "real" CAN.
- The library uses the SPI module for communication. User must initialize appropriate SPI module before using the CANSPI Library.
- For MCUs with multiple SPI modules it is possible to initialize both of them and then switch by using the `SPI_Set_Active` routine.
- Number of SPI modules per MCU differs from chip to chip. Please, read the appropriate datasheet before utilizing this library.

Library Dependency Tree



External dependencies of CANSPI Library

The following variables must be defined in all projects using CANSPI Library:	Description :	Example :
<code>extern sfr sbit CanSpi_CS;</code>	Chip Select line.	<code>sbit CanSpi_CS at RFO_bit;</code>
<code>extern sfr sbit CanSpi_Rst;</code>	Reset line.	<code>sbit CanSpi_Rst at RF1_bit;</code>
<code>extern sfr sbit CanSpi_CS_Direction;</code>	Direction of the Chip Select pin.	<code>sbit CanSpi_CS_Direction at TRISF0_bit;</code>
<code>extern sfr sbit CanSpi_Rst_Direction;</code>	Direction of the Reset pin.	<code>sbit CanSpi_Rst_Direction at TRISF1_bit;</code>

Library Routines

- CANSPISetOperationMode
- CANSPIGetOperationMode
- CANSPIInitialize
- CANSPISetBaudRate
- CANSPISetMask
- CANSPISetFilter
- CANSPIRead
- CANSPIWrite

CANSPISetOperationMode

Prototype	<code>void CANSPISetOperationMode(char mode, char WAIT);</code>
Description	Sets the CANSPI module to requested mode.
Parameters	<p><code>mode</code>: CANSPI module operation mode. Valid values: <code>CANSPI_OP_MODE</code> constants. See <code>CANSPI_OP_MODE</code> constants.</p> <p><code>WAIT</code>: CANSPI mode switching verification request. If <code>WAIT == 0</code>, the call is non-blocking. The function does not verify if the CANSPI module is switched to requested mode or not. Caller must use <code>CANSPIGetOperationMode</code> to verify correct operation mode before performing mode specific operation. If <code>WAIT != 0</code>, the call is blocking – the function won't "return" until the requested mode is set.</p>
Returns	Nothing.
Requires	<p>The CANSPI routines are supported only by MCUs with the SPI module.</p> <p>MCU has to be properly connected to mikroElektronika's CANSPI Extra Board or similar hardware. See connection example at the bottom of this page.</p>
Example	<pre>// set the CANSPI module into configuration mode (wait inside CANSPISetOperationMode until this mode is set) CANSPISetOperationMode(_CANSPI_MODE_CONFIG, 0xFF);</pre>
Notes	None.

CANSPIGetOperationMode

Prototype	<code>char CANSPIGetOperationMode();</code>
Description	The function returns current operation mode of the CANSPI module. Check <code>CANSPI_OP_MODE</code> constants or device datasheet for operation mode codes.
Parameters	None.
Returns	Current operation mode.
Requires	The CANSPI routines are supported only by MCUs with the SPI module. MCU has to be properly connected to mikroElektronika's CANSPI Extra Board or similar hardware. See connection example at the bottom of this page.
Example	<pre>// check whether the CANSPI module is in Normal mode and if it is do something. if (CANSPIGetOperationMode() == _CANSPI_MODE_NORMAL) { ... }</pre>
Notes	None.

CANSPIInitialize

Prototype	<code>void CANSPIInitialize(char SJW, char BRP, char PHSEG1, char PHSEG2, char PROPSEG, char CANSPI_CONFIG_FLAGS);</code>
Description	<p>Initializes the CANSPI module.</p> <p>Stand-Alone CAN controller in the CANSPI module is set to:</p> <ul style="list-style-type: none"> - Disable CAN capture - Continue CAN operation in Idle mode - Do not abort pending transmissions - Fcan clock : 4*Tcy (Fosc) - Baud rate is set according to given parameters - CAN mode : Normal - Filter and mask registers IDs are set to zero - Filter and mask message frame type is set according to <code>CANSPI_CONFIG_FLAGS</code> value <p><code>SAM</code>, <code>SEG2PHTS</code>, <code>WAKFIL</code> and <code>DBEN</code> bits are set according to <code>CANSPI_CONFIG_FLAGS</code> value.</p>
Parameters	<ul style="list-style-type: none"> - <code>SJW</code> as defined in MCU's datasheet (CAN Module) - <code>BRP</code> as defined in MCU's datasheet (CAN Module) - <code>PHSEG1</code> as defined in MCU's datasheet (CAN Module) - <code>PHSEG2</code> as defined in MCU's datasheet (CAN Module) - <code>PROPSEG</code> as defined in MCU's datasheet (CAN Module) - <code>CANSPI_CONFIG_FLAGS</code> is formed from predefined constants. See <code>CANSPI_CONFIG_FLAGS</code> constants.
Returns	Nothing.

<p>Requires</p>	<p>Global variables :</p> <ul style="list-style-type: none"> - CanSpi_CS: Chip Select line - CanSpi_Rst: Reset line - CanSpi_CS_Direction: Direction of the Chip Select pin - CanSpi_Rst_Direction: Direction of the Reset pin <p>must be defined before using this function.</p> <p>The CANSPI routines are supported only by MCUs with the SPI module.</p> <p>The SPI module needs to be initialized. See the <code>SPIx_Init</code> and <code>SPIx_Init_Advanced</code> routines.</p> <p>MCU has to be properly connected to mikroElektronika's CANSPI Extra Board or similar hardware. See connection example at the bottom of this page.</p>
<p>Example</p>	<pre> // CANSPI module connections sbit CanSpi_CS at RF0_bit; sbit CanSpi_CS_Direction at TRISF0_bit; sbit CanSpi_Rst at RF1_bit; sbit CanSpi_Rst_Direction at TRISF1_bit; // End CANSPI module connections // initialize the CANSPI module with the appropriate baud rate and message // acceptance flags along with the sampling rules char CANSPI_Init_Flags; ... CANSPI_Init_Flags = _CANSPI_CONFIG_SAMPLE_THRICE & // form value to be used _CANSPI_CONFIG_PHSEG2_PRG_ON & // with CANSPIInitialize _CANSPI_CONFIG_XTD_MSG & _CANSPI_CONFIG_DBL_BUFFER_ON & _CANSPI_CONFIG_VALID_XTD_MSG; ... SPI1_Init(); // initialize SPI1 module CANSPIInitialize(1,3,3,3,1,CANSPI_Init_Flags); // initialize external CANSPI module </pre>
<p>Notes</p>	<p>- CANSPI mode NORMAL will be set on exit.</p>

CANSPISetBaudRate

Prototype	<code>void CANSPISetBaudRate(char SJW, char BRP, char PHSEG1, char PHSEG2, char PROPSEG, char CANSPI_CONFIG_FLAGS);</code>
Returns	Nothing.
Description	<p>Sets the CANSPI module baud rate. Due to complexity of the CAN protocol, you can not simply force a bps value. Instead, use this function when the CANSPI module is in Config mode.</p> <p><code>SAM</code>, <code>SEG2PHTS</code> and <code>WAKFIL</code> bits are set according to <code>CANSPI_CONFIG_FLAGS</code> value. Refer to datasheet for details.</p>
Parameters	<ul style="list-style-type: none"> - <code>SJW</code> as defined in MCU's datasheet (CAN Module) - <code>BRP</code> as defined in MCU's datasheet (CAN Module) - <code>PHSEG1</code> as defined in MCU's datasheet (CAN Module) - <code>PHSEG2</code> as defined in MCU's datasheet (CAN Module) - <code>PROPSEG</code> as defined in MCU's datasheet (CAN Module) - <code>CANSPI_CONFIG_FLAGS</code> is formed from predefined constants. See <code>CANSPI_CONFIG_FLAGS</code> constants.
Returns	Nothing.
Requires	<p>The CANSPI module must be in Config mode, otherwise the function will be ignored. See <code>CANSPISetOperationMode</code>.</p> <p>The CANSPI routines are supported only by MCUs with the SPI module.</p> <p>MCU has to be properly connected to mikroElektronika's CANSPI Extra Board or similar hardware. See connection example at the bottom of this page.</p>
Example	<pre>// set required baud rate and sampling rules char CANSPI_CONFIG_FLAGS; ... CANSPISetOperationMode(_CANSPI_MODE_CONFIG,0xFF); // set CONFIGURATION mode (CANSPI module must be in config mode for baud rate settings) CANSPI_CONFIG_FLAGS = _CANSPI_CONFIG_SAMPLE_THRICE & _CANSPI_CONFIG_PHSEG2_PRG_ON & _CANSPI_CONFIG_STD_MSG & _CANSPI_CONFIG_DBL_BUFFER_ON & _CANSPI_CONFIG_VALID_XTD_MSG & _CANSPI_CONFIG_LINE_FILTER_OFF; CANSPISetBaudRate(1, 1, 3, 3, 1, CANSPI_CONFIG_FLAGS);</pre>
Notes	None.

CANSPISetMask

Prototype	<code>void CANSPISetMask(unsigned short CANSPI_MASK, long value, unsigned short CANSPI_CONFIG_FLAGS);</code>
Description	Configures mask for advanced filtering of messages. The parameter value is bit-adjusted to the appropriate mask registers.
Parameters	<ul style="list-style-type: none"> - <code>CANSPI_MASK</code>: CAN module mask number. Valid values: <code>CANSPI_MASK</code> constants. See <code>CANSPI_MASK</code> constants. - <code>val</code>: mask register value. This value is bit-adjusted to appropriate buffer mask registers - <code>CANSPI_CONFIG_FLAGS</code>: selects type of message to filter. Valid values: <ul style="list-style-type: none"> - <code>_CANSPI_CONFIG_ALL_VALID_MSG</code>, - <code>_CANSPI_CONFIG_MATCH_MSG_TYPE & _CANSPI_CONFIG_STD_MSG</code>, - <code>_CANSPI_CONFIG_MATCH_MSG_TYPE & _CANSPI_CONFIG_XTD_MSG</code>. <p>See <code>CANSPI_CONFIG_FLAGS</code> constants.</p>
Returns	Nothing.
Requires	<p>The CANSPI module must be in Config mode, otherwise the function will be ignored. See <code>CANSPISetOperationMode</code>.</p> <p>The CANSPI routines are supported only by MCUs with the SPI module.</p> <p>MCU has to be properly connected to mikroElektronika's CANSPI Extra Board or similar hardware. See connection example at the bottom of this page.</p>
Example	<pre>// set the appropriate filter mask and message type value CANSPISetOperationMode(_CANSPI_MODE_CONFIG,0xFF); // set CONFIGURATION mode (CANSPI module must be in config mode for mask settings) // Set all B1 mask bits to 1 (all filtered bits are relevant): // Note that -1 is just a cheaper way to write 0xFFFFFFFF. // Complement will do the trick and fill it up with ones. CANSPISetMask(_CANSPI_MASK_B1, -1, _CANSPI_CONFIG_MATCH_MSG_TYPE & _CANSPI_ CONFIG_XTD_MSG);</pre>
Notes	None.

CANSPISetFilter

Prototype	<code>void CANSPISetFilter(unsigned short CANSPI_FILTER, long value, unsigned short CANSPI_CONFIG_FLAGS);</code>
Description	Configures message filter. The parameter value is bit-adjusted to the appropriate filter registers.
Parameters	<ul style="list-style-type: none"> - <code>CANSPI_FILTER</code>: CAN module filter number. Valid values: <code>CANSPI_FILTER</code> constants. See <code>CANSPI_FILTER</code> constants. - <code>val</code>: filter register value. This value is bit-adjusted to appropriate filter registers - <code>CANSPI_CONFIG_FLAGS</code>: selects type of message to filter. Valid values: <code>_CANSPI_CONFIG_STD_MSG</code> and <code>_CANSPI_CONFIG_XTD_MSG</code>. See <code>CANSPI_CONFIG_FLAGS</code> constants.
Returns	Nothing.
Requires	<p>The CANSPI module must be in Config mode, otherwise the function will be ignored. See <code>CANSPISetOperationMode</code>.</p> <p>The CANSPI routines are supported only by MCUs with the SPI module.</p> <p>MCU has to be properly connected to mikroElektronika's CANSPI Extra Board or similar hardware. See connection example at the bottom of this page.</p>
Example	<pre>// set the appropriate filter value and message type CANSPISetOperationMode(_CANSPI_MODE_CONFIG,0xFF); // set CONFIGURATION mode (CANSPI module must be in config mode for filter settings) // Set id of filter B1_F1 to 3 : CANSPISetFilter(_CANSPI_FILTER_B1_F1, 3, _CANSPI_CONFIG_XTD_MSG);</pre>
Notes	None.

CANSPIRead

Prototype	<code>unsigned short CANSPIRead(long *id, unsigned short *data, unsigned short *datalen, unsigned short *CANSPI_RX_MSG_FLAGS);</code>
Description	<p>If at least one full Receive Buffer is found, it will be processed in the following way:</p> <ul style="list-style-type: none"> - Message ID is retrieved and stored to location provided by the <code>id</code> parameter - Message data is retrieved and stored to a buffer provided by the <code>data</code> parameter - Message length is retrieved and stored to location provided by the <code>dataLen</code> parameter - Message flags are retrieved and stored to location provided by the <code>CANSPI_RX_MSG_FLAGS</code> parameter
Parameters	<ul style="list-style-type: none"> - <code>id</code>: message identifier address - <code>data</code>: an array of bytes up to 8 bytes in length - <code>dataLen</code>: data length address - <code>CANSPI_RX_MSG_FLAGS</code>: message flags address. For message receive flags format refer to <code>CANSPI_RX_MSG_FLAGS</code> constants. See <code>CANSPI_RX_MSG_FLAGS</code> constants.
Returns	<ul style="list-style-type: none"> - 0 if nothing is received - 0xFFFF if one of the Receive Buffers is full (message received)
Requires	<p>The CANSPI module must be in a mode in which receiving is possible. See <code>CANSPISetOperationMode</code>.</p> <p>The CANSPI routines are supported only by MCUs with the SPI module.</p> <p>MCU has to be properly connected to mikroElektronika's CANSPI Extra Board or similar hardware. See connection example at the bottom of this page.</p>
Example	<pre>// check the CANSPI module for received messages. If any was received do something. unsigned short msg_rcvd, rx_flags, data_len; char data[8]; unsigned long msg_id; ... CANSPISetOperationMode(_CANSPI_MODE_NORMAL,0xFF); // set NORMAL mode (CANSPI module must be in mode in which receive is possible) ... rx_flags = 0; // clear message flags if (msg_rcvd = CANSPIRead(msg_id, data, data_len, rx_flags)) { ... }</pre>
Notes	None.

CANSPIWrite

Prototype	<code>unsigned short CANSPIWrite(long id, unsigned short *data, unsigned short datalen, unsigned short CANSPI_TX_MSG_FLAGS);</code>
Description	If at least one empty Transmit Buffer is found, the function sends message in the queue for transmission.
Parameters	<ul style="list-style-type: none"> - <code>id</code>: CAN message identifier. Valid values: 11 or 29 bit values, depending on message type (standard or extended) - <code>Data</code>: data to be sent - <code>DataLen</code>: data length. Valid values: 0..8 - <code>CANSPI_TX_MSG_FLAGS</code>: message flags. Valid values: <code>CANSPI_TX_MSG_FLAGS</code> constants. See <code>CANSPI_TX_MSG_FLAGS</code> constants.
Returns	<ul style="list-style-type: none"> - 0 if all Transmit Buffers are busy - 0xFFFF if at least one Transmit Buffer is available
Requires	<p>The CANSPI module must be in mode in which transmission is possible. See <code>CANSPISetOperationMode</code>.</p> <p>The CANSPI routines are supported only by MCUs with the SPI module.</p> <p>MCU has to be properly connected to mikroElektronika's CANSPI Extra Board or similar hardware. See connection example at the bottom of this page.</p>
Example	<pre>// send message extended CAN message with the appropriate ID and data unsigned short tx_flags; char data[8]; long msg_id; ... CANSPISetOperationMode(CANSPI_MODE_NORMAL, 0xFF); // set NORMAL mode (CANSPI must be in mode in which transmission is possible) tx_flags = _CANSPI_TX_PRIORITY_0 & _CANSPI_TX_XTD_FRAME; // set message flags CANSPIWrite(msg_id, data, 2, tx_flags);</pre>
Notes	None.

CANSPI Constants

There is a number of constants predefined in the CANSPI library. You need to be familiar with them in order to be able to use the library effectively. Check the example at the end of the chapter.

CANSPI_OP_MODE Constants

The `CANSPI_OP_MODE` constants define CANSPI operation mode. Function `CANSPISetOperationMode` expects one of these as it's argument:

Copy Code To Clipboard

```
const unsigned int
_CANSPI_MODE_BITS      = 0xE0,    // Use this to access opmode bits
_CANSPI_MODE_NORMAL    = 0x00,
_CANSPI_MODE_SLEEP     = 0x20,
_CANSPI_MODE_LOOP      = 0x40,
_CANSPI_MODE_LISTEN    = 0x60,
_CANSPI_MODE_CONFIG    = 0x80;
```

CANSPI_CONFIG_FLAGS Constants

The `CANSPI_CONFIG_FLAGS` constants define flags related to the CANSPI module configuration. The functions `CANSPIInit`, `CANSPISetBaudRate`, `CANSPISetMask` and `CANSPISetFilter` expect one of these (or a bitwise combination) as their argument:

Copy Code To Clipboard

```
const unsigned int
_CANSPI_CONFIG_DEFAULT          = 0xFF,    // 11111111

_CANSPI_CONFIG_PHSEG2_PRG_BIT   = 0x01,
_CANSPI_CONFIG_PHSEG2_PRG_ON   = 0xFF,    // XXXXXXX1
_CANSPI_CONFIG_PHSEG2_PRG_OFF  = 0xFE,    // XXXXXXX0

_CANSPI_CONFIG_LINE_FILTER_BIT = 0x02,
_CANSPI_CONFIG_LINE_FILTER_ON  = 0xFF,    // XXXXXX1X
_CANSPI_CONFIG_LINE_FILTER_OFF = 0xFD,    // XXXXXX0X

_CANSPI_CONFIG_SAMPLE_BIT      = 0x04,
_CANSPI_CONFIG_SAMPLE_ONCE     = 0xFF,    // XXXXX1XX
_CANSPI_CONFIG_SAMPLE_THRICE   = 0xFB,    // XXXXX0XX

_CANSPI_CONFIG_MSG_TYPE_BIT    = 0x08,
_CANSPI_CONFIG_STD_MSG         = 0xFF,    // XXXX1XXX
_CANSPI_CONFIG_XTD_MSG         = 0xF7,    // XXXX0XXX

_CANSPI_CONFIG_DBL_BUFFER_BIT  = 0x10,
_CANSPI_CONFIG_DBL_BUFFER_ON   = 0xFF,    // XXX1XXXX
_CANSPI_CONFIG_DBL_BUFFER_OFF  = 0xEF,    // XXX0XXXX

_CANSPI_CONFIG_MSG_BITS        = 0x60,
_CANSPI_CONFIG_ALL_MSG         = 0xFF,    // X11XXXXX
_CANSPI_CONFIG_VALID_XTD_MSG   = 0xDF,    // X10XXXXX
_CANSPI_CONFIG_VALID_STD_MSG   = 0xBF,    // X01XXXXX
_CANSPI_CONFIG_ALL_VALID_MSG   = 0x9F;    // X00XXXXX
```

You may use bitwise AND (&) to form config byte out of these values. For example:

Copy Code To Clipboard

```
init = _CANSPI_CONFIG_SAMPLE_THRICE &
       _CANSPI_CONFIG_PHSEG2_PRG_ON &
       _CANSPI_CONFIG_STD_MSG      &
       _CANSPI_CONFIG_DBL_BUFFER_ON &
       _CANSPI_CONFIG_VALID_XTD_MSG &
       _CANSPI_CONFIG_LINE_FILTER_OFF;
...
CANSPIInit(1, 1, 3, 3, 1, init); // initialize CANSPI
```

CANSPI_TX_MSG_FLAGS Constants

CANSPI_TX_MSG_FLAGS are flags related to transmission of a CANSPI message:

Copy Code To Clipboard

```
const unsigned int
_CANSPI_TX_PRIORITY_BITS = 0x03,
_CANSPI_TX_PRIORITY_0   = 0xFC, // XXXXXX00
_CANSPI_TX_PRIORITY_1   = 0xFD, // XXXXXX01
_CANSPI_TX_PRIORITY_2   = 0xFE, // XXXXXX10
_CANSPI_TX_PRIORITY_3   = 0xFF, // XXXXXX11

_CANSPI_TX_FRAME_BIT    = 0x08,
_CANSPI_TX_STD_FRAME    = 0xFF, // XXXXX1XX
_CANSPI_TX_XTD_FRAME    = 0xF7, // XXXXX0XX

_CANSPI_TX_RTR_BIT      = 0x40,
_CANSPI_TX_NO_RTR_FRAME = 0xFF, // X1XXXXXX
_CANSPI_TX_RTR_FRAME    = 0xBF; // X0XXXXXX
```

You may use bitwise AND (&) to adjust the appropriate flags. For example:

Copy Code To Clipboard

```
// form value to be used as sending message flag :
send_config = _CANSPI_TX_PRIORITY_0 &
              _CANSPI_TX_XTD_FRAME &
              _CANSPI_TX_NO_RTR_FRAME;
...
CANSPIWrite(id, data, 1, send_config);
```

CANSPI_RX_MSG_FLAGS Constants

CANSPI_RX_MSG_FLAGS are flags related to reception of CANSPI message. If a particular bit is set then corresponding meaning is TRUE or else it will be FALSE.

Copy Code To Clipboard

```
const unsigned int
  _CANSPI_RX_FILTER_BITS = 0x07, // Use this to access filter bits
  _CANSPI_RX_FILTER_1   = 0x00,
  _CANSPI_RX_FILTER_2   = 0x01,
  _CANSPI_RX_FILTER_3   = 0x02,
  _CANSPI_RX_FILTER_4   = 0x03,
  _CANSPI_RX_FILTER_5   = 0x04,
  _CANSPI_RX_FILTER_6   = 0x05,

  _CANSPI_RX_OVERFLOW    = 0x08, // Set if Overflowed else cleared
  _CANSPI_RX_INVALID_MSG = 0x10, // Set if invalid else cleared
  _CANSPI_RX_XTD_FRAME   = 0x20, // Set if XTD message else cleared
  _CANSPI_RX_RTR_FRAME   = 0x40, // Set if RTR message else cleared
  _CANSPI_RX_DBL_BUFFERED = 0x80; // Set if this message was hardware double-buffered
```

You may use bitwise AND (&) to adjust the appropriate flags. For example:

Copy Code To Clipboard

```
if (MsgFlag & _CANSPI_RX_OVERFLOW != 0) {
  ...
  // Receiver overflow has occurred.
  // We have lost our previous message.
}
```

CANSPI_MASK Constants

The `CANSPI_MASK` constants define mask codes. Function `CANSPISetMask` expects one of these as it's argument:

Copy Code To Clipboard

```
const unsigned int
  _CANSPI_MASK_B1 = 0,
  _CANSPI_MASK_B2 = 1;
```

CANSPI_FILTER Constants

The `CANSPI_FILTER` constants define filter codes. Functions `CANSPISetFilter` expects one of these as it's argument:

Copy Code To Clipboard

```
const unsigned int
  _CANSPI_FILTER_B1_F1 = 0,
  _CANSPI_FILTER_B1_F2 = 1,
  _CANSPI_FILTER_B2_F1 = 2,
  _CANSPI_FILTER_B2_F2 = 3,
  _CANSPI_FILTER_B2_F3 = 4,
  _CANSPI_FILTER_B2_F4 = 5;
```

Library Example

This is a simple demonstration of CANSPI Library routines usage. First node initiates the communication with the second node by sending some data to its address. The second node responds by sending back the data incremented by 1. First node then does the same and sends incremented data back to second node, etc.

Code for the first CANSPI node:

Copy Code To Clipboard

```

sbit CanSpi_CS at RF0_bit;           // Chip select line
sbit CanSpi_Rst at RF1_bit;         // Reset line
sbit CanSpi_CS_Direction at TRISF0_bit; // Direction of the Chip Select pin
sbit CanSpi_Rst_Direction at TRISF1_bit; // Direction of the Reset pin

unsigned int Can_Init_Flags, Can_Send_Flags, Can_Rcv_Flags; // Can flags
unsigned int Rx_Data_Len;           // Received data length in bytes
char RxTx_Data[8];                 // Can rx/tx data buffer
char Msg_Rcvd;                     // Reception flag
unsigned long Tx_ID, Rx_ID;         // Can rx and tx ID

void main() {
    ADPCFG = 0xFFFF;
    PORTB = 0;
    TRISB = 0;

    Can_Init_Flags = 0;             //
    Can_Send_Flags = 0;            // Clear flags
    Can_Rcv_Flags = 0;             //

    Can_Send_Flags = _CANSPI_TX_PRIORITY_0 & // Form value to be used
                     _CANSPI_TX_XTD_FRAME & // with CANSPI1Write
                     _CANSPI_TX_NO_RTR_FRAME;

    Can_Init_Flags = _CANSPI_CONFIG_SAMPLE_THRICE & // Form value to be used
                    _CANSPI_CONFIG_PHSEG2_PRG_ON & // with CANSPI1Init
                    _CANSPI_CONFIG_XTD_MSG &
                    _CANSPI_CONFIG_DBL_BUFFER_ON &
                    _CANSPI_CONFIG_VALID_XTD_MSG;

    SPI1_Init();                   // Initialize SPI1 module
    CANSPIInitialize(1,3,3,3,1,Can_Init_Flags); // Initialize external CANSPI module

    CANSPISetOperationMode(_CANSPI_MODE_CONFIG,0xFF); // Set CONFIGURATION mode

    CANSPISetMask(_CANSPI_MASK_B1,-1,_CANSPI_CONFIG_XTD_MSG); // Set all mask1 bits to
ones
    CANSPISetMask(_CANSPI_MASK_B2,-1,_CANSPI_CONFIG_XTD_MSG); // Set all mask2 bits to
ones
    CANSPISetFilter(_CANSPI_FILTER_B2_F4,3,_CANSPI_CONFIG_XTD_MSG); // Set id of filter
B1_F1 to 3

```

```
CANSPISetOperationMode(_CANSPI_MODE_NORMAL,0xFF); // Set NORMAL mode

RxTx_Data[0] = 9; // Set initial data to be sent

Tx_ID = 12111; // Set transmit ID

CANSPIWrite(Tx_ID, RxTx_Data, 1, Can_Send_Flags); // Send initial message

while(1) { // Endless loop
    Msg_Rcvd = CANSPIRead(&Rx_ID , RxTx_Data , &Rx_Data_Len, &Can_Rcv_Flags); // Receive
message
    if ((Rx_ID == 3u) && Msg_Rcvd) { // If message received check id
        PORTB = RxTx_Data[0]; // Id correct, output data at PORTB
        RxTx_Data[0]++; // Increment received data
        Delay_ms(10);
        CANSPIWrite(Tx_ID, RxTx_Data, 1, Can_Send_Flags); // Send incremented data back
    }
}
}
```

Code for the second CANSPI node:

Copy Code To Clipboard

```
sbit CanSpi_CS at RF0_bit; // Chip select line
sbit CanSpi_Rst at RF1_bit; // Reset line
sbit CanSpi_CS_Direction at TRISF0_bit; // Direction of the Chip Select pin
sbit CanSpi_Rst_Direction at TRISF1_bit; // Direction of the Reset pin

unsigned int Can_Init_Flags, Can_Send_Flags, Can_Rcv_Flags; // Can flags
unsigned int Rx_Data_Len; // Received data length in
bytes
char RxTx_Data[8]; // Can rx/tx data buffer
char Msg_Rcvd; // Reception flag
unsigned long Tx_ID, Rx_ID; // Can rx and tx ID

void main() {
    ADPCFG = 0xFFFF;
    PORTB = 0;
    TRISB = 0;

    Can_Init_Flags = 0; //
    Can_Send_Flags = 0; // Clear flags
    Can_Rcv_Flags = 0; //

    Can_Send_Flags = _CANSPI_TX_PRIORITY_0 & // Form value to be used
                     _CANSPI_TX_XTD_FRAME & // with CANSPIWrite
                     _CANSPI_TX_NO_RTR_FRAME;

    Can_Init_Flags = _CANSPI_CONFIG_SAMPLE_THRICE & // Form value to be used
                     _CANSPI_CONFIG_PHSEG2_PRG_ON & // with CANSPIInit
                     _CANSPI_CONFIG_XTD_MSG &
```

```

        _CANSPI_CONFIG_DBL_BUFFER_ON &
        _CANSPI_CONFIG_VALID_XTD_MSG &
        _CANSPI_CONFIG_LINE_FILTER_OFF;

SPI1_Init(); // Initialize SPI1 module
CANSPIInitialize(1,3,3,3,1,Can_Init_Flags); // Initialize CANSPI module

CANSPISetOperationMode(_CANSPI_MODE_CONFIG,0xFF); // Set CONFIGURATION mode

CANSPISetMask(_CANSPI_MASK_B1,-1,_CANSPI_CONFIG_XTD_MSG); // Set all mask1
bits to ones
CANSPISetMask(_CANSPI_MASK_B2,-1,_CANSPI_CONFIG_XTD_MSG); // Set all mask2
bits to ones
CANSPISetFilter(_CANSPI_FILTER_B2_F3,12111,_CANSPI_CONFIG_XTD_MSG); // Set id of
filter B1_F1 to 3

CANSPISetOperationMode(_CANSPI_MODE_NORMAL,0xFF); // Set NORMAL mode

Tx_ID = 3; // Set tx ID

while (1) { // Endless loop
    Msg_Rcvd = CANSPIRead(&Rx_ID , RxTx_Data , &Rx_Data_Len, &Can_Rcv_Flags); //
Receive message
    if ((Rx_ID == 12111u) && Msg_Rcvd) { // If message received check id
        PORTB = RxTx_Data[0]; // Id correct, output data at PORTB
        RxTx_Data[0]++; // Increment received data
        CANSPIWrite(Tx_ID, RxTx_Data, 1, Can_Send_Flags); // Send incremented data back
    }
}
}

```

HW Connection

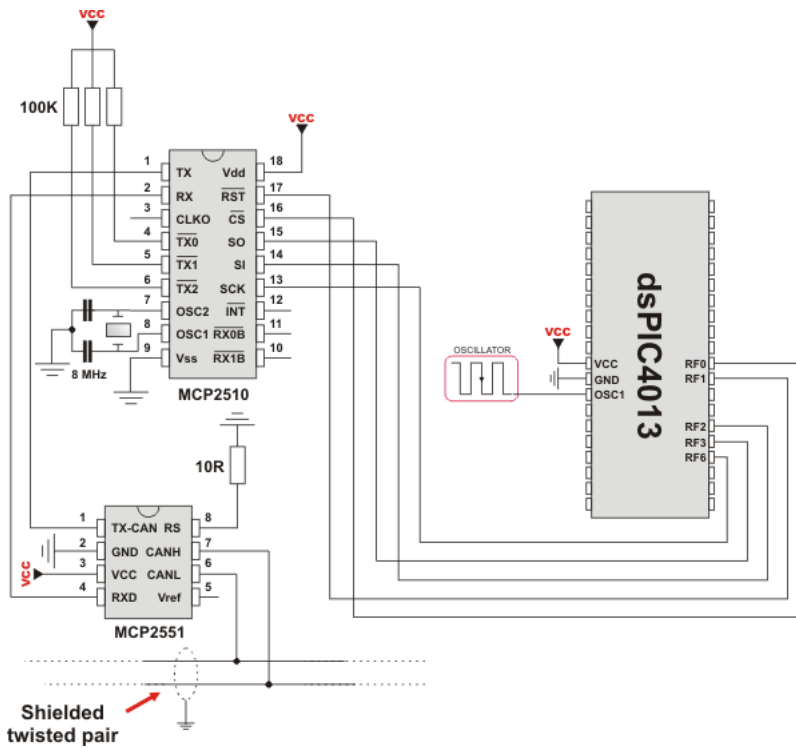

Example of interfacing CAN transceiver MCP2510 with MCU via SPI interface

Compact Flash Library

The Compact Flash Library provides routines for accessing data on Compact Flash card (abbr. CF further in text). CF cards are widely used memory elements, commonly used with digital cameras. Great capacity and excellent access time of only a few microseconds make them very attractive for microcontroller applications.

In CF card, data is divided into sectors. One sector usually comprises 512 bytes. Routines for file handling, the Cf_Fat routines, are not performed directly but successively through 512B buffer.

Important :

- Routines for file handling can be used only with FAT16 file system.
- Library functions create and read files from the root directory only.
- Library functions populate both FAT1 and FAT2 tables when writing to files, but the file data is being read from the FAT1 table only; i.e. there is no recovery if the FAT1 table gets corrupted.
- If MMC/SD card has Master Boot Record (MBR), the library will work with the first available primary (logical) partition that has non-zero size. If MMC/SD card has Volume Boot Record (i.e. there is only one logical partition and no MBRs), the library works with entire card as a single partition. For more information on MBR, physical and logical drives, primary/secondary partitions and partition tables, please consult other resources, e.g. Wikipedia and similar.
- Before writing operation, make sure not to overwrite boot or FAT sector as it could make your card on PC or digital camera unreadable. Drive mapping tools, such as Winhex, can be of great assistance.

Library Dependency Tree

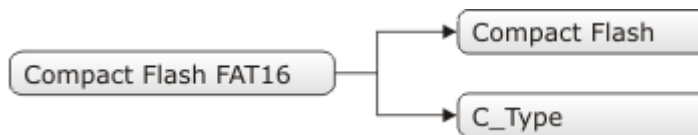

External dependencies of Compact Flash Library

The following variables must be defined in all projects using Compact Flash Library:	Description :	Example :
<code>extern sfr unsigned int CF_Data_Port;</code>	Compact Flash Data Port.	<code>char CF_Data_Port at PORTF;</code>
<code>extern sfr sbit CF_RDY;</code>	Ready signal line.	<code>sbit CF_RDY at RD7_bit;</code>
<code>extern sfr sbit CF_WE;</code>	Write Enable signal line.	<code>sbit CF_WE at RD6_bit;</code>
<code>extern sfr sbit CF_OE;</code>	Output Enable signal line.	<code>sbit CF_OE at RD5_bit;</code>
<code>extern sfr sbit CF_CD1;</code>	Chip Detect signal line.	<code>sbit CF_CD1 at RD4_bit;</code>
<code>extern sfr sbit CF_CE1;</code>	Chip Enable signal line.	<code>sbit CF_CE1 at RD3_bit;</code>
<code>extern sfr sbit CF_A2;</code>	Address pin 2.	<code>sbit CF_A2 at RD2_bit;</code>
<code>extern sfr sbit CF_A1;</code>	Address pin 1.	<code>sbit CF_A1 at RD1_bit;</code>
<code>extern sfr sbit CF_A0;</code>	Address pin 0.	<code>sbit CF_A0 at RD0_bit;</code>
<code>extern sfr sbit CF_RDY_direction;</code>	Direction of the Ready pin.	<code>sbit CF_RDY_direction at TRISD7_bit;</code>
<code>extern sfr sbit CF_WE_direction;</code>	Direction of the Write Enable pin.	<code>sbit CF_WE_direction at TRISDB6_bit;</code>
<code>extern sfr sbit CF_OE_direction;</code>	Direction of the Output Enable pin.	<code>sbit CF_OE_direction at TRISD5_bit;</code>
<code>extern sfr sbit CF_CD1_direction;</code>	Direction of the Chip Detect pin.	<code>sbit CF_CD1_direction at TRISD4_bit;</code>
<code>extern sfr sbit CF_CE1_direction;</code>	Direction of the Chip Enable pin.	<code>sbit CF_CE1_direction at TRISD3_bit;</code>
<code>extern sfr sbit CF_A2_direction;</code>	Direction of the Address 2 pin.	<code>sbit CF_A2_direction at TRISD2_bit;</code>
<code>extern sfr sbit CF_A1_direction;</code>	Direction of the Address 1 pin.	<code>sbit CF_A1_direction at TRISD1_bit;</code>
<code>extern sfr sbit CF_A0_direction;</code>	Direction of the Address 0 pin.	<code>sbit CF_A0_direction at TRISD0_bit;</code>

Library Routines

- Cf_Init
- Cf_Detect
- Cf_Enable
- Cf_Disable
- Cf_Read_Init
- Cf_Read_Byte
- Cf_Write_Init
- Cf_Write_Byte
- Cf_Read_Sector
- Cf_Write_Sector

Routines for file handling:

- Cf_Fat_Init
- Cf_Fat_QuickFormat
- Cf_Fat_Assign
- Cf_Fat_Reset
- Cf_Fat_Read
- Cf_Fat_Rewrite
- Cf_Fat_Append
- Cf_Fat_Delete
- Cf_Fat_Write
- Cf_Fat_Set_File_Date
- Cf_Fat_Get_File_Date
- Cf_Fat_Get_File_Date_Modified
- Cf_Fat_Get_File_Size
- Cf_Fat_Get_Swap_File

The following routine is for the internal use by compiler only:

- Cf_Issue_ID_Command

Cf_Init

Prototype	<code>void Cf_Init();</code>
Description	Initializes ports appropriately for communication with CF card.
Parameters	None.
Returns	Nothing.
Requires	<p>Global variables :</p> <ul style="list-style-type: none"> - <code>CF_Data_Port</code> : Compact Flash data port - <code>CF_RDY</code> : Ready signal line - <code>CF_WE</code> : Write enable signal line - <code>CF_OE</code> : Output enable signal line - <code>CF_CD1</code> : Chip detect signal line - <code>CF_CE1</code> : Enable signal line - <code>CF_A2</code> : Address pin 2 - <code>CF_A1</code> : Address pin 1 - <code>CF_A0</code> : Address pin 0 - <code>CF_RDY_direction</code> : Direction of the Ready pin - <code>CF_WE_direction</code> : Direction of the Write enable pin - <code>CF_OE_direction</code> : Direction of the Output enable pin - <code>CF_CD1_direction</code> : Direction of the Chip detect pin - <code>CF_CE1_direction</code> : Direction of the Chip enable pin - <code>CF_A2_direction</code> : Direction of the Address 2 pin - <code>CF_A1_direction</code> : Direction of the Address 1 pin - <code>CF_A0_direction</code> : Direction of the Address 0 pin <p>must be defined before using this function.</p>
Example	<pre>// set compact flash pinout char Cf_Data_Port at PORTF; sbit CF_RDY at RD7_bit; sbit CF_WE at RD6_bit; sbit CF_OE at RD5_bit; sbit CF_CD1 at RD4_bit; sbit CF_CE1 at RD3_bit; sbit CF_A2 at RD2_bit; sbit CF_A1 at RD1_bit; sbit CF_A0 at RD0_bit; sbit CF_RDY_direction at TRISD7_bit; sbit CF_WE_direction at TRISD6_bit; sbit CF_OE_direction at TRISD5_bit; sbit CF_CD1_direction at TRISD4_bit; sbit CF_CE1_direction at TRISD3_bit; sbit CF_A2_direction at TRISD2_bit; sbit CF_A1_direction at TRISD1_bit; sbit CF_A0_direction at TRISD0_bit; // end of compact flash pinout ... Cf_Init(); // initialize CF</pre>
Notes	None.

Cf_Detect

Prototype	<code>unsigned int Cf_Detect();</code>
Description	Checks for presence of CF card by reading the <code>chip detect</code> pin.
Parameters	None.
Returns	- 1 - if CF card was detected - 0 - otherwise
Requires	The corresponding MCU ports must be appropriately initialized for CF card. See <code>Cf_Init</code> .
Example	<pre>// Wait until CF card is inserted: do asm nop; while (!Cf_Detect());</pre>
Notes	dsPIC30 family MCU and CF card voltage levels are different. The user must ensure that MCU's pin connected to CD line can read CF card Logical One correctly.

Cf_Enable

Prototype	<code>void Cf_Enable();</code>
Description	Enables the device. Routine needs to be called only if you have disabled the device by means of the <code>Cf_Disable</code> routine. These two routines in conjunction allow you to free/occupy data line when working with multiple devices.
Parameters	None.
Returns	Nothing.
Requires	The corresponding MCU ports must be appropriately initialized for CF card. See <code>Cf_Init</code> .
Example	<pre>// enable compact flash Cf_Enable();</pre>
Notes	None.

Cf_Disable

Prototype	<code>void Cf_Disable();</code>
Description	Routine disables the device and frees the data lines for other devices. To enable the device again, call <code>Cf_Enable</code> . These two routines in conjunction allow you to free/occupy data line when working with multiple devices.
Parameters	None.
Returns	Nothing.
Requires	The corresponding MCU ports must be appropriately initialized for CF card. See <code>Cf_Init</code> .
Example	<pre>// disable compact flash Cf_Disable();</pre>
Notes	None.

Cf_Read_Init

Prototype	<code>void Cf_Read_Init(unsigned long address, unsigned short sector_count);</code>
Description	Initializes CF card for reading.
Parameters	- <code>address</code> : the first sector to be prepared for reading operation. - <code>sector_count</code> : number of sectors to be prepared for reading operation.
Returns	Nothing.
Requires	The corresponding MCU ports must be appropriately initialized for CF card. See <code>Cf_Init</code> .
Example	<pre>// initialize compact flash for reading from sector 590 Cf_Read_Init(590, 1);</pre>
Notes	None.

Cf_Read_Byte

Prototype	<code>unsigned char Cf_Read_Byte();</code>
Description	Reads one byte from Compact Flash sector buffer location currently pointed to by internal read pointers. These pointers will be autoincremented upon reading.
Parameters	None.
Returns	Returns a byte read from Compact Flash sector buffer.
Requires	The corresponding MCU ports must be appropriately initialized for CF card. See <code>Cf_Init</code> . CF card must be initialized for reading operation. See <code>Cf_Read_Init</code> .
Example	<pre>// Read a byte from compact flash: unsigned char data_; ... data_ = Cf_Read_Byte();</pre>
Notes	Higher byte of the <code>unsigned</code> return value is cleared.

Cf_Write_Init

Prototype	<code>void Cf_Write_Init(unsigned long address, unsigned short sectcnt);</code>
Description	Initializes CF card for writing.
Parameters	- <code>address</code> : the first sector to be prepared for writing operation. - <code>sectcnt</code> : number of sectors to be prepared for writing operation.
Returns	Nothing.
Requires	The corresponding MCU ports must be appropriately initialized for CF card. See <code>Cf_Init</code> .
Example	<pre>// initialize compact flash for writing to sector 590 Cf_Write_Init(590, 1);</pre>
Notes	None.

Cf_Write_Byte

Prototype	<code>void Cf_Write_Byte(unsigned short data_);</code>
Description	Writes a byte to Compact Flash sector buffer location currently pointed to by writing pointers. These pointers will be autoincremented upon reading. When sector buffer is full, its contents will be transferred to appropriate flash memory sector.
Parameters	- <code>data_</code> : byte to be written.
Returns	Nothing.
Requires	The corresponding MCU ports must be appropriately initialized for CF card. See <code>Cf_Init</code> . CF card must be initialized for writing operation. See <code>Cf_Write_Init</code> .
Example	<pre>char data_ = 0xAA; ... Cf_Write_Byte(data_);</pre>
Notes	None.

Cf_Read_Sector

Prototype	<code>void Cf_Read_Sector(unsigned long sector_number, unsigned short *buffer);</code>
Description	Reads one sector (512 bytes). Read data is stored into buffer provided by the buffer parameter.
Parameters	- <code>sector_number</code> : sector to be read. - <code>buffer</code> : data buffer of at least 512 bytes in length.
Returns	Nothing.
Requires	The corresponding MCU ports must be appropriately initialized for CF card. See <code>Cf_Init</code> .
Example	<pre>// read sector 22 unsigned short data[512]; ... Cf_Read_Sector(22, data);</pre>
Notes	None.

Cf_Write_Sector

Prototype	<code>void Cf_Write_Sector(unsigned long sector_number, unsigned short *buffer);</code>
Description	Writes 512 bytes of data provided by the buffer parameter to one CF sector.
Parameters	- <code>sector_number</code> : sector to be written to. - <code>buffer</code> : data buffer of 512 bytes in length.
Returns	Nothing.
Requires	The corresponding MCU ports must be appropriately initialized for CF card. See <code>Cf_Init</code> .
Example	<pre>// write to sector 22 unsigned short data[512]; ... Cf_Write_Sector(22, data);</pre>
Notes	None.

Cf_Fat_Init

Prototype	<code>unsigned int Cf_Fat_Init();</code>
Description	Initializes CF card, reads CF FAT16 boot sector and extracts necessary data needed by the library.
Parameters	None.
Returns	- 0 - if CF card was detected and successfully initialized - 1 - if FAT16 boot sector was not found - 255 - if card was not detected
Requires	Nothing.
Example	<pre>// Init the FAT library if (!Cf_Fat_Init()) { // Init the FAT library ... }</pre>
Notes	None.

Cf_Fat_QuickFormat

Prototype	<code>unsigned int Cf_Fat_QuickFormat(char *cf_fat_label);</code>
Description	Formats to FAT16 and initializes CF card.
Parameters	- <code>cf_fat_label</code> : volume label (11 characters in length). If less than 11 characters are provided, the label will be padded with spaces. If null string is passed, the volume will not be labeled.
Returns	- 0 - if CF card was detected, successfully formatted and initialized - 1 - if FAT16 format was unsuccessful - 255 - if card was not detected
Requires	Nothing.
Example	<pre>// format and initialize the FAT library - if (!Cf_Fat_QuickFormat(&cf_fat_label)) { ... }</pre>
Notes	- This routine can be used instead or in conjunction with <code>Cf_Fat_Init</code> routine. - If CF card already contains a valid boot sector, it will remain unchanged (except volume label field) and only FAT and ROOT tables will be erased. Also, the new volume label will be set.

Cf_Fat_Assign

Prototype	<code>unsigned int Cf_Fat_Assign(char *filename, char file_cre_attr);</code>																											
Description	Assigns file for file operations (read, write, delete...). All subsequent file operations will be applied over the assigned file.																											
Parameters	<p>- <code>filename</code>: name of the file that should be assigned for file operations. The file name should be in DOS 8.3 (<code>file_name.extension</code>) format. The file name and extension will be automatically padded with spaces by the library if they have less than length required (i.e. "mikro.tx" -> "mikro .tx "), so the user does not have to take care of that. The file name and extension are case insensitive. The library will convert them to proper case automatically, so the user does not have to take care of that.</p> <p>Also, in order to keep backward compatibility with the first version of this library, file names can be entered as UPPERCASE string of 11 bytes in length with no dot character between the file name and extension (i.e. "MIKROELETXT" -> MIKROELE.TXT). In this case the last 3 characters of the string are considered to be file extension.</p> <p>- <code>file_cre_attr</code>: file creation and attributes flags. Each bit corresponds to the appropriate file attribute:</p> <table border="1" data-bbox="239 662 939 1072"> <thead> <tr> <th>Bit</th> <th>Mask</th> <th>Description</th> </tr> </thead> <tbody> <tr> <td>0</td> <td>0x01</td> <td>Read Only</td> </tr> <tr> <td>1</td> <td>0x02</td> <td>Hidden</td> </tr> <tr> <td>2</td> <td>0x04</td> <td>System</td> </tr> <tr> <td>3</td> <td>0x08</td> <td>Volume Label</td> </tr> <tr> <td>4</td> <td>0x10</td> <td>Subdirectory</td> </tr> <tr> <td>5</td> <td>0x20</td> <td>Archive</td> </tr> <tr> <td>6</td> <td>0x40</td> <td>Device (internal use only, never found on disk)</td> </tr> <tr> <td>7</td> <td>0x80</td> <td>File creation flag. If the file does not exist and this flag is set, a new file with specified name will be created.</td> </tr> </tbody> </table>	Bit	Mask	Description	0	0x01	Read Only	1	0x02	Hidden	2	0x04	System	3	0x08	Volume Label	4	0x10	Subdirectory	5	0x20	Archive	6	0x40	Device (internal use only, never found on disk)	7	0x80	File creation flag. If the file does not exist and this flag is set, a new file with specified name will be created.
Bit	Mask	Description																										
0	0x01	Read Only																										
1	0x02	Hidden																										
2	0x04	System																										
3	0x08	Volume Label																										
4	0x10	Subdirectory																										
5	0x20	Archive																										
6	0x40	Device (internal use only, never found on disk)																										
7	0x80	File creation flag. If the file does not exist and this flag is set, a new file with specified name will be created.																										
Returns	<p>- 0 if file does not exist and no new file is created.</p> <p>- 1 if file already exists or file does not exist but a new file is created.</p>																											
Requires	CF card and CF library must be initialized for file operations. See <code>Cf_Fat_Init</code> .																											
Example	<pre>// create file with archive attributes if it does not already exist Cf_Fat_Assign("MIKRO007.TXT", 0xA0);</pre>																											
Notes	Long File Names (LFN) are not supported.																											

Cf_Fat_Reset

Prototype	<code>void Cf_Fat_Reset(unsigned long *size);</code>
Description	Opens currently assigned file for reading.
Parameters	- <code>size</code> : buffer to store file size to. After file has been open for reading its size is returned through this parameter.
Returns	Nothing.
Requires	CF card and CF library must be initialized for file operations. See <code>Cf_Fat_Init</code> . File must be previously assigned. See <code>Cf_Fat_Assign</code> .
Example	<pre>unsigned long size; ... Cf_Fat_Reset(size);</pre>
Notes	None.

Cf_Fat_Read

Prototype	<code>void Cf_Fat_Read(unsigned short *bdata);</code>
Description	Reads a byte from currently assigned file opened for reading. Upon function execution file pointers will be set to the next character in the file.
Parameters	- <code>bdata</code> : buffer to store read byte to. Upon this function execution read byte is returned through this parameter.
Returns	Nothing.
Requires	CF card and CF library must be initialized for file operations. See <code>Cf_Fat_Init</code> . File must be previously assigned. See <code>Cf_Fat_Assign</code> . File must be open for reading. See <code>Cf_Fat_Reset</code> .
Example	<pre>char character; ... Cf_Fat_Read(&character);</pre>
Notes	None.

Cf_Fat_Rewrite

Prototype	<code>void Cf_Fat_Rewrite();</code>
Description	Opens currently assigned file for writing. If the file is not empty its content will be erased.
Parameters	None.
Returns	Nothing.
Requires	CF card and CF library must be initialized for file operations. See <code>Cf_Fat_Init</code> . The file must be previously assigned. See <code>Cf_Fat_Assign</code> .
Example	<pre>// open file for writing Cf_Fat_Rewrite();</pre>
Notes	None.

Cf_Fat_Append

Prototype	<code>void Cf_Fat_Append();</code>
Description	Opens currently assigned file for appending. Upon this function execution file pointers will be positioned after the last byte in the file, so any subsequent file writing operation will start from there.
Parameters	None.
Returns	Nothing.
Requires	CF card and CF library must be initialized for file operations. See <code>Cf_Fat_Init</code> . File must be previously assigned. See <code>Cf_Fat_Assign</code> .
Example	<pre>// open file for appending Cf_Fat_Append();</pre>
Notes	None.

Cf_Fat_Delete

Prototype	<code>void Cf_Fat_Delete();</code>
Description	Deletes currently assigned file from CF card.
Parameters	None.
Returns	Nothing.
Requires	CF card and CF library must be initialized for file operations. See <code>Cf_Fat_Init</code> . File must be previously assigned. See <code>Cf_Fat_Assign</code> .
Example	<pre>// delete current file Cf_Fat_Delete();</pre>
Notes	None.

Cf_Fat_Write

Prototype	<code>void Cf_Fat_Write(char *fdata, unsigned data_len);</code>
Description	Writes requested number of bytes to currently assigned file opened for writing.
Parameters	- <code>fdata</code> : data to be written. - <code>data_len</code> : number of bytes to be written.
Returns	Nothing.
Requires	CF card and CF library must be initialized for file operations. See <code>Cf_Fat_Init</code> . File must be previously assigned. See <code>Cf_Fat_Assign</code> . File must be open for writing. See <code>Cf_Fat_Rewrite</code> or <code>Cf_Fat_Append</code> .
Example	<pre>char file_contents[42]; ... Cf_Fat_Write(file_contents, 42); // write data to the assigned file</pre>
Notes	None.

Cf_Fat_Set_File_Date

Prototype	<code>void Cf_Fat_Set_File_Date(unsigned int year, unsigned short month, unsigned short day, unsigned short hours, unsigned short mins, unsigned short seconds);</code>
Description	Sets the date/time stamp. Any subsequent file writing operation will write this stamp to currently assigned file's time/date attributes.
Parameters	- <code>year</code> : year attribute. Valid values: 1980-2107 - <code>month</code> : month attribute. Valid values: 1-12 - <code>day</code> : day attribute. Valid values: 1-31 - <code>hours</code> : hours attribute. Valid values: 0-23 - <code>mins</code> : minutes attribute. Valid values: 0-59 - <code>seconds</code> : seconds attribute. Valid values: 0-59
Returns	Nothing.
Requires	CF card and CF library must be initialized for file operations. See <code>Cf_Fat_Init</code> . File must be previously assigned. See <code>Cf_Fat_Assign</code> . File must be open for writing. See <code>Cf_Fat_Rewrite</code> or <code>Cf_Fat_Append</code> .
Example	<pre>Cf_Fat_Set_File_Date(2005, 9, 30, 17, 41, 0);</pre>
Notes	None.

Cf_Fat_Get_File_Date

Prototype	<code>void Cf_Fat_Get_File_Date(unsigned int *year, unsigned short *month, unsigned short *day, unsigned short *hours, unsigned short *mins);</code>
Description	Reads time/date attributes of currently assigned file.
Parameters	<ul style="list-style-type: none"> - <code>year</code>: buffer to store year attribute to. Upon function execution year attribute is returned through this parameter. - <code>month</code>: buffer to store month attribute to. Upon function execution month attribute is returned through this parameter. - <code>day</code>: buffer to store day attribute to. Upon function execution day attribute is returned through this parameter. - <code>hours</code>: buffer to store hours attribute to. Upon function execution hours attribute is returned through this parameter. - <code>mins</code>: buffer to store minutes attribute to. Upon function execution minutes attribute is returned through this parameter.
Returns	Nothing.
Requires	CF card and CF library must be initialized for file operations. See Cf_Fat_Init. File must be previously assigned. See Cf_Fat_Assign.
Example	<pre>unsigned year; char month, day, hours, mins; ... Cf_Fat_Get_File_Date(&year, &month, &day, &hours, &mins);</pre>
Notes	None.

Cf_Fat_Get_File_Date_Modified

Prototype	<code>void Cf_Fat_Get_File_Date_Modified(unsigned int *year, unsigned short *month, unsigned short *day, unsigned short *hours, unsigned short *mins);</code>
Description	Retrieves the last modification date/time of the currently assigned file.
Parameters	<ul style="list-style-type: none"> - <code>year</code>: buffer to store year of modification attribute to. Upon function execution year of modification attribute is returned through this parameter. - <code>month</code>: buffer to store month of modification attribute to. Upon function execution month of modification attribute is returned through this parameter. - <code>day</code>: buffer to store day of modification attribute to. Upon function execution day of modification attribute is returned through this parameter. - <code>hours</code>: buffer to store hours of modification attribute to. Upon function execution hours of modification attribute is returned through this parameter. - <code>mins</code>: buffer to store minutes of modification attribute to. Upon function execution minutes of modification attribute is returned through this parameter.
Returns	Nothing.
Requires	CF card and CF library must be initialized for file operations. See Cf_Fat_Init. File must be previously assigned. See Cf_Fat_Assign.
Example	<pre>unsigned year; char month, day, hours, mins; ... Cf_Fat_Get_File_Date_Modified(&year, &month, &day, &hours, &mins);</pre>
Notes	None.

Cf_Fat_Get_File_Size

Prototype	<code>unsigned long Cf_Fat_Get_File_Size();</code>
Description	This function reads size of currently assigned file in bytes.
Parameters	None.
Returns	Size of the currently assigned file in bytes.
Requires	CF card and CF library must be initialized for file operations. See Cf_Fat_Init. File must be previously assigned. See Cf_Fat_Assign.
Example	<pre>unsigned long my_file_size; ... my_file_size = Cf_Fat_Get_File_Size();</pre>
Notes	None.

Cf_Fat_Get_Swap_File

Prototype	<code>unsigned long Cf_Fat_Get_Swap_File(unsigned long sectors_cnt, char *filename, char file_attr);</code>
Description	<p>This function is used to create a swap file of predefined name and size on the CF media. If a file with specified name already exists on the media, search for consecutive sectors will ignore sectors occupied by this file. Therefore, it is recommended to erase such file if it exists before calling this function. If it is not erased and there is still enough space for a new swap file, this function will delete it after allocating new memory space for a new swap file.</p> <p>The purpose of the swap file is to make reading and writing to CF media as fast as possible, by using the <code>Cf_Read_Sector()</code> and <code>Cf_Write_Sector()</code> functions directly, without potentially damaging the FAT system. Swap file can be considered as a “window” on the media where the user can freely write/read data. It’s main purpose in the this library is to be used for fast data acquisition; when the time-critical acquisition has finished, the data can be re-written into a “normal” file, and formatted in the most suitable way.</p>
Parameters	<ul style="list-style-type: none"> - <code>sectors_cnt</code>: number of consecutive sectors that user wants the swap file to have. - <code>filename</code>: name of the file that should be assigned for file operations. The file name should be in DOS 8.3 (file_name.extension) format. The file name and extension will be automatically padded with spaces by the library if they have less than length required (i.e. “mikro.tx” -> “mikro .tx “), so the user does not have to take care of that. The file name and extension are case insensitive. The library will convert them to proper case automatically, so the user does not have to take care of that. Also, in order to keep backward compatibility with the first version of this library, file names can be entered as UPPERCASE string of 11 bytes in length with no dot character between the file name and extension (i.e. “MIKROELETXT” -> MIKROELE.TXT). In this case the last 3 characters of the string are considered to be file extension. - <code>file_attr</code>: file creation and attributes flags. Each bit corresponds to the appropriate file attribute:

Parameters	Bit	Mask	Description
	0	0x01	Read Only
	1	0x02	Hidden
	2	0x04	System
	3	0x08	Volume Label
	4	0x10	Subdirectory
	5	0x20	Archive
	6	0x40	Device (internal use only, never found on disk)
	7	0x80	Not used
Returns	- Number of the start sector for the newly created swap file, if there was enough free space on CF card to create file of required size. - 0 - otherwise.		
Requires	CF card and CF library must be initialized for file operations. See Cf_Fat_Init.		
Example	<pre>//----- Try to create a swap file with archive attribute, whose size // will be at least 1000 sectors. // If it succeeds, it sends the No. of start sector over // UART unsigned long size; ... size = Cf_Fat_Get_Swap_File(1000, "mikroE.txt", 0x20); if (size) { UART1_Write(0xAA); UART1_Write(Lo(size)); UART1_Write(Hi(size)); UART1_Write(Higher(size)); UART1_Write(Highest(size)); UART1_Write(0xAA); }</pre>		
Notes	Long File Names (LFN) are not supported.		

Library Example

The following example writes 512 bytes at sector no.620, and then reads the data and sends it over UART1 for a visual check. Hardware configurations in this example are made for the dsPICPRO2 board and dsPIC30F6014A.

Copy Code To Clipboard

```
// set compact flash pinout
char Cf_Data_Port at PORTF;

sbit CF_RDY at RD7_bit;
sbit CF_WE at RD6_bit;
sbit CF_OE at RD5_bit;
sbit CF_CD1 at RD4_bit;
sbit CF_CE1 at RD3_bit;
sbit CF_A2 at RD2_bit;
sbit CF_A1 at RD1_bit;
sbit CF_A0 at RD0_bit;

sbit CF_RDY_direction at TRISD7_bit;
sbit CF_WE_direction at TRISD6_bit;
sbit CF_OE_direction at TRISD5_bit;
sbit CF_CD1_direction at TRISD4_bit;
sbit CF_CE1_direction at TRISD3_bit;
sbit CF_A2_direction at TRISD2_bit;
sbit CF_A1_direction at TRISD1_bit;
sbit CF_A0_direction at TRISD0_bit;
// end of cf pinout

char SignalPort at PORTB;
char SignalPort_direction at TRISB;

void InitCF() {
    CF_CD1_direction = 1;
    while (Cf_Detect() == 0) // wait until CF card is inserted
        ;
    Cf_Init(); // initialize CF
    while (!CF_RDY)
        ;
    Delay_ms(2000); // wait for a while until the card is stabilized
} // period depends on used CF card

void TestBytes() {
    unsigned int i;

    ///// Write numbers 0..511 to sector 590
    Cf_Write_Init(590,1); // Initialize write at sector address 590
                          // for 1 sector
    SignalPort = 0x03; // Notify that write has started
    Delay_ms(1000);
    for (i=0; i<=511; i++) // Write 512 bytes to sector 590
        Cf_Write_Byte(i);
}
```

```

SignalPort = 0x03; // Notify that write has started
Delay_ms(1000);
for (i=0; i<=511; i++) // Write 512 bytes to sector 590
    Cf_Write_Byte(i);

SignalPort = 0x07; // Notify that write end and read start
Delay_ms(1000);

Cf_Read_Init(590,1); // Initialize read from sector address 590
// for 1 sector
for (i=0; i<=511; i++) { // Read 512 bytes from sector address 590
    SignalPort = Cf_Read_Byte(); // Read one byte at time and display
// readings on signal port
    Delay_ms(5); // Wait for a while to see results
}
Delay_ms(1000);

///// Write numbers 511..0 to sector 590
Cf_Write_Init(590,1); // Initialize write at sector address 590
// for 1 sector
SignalPort = 0x03; // Notify that write has started
Delay_ms(1000);
for (i=0; i<=511; i++) // Write 512 bytes to sector 590
    Cf_Write_Byte(511-i);

SignalPort = 0x07; // Notify that write end and read start
Delay_ms(1000);

Cf_Read_Init(590,1); // Initialize read from sector address 590
// for 1 sector
for (i=0; i<=511; i++) { // Read 512 bytes from sector address 590
    SignalPort = Cf_Read_Byte(); // Read one byte at time and display
// readings on signal port
    Delay_ms(5); // Wait for a while to see results
}
Delay_ms(1000);
}

// Main program
void main() {

    ADPCFG = 0xFFFF; // disable A/D inputs

    SignalPort_direction = 0; // designate PORTC as output
    SignalPort = 0x01; // Notify test start
    InitCF();

    TestBytes();
    SignalPort = 0x0F; // Notify test end
}

```

HW Connection

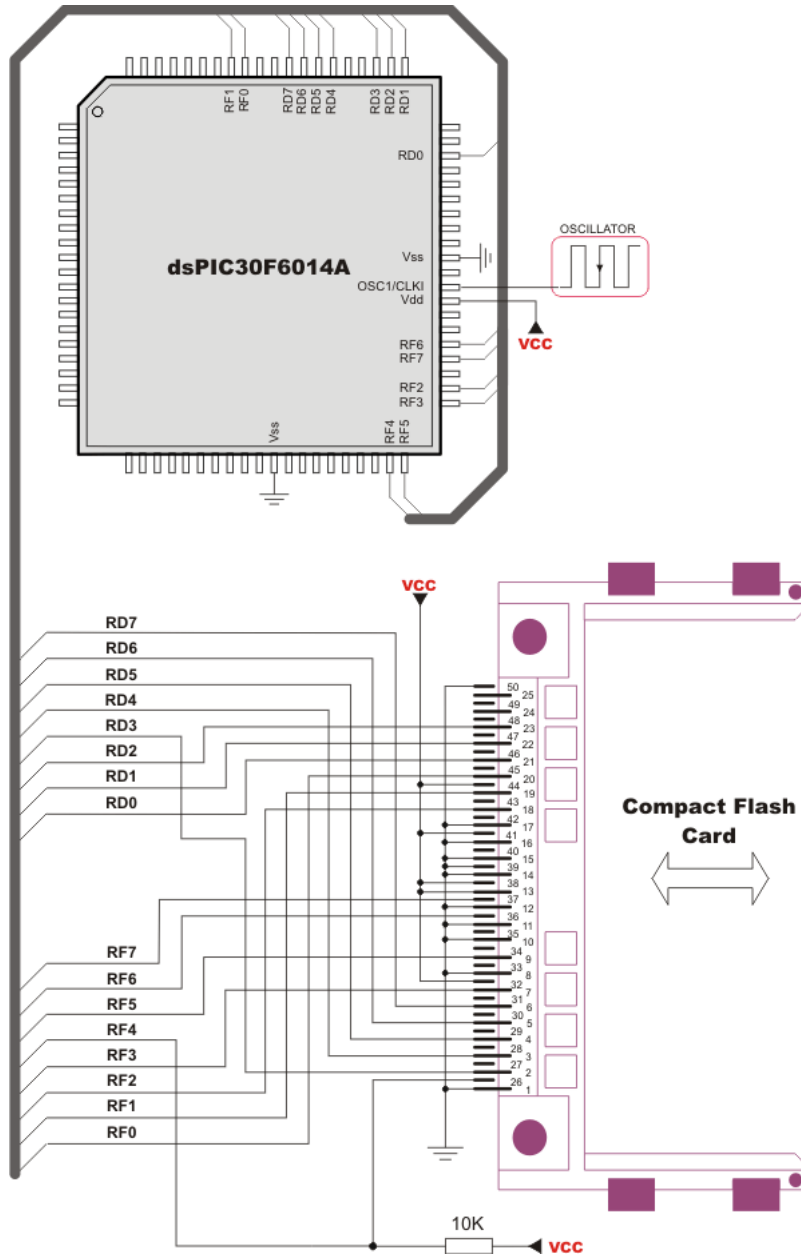

Pin diagram of CF memory card

ECAN Library

The mikroC PRO for dsPIC30/33 and PIC24 provides a library (driver) for working with the dsPIC33FJ and pic24HJ ECAN module.

ECAN is a very robust protocol that has error detection and signalling, self-checking and fault confinement. Faulty ECAN data and remote frames are re-transmitted automatically, similar to the Ethernet.

Data transfer rates depend on distance. For example, 1 Mbit/s can be achieved at network lengths below 40m while 250 Kbit/s can be achieved at network lengths below 250m. The greater distance the lower maximum bitrate that can be achieved. The lowest bitrate defined by the standard is 200Kbit/s. Cables used are shielded twisted pairs.

ECAN supports two message formats:

- Standard format, with 11 identifier bits, and
- Extended format, with 29 identifier bits

ECAN message format and DMA RAM buffer definition can be found in the `ECan_Defs.h` header file located in the ECAN project folder. Read this file carefully and make appropriate adjustments for mcu in use. Also, if a new project is to be created this file has to be copied, adjusted and included into the project via include pragma directive with corresponding Search Path updating.

Important :

ECAN buffers are located in DMA RAM, so two DMA channels are used for message transfer, one for each direction (ECAN->DMA RAM, DMA RAM->ECAN). See the `ECANxDmaChannellnit` routine.

Consult CAN standard about CAN bus termination resistance.

CAN library routines require you to specify the module you want to use. To select the desired CAN module, simply change the letter **x** in the routine prototype for a number from **1** to **2**.

Number of CAN modules per MCU differs from chip to chip. Please, read the appropriate datasheet before utilizing this library.

Library Routines

- `ECANxDmaChannellnit`
- `ECANxSetOperationMode`
- `ECANxGetOperationMode`
- `ECANxInitialize`
- `ECANxSelectTxBuffers`
- `ECANxFilterDisable`
- `ECANxFilterEnable`
- `ECANxSetBufferSize`
- `ECANxSetBaudRate`
- `ECANxSetMask`
- `ECANxSetFilter`
- `ECANxRead`
- `ECANxWrite`

ECANxDmaChannelInit

Prototype	<code>unsigned ECANxDmaChannelInit(unsigned DmaChannel, unsigned ChannelDir, void *DmaRamBuffAdd);</code>
Description	The function preforms initialization of the DMA module for ECAN.
Parameters	<ul style="list-style-type: none"> - <code>DmaChannel</code>: DMA Channel number. Valid values: 0..7. - <code>ChannelDir</code>: transfer direction. Valid values: 1 (DMA RAM to peripheral) and 0 (peripheral to DMA RAM). - <code>DmaRamBuffAdd</code>: DMA RAM buffer address. DMA RAM location is MCU dependent, refer to datasheet for valid address range.
Returns	<ul style="list-style-type: none"> - 0 - if DMA channel parameter is valid - 0x0001 - if DMA channel is already in use (busy) - 0xFFFF - if DMA channel parameter is invalid
Requires	<p>The ECAN routines are supported only by MCUs with the ECAN module.</p> <p>Microcontroller must be connected to ECAN transceiver which is connected to the ECAN bus.</p>
Example	<pre>// channel 0 will transfer 8 words from DMA RAM at 0x4000 to ECAN1 ECAN1DmaChannelInit(0, 1, 0x4000);</pre>
Notes	<ul style="list-style-type: none"> - ECAN library routine require you to specify the module you want to use. To select the desired ECAN module, simply change the letter x in the routine prototype for a number from 1 to 2. - Number of ECAN modules per MCU differs from chip to chip. Please, read the appropriate datasheet before utilizing this library.

ECANxSetOperationMode

Prototype	<code>void ECANxSetOperationMode(unsigned int mode, unsigned int WAIT);</code>
Description	Sets the ECAN module to requested mode.
Parameters	<ul style="list-style-type: none"> - <code>mode</code>: ECAN module operation mode. Valid values: <code>ECAN_OP_MODE</code> constants. See <code>ECAN_OP_MODE</code> constants. - <code>WAIT</code>: ECAN mode switching verification request. If <code>WAIT == 0</code>, the call is non-blocking. The function does not verify if the ECAN module is switched to requested mode or not. Caller must use <code>ECANxGetOperationMode</code> to verify correct operation mode before performing mode specific operation. If <code>WAIT != 0</code>, the call is blocking – the function won't "return" until the requested mode is set and no additional verification is necessary.
Returns	Nothing.
Requires	<p>The ECAN routines are supported only by MCUs with the ECAN module.</p> <p>Microcontroller must be connected to ECAN transceiver which is connected to the ECAN bus.</p>
Example	<pre>// set the ECAN1 module into configuration mode (wait inside ECAN1SetOperationMode until this mode is set) ECAN1SetOperationMode(_ECAN_MODE_CONFIG, 0xFF);</pre>
Notes	<ul style="list-style-type: none"> - ECAN library routine require you to specify the module you want to use. To select the desired ECAN module, simply change the letter x in the routine prototype for a number from 1 to 2. - Number of ECAN modules per MCU differs from chip to chip. Please, read the appropriate datasheet before utilizing this library.

ECANxGetOperationMode

Prototype	<code>unsigned int ECANxGetOperationMode();</code>
Description	The function returns current operation mode of the ECAN module. See <code>ECAN_OP_MODE</code> constants or device datasheet for operation mode codes.
Parameters	None.
Returns	Current operation mode.
Requires	The ECAN routines are supported only by MCUs with the ECAN module. Microcontroller must be connected to ECAN transceiver which is connected to the ECAN bus.
Example	<pre>// check whether the ECAN1 module is in Normal mode and if it is do something. if (ECAN1GetOperationMode() == _ECAN_MODE_NORMAL) { ... }</pre>
Notes	<ul style="list-style-type: none"> - ECAN library routine require you to specify the module you want to use. To select the desired ECAN module, simply change the letter x in the routine prototype for a number from 1 to 2. - Number of ECAN modules per MCU differs from chip to chip. Please, read the appropriate datasheet before utilizing this library.

ECANxInitialize

Prototype	<code>void ECANxInitialize(unsigned int SJW, unsigned int BRP, unsigned int PHSEG1, unsigned int PHSEG2, unsigned int PROPSEG, unsigned int ECAN_CONFIG_FLAGS);</code>
Description	<p>Initializes the ECAN module.</p> <p>The internal ECAN module is set to:</p> <ul style="list-style-type: none"> - Disable ECAN capture - Continue ECAN operation in Idle mode - Abort all pending transmissions - Clear all transmit control registers - Fcan clock : Fcy (Fosc/2) - Baud rate is set according to given parameters - ECAN mode is set to Normal - Filter and mask registers remain unchanged <p><code>SAM</code>, <code>SEG2PHTS</code>, <code>WAKFIL</code> and <code>DBEN</code> bits are set according to the <code>ECAN_CONFIG_FLAGS</code> value.</p>
Parameters	<ul style="list-style-type: none"> - <code>SJW</code> as defined in MCU's datasheet (ECAN Module) - <code>BRP</code> as defined in MCU's datasheet (ECAN Module) - <code>PHSEG1</code> as defined in MCU's datasheet (ECAN Module) - <code>PHSEG2</code> as defined in MCU's datasheet (ECAN Module) - <code>PROPSEG</code> as defined in MCU's datasheet (ECAN Module) - <code>ECAN_CONFIG_FLAGS</code> ECAN module configuration flags. Each bit corresponds to the appropriate ECAN module parameter. Should be formed out of predefined ECAN flag constants. See <code>ECAN_CONFIG_FLAGS</code> constants.
Returns	Nothing.
Requires	<p>The ECAN routines are supported only by MCUs with the ECAN module.</p> <p>Microcontroller must be connected to ECAN transceiver which is connected to the ECAN bus.</p>
Example	<pre>// initialize the ECAN1 module with appropriate baud rate and message // acceptance flags along with the sampling rules unsigned int ecan_config_flags; ... ecan_config_flags = _ECAN_CONFIG_SAMPLE_THRICE & // Form value to be used _ECAN_CONFIG_PHSEG2_PRG_ON & // with ECANInitialize _ECAN_CONFIG_XTD_MSG & _ECAN_CONFIG_MATCH_MSG_TYPE & _ECAN_CONFIG_LINE_FILTER_OFF; ECAN1Initialize(1, 3, 3, 3, 1, ecan_config_flags); // initialize the ECAN1 module</pre>
Notes	<ul style="list-style-type: none"> - ECAN mode NORMAL will be set on exit. - ECAN library routine require you to specify the module you want to use. To select the desired ECAN module, simply change the letter x in the routine prototype for a number from 1 to 2. - Number of ECAN modules per MCU differs from chip to chip. Please, read the appropriate datasheet before utilizing this library.

ECANxSelectTxBuffers

Prototype	<code>unsigned ECANxSelectTxBuffers(unsigned txselect);</code>
Description	The function designates the ECAN module's transmit buffers.
Parameters	- <code>txselect</code> : transmit buffer select. By setting bits in the <code>txselect</code> lower byte corresponding buffers are enabled for transmission. The ECAN module supports up to 8 transmit buffers. Also, by clearing bits in the <code>txselect</code> lower byte corresponding buffers are enabled for reception.
Returns	- 0 - if input parameter is valid - 0xFFFF - if input parameter is invalid
Requires	The ECAN routines are supported only by MCUs with the ECAN module. Microcontroller must be connected to ECAN transceiver which is connected to the ECAN bus. The ECAN module must be initialized. See the ECANxInitialize routine.
Example	<pre>// Buffers 0 and 2 are enabled for transmission: ECAN1SelectTxBuffers(0x0005);</pre>
Notes	- ECAN library routine require you to specify the module you want to use. To select the desired ECAN module, simply change the letter x in the routine prototype for a number from 1 to 2 . - Number of ECAN modules per MCU differs from chip to chip. Please, read the appropriate datasheet before utilizing this library.

ECANxFilterDisable

Prototype	<code>void ECANxFilterDisable(unsigned fltdis);</code>
Description	The function disables receive filters.
Parameters	- <code>fltdis</code> : filter disable selection parameter. Each bit corresponds to appropriate filter. By setting bit the corresponding filter is to be disabled.
Returns	Nothing.
Requires	The ECAN routines are supported only by MCUs with the ECAN module. Microcontroller must be connected to ECAN transceiver which is connected to the ECAN bus. The ECAN module must be initialized. See the ECANxInitialize routine.
Example	<pre>// Buffers 0 and 2 are enabled for transmission: ECAN1SelectTxBuffers(0x0005);</pre>
Notes	- ECAN library routine require you to specify the module you want to use. To select the desired ECAN module, simply change the letter x in the routine prototype for a number from 1 to 2 . - Number of ECAN modules per MCU differs from chip to chip. Please, read the appropriate datasheet before utilizing this library.

ECANxFilterEnable

Prototype	<code>void ECANxFilterEnable(unsigned flten);</code>
Description	The function enables receive filters.
Parameters	- <code>flten</code> : filter enable selection parameter. Each bit corresponds to appropriate filter. By setting bit the corresponding filter will be enabled.
Returns	Nothing.
Requires	The ECAN routines are supported only by MCUs with the ECAN module. Microcontroller must be connected to ECAN transceiver which is connected to the ECAN bus. The ECAN module must be initialized. See the ECANxInitialize routine.
Example	<pre>// Filters 0, 4, 8, 12 are to be enabled: ECAN1FilterEnable(0x1111);</pre>
Notes	- ECAN library routine require you to specify the module you want to use. To select the desired ECAN module, simply change the letter x in the routine prototype for a number from 1 to 2 . - Number of ECAN modules per MCU differs from chip to chip. Please, read the appropriate datasheet before utilizing this library.

ECANxSetBufferSize

Prototype	<code>unsigned ECANxSetBufferSize(unsigned Ecan1BuffSize);</code>
Description	The function configures the total number of receive and transmit buffers in DMA RAM.
Parameters	- <code>Ecan1BuffSize</code> : Number of ECAN DMA RAM receive and transmit buffers. Valid values: 4, 6, 8, 12, 16, 24, 32. Each buffer is 16 bytes long.
Returns	- <code>0</code> - if input parameter is valid - <code>0xFFFF</code> - if input parameter is invalid
Requires	The ECAN routines are supported only by MCUs with the ECAN module. Microcontroller must be connected to ECAN transceiver which is connected to the ECAN bus. The ECAN module must be initialized. See the ECANxInitialize routine.
Example	<pre>// DMA RAM will have 16 rx+tx buffers ECAN1SetBufferSize(16);</pre>
Notes	- The same value should be used for DMA RAM buffer definition in the ECan_Defs.h header file located in the ECAN project folder. - ECAN library routine require you to specify the module you want to use. To select the desired ECAN module, simply change the letter x in the routine prototype for a number from 1 to 2 . - Number of ECAN modules per MCU differs from chip to chip. Please, read the appropriate datasheet before utilizing this library.

ECANxSetBaudRate

Prototype	<code>void ECANxSetBaudRate(unsigned int SJW, unsigned int BRP, unsigned int PHSEG1, unsigned int PHSEG2, unsigned int PROPSEG, unsigned int ECAN_CONFIG_FLAGS);</code>
Description	Sets ECAN module baud rate. Due to complexity of the ECAN protocol, you can not simply force the bps value. Instead, use this function when ECAN is in Config mode. Refer to datasheet for details. <code>SAM</code> , <code>SEG2PHTS</code> and <code>WAKFIL</code> bits are set according to the <code>ECAN_CONFIG_FLAGS</code> value.
Parameters	<ul style="list-style-type: none"> - <code>SJW</code> as defined in MCU's datasheet (ECAN Module) - <code>BRP</code> as defined in MCU's datasheet (ECAN Module) - <code>PHSEG1</code> as defined in MCU's datasheet (ECAN Module) - <code>PHSEG2</code> as defined in MCU's datasheet (ECAN Module) - <code>PROPSEG</code> as defined in MCU's datasheet (ECAN Module) - <code>ECAN_CONFIG_FLAGS</code> ECAN module configuration flags. Each bit corresponds to the appropriate ECAN module parameter. Should be formed out of predefined ECAN flag constants. See <code>ECAN_CONFIG_FLAGS</code> constants
Returns	Nothing.
Requires	<p>The ECAN routines are supported only by MCUs with the ECAN module.</p> <p>Microcontroller must be connected to ECAN transceiver which is connected to the ECAN bus.</p> <p>The ECAN module must be in Config mode, otherwise the function will be ignored. See <code>ECANxSetOperationMode</code>.</p>
Example	<pre>// set required baud rate and sampling rules unsigned int ecan_config_flags; ... ECAN1SetOperationMode(_ECAN_MODE_CONFIG, 0xFF); // set CONFIGURATION mode (ECAN1 module must be in config mode for baud rate settings) ecan_config_flags = _ECAN_CONFIG_SAMPLE_THRICE & // Form value to be used _ECAN_CONFIG_PHSEG2_PRG_ON & // with ECAN1SetBaudRate _ECAN_CONFIG_XTD_MSG & _ECAN_CONFIG_MATCH_MSG_TYPE & _ECAN_CONFIG_LINE_FILTER_OFF; ECAN1SetBaudRate(1, 3, 3, 3, 1, ecan_config_flags); // set ECAN1 module baud rate</pre>
Notes	<ul style="list-style-type: none"> - ECAN library routine require you to specify the module you want to use. To select the desired ECAN module, simply change the letter <code>x</code> in the routine prototype for a number from <code>1</code> to <code>2</code>. - Number of ECAN modules per MCU differs from chip to chip. Please, read the appropriate datasheet before utilizing this library.

ECANxSetMask

Prototype	<code>void ECANxSetMask(unsigned int ECAN_MASK, long val, unsigned int ECAN_CONFIG_FLAGS);</code>
Description	The function configures appropriate mask for advanced message filtering.
Parameters	<ul style="list-style-type: none"> - <code>ECAN_MASK</code>: ECAN module mask number. Valid values: <code>ECAN_MASK</code> constants. See <code>ECAN_MASK</code> constants. - <code>val</code>: mask register value. This value is bit-adjusted to appropriate buffer mask registers - <code>ECAN_CONFIG_FLAGS</code>: selects type of messages to filter. Valid values: <ul style="list-style-type: none"> - <code>ECAN_CONFIG_ALL_VALID_MSG</code>, - <code>ECAN_CONFIG_MATCH_MSG_TYPE & ECAN_CONFIG_STD_MSG</code>, - <code>ECAN_CONFIG_MATCH_MSG_TYPE & ECAN_CONFIG_XTD_MSG</code>. <p>See <code>ECAN_CONFIG_FLAGS</code> constants.</p>
Returns	Nothing.
Requires	<p>The ECAN routines are supported only by MCUs with the ECAN module.</p> <p>Microcontroller must be connected to ECAN transceiver which is connected to the ECAN bus.</p> <p>The ECAN module must be in Config mode, otherwise the function will be ignored. See <code>ECANxSetOperationMode</code>.</p>
Example	<pre>// set appropriate filter mask and message type value ECAN1SetOperationMode(_ECAN_MODE_CONFIG,0xFF); // set CONFIGURATION mode (ECAN1 module must be in config mode for mask settings) // Set all mask0 bits to 1 (all filtered bits are relevant): // Note that -1 is just a cheaper way to write 0xFFFFFFFF. // Complement will do the trick and fill it up with ones. ECAN1SetMask(_ECAN_MASK_0, -1, _ECAN_CONFIG_MATCH_MSG_TYPE & _ECAN_CONFIG_XTD_MSG);</pre>
Notes	<ul style="list-style-type: none"> - ECAN library routine require you to specify the module you want to use. To select the desired ECAN module, simply change the letter x in the routine prototype for a number from 1 to 2. - Number of ECAN modules per MCU differs from chip to chip. Please, read the appropriate datasheet before utilizing this library.

ECANxSetFilter

Prototype	<code>void ECANxSetFilter(unsigned int ECAN_FILTER, long val, unsigned int ECAN_FILTER_MASK, unsigned int ECAN_FILTER_RXBUFF, unsigned int ECAN_CONFIG_FLAGS);</code>
Description	The function configures and enables appropriate message filter.
Parameters	<ul style="list-style-type: none"> - <code>ECAN_FILTER</code>: ECAN module filter number. Valid values: <code>ECAN_FILTER</code> constants. See <code>ECAN_FILTER</code> constants. - <code>val</code>: filter register value. This value is bit-adjusted to appropriate filter registers - <code>ECAN_FILTER_MASK</code>: mask register corresponding to filter. Valid values: <code>ECAN_MASK</code> constants. See <code>ECAN_MASK</code> constants. - <code>ECAN_FILTER_RXBUFF</code>: receive buffer corresponding to filter. Valid values: <code>ECAN_RX_BUFFER</code> constants. See <code>ECAN_RX_BUFFER</code> constants. - <code>ECAN_CONFIG_FLAGS</code>: selects type of messages to filter. Valid values: <code>_ECAN_CONFIG_XTD_MSG</code> and <code>_ECAN_CONFIG_STD_MSG</code>. See <code>ECAN_CONFIG_FLAGS</code> constants.
Returns	Nothing.
Requires	<p>The ECAN routines are supported only by MCUs with the ECAN module.</p> <p>Microcontroller must be connected to ECAN transceiver which is connected to the ECAN bus.</p> <p>The ECAN module must be in Config mode, otherwise the function will be ignored. See <code>ECANxSetOperationMode</code>.</p>
Example	<pre>// set appropriate filter value and message type ECAN1SetOperationMode(_ECAN_MODE_CONFIG,0xFF); // set CONFIGURATION mode (ECAN1 module must be in config mode for filter settings) // Set id of filter 10 to 3, mask2, receive buffer 7, extended messages: ECAN1SetFilter(_ECAN_FILTER_10, 3, _ECAN_MASK_2, _ECAN_RX_BUFFER_7, _ECAN_CONFIG_XTD_MSG);</pre>
Notes	<p>ECAN library routine require you to specify the module you want to use. To select the desired ECAN module, simply change the letter x in the routine prototype for a number from 1 to 2.</p> <p>Number of ECAN modules per MCU differs from chip to chip. Please, read the appropriate datasheet before utilizing this library.</p>

ECANxRead

Prototype	<code>unsigned int ECANxRead(unsigned long *id, char *data, unsigned int *dataLen, unsigned int *ECAN_RX_MSG_FLAGS);</code>
Description	<p>If at least one full Receive Buffer is found, it will be processed in the following way:</p> <ul style="list-style-type: none"> - Message ID is retrieved and stored to location pointed by the <code>id</code> pointer - Message data is retrieved and stored to array pointed by the <code>data</code> pointer - Message length is retrieved and stored to location pointed by the <code>dataLen</code> pointer - Message flags are retrieved and stored to location pointed by the <code>ECAN_RX_MSG_FLAGS</code> pointer
Parameters	<ul style="list-style-type: none"> - <code>id</code>: message identifier address - <code>data</code>: an array of bytes up to 8 bytes in length - <code>dataLen</code>: data length address - <code>ECAN_RX_MSG_FLAGS</code>: message flags address. For message receive flags format refer to the <code>ECAN_RX_MSG_FLAGS</code> constants. See <code>ECAN_RX_MSG_FLAGS</code> constants.
Returns	<ul style="list-style-type: none"> - <code>0</code> if none of Receive Buffers is full - <code>0xFFFF</code> if at least one of Receive Buffers is full (message received)
Requires	<p>The ECAN routines are supported only by MCUs with the ECAN module.</p> <p>Microcontroller must be connected to ECAN transceiver which is connected to the ECAN bus.</p> <p>The ECAN module must be in a mode in which receiving is possible. See <code>ECANxSetOperationMode</code>.</p>
Example	<pre>// check the ECAN1 module for received messages. If any was received do something. unsigned int msg_rcvd, rx_flags, data_len; char data[8]; unsigned long msg_id; ... ECAN1SetOperationMode(_ECAN_MODE_NORMAL,0xFF); // set NORMAL mode (ECAN1 module must be in a mode in which receiving is possible) ... rx_flags = 0; // clear message flags if (msg_rcvd = ECAN1Read(&msg_id, data, &data_len, &rx_flags)) { ... }</pre>
Notes	<ul style="list-style-type: none"> - ECAN library routine require you to specify the module you want to use. To select the desired ECAN module, simply change the letter <code>x</code> in the routine prototype for a number from <code>1</code> to <code>2</code>. - Number of ECAN modules per MCU differs from chip to chip. Please, read the appropriate datasheet before utilizing this library.

ECANxWrite

Prototype	<code>unsigned int ECANxWrite(long id, char *Data, unsigned int DataLen, unsigned int ECAN_TX_MSG_FLAGS);</code>
Description	If at least one empty Transmit Buffer is found, the function sends message in the queue for transmission.
Parameters	<ul style="list-style-type: none"> - <code>id</code>: ECAN message identifier. Valid values: all 11 or 29 bit values, depending on message type (standard or extended) - <code>Data</code>: data to be sent - <code>DataLen</code>: data length. Valid values: 0..8 - <code>ECAN_TX_MSG_FLAGS</code>: message flags. Valid values: <code>ECAN_TX_MSG_FLAGS</code> constants. See <code>ECAN_TX_MSG_FLAGS</code> constants.
Returns	<ul style="list-style-type: none"> - 0 if all Transmit Buffers are busy - 0xFFFF if at least one Transmit Buffer is empty and available for transmission
Requires	<p>The ECAN routines are supported only by MCUs with the ECAN module.</p> <p>Microcontroller must be connected to ECAN transceiver which is connected to the ECAN bus.</p> <p>The ECAN module must be in a mode in which transmission is possible. See <code>ECANxSetOperationMode</code>.</p>
Example	<pre>// send message extended ECAN message with appropriate ID and data unsigned int tx_flags; char data[8]; unsigned long msg_id; ... ECAN1SetOperationMode(_ECAN_MODE_NORMAL,0xFF); // set NORMAL mode (ECAN1 must be in a mode in which transmission is possible) tx_flags = _ECAN_TX_PRIORITY_0 & _ECAN_TX_XTD_FRAME & _ECAN_TX_NO_RTR_FRAME; // set message flags ECAN1Write(msg_id, data, 1, tx_flags);</pre>
Notes	<ul style="list-style-type: none"> - ECAN library routine require you to specify the module you want to use. To select the desired ECAN module, simply change the letter x in the routine prototype for a number from 1 to 2. - Number of ECAN modules per MCU differs from chip to chip. Please, read the appropriate datasheet before utilizing this library.

ECAN Constants

There is a number of constants predefined in the ECAN library. You need to be familiar with them in order to be able to use the library effectively. Check the example at the end of the chapter.

ECAN_OP_MODE Constants

The `ECAN_OP_MODE` constants define ECAN operation mode. The routine `ECANxSetOperationMode` expect one of these as their argument:

Copy Code To Clipboard

```
const unsigned int
    _ECAN_MODE_BITS           = 0x00E0,    // Use this to access opmode bits
    _ECAN_MODE_NORMAL        = 0x00,
    _ECAN_MODE_DISABLE       = 0x01,
    _ECAN_MODE_LOOP          = 0x02,
    _ECAN_MODE_LISTEN        = 0x03,
    _ECAN_MODE_CONFIG        = 0x04,
    _ECAN_MODE_LISTEN_ALL    = 0x07;
```

ECAN_CONFIG_FLAGS Constants

The `ECAN_CONFIG_FLAGS` constants define flags related to the ECAN module configuration. The routines `ECANxInitialize` and `ECANxSetBaudRate` expect one of these (or a bitwise combination) as their argument:

Copy Code To Clipboard

```
const unsigned int
    _ECAN_CONFIG_DEFAULT      = 0xFF,    // 11111111

    _ECAN_CONFIG_PHSEG2_PRG_BIT = 0x01,
    _ECAN_CONFIG_PHSEG2_PRG_ON  = 0xFF,    // XXXXXXX1
    _ECAN_CONFIG_PHSEG2_PRG_OFF = 0xFE,    // XXXXXXX0

    _ECAN_CONFIG_LINE_FILTER_BIT = 0x02,
    _ECAN_CONFIG_LINE_FILTER_ON  = 0xFF,    // XXXXXX1X
    _ECAN_CONFIG_LINE_FILTER_OFF = 0xFD,    // XXXXXX0X

    _ECAN_CONFIG_SAMPLE_BIT     = 0x04,
    _ECAN_CONFIG_SAMPLE_ONCE    = 0xFF,    // XXXXX1XX
    _ECAN_CONFIG_SAMPLE_THRICE  = 0xFB,    // XXXXX0XX

    _ECAN_CONFIG_MSG_TYPE_BIT   = 0x08,
    _ECAN_CONFIG_STD_MSG        = 0xFF,    // XXXX1XXX
    _ECAN_CONFIG_XTD_MSG        = 0xF7,    // XXXX0XXX

    _ECAN_CONFIG_MATCH_TYPE_BIT = 0x20,
    _ECAN_CONFIG_ALL_VALID_MSG  = 0xDF,    // XX0XXXXX
    _ECAN_CONFIG_MATCH_MSG_TYPE = 0xFF;    // XX1XXXXX
```

You may use bitwise AND (&) to form config word out of these values. For example:

Copy Code To Clipboard

```
init = _ECAN_CONFIG_SAMPLE_THRICE &
       _ECAN_CONFIG_PHSEG2_PRG_ON &
       _ECAN_CONFIG_STD_MSG      &
       _ECAN_CONFIG_MATCH_MSG_TYPE &
       _ECAN_CONFIG_LINE_FILTER_OFF;
...
ECAN1Initialize(1, 1, 3, 3, 1, init); // initialize ECAN1
```

ECAN_TX_MSG_FLAGS Constants

ECAN_TX_MSG_FLAGS are flags related to transmission of ECAN message. The routine ECANxWrite expect one of these (or a bitwise combination) as their argument:

Copy Code To Clipboard

```
const unsigned int
    _ECAN_TX_PRIORITY_BITS = 0x03,
    _ECAN_TX_PRIORITY_0   = 0xFC, // XXXXXX00
    _ECAN_TX_PRIORITY_1   = 0xFD, // XXXXXX01
    _ECAN_TX_PRIORITY_2   = 0xFE, // XXXXXX10
    _ECAN_TX_PRIORITY_3   = 0xFF, // XXXXXX11

    _ECAN_TX_FRAME_BIT    = 0x08,
    _ECAN_TX_STD_FRAME    = 0xFF, // XXXXX1XX
    _ECAN_TX_XTD_FRAME    = 0xF7, // XXXXX0XX

    _ECAN_TX_RTR_BIT      = 0x40,
    _ECAN_TX_NO_RTR_FRAME = 0xFF, // X1XXXXXX
    _ECAN_TX_RTR_FRAME    = 0xBF; // X0XXXXXX
```

You may use bitwise AND (&) to adjust the appropriate flags. For example:

Copy Code To Clipboard

```
// form value to be used with CANSendMessage:
send_config = _ECAN_TX_PRIORITY_0 &
              _ECAN_TX_XTD_FRAME &
              _ECAN_TX_NO_RTR_FRAME;
...
ECAN1SendMessage(id, data, 1, send_config);
```

ECAN_RX_MSG_FLAGS Constants

ECAN_RX_MSG_FLAGS are flags related to reception of ECAN message. If a particular bit is set then corresponding meaning is TRUE or else it will be FALSE.

Copy Code To Clipboard

```
const unsigned int
    _ECAN_RX_FILTER_BITS = 0x000F, // Use this to access filter bits
    _ECAN_RX_FILTER_0   = 0x00,   // filter0 match
    _ECAN_RX_FILTER_1   = 0x01,   // filter1 match
    _ECAN_RX_FILTER_2   = 0x02,   // ...
    _ECAN_RX_FILTER_3   = 0x03,
    _ECAN_RX_FILTER_4   = 0x04,
    _ECAN_RX_FILTER_5   = 0x05,
    _ECAN_RX_FILTER_6   = 0x06,
    _ECAN_RX_FILTER_7   = 0x07,
    _ECAN_RX_FILTER_8   = 0x08,
    _ECAN_RX_FILTER_9   = 0x09,
    _ECAN_RX_FILTER_10  = 0x0A,
    _ECAN_RX_FILTER_11  = 0x0B,
    _ECAN_RX_FILTER_12  = 0x0C,
    _ECAN_RX_FILTER_13  = 0x0D,
    _ECAN_RX_FILTER_14  = 0x0E,   // ...
    _ECAN_RX_FILTER_15  = 0x0F,   // filter15 match

    _ECAN_RX_OVERFLOW   = 0x10,   // Set if Overflowed else cleared
    _ECAN_RX_INVALID_MSG = 0x20,   // Set if invalid else cleared
    _ECAN_RX_XTD_FRAME  = 0x40,   // Set if XTD message else cleared
    _ECAN_RX_RTR_FRAME  = 0x80;   // Set if RTR message else cleared
```

You may use bitwise AND (&) to extract received message status. For example:

Copy Code To Clipboard

```
if (MsgFlag & _ECAN_RX_OVERFLOW != 0) {
    ...
    // Receiver overflow has occurred.
    // We have lost our previous message.
}
```

ECAN_MASK Constants

The `ECAN_MASK` constants define mask codes. The routine `ECANxSetMask` expect one of these as their argument:

Copy Code To Clipboard

```
const unsigned int
    _ECAN_MASK_0 = 0,
    _ECAN_MASK_1 = 1,
    _ECAN_MASK_2 = 2;
```

ECAN_FILTER Constants

The `ECAN_FILTER` constants define filter codes. The routine `ECANxSetFilter` expect one of these as their argument:

Copy Code To Clipboard

```
const unsigned int
    _ECAN_FILTER_0 = 0,
    _ECAN_FILTER_1 = 1,
    _ECAN_FILTER_2 = 2,
    _ECAN_FILTER_3 = 3,
    _ECAN_FILTER_4 = 4,
    _ECAN_FILTER_5 = 5,
    _ECAN_FILTER_6 = 6,
    _ECAN_FILTER_7 = 7,
    _ECAN_FILTER_8 = 8,
    _ECAN_FILTER_9 = 9,
    _ECAN_FILTER_10 = 10,
    _ECAN_FILTER_11 = 11,
    _ECAN_FILTER_12 = 12,
    _ECAN_FILTER_13 = 13,
    _ECAN_FILTER_14 = 14,
    _ECAN_FILTER_15 = 15;
```

ECAN_RX_BUFFER Constants

The `ECAN_RX_BUFFER` constants define RX bufer codes codes. The routine `ECANxSetFilter` expect one of these as their argument:

Copy Code To Clipboard

```
const unsigned int
    _ECAN_RX_BUFFER_0 = 0,
    _ECAN_RX_BUFFER_1 = 1,
    _ECAN_RX_BUFFER_2 = 2,
    _ECAN_RX_BUFFER_3 = 3,
    _ECAN_RX_BUFFER_4 = 4,
    _ECAN_RX_BUFFER_5 = 5,
    _ECAN_RX_BUFFER_6 = 6,
    _ECAN_RX_BUFFER_7 = 7,
    _ECAN_RX_BUFFER_8 = 8,
    _ECAN_RX_BUFFER_9 = 9,
    _ECAN_RX_BUFFER_10 = 10,
    _ECAN_RX_BUFFER_11 = 11,
    _ECAN_RX_BUFFER_12 = 12,
    _ECAN_RX_BUFFER_13 = 13,
    _ECAN_RX_BUFFER_14 = 14,
    _ECAN_RX_BUFFER_15 = 15;
```

Library Example

The example demonstrates ECAN protocol. The 1st node initiates the communication with the 2nd node by sending some data to its address. The 2nd node responds by sending back the data incremented by 1. The 1st node then does the same and sends incremented data back to the 2nd node, etc.

Code for the first ECAN node:

Copy Code To Clipboard

```
#include "ECAN_Defs.h"

unsigned int Can_Init_Flags, Can_Send_Flags, Can_Rcv_Flags; // can flags
unsigned int Rx_Data_Len; // received data length in bytes
char RxTx_Data[8]; // can rx/tx data buffer
char Msg_Rcvd; // reception flag
unsigned long Tx_ID, Rx_ID; // can rx and tx ID

void C1Interrupt(void) org 0x005A { // ECAN event interrupt
    IFS2bits.C1IF = 0; // clear ECAN interrupt flag
    if(C1INTFbits.TBIF) { // was it tx interrupt?
        C1INTFbits.TBIF = 0; // if yes clear tx interrupt flag
    }

    if(C1INTFbits.RBIF) { // was it rx interrupt?
        C1INTFbits.RBIF = 0; // if yes clear rx interrupt flag
    }
}

void main() {

    // Set PLL : Fosc = ((Fin/PLLPRE)*PLLDIV)/PLLPOST ; (((10MHz/2)*32)/4) = 20MHz
    // refer the pic24 family datasheet for more details
    CLKDIV &= 0xFFE0; //CLKDIVbits.PLLPRE = 0;
    PLLFBD = 0x1E; //PLLFBDbits.PLLDIV = 0x1E;
    CLKDIV &= 0xFF3F; //CLKDIVbits.PLLPOST = 1;
    CLKDIV |= 0x00C0;

    AD1PCFGH = 0xFFFF; //
    AD1PCFGL = 0xFFFF; // all ports digital I/O
    AD2PCFGL = 0xFFFF; //

    /* Clear Interrupt Flags */

    IFS0=0;
    IFS1=0;
    IFS2=0;
    IFS3=0;
    IFS4=0;

    /* Enable ECAN1 Interrupt */
```

```

IEC2bits.C1IE    = 1;           // enable ECAN1 interrupts
ClINTEbits.TBIE = 1;           // enable ECAN1 tx interrupt
ClINTEbits.RBIE = 1;           // enable ECAN1 rx interrupt

PORTB = 0;           // clear PORTB
TRISB = 0;           // set PORTB as output,
                       // for received message data
displaying

Can_Init_Flags = 0;           //
Can_Send_Flags = 0;           // clear flags
Can_Rcv_Flags  = 0;           //

Can_Send_Flags = _ECAN_TX_PRIORITY_0 &           // Form value to be used
                 _ECAN_TX_XTD_FRAME &           // with CANSendMessage
                 _ECAN_TX_NO_RTR_FRAME;

Can_Init_Flags = _ECAN_CONFIG_SAMPLE_THRICE &    // Form value to be used
                 _ECAN_CONFIG_PHSEG2_PRG_ON &    // with CANInitialize
                 _ECAN_CONFIG_XTD_MSG &
                 _ECAN_CONFIG_MATCH_MSG_TYPE &
                 _ECAN_CONFIG_LINE_FILTER_OFF;

RxTx_Data[0] = 9;           // set initial data to be sent
ECAN1DmaChannelInit(0, 1, &ECAN1RxTxRAMBuffer); // init dma channel 0 for
// dma to ECAN peripheral transfer
ECAN1DmaChannelInit(2, 0, &ECAN1RxTxRAMBuffer); // init dma channel 2 for
// ECAN peripheral to dma transfer
ECAN1Initialize(1, 3, 3, 3, 1, Can_Init_Flags); // initialize ECAN
ECAN1SetBufferSize(ECAN1RAMBUFFERSIZE);         // set number of rx+tx buffers in
DMA RAM

ECAN1SelectTxBuffers(0x000F);           // select transmit buffers
// 0x000F = buffers 0:3 are transmit buffers
ECAN1SetOperationMode(_ECAN_MODE_CONFIG,0xFF); // set CONFIGURATION mode

ECAN1SetMask(_ECAN_MASK_0, -1, _ECAN_CONFIG_MATCH_MSG_TYPE & _ECAN_CONFIG_XTD_MSG);
// set all mask1 bits to ones
ECAN1SetMask(_ECAN_MASK_1, -1, _ECAN_CONFIG_MATCH_MSG_TYPE & _ECAN_CONFIG_XTD_MSG);
// set all mask2 bits to ones
ECAN1SetMask(_ECAN_MASK_2, -1, _ECAN_CONFIG_MATCH_MSG_TYPE & _ECAN_CONFIG_XTD_MSG);
// set all mask3 bits to ones
ECAN1SetFilter(_ECAN_FILTER_10, 3, _ECAN_MASK_2, _ECAN_RX_BUFFER_7, _ECAN_CONFIG_XTD_
MSG); // set id of filter10 to 3,
//
assign mask2 to filter10
//
assign buffer7 to filter10
ECAN1SetOperationMode(_ECAN_MODE_NORMAL, 0xFF); // set NORMAL mode

Tx_ID = 12111;           // set transmit ID

```

```
ECAN1Write(Tx_ID, RxTx_Data, 1, Can_Send_Flags);          // send initial message

while (1) {                                             // endless loop
    Msg_Rcvd = ECAN1Read(&Rx_ID , RxTx_Data , &Rx_Data_Len, &Can_Rcv_Flags); // receive
message
    if ((Rx_ID == 3u) && Msg_Rcvd) {                    // if message received check id
        PORTB = RxTx_Data[0];                          // id correct, output data at PORTB
        RxTx_Data[0]++;                                // increment received data
        Delay_ms(10);
        ECAN1Write(Tx_ID, RxTx_Data, 1, Can_Send_Flags); // send incremented data back
    }
}
}
```

Code for the second ECAN node:

Copy Code To Clipboard

```
#include "__Lib_ECAN1_Defs.h"

unsigned int Can_Init_Flags, Can_Send_Flags, Can_Rcv_Flags; // can flags
unsigned int Rx_Data_Len;                                   // received data length in
bytes
char RxTx_Data[8];                                        // can rx/tx data buffer
char Msg_Rcvd;                                           // reception flag
unsigned long Tx_ID, Rx_ID;                               // can rx and tx ID

void C1Interrupt(void) org 0x005A {                       // ECAN event interrupt
    IFS2bits.C1IF = 0;                                    // clear ECAN interrupt flag
    if(C1INTFbits.TBIF) {                                  // was it tx interrupt?
        C1INTFbits.TBIF = 0;                              // if yes clear tx interrupt flag
    }

    if(C1INTFbits.RBIF) {                                  // was it rx interrupt?
        C1INTFbits.RBIF = 0;                              // if yes clear rx interrupt flag
    }
}

void main() {

    // Set PLL : Fosc = ((Fin/PLLPRE)*PLLDIV)/PLLPOST ; (((10MHz/2)*32)/4) = 20MHz
    // refer the pic24 family datasheet for more details
    CLKDIV &= 0xFFE0; //CLKDIVbits.PLLPRE = 0;
    PLLFBD = 0x1E; //PLLFBDbits.PLLDIV = 0x1E;
    CLKDIV &= 0xFF3F; //CLKDIVbits.PLLPOST = 1;
    CLKDIV |= 0x00C0;

    AD1PCFGH = 0xFFFF; //
    AD1PCFGL = 0xFFFF; // all ports digital I/O
    AD2PCFGL = 0xFFFF; //
```

```

/* Enable ECAN1 Interrupt */
IEC2bits.C1IE = 1; // enable ECAN1 interrupt
C1INTEbits.TBIE = 1; // enable ECAN1 tx interrupt
C1INTEbits.RBIE = 1; // enable ECAN1 rx interrupt

PORTB = 0; // clear PORTB
TRISB = 0; // set PORTB as output,
// for received message data displaying

Can_Init_Flags = 0; //
Can_Send_Flags = 0; // clear flags
Can_Rcv_Flags = 0; //

Can_Send_Flags = _ECAN_TX_PRIORITY_0 & // Form value to be used
                 _ECAN_TX_XTD_FRAME & // with CANSendMessage
                 _ECAN_TX_NO_RTR_FRAME;

Can_Init_Flags = _ECAN_CONFIG_SAMPLE_THRICE & // Form value to be used
                 _ECAN_CONFIG_PHSEG2_PRG_ON & // with CANInitialize
                 _ECAN_CONFIG_XTD_MSG &
                 _ECAN_CONFIG_MATCH_MSG_TYPE &
                 _ECAN_CONFIG_LINE_FILTER_OFF;

ECAN1DmaChannelInit(0, 1, &ECAN1RxTxRAMBuffer); // init dma channel 0 for
// dma to ECAN peripheral transfer
ECAN1DmaChannelInit(2, 0, &ECAN1RxTxRAMBuffer); // init dma channel 2 for
// ECAN peripheral to dma transfer
ECAN1Initialize(1, 3, 3, 3, 1, Can_Init_Flags); // initialize ECAN
ECAN1SetBufferSize(ECAN1RAMBUFFERSIZE); // set number of rx+tx buffers in DMA RAM

ECAN1SelectTxBuffers(0x000F); // select transmit buffers
// 0x000F = buffers 0:3 are transmit buffers
ECAN1SetOperationMode(_ECAN_MODE_CONFIG,0xFF); // set CONFIGURATION mode

ECAN1SetMask(_ECAN_MASK_0, -1, _ECAN_CONFIG_MATCH_MSG_TYPE & _ECAN_CONFIG_XTD_MSG);
// set all mask1 bits to ones
ECAN1SetMask(_ECAN_MASK_1, -1, _ECAN_CONFIG_MATCH_MSG_TYPE & _ECAN_CONFIG_XTD_MSG);
// set all mask2 bits to ones
ECAN1SetMask(_ECAN_MASK_2, -1, _ECAN_CONFIG_MATCH_MSG_TYPE & _ECAN_CONFIG_XTD_MSG);
// set all mask3 bits to ones
ECAN1SetFilter(_ECAN_FILTER_10, 12111, _ECAN_MASK_2, _ECAN_RX_BUFFER_7, _ECAN_CONFIG_
XTD_MSG); // set id of filter10 to 12111,
// assign mask2 to filter10
// assign buffer7 to filter10

ECAN1SetOperationMode(_ECAN_MODE_NORMAL,0xFF); // set NORMAL mode

Tx_ID = 3; // set tx ID

while (1) {
    Msg_Rcvd = ECAN1Read(&Rx_ID , RxTx_Data , &Rx_Data_Len, &Can_Rcv_Flags); // receive
message
    if ((Rx_ID == 12111u) && Msg_Rcvd) { // if message received check id
        PORTB = RxTx_Data[0]; // id correct, output data at PORTB
        RxTx_Data[0]++; // increment received data
        ECAN1Write(Tx_ID, RxTx_Data, 1, Can_Send_Flags); // send incremented data back
    }
}
}

```

HW Connection

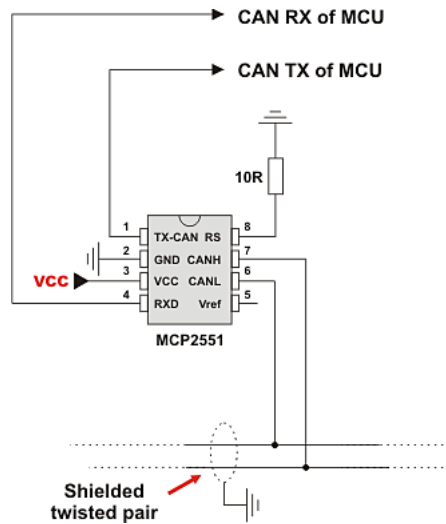

Example of interfacing ECAN transceiver with MCU and bus

EEPROM Library

EEPROM data memory is available with a number of dsPIC30 family and some PIC24 family MCU's. The mikroC PRO for dsPIC30/33 and PIC24 includes a library for comfortable work with MCU's internal EEPROM.

Important : Only PIC24F08KA102 and PIC24F16KA102 of PIC24 family of MCUs have EEPROM memory.

Library Routines

- EEPROM_Erase
- EEPROM_Erase_Block
- EEPROM_Read
- EEPROM_Write
- EEPROM_Write_Block

EEPROM_Erase

Prototype	<code>void EEPROM_Erase(unsigned long address);</code>
Description	Erases a single (16-bit) location from EEPROM memory.
Parameters	- <code>address</code> : address of the EEPROM memory location to be erased.
Returns	Nothing.
Requires	Nothing.
Example	<pre>unsigned long eeAddr = 0x7FFC80; ... EEPROM_Erase(eeAddr);</pre>
Notes	CPU is not halted for the Data Erase cycle. The user can poll WR bit, use NVMIF or Timer IRQ to detect the end of erase sequence.

EEPROM_Erase_Block

Prototype	<code>void EEPROM_Erase_Block(unsigned long address);</code>
Description	Erases one EEPROM row from EEPROM memory; For dsPIC30 family it is 16 words long, for 24F04KA201 and 24F16KA102 family it is 8 words long.
Parameters	- <code>address</code> : starting address of the EEPROM memory block to be erased.
Returns	Nothing.
Requires	Nothing.
Example	<pre>unsigned long eeAddr = 0x7FFC20; ... EEPROM_Erase_Block(eeAddr);</pre>
Notes	CPU is not halted for the Data Erase cycle. The user can poll WR bit, use NVMIF or Timer IRQ to detect the end of erase sequence.

EEPROM_Read

Prototype	<code>unsigned int EEPROM_Read(unsigned long address);</code>
Description	Reads data from specified address.
Parameters	- <code>address</code> : address of the EEPROM memory location to be read.
Returns	Word from the specified address.
Requires	It is the user's responsibility to obtain proper address parity (in this case, even).
Example	<pre>unsigned long eeAddr = 0x7FFC20; unsigned int temp; ... temp = EEPROM_Read(eeAddr);</pre>
Notes	None.

EEPROM_Write

Prototype	<code>void EEPROM_Write(unsigned long address, unsigned int data_);</code>
Description	Writes data to specified address.
Parameters	- <code>address</code> : address of the EEPROM memory location to be written. - <code>data</code> : data to be written.
Returns	Nothing.
Requires	Nothing.
Example	<pre>unsigned int eeWrite = 0xAAAA; unsigned long wrAddr = 0x7FFC30; ... EEPROM_Write(wrAddr, eeWrite);</pre>
Notes	Specified memory location will be erased before writing starts.

EEPROM_Write_Block

Prototype	<code>void EEPROM_Write_Block(unsigned long address, unsigned int *data);</code>
Description	Writes one EEPROM row (16 words block) of data.
Parameters	- <code>address</code> : starting address of the EEPROM memory block to be written. - <code>data</code> : data block to be written.
Returns	Nothing.
Requires	It is the user's responsibility to maintain proper address alignment. In this case, address has to be a multiply of 32, which is the size (in bytes) of one row of MCU's EEPROM memory.
Example	<pre>unsigned int eeWrite = 0xAAAA; unsigned long wrAddr = 0x7FFC30; ... EEPROM_Write(wrAddr, eeWrite);</pre>
Notes	Specified memory block will be erased before writing starts. This routine is not applicable to the 24F04KA201 and 24F16KA102 family of MCUs, due to the architecture specifics.

Library Example

This project demonstrates usage of EEPROM library functions for dsPIC30F4013. Each EEPROM (16-bit) location can be written to individually, or in 16-word blocks, which is somewhat faster than the former. If Writing in blocks, EEPROM data start address must be a multiply of 16. Please read Help for more details on the library functions!

Copy Code To Clipboard

```
unsigned int eeData;
unsigned long eeAddr;
unsigned int dArr[16];

void main() {
    unsigned i;
```

```

ADPCFG = 0xFFFF; // Disable analog inputs

TRISB = 0; // PORTB as output
LATB = 0xFFFF;
eeAddr = 0x7FFC00; // Start address of EEPROM
eeData = 0; // Data to be written

while (eeData <= 0x00FF) {
    EEPROM_Write(eeAddr, eeData++); // Write data into EEPROM
    while(WR_bit); // Wait for write to finish,
    LATB = EEPROM_Read(eeAddr); // then, read the just-written
    // data.
    eeAddr += 2; // Next address of EEPROM memory location

    Delay_ms(30);
}

Delay_ms(1000); // Wait 1 second.

eeData = 0xAAAA;
for (i=0; i<16; i++){ // Initializing array of 16 integers with data
    dArr[i] = eeData;
    eeData = ~eeData;
}

EEPROM_Write_Block(0x7FFC20, dArr); // Write entire row of EEPROM data
while(WR_bit) // Wait for write to finish
    ;

eeAddr = 0x7FFC20; // Address of EEPROM where reading should start
for (i=0; i<16; i++){ // Read the data back
    LATB = EEPROM_Read(eeAddr); // and show it on PORTB
    eeAddr += 2; // Next address of EEPROM memory location
    Delay_ms(500);
}
}

```

Epson S1D13700 Graphic Lcd Library

The mikroC PRO for dsPIC30/33 and PIC24 provides a library for working with Glcds based on Epson S1D13700 controller.

The S1D13700 Glcd is capable of displaying both text and graphics on an LCD panel. The S1D13700 Glcd allows layered text and graphics, scrolling of the display in any direction, and partitioning of the display into multiple screens. It includes 32K bytes of embedded SRAM display memory which is used to store text, character codes, and bit-mapped graphics.

The S1D13700 Glcd handles display controller functions including :

- Transferring data from the controlling microprocessor to the buffer memory
- Reading memory data, converting data to display pixels
- Generating timing signals for the LCD panel

The S1D13700 Glcd is designed with an internal character generator which supports 160, 5x7 pixel characters in internal mask ROM (CGROM) and 64, 8x8 pixel characters in character generator RAM (CGRAM). When the CGROM is not used, up to 256, 8x16 pixel characters are supported in CGRAM.

External dependencies of the Epson S1D13700 Graphic Lcd Library

The following variables must be defined in all projects using S1D13700 Graphic Lcd library:	Description :	Example :
<code>extern sfr char S1D13700_DATA;</code>	System data bus.	<code>char S1D13700_DATA at PORTD;</code>
<code>extern sfr sbit S1D13700_WR;</code>	Write signal.	<code>sbit S1D13700_WR at LATC2_bit;</code>
<code>extern sfr sbit S1D13700_RD;</code>	Read signal.	<code>sbit S1D13700_RD at LATC1_bit;</code>
<code>extern sfr sbit S1D13700_A0;</code>	System Address pin.	<code>sbit S1D13700_A0 at LATC0_bit;</code>
<code>extern sfr sbit S1D13700_RES;</code>	Reset signal.	<code>sbit S1D13700_RES at LATC4_bit;</code>
<code>extern sfr sbit S1D13700_CS;</code>	Chip select.	<code>sbit S1D13700_CS at LATC4_bit;</code>
<code>extern sfr sbit S1D13700_DATA_Direction;</code>	Direction of the system data bus pins.	<code>sbit S1D13700_DATA_Direction at TRISD;</code>
<code>extern sfr sbit S1D13700_WR_Direction;</code>	Direction of the Write pin.	<code>sbit S1D13700_WR_Direction at TRISC2_bit;</code>
<code>extern sfr sbit S1D13700_RD_Direction;</code>	Direction of the Read pin.	<code>sbit S1D13700_RD_Direction at TRISC1_bit;</code>
<code>extern sfr sbit S1D13700_A0_Direction;</code>	Direction of the System Address pin.	<code>sbit S1D13700_A0_Direction at TRISC2_bit;</code>
<code>extern sfr sbit S1D13700_RES_Direction;</code>	Direction of the Reset pin.	<code>sbit S1D13700_RES_Direction at TRISC0_bit;</code>
<code>extern sfr sbit S1D13700_CS_Direction;</code>	Direction of the Chip select pin.	<code>sbit S1D13700_CS_Direction at TRISC4_bit;</code>

Library Routines

- S1D13700_Init
- S1D13700_Write_Command
- S1D13700_Write_Parameter
- S1D13700_Read_Parameter
- S1D13700_Fill
- S1D13700_GrFill
- S1D13700_TxtFill
- S1D13700_Display_GrLayer
- S1D13700_Display_TxtLayer
- S1D13700_Set_Cursor
- S1D13700_Display_Cursor
- S1D13700_Write_Char
- S1D13700_Write_Text
- S1D13700_Dot
- S1D13700_Line
- S1D13700_H_Line
- S1D13700_V_Line
- S1D13700_Rectangle
- S1D13700_Box
- S1D13700_Rectangle_Round_Edges
- S1D13700_Rectangle_Round_Edges_Fill
- S1D13700_Circle
- S1D13700_Circle_Fill
- S1D13700_Image
- S1D13700_PartialImage

S1D13700_Init

Prototype	<code>void S1D13700_Init(unsigned int width, unsigned char height);</code>
Returns	Nothing.
Description	<p>Initializes S1D13700 Graphic Lcd controller.</p> <p>Parameters :</p> <ul style="list-style-type: none"> - <code>width</code>: width of the Glcd panel. - <code>height</code>: height of the Glcd panel.
Requires	<p>Global variables :</p> <ul style="list-style-type: none"> - <code>S1D13700_Data_Port</code>: Data Bus Port. - <code>S1D13700_WR</code>: Write signal pin. - <code>S1D13700_RD</code>: Read signal pin. - <code>S1D13700_A0</code>: Command/Data signal pin. - <code>S1D13700_RES</code>: Reset signal pin. - <code>S1D13700_CS</code>: Chip Select signal pin. <ul style="list-style-type: none"> - <code>S1D13700_Data_Port_Direction</code>: Data Bus Port Direction. - <code>S1D13700_WR_Direction</code>: Direction of Write signal pin. - <code>S1D13700_RD_Direction</code>: Direction of Read signal pin. - <code>S1D13700_A0_Direction</code>: Direction of Command/Data signal pin. - <code>S1D13700_RES_Direction</code>: Direction of Reset signal pin. - <code>S1D13700_CS_Direction</code>: Direction of Chip Select signal pin. <p>must be defined before using this function.</p>
Example	<pre>// S1D13700 module connections char S1D13700_Data_Port at PORTD; sbit S1D13700_WR at LATC2_bit; sbit S1D13700_RD at LATC1_bit; sbit S1D13700_A0 at LATC0_bit; sbit S1D13700_RES at LATC4_bit; sbit S1D13700_CS at LATC5_bit; char S1D13700_Data_Port_Direction at TRISD; sbit S1D13700_WR_Direction at TRISC2_bit; sbit S1D13700_RD_Direction at TRISC1_bit; sbit S1D13700_A0_Direction at TRISC0_bit; sbit S1D13700_RES_Direction at TRISC4_bit; sbit S1D13700_CS_Direction at TRISC5_bit; // End of S1D13700 module connections ... // init display for 320 pixel width, 240 pixel height S1D13700_Init(320, 240);</pre>

S1D13700_Write_Command

Prototype	<code>void S1D13700_Write_Command(char command);</code>																																				
Returns	Nothing.																																				
Description	<p>Writes a command to S1D13700 controller.</p> <p>Parameters :</p> <p>- <code>command</code>: command to be issued :</p> <table border="1" data-bbox="254 418 1006 1323"> <thead> <tr> <th>Value</th> <th>Description</th> </tr> </thead> <tbody> <tr> <td><code>S1D13700_SYSTEM_SET</code></td> <td>General system settings.</td> </tr> <tr> <td><code>S1D13700_POWER_SAVE</code></td> <td>Enter into power saving mode.</td> </tr> <tr> <td><code>S1D13700_DISP_ON</code></td> <td>Turn the display on.</td> </tr> <tr> <td><code>S1D13700_DISP_OFF</code></td> <td>Turn the display off.</td> </tr> <tr> <td><code>S1D13700_SCROLL</code></td> <td>Setup text and graphics address regions.</td> </tr> <tr> <td><code>S1D13700_CS_RIGHT</code></td> <td>Cursor moves right after write to display memory.</td> </tr> <tr> <td><code>S1D13700_CS_LEFT</code></td> <td>Cursor moves left after write to display memory.</td> </tr> <tr> <td><code>S1D13700_CS_UP</code></td> <td>Cursor moves up after write to display memory.</td> </tr> <tr> <td><code>S1D13700_CS_DOWN</code></td> <td>Cursor moves down after write to display memory.</td> </tr> <tr> <td><code>S1D13700_OVLAY</code></td> <td>Configure how layers overlay.</td> </tr> <tr> <td><code>S1D13700_CGRAM_ADR</code></td> <td>Configure character generator RAM address.</td> </tr> <tr> <td><code>S1D13700_HDOT_SCR</code></td> <td>Set horizontal scroll rate.</td> </tr> <tr> <td><code>S1D13700_CSRW</code></td> <td>Set the cursor address.</td> </tr> <tr> <td><code>S1D13700_CSRR</code></td> <td>Read the cursor address.</td> </tr> <tr> <td><code>S1D13700_GRAYSCALE</code></td> <td>Selects the gray scale depth, in bits-per-pixel (bpp).</td> </tr> <tr> <td><code>S1D13700_MEMWRITE</code></td> <td>Write to display memory.</td> </tr> <tr> <td><code>S1D13700_MEMREAD</code></td> <td>Read from display memory.</td> </tr> </tbody> </table>	Value	Description	<code>S1D13700_SYSTEM_SET</code>	General system settings.	<code>S1D13700_POWER_SAVE</code>	Enter into power saving mode.	<code>S1D13700_DISP_ON</code>	Turn the display on.	<code>S1D13700_DISP_OFF</code>	Turn the display off.	<code>S1D13700_SCROLL</code>	Setup text and graphics address regions.	<code>S1D13700_CS_RIGHT</code>	Cursor moves right after write to display memory.	<code>S1D13700_CS_LEFT</code>	Cursor moves left after write to display memory.	<code>S1D13700_CS_UP</code>	Cursor moves up after write to display memory.	<code>S1D13700_CS_DOWN</code>	Cursor moves down after write to display memory.	<code>S1D13700_OVLAY</code>	Configure how layers overlay.	<code>S1D13700_CGRAM_ADR</code>	Configure character generator RAM address.	<code>S1D13700_HDOT_SCR</code>	Set horizontal scroll rate.	<code>S1D13700_CSRW</code>	Set the cursor address.	<code>S1D13700_CSRR</code>	Read the cursor address.	<code>S1D13700_GRAYSCALE</code>	Selects the gray scale depth, in bits-per-pixel (bpp).	<code>S1D13700_MEMWRITE</code>	Write to display memory.	<code>S1D13700_MEMREAD</code>	Read from display memory.
Value	Description																																				
<code>S1D13700_SYSTEM_SET</code>	General system settings.																																				
<code>S1D13700_POWER_SAVE</code>	Enter into power saving mode.																																				
<code>S1D13700_DISP_ON</code>	Turn the display on.																																				
<code>S1D13700_DISP_OFF</code>	Turn the display off.																																				
<code>S1D13700_SCROLL</code>	Setup text and graphics address regions.																																				
<code>S1D13700_CS_RIGHT</code>	Cursor moves right after write to display memory.																																				
<code>S1D13700_CS_LEFT</code>	Cursor moves left after write to display memory.																																				
<code>S1D13700_CS_UP</code>	Cursor moves up after write to display memory.																																				
<code>S1D13700_CS_DOWN</code>	Cursor moves down after write to display memory.																																				
<code>S1D13700_OVLAY</code>	Configure how layers overlay.																																				
<code>S1D13700_CGRAM_ADR</code>	Configure character generator RAM address.																																				
<code>S1D13700_HDOT_SCR</code>	Set horizontal scroll rate.																																				
<code>S1D13700_CSRW</code>	Set the cursor address.																																				
<code>S1D13700_CSRR</code>	Read the cursor address.																																				
<code>S1D13700_GRAYSCALE</code>	Selects the gray scale depth, in bits-per-pixel (bpp).																																				
<code>S1D13700_MEMWRITE</code>	Write to display memory.																																				
<code>S1D13700_MEMREAD</code>	Read from display memory.																																				
Requires	Glcd module needs to be initialized. See the S1D13700_Init routine.																																				
Example	<pre>// Turn the display on S1D13700_Write_Command(S1D13700_DISP_ON);</pre>																																				

S1D13700_Write_Parameter

Prototype	<code>void S1D13700_Write_Parameter(char parameter);</code>
Returns	Nothing.
Description	Writes a parameter to S1D13700 controller. Parameters : - <code>parameter</code> : parameter to be written.
Requires	Glcd module needs to be initialized. See the S1D13700_Init routine. Previously, a command must be sent through S1D13700_Write_Command routine.
Example	<pre>S1D13700_Write_Command(S1D13700_CSRW); // set cursor address S1D13700_Write_Parameter(Lo(start)); // send lower byte of cursor address S1D13700_Write_Parameter(Hi(start)); // send higher byte cursor address</pre>

S1D13700_Read_Parameter

Prototype	<code>char S1D13700_Read_Parameter();</code>
Returns	Nothing.
Description	Reads a parameter from GLCD port.
Requires	Glcd module needs to be initialized. See the S1D13700_Init routine.
Example	<pre>parameter = S1D13700_Read_Parameter();</pre>

S1D13700_Fill

Prototype	<code>void S1D13700_Fill(char d, unsigned int start, unsigned int len);</code>
Returns	Nothing.
Description	Fills Glcd memory block with given byte. Parameters : - <code>d</code> : byte to be written. - <code>start</code> : starting address of the memory block. - <code>len</code> : length of the memory block in bytes.
Requires	Glcd module needs to be initialized. See the S1D13700_Init routine.
Example	<pre>// from the starting address of 0x3000, fill the memory block size of 0x7FFF with 0x20 S1D13700_Fill(0x20, 0x3000, 0x7FFF);</pre>

S1D13700_GrFill

Prototype	<code>void S1D13700_GrFill(char d);</code>
Returns	Nothing.
Description	Fill graphic layer with appropriate value (0 to clear). Parameters : - d: value to fill graphic layer with.
Requires	Glcd module needs to be initialized. See the S1D13700_Init routine.
Example	<pre>// clear current graphic panel S1D13700_GrFill(0);</pre>

S1D13700_TxtFill

Prototype	<code>void S1D13700_TxtFill(char d);</code>
Returns	Nothing.
Description	Fill current text panel with appropriate value (0 to clear). Parameters : - d: this value will be used to fill text panel.
Requires	Glcd module needs to be initialized. See the S1D13700_Init routine.
Example	<pre>// clear current text panel S1D13700_TxtFill(0);</pre>

S1D13700_Display_GrLayer

Prototype	<code>void S1D13700_Display_GrLayer(char mode);</code>										
Returns	Nothing.										
Description	Display selected graphic layer. Parameters : - mode: graphic layer mode. Valid values : <table border="1" data-bbox="249 1281 1242 1477"> <thead> <tr> <th>Value</th> <th>Description</th> </tr> </thead> <tbody> <tr> <td><code>S1D13700_LAYER_OFF</code></td> <td>Turn off graphic layer.</td> </tr> <tr> <td><code>S1D13700_LAYER_ON</code></td> <td>Turn on graphic layer.</td> </tr> <tr> <td><code>S1D13700_LAYER_FLASH_2Hz</code></td> <td>Turn on graphic layer and flash it at the rate of 2 Hz.</td> </tr> <tr> <td><code>S1D13700_LAYER_FLASH_16Hz</code></td> <td>Turn on graphic layer and flash it at the rate of 16 Hz.</td> </tr> </tbody> </table>	Value	Description	<code>S1D13700_LAYER_OFF</code>	Turn off graphic layer.	<code>S1D13700_LAYER_ON</code>	Turn on graphic layer.	<code>S1D13700_LAYER_FLASH_2Hz</code>	Turn on graphic layer and flash it at the rate of 2 Hz.	<code>S1D13700_LAYER_FLASH_16Hz</code>	Turn on graphic layer and flash it at the rate of 16 Hz.
Value	Description										
<code>S1D13700_LAYER_OFF</code>	Turn off graphic layer.										
<code>S1D13700_LAYER_ON</code>	Turn on graphic layer.										
<code>S1D13700_LAYER_FLASH_2Hz</code>	Turn on graphic layer and flash it at the rate of 2 Hz.										
<code>S1D13700_LAYER_FLASH_16Hz</code>	Turn on graphic layer and flash it at the rate of 16 Hz.										
Requires	Glcd module needs to be initialized. See the S1D13700_Init routine.										
Example	<pre>// Turn on graphic layer S1D13700_Display_GrLayer(S1D13700_LAYER_ON);</pre>										

S1D13700_Display_TxtLayer

Prototype	<code>void S1D13700_Display_TxtLayer(char mode);</code>										
Returns	Nothing.										
Description	<p>Display selected text layer.</p> <p>Parameters :</p> <p>- <code>mode</code>: text layer mode. Valid values :</p> <table border="1" data-bbox="288 420 1280 616"> <thead> <tr> <th>Value</th> <th>Description</th> </tr> </thead> <tbody> <tr> <td><code>S1D13700_LAYER_OFF</code></td> <td>Turn off graphic layer.</td> </tr> <tr> <td><code>S1D13700_LAYER_ON</code></td> <td>Turn on graphic layer.</td> </tr> <tr> <td><code>S1D13700_LAYER_FLASH_2Hz</code></td> <td>Turn on graphic layer and flash it at the rate of 2 Hz.</td> </tr> <tr> <td><code>S1D13700_LAYER_FLASH_16Hz</code></td> <td>Turn on graphic layer and flash it at the rate of 16 Hz.</td> </tr> </tbody> </table>	Value	Description	<code>S1D13700_LAYER_OFF</code>	Turn off graphic layer.	<code>S1D13700_LAYER_ON</code>	Turn on graphic layer.	<code>S1D13700_LAYER_FLASH_2Hz</code>	Turn on graphic layer and flash it at the rate of 2 Hz.	<code>S1D13700_LAYER_FLASH_16Hz</code>	Turn on graphic layer and flash it at the rate of 16 Hz.
Value	Description										
<code>S1D13700_LAYER_OFF</code>	Turn off graphic layer.										
<code>S1D13700_LAYER_ON</code>	Turn on graphic layer.										
<code>S1D13700_LAYER_FLASH_2Hz</code>	Turn on graphic layer and flash it at the rate of 2 Hz.										
<code>S1D13700_LAYER_FLASH_16Hz</code>	Turn on graphic layer and flash it at the rate of 16 Hz.										
Requires	Glcd module needs to be initialized. See the S1D13700_Init routine.										
Example	<pre>// Display on text layer S1D13700_Display_TxtLayer(S1D13700_LAYER_ON);</pre>										

S1D13700_Set_Cursor

Prototype	<code>void S1D13700_Set_Cursor(char width, char height, char mode);</code>						
Returns	Nothing.						
Description	<p>Sets cursor properties.</p> <p>Parameters :</p> <p>- <code>width</code>: in pixels-1 (must be less than or equal to the horizontal char size).</p> <p>- <code>height</code>: in lines-1 (must be less than or equal to the vertical char size).</p> <p>- <code>mode</code>: cursor mode. Valid values :</p> <table border="1" data-bbox="288 1168 1280 1284"> <thead> <tr> <th>Value</th> <th>Description</th> </tr> </thead> <tbody> <tr> <td><code>S1D13700_CURSOR_UNDERSCORE</code></td> <td>Set cursor shape - underscore.</td> </tr> <tr> <td><code>S1D13700_CURSOR_BLOCK</code></td> <td>Set cursor shape - block.</td> </tr> </tbody> </table>	Value	Description	<code>S1D13700_CURSOR_UNDERSCORE</code>	Set cursor shape - underscore.	<code>S1D13700_CURSOR_BLOCK</code>	Set cursor shape - block.
Value	Description						
<code>S1D13700_CURSOR_UNDERSCORE</code>	Set cursor shape - underscore.						
<code>S1D13700_CURSOR_BLOCK</code>	Set cursor shape - block.						
Requires	Glcd module needs to be initialized. See the S1D13700_Init routine.						
Example	<pre>// set cursor with the following properties : width 5px, height 10px, cursor shape - block S1D13700_Set_Cursor(5, 10, S1D13700_CURSOR_BLOCK);</pre>						

S1D13700_Display_Cursor

Prototype	<code>void S1D13700_Display_Cursor(char mode);</code>										
Returns	Nothing.										
Description	<p>Displays cursor.</p> <p>Parameters :</p> <p>- <code>mode</code>: mode parameter. Valid values:</p> <table border="1"> <thead> <tr> <th>Value</th> <th>Description</th> </tr> </thead> <tbody> <tr> <td><code>S1D13700_CURSOR_OFF</code></td> <td>Turn off graphic layer.</td> </tr> <tr> <td><code>S1D13700_CURSOR_ON</code></td> <td>Turn on graphic layer.</td> </tr> <tr> <td><code>S1D13700_CURSOR_FLASH_2Hz</code></td> <td>Turn on graphic layer and flash it at the rate of 2 Hz.</td> </tr> <tr> <td><code>S1D13700_CURSOR_FLASH_16Hz</code></td> <td>Turn on graphic layer and flash it at the rate of 16 Hz.</td> </tr> </tbody> </table>	Value	Description	<code>S1D13700_CURSOR_OFF</code>	Turn off graphic layer.	<code>S1D13700_CURSOR_ON</code>	Turn on graphic layer.	<code>S1D13700_CURSOR_FLASH_2Hz</code>	Turn on graphic layer and flash it at the rate of 2 Hz.	<code>S1D13700_CURSOR_FLASH_16Hz</code>	Turn on graphic layer and flash it at the rate of 16 Hz.
Value	Description										
<code>S1D13700_CURSOR_OFF</code>	Turn off graphic layer.										
<code>S1D13700_CURSOR_ON</code>	Turn on graphic layer.										
<code>S1D13700_CURSOR_FLASH_2Hz</code>	Turn on graphic layer and flash it at the rate of 2 Hz.										
<code>S1D13700_CURSOR_FLASH_16Hz</code>	Turn on graphic layer and flash it at the rate of 16 Hz.										
Requires	Glcd module needs to be initialized. See the S1D13700_Init routine.										
Example	<pre>// set cursor on S1D13700_Display_Cursor(S1D13700_CURSOR_ON);</pre>										

S1D13700_Write_Char

Prototype	<code>void S1D13700_Write_Char(unsigned char c, unsigned int x, unsigned int y, unsigned char mode);</code>								
Returns	Nothing.								
Description	<p>Writes a char in the current text layer of Glcd at coordinates (<code>x</code>, <code>y</code>).</p> <p>Parameters :</p> <p>- <code>c</code>: char to be written.</p> <p>- <code>x</code>: char position on x-axis (column).</p> <p>- <code>y</code>: char position on y-axis (row).</p> <p>- <code>mode</code>: mode parameter. Valid values :</p> <table border="1"> <thead> <tr> <th>Value</th> <th>Description</th> </tr> </thead> <tbody> <tr> <td><code>S1D13700_OVERLAY_OR</code></td> <td>In the OR-Mode, text and graphics can be displayed and the data is logically "OR-ed". This is the most common way of combining text and graphics, for example labels on buttons.</td> </tr> <tr> <td><code>S1D13700_OVERLAY_XOR</code></td> <td>In this mode, the text and graphics data are combined via the logical "exclusive OR".</td> </tr> <tr> <td><code>S1D13700_OVERLAY_AND</code></td> <td>The text and graphic data shown on display are combined via the logical "AND function".</td> </tr> </tbody> </table>	Value	Description	<code>S1D13700_OVERLAY_OR</code>	In the OR-Mode, text and graphics can be displayed and the data is logically "OR-ed". This is the most common way of combining text and graphics, for example labels on buttons.	<code>S1D13700_OVERLAY_XOR</code>	In this mode, the text and graphics data are combined via the logical "exclusive OR".	<code>S1D13700_OVERLAY_AND</code>	The text and graphic data shown on display are combined via the logical "AND function".
Value	Description								
<code>S1D13700_OVERLAY_OR</code>	In the OR-Mode, text and graphics can be displayed and the data is logically "OR-ed". This is the most common way of combining text and graphics, for example labels on buttons.								
<code>S1D13700_OVERLAY_XOR</code>	In this mode, the text and graphics data are combined via the logical "exclusive OR".								
<code>S1D13700_OVERLAY_AND</code>	The text and graphic data shown on display are combined via the logical "AND function".								
Requires	Glcd module needs to be initialized. See the S1D13700_Init routine.								
Example	<pre>S1D13700_Write_Char('A', 22, 23, S1D13700_OVERLAY_OR);</pre>								

S1D13700_Write_Text

Prototype	<code>void S1D13700_Write_Text(unsigned char *str, unsigned char x, unsigned char y, char mode);</code>								
Returns	Nothing.								
Description	<p>Writes text in the current text panel of Glcd at coordinates (x, y).</p> <p>Parameters :</p> <ul style="list-style-type: none"> - <code>str</code>: text to be written. - <code>x</code>: text position on x-axis (column). - <code>y</code>: text position on y-axis (row). - <code>mode</code>: mode parameter. Valid values : <table border="1" style="margin-left: 20px;"> <thead> <tr> <th>Value</th> <th>Description</th> </tr> </thead> <tbody> <tr> <td><code>S1D13700_OVERLAY_OR</code></td> <td>In the OR-Mode, text and graphics can be displayed and the data is logically "OR-ed". This is the most common way of combining text and graphics, for example labels on buttons.</td> </tr> <tr> <td><code>S1D13700_OVERLAY_XOR</code></td> <td>In this mode, the text and graphics data are combined via the logical "exclusive OR".</td> </tr> <tr> <td><code>S1D13700_OVERLAY_AND</code></td> <td>The text and graphic data shown on display are combined via the logical "AND function".</td> </tr> </tbody> </table>	Value	Description	<code>S1D13700_OVERLAY_OR</code>	In the OR-Mode, text and graphics can be displayed and the data is logically "OR-ed". This is the most common way of combining text and graphics, for example labels on buttons.	<code>S1D13700_OVERLAY_XOR</code>	In this mode, the text and graphics data are combined via the logical "exclusive OR".	<code>S1D13700_OVERLAY_AND</code>	The text and graphic data shown on display are combined via the logical "AND function".
Value	Description								
<code>S1D13700_OVERLAY_OR</code>	In the OR-Mode, text and graphics can be displayed and the data is logically "OR-ed". This is the most common way of combining text and graphics, for example labels on buttons.								
<code>S1D13700_OVERLAY_XOR</code>	In this mode, the text and graphics data are combined via the logical "exclusive OR".								
<code>S1D13700_OVERLAY_AND</code>	The text and graphic data shown on display are combined via the logical "AND function".								
Requires	Glcd module needs to be initialized. See the S1D13700_Init routine.								
Example	<code>S1D13700_Write_Text("EPSON LIBRARY DEMO, WELCOME !", 0, 0, S1D13700_OVERLAY_OR);</code>								

S1D13700_Dot

Prototype	<code>void S1D13700_Dot(unsigned int x, unsigned int y, unsigned short color);</code>						
Returns	Nothing.						
Description	<p>Draws a dot in the current graphic panel of Glcd at coordinates (x, y).</p> <p>Parameters :</p> <ul style="list-style-type: none"> - <code>x</code>: dot position on x-axis. - <code>y</code>: dot position on y-axis. - <code>color</code>: color parameter. Valid values : <table border="1" style="margin-left: 20px;"> <thead> <tr> <th>Value</th> <th>Description</th> </tr> </thead> <tbody> <tr> <td><code>S1D13700_BLACK</code></td> <td>Black color.</td> </tr> <tr> <td><code>S1D13700_WHITE</code></td> <td>White color.</td> </tr> </tbody> </table>	Value	Description	<code>S1D13700_BLACK</code>	Black color.	<code>S1D13700_WHITE</code>	White color.
Value	Description						
<code>S1D13700_BLACK</code>	Black color.						
<code>S1D13700_WHITE</code>	White color.						
Requires	Glcd module needs to be initialized. See the S1D13700_Init routine.						
Example	<code>S1D13700_Dot(50, 50, S1D13700_WHITE);</code>						

S1D13700_Line

Prototype	<code>void S1D13700_Line(unsigned int x0, unsigned int y0, unsigned int x1, unsigned int y1, unsigned char pcolor);</code>						
Returns	Nothing.						
Description	<p>Draws a line from (x0, y0) to (x1, y1).</p> <p>Parameters :</p> <ul style="list-style-type: none"> - <code>x0</code>: x coordinate of the line start. - <code>y0</code>: y coordinate of the line end. - <code>x1</code>: x coordinate of the line start. - <code>y1</code>: y coordinate of the line end. - <code>pcolor</code>: color parameter. Valid values : <table border="1" style="margin-left: 20px;"> <thead> <tr> <th>Value</th> <th>Description</th> </tr> </thead> <tbody> <tr> <td><code>S1D13700_BLACK</code></td> <td>Black color.</td> </tr> <tr> <td><code>S1D13700_WHITE</code></td> <td>White color.</td> </tr> </tbody> </table>	Value	Description	<code>S1D13700_BLACK</code>	Black color.	<code>S1D13700_WHITE</code>	White color.
Value	Description						
<code>S1D13700_BLACK</code>	Black color.						
<code>S1D13700_WHITE</code>	White color.						
Requires	Glcd module needs to be initialized. See the S1D13700_Init routine.						
Example	<code>S1D13700_Line(0, 0, 239, 127, S1D13700_WHITE);</code>						

S1D13700_H_Line

Prototype	<code>void S1D13700_H_Line(unsigned int x_start, unsigned int x_end, unsigned int y_pos, unsigned short color);</code>						
Returns	Nothing.						
Description	<p>Draws a horizontal line.</p> <p>Parameters :</p> <ul style="list-style-type: none"> - <code>x_start</code>: x coordinate of the line start. - <code>x_end</code>: x coordinate of the line end. - <code>y_pos</code>: line position on the y axis. - <code>pcolor</code>: color parameter. Valid values : <table border="1" style="margin-left: 20px;"> <thead> <tr> <th>Value</th> <th>Description</th> </tr> </thead> <tbody> <tr> <td><code>S1D13700_BLACK</code></td> <td>Black color.</td> </tr> <tr> <td><code>S1D13700_WHITE</code></td> <td>White color.</td> </tr> </tbody> </table>	Value	Description	<code>S1D13700_BLACK</code>	Black color.	<code>S1D13700_WHITE</code>	White color.
Value	Description						
<code>S1D13700_BLACK</code>	Black color.						
<code>S1D13700_WHITE</code>	White color.						
Requires	Glcd module needs to be initialized. See the S1D13700_Init routine.						
Example	<code>S1D13700_Line(0, 0, 239, 127, S1D13700_WHITE);</code>						

S1D13700_V_Line

Prototype	<code>void S1D13700_V_Line(unsigned int y_start, unsigned int y_end, unsigned int x_pos, unsigned short color);</code>						
Returns	Nothing.						
Description	<p>Draws a horizontal line.</p> <p>Parameters :</p> <ul style="list-style-type: none"> - <code>y_start</code>: y coordinate of the line start. - <code>y_end</code>: y coordinate of the line end. - <code>x_pos</code>: line position on the x axis. - <code>pcolor</code>: color parameter. Valid values : <table border="1" style="margin-left: 20px;"> <thead> <tr> <th>Value</th> <th>Description</th> </tr> </thead> <tbody> <tr> <td><code>S1D13700_BLACK</code></td> <td>Black color.</td> </tr> <tr> <td><code>S1D13700_WHITE</code></td> <td>White color.</td> </tr> </tbody> </table>	Value	Description	<code>S1D13700_BLACK</code>	Black color.	<code>S1D13700_WHITE</code>	White color.
Value	Description						
<code>S1D13700_BLACK</code>	Black color.						
<code>S1D13700_WHITE</code>	White color.						
Requires	Glcd module needs to be initialized. See the S1D13700_Init routine.						
Example	<code>S1D13700_Line(0, 0, 239, 127, S1D13700_WHITE);</code>						

S1D13700_Rectangle

Prototype	<code>void S1D13700_Rectangle(unsigned int x0, unsigned int y0, unsigned int x1, unsigned int y1, unsigned char pcolor);</code>						
Returns	Nothing.						
Description	<p>Draws a rectangle on Glcd.</p> <p>Parameters :</p> <ul style="list-style-type: none"> - <code>x0</code>: x coordinate of the upper left rectangle corner. - <code>y0</code>: y coordinate of the upper left rectangle corner. - <code>x1</code>: x coordinate of the lower right rectangle corner. - <code>y1</code>: y coordinate of the lower right rectangle corner. - <code>pcolor</code>: color parameter. Valid values : <table border="1" style="margin-left: 20px;"> <thead> <tr> <th>Value</th> <th>Description</th> </tr> </thead> <tbody> <tr> <td><code>S1D13700_BLACK</code></td> <td>Black color.</td> </tr> <tr> <td><code>S1D13700_WHITE</code></td> <td>White color.</td> </tr> </tbody> </table>	Value	Description	<code>S1D13700_BLACK</code>	Black color.	<code>S1D13700_WHITE</code>	White color.
Value	Description						
<code>S1D13700_BLACK</code>	Black color.						
<code>S1D13700_WHITE</code>	White color.						
Requires	Glcd module needs to be initialized. See the S1D13700_Init routine.						
Example	<code>S1D13700_rectangle(20, 20, 219, 107, S1D13700_WHITE);</code>						

S1D13700_Box

Prototype	<code>void S1D13700_Rectangle(unsigned int x0, unsigned int y0, unsigned int x1, unsigned int y1, unsigned char pcolor);</code>						
Returns	Nothing.						
Description	<p>Draws a rectangle on Glcd.</p> <p>Parameters :</p> <ul style="list-style-type: none"> - <code>x0</code>: x coordinate of the upper left rectangle corner. - <code>y0</code>: y coordinate of the upper left rectangle corner. - <code>x1</code>: x coordinate of the lower right rectangle corner. - <code>y1</code>: y coordinate of the lower right rectangle corner. - <code>pcolor</code>: color parameter. Valid values : <table border="1" style="margin-left: 20px;"> <thead> <tr> <th>Value</th> <th>Description</th> </tr> </thead> <tbody> <tr> <td><code>S1D13700_BLACK</code></td> <td>Black color.</td> </tr> <tr> <td><code>S1D13700_WHITE</code></td> <td>White color.</td> </tr> </tbody> </table>	Value	Description	<code>S1D13700_BLACK</code>	Black color.	<code>S1D13700_WHITE</code>	White color.
Value	Description						
<code>S1D13700_BLACK</code>	Black color.						
<code>S1D13700_WHITE</code>	White color.						
Requires	Glcd module needs to be initialized. See the S1D13700_Init routine.						
Example	<code>S1D13700_Box(0, 119, 239, 127, S1D13700_WHITE);</code>						

S1D13700_Rectangle_Round_Edges

Prototype	<code>void S1D13700_Rectangle_Round_Edges(unsigned int x_upper_left, unsigned int y_upper_left, unsigned int x_bottom_right, unsigned int y_bottom_right, unsigned short round_radius, unsigned short color);</code>						
Returns	Nothing.						
Description	<p>Draws a rounded edge rectangle on Glcd.</p> <p>Parameters :</p> <ul style="list-style-type: none"> - <code>x_upper_left</code>: x coordinate of the upper left rectangle corner. - <code>y_upper_left</code>: y coordinate of the upper left rectangle corner. - <code>x_bottom_right</code>: x coordinate of the lower right rectangle corner. - <code>y_bottom_right</code>: y coordinate of the lower right rectangle corner. - <code>round_radius</code>: radius of the rounded edge. - <code>pcolor</code>: color parameter. Valid values : <table border="1" style="margin-left: 20px;"> <thead> <tr> <th>Value</th> <th>Description</th> </tr> </thead> <tbody> <tr> <td><code>S1D13700_BLACK</code></td> <td>Black color.</td> </tr> <tr> <td><code>S1D13700_WHITE</code></td> <td>White color.</td> </tr> </tbody> </table>	Value	Description	<code>S1D13700_BLACK</code>	Black color.	<code>S1D13700_WHITE</code>	White color.
Value	Description						
<code>S1D13700_BLACK</code>	Black color.						
<code>S1D13700_WHITE</code>	White color.						
Requires	Glcd module needs to be initialized. See the S1D13700_Init routine.						
Example	<code>S1D13700_Rectangle_Round_Edges(20, 20, 219, 107, 12, S1D13700_WHITE);</code>						

S1D13700_Rectangle_Round_Edges_Fill

Prototype	<code>void S1D13700_Rectangle_Round_Edges_Fill(unsigned int x0, unsigned int y0, unsigned int x1, unsigned int y1, unsigned short round_radius, unsigned short color);</code>						
Returns	Nothing.						
Description	<p>Draws a filled rounded edge rectangle on Glcd.</p> <p>Parameters :</p> <ul style="list-style-type: none"> - <code>x_upper_left</code>: x coordinate of the upper left rectangle corner. - <code>y_upper_left</code>: y coordinate of the upper left rectangle corner. - <code>x_bottom_right</code>: x coordinate of the lower right rectangle corner. - <code>y_bottom_right</code>: y coordinate of the lower right rectangle corner. - <code>round_radius</code>: radius of the rounded edge. - <code>pcolor</code>: color parameter. Valid values : <table border="1" style="margin-left: 20px;"> <thead> <tr> <th>Value</th> <th>Description</th> </tr> </thead> <tbody> <tr> <td><code>S1D13700_BLACK</code></td> <td>Black color.</td> </tr> <tr> <td><code>S1D13700_WHITE</code></td> <td>White color.</td> </tr> </tbody> </table>	Value	Description	<code>S1D13700_BLACK</code>	Black color.	<code>S1D13700_WHITE</code>	White color.
Value	Description						
<code>S1D13700_BLACK</code>	Black color.						
<code>S1D13700_WHITE</code>	White color.						
Requires	Glcd module needs to be initialized. See the S1D13700_Init routine.						
Example	<code>S1D13700_Rectangle_Round_Edges_Fill(20, 20, 219, 107, 12, S1D13700_WHITE);</code>						

S1D13700_Circle

Prototype	<code>void S1D13700_Circle(unsigned int x_center, unsigned int y_center, unsigned int radius, unsigned short color);</code>						
Returns	Nothing.						
Description	<p>Draws a circle on Glcd.</p> <p>Parameters :</p> <ul style="list-style-type: none"> - <code>x_center</code>: x coordinate of the circle center. - <code>y_center</code>: y coordinate of the circle center. - <code>radius</code>: radius size. - <code>color</code>: color parameter. Valid values : <table border="1" style="margin-left: 20px;"> <thead> <tr> <th>Value</th> <th>Description</th> </tr> </thead> <tbody> <tr> <td><code>S1D13700_BLACK</code></td> <td>Black color.</td> </tr> <tr> <td><code>S1D13700_WHITE</code></td> <td>White color.</td> </tr> </tbody> </table>	Value	Description	<code>S1D13700_BLACK</code>	Black color.	<code>S1D13700_WHITE</code>	White color.
Value	Description						
<code>S1D13700_BLACK</code>	Black color.						
<code>S1D13700_WHITE</code>	White color.						
Requires	Glcd module needs to be initialized. See the S1D13700_Init routine.						
Example	<code>S1D13700_Circle(120, 64, 110, S1D13700_WHITE);</code>						

S1D13700_Circle_Fill

Prototype	<code>void S1D13700_Circle_Fill(unsigned int x_center, unsigned int y_center, unsigned int radius, unsigned short color);</code>						
Returns	Nothing.						
Description	<p>Draws a filled circle on Glcd.</p> <p>Parameters :</p> <ul style="list-style-type: none"> - <code>x_center</code>: x coordinate of the circle center. - <code>y_center</code>: y coordinate of the circle center. - <code>radius</code>: radius size. - <code>color</code>: color parameter. Valid values : <table border="1" style="margin-left: 20px;"> <thead> <tr> <th>Value</th> <th>Description</th> </tr> </thead> <tbody> <tr> <td><code>S1D13700_BLACK</code></td> <td>Black color.</td> </tr> <tr> <td><code>S1D13700_WHITE</code></td> <td>White color.</td> </tr> </tbody> </table>	Value	Description	<code>S1D13700_BLACK</code>	Black color.	<code>S1D13700_WHITE</code>	White color.
Value	Description						
<code>S1D13700_BLACK</code>	Black color.						
<code>S1D13700_WHITE</code>	White color.						
Requires	Glcd module needs to be initialized. See the S1D13700_Init routine.						
Example	<code>S1D13700_Circle_Fill(120, 64, 110, S1D13700_WHITE);</code>						

S1D13700_Image

Prototype	<code>void S1D13700_Image(const code char *pic);</code>
Returns	Nothing.
Description	<p>Displays bitmap on Glcd.</p> <p>Parameters :</p> <ul style="list-style-type: none"> - <code>image</code>: image to be displayed. Bitmap array is located in code memory. <p>Note : Image dimension must match the display dimension.</p>
Requires	Glcd module needs to be initialized. See the S1D13700_Init routine.
Example	<code>S1D13700_Image(image);</code>

S1D13700_PartialImage

Prototype	<code>void S1D13700_PartialImage(unsigned int x_left, unsigned int y_top, unsigned int width, unsigned int height, unsigned int picture_width, unsigned int picture_height, code const unsigned short * image);</code>
Returns	Nothing.
Description	<p>Displays a partial area of the image on a desired location.</p> <p>Parameters :</p> <ul style="list-style-type: none"> - <code>x_left</code>: x coordinate of the desired location (upper left coordinate). - <code>y_top</code>: y coordinate of the desired location (upper left coordinate). - <code>width</code>: desired image width. - <code>height</code>: desired image height. - <code>picture_width</code>: width of the original image. - <code>picture_height</code>: height of the original image. - <code>image</code>: image to be displayed. Bitmap array is located in code memory. <p>Note : Image dimension must match the display dimension.</p>
Requires	Glcd module needs to be initialized. See the S1D13700_Init routine.
Example	<pre>// Draws a 10x15 part of the image starting from the upper left corner on the coordinate (10,12). Original image size is 16x32. S1D13700_PartialImage(10, 12, 10, 15, 16, 32, image);</pre>

Flash Memory Library

This library provides routines for accessing microcontroller's (internal) Flash memory.

On the dsPIC30/33 and PIC24, Flash memory is mapped to address space 3:2, which means that every 3 consecutive bytes of Flash have 2 consecutive address locations available. That is why mikroE's library allows data to be written to flash in two ways: "regular" and "compact". In the "regular" mode, which is used for word(16-bit) variables, the 3rd (un-addressable) flash memory byte remains unused. In the "compact" mode, which can be used for 1 byte-sized variables/arrays, all flash bytes are being used.

All dsPIC30/33 and PIC24 MCUs use the RTSP module to perform Read/Erase/Write operations on Flash memory. This, together with the internal structure of the Flash, imposes certain rules to be followed when working with Flash memory:

dsPIC30:

- Erasing can be done only in 32-instructions (64 addresses, 96 bytes) memory blocks. This means that the block start address should be a multiply of 64 (i.e. have 6 lower bits set to zero).
- Data is read and written in 4-instructions (8 addresses, 12 bytes) blocks. This means that the block start address should be a multiply of 8 (i.e. have 3 lower bits set to zero).
- On the dsPIC30s, 2 address locations are assigned on every 3 bytes of (flash) program memory. Due to this specific and non-one-to-one address mapping, the mikroC PRO for dsPIC30/33 and PIC24 offers two sets of Flash handling functions: "regular" and "compact".
Using the "regular" set, the user can write one byte of data to a single address, which means that each byte of written data has its own address, but on every 2 written bytes one byte of Flash memory remains empty.
Using the "compact" set, every byte of Flash memory, including those non-addressable, is filled with data; this method can only be used for data organized in bytes.
The "compact" functions have `_Compact` as name suffix.
- For run-time FLASH read/write, the dsPIC30's RTSP module is being used. It organizes data into rows and panels. Each row contains write latches that can hold 4 instructions (12 bytes). The number of panels varies from one dsPIC30 MCU model to another. Because of that, the flash write sequence has been split into several operations (`_Write_Init()`, `_Write_LoadLatch4()`, `_Write_DoWrite()`), in order to be usable on all dsPICs.

PIC24 and dsPIC33:

- Erasing can be done only in 512-instructions (1024 addresses, 1536 bytes) memory blocks, which means that the block start address should be a multiply of 1024 (i.e. have 10 lower bits set to zero).
- Data is read and written in 64-instructions (128 addresses, 192 bytes) blocks. This means that the block start address should be a multiply of 128 (i.e. have 7 lower bits set to zero).
- On the dsPIC33 and PIC24s, 2 address locations are assigned on every 3 bytes of (flash) program memory. Due to this specific and non-one-to-one address mapping, the mikroC PRO for dsPIC30/33 and PIC24 offers two sets of Flash handling functions: "regular" and "compact".
Using the "regular" set, the user can write one byte of data to a single address, which means that each byte of written data has its own address, but on every 2 written bytes one byte of Flash memory remains empty.
Using the "compact" set, every byte of Flash memory, including those non-addressable, is filled with data; this method can only be used for data organized in bytes.
The "compact" functions have `_Compact` as name suffix.

24F04KA201 and 24F16KA102 Family Specifics :

These MCU's have their Flash memory organized into memory blocks of 32 instructions (96 bytes), unlike other PIC24 devices.

Erasing can be done only in 32-instructions (64 addresses, 96 bytes) memory blocks, which means that the block start address should be a multiply of 64 (i.e. have 6 lower bits set to zero).

Data is read and written in 32-instructions (64 addresses, 96 bytes) blocks. This means that the block start address should be a multiply of 64 (i.e. have 6 lower bits set to zero).

Unlike other PIC24 devices, writing or erasing one block of data (32 instructions), is followed by erasing the memory block of the same size (32 instructions).

Library Routines

dsPIC30 Functions

- FLASH_Erase32

- FLASH_Write_Block
- FLASH_Write_Compact
- FLASH_Write_Init
- FLASH_Write_Loadlatch4
- FLASH_Write_Loadlatch4_Compact
- FLASH_Write_DoWrite

- FLASH_Read4
- FLASH_Read4_Compact

PIC24 and dsPIC33 Functions

- FLASH_Erase
- FLASH_Write
- FLASH_Write_Compact
- FLASH_Read
- FLASH_Read_Compact

dsPIC30 Functions

FLASH_Erase32

Prototype	<code>void FLASH_Erase32(unsigned long address);</code>
Description	Erases one block (32 instructions, 64 addresses, 96 bytes) from the program FLASH memory.
Parameters	- <code>address</code> : starting address of the FLASH memory block
Returns	Nothing.
Requires	Nothing.
Example	<pre>//--- erase the 32-instruction block, starting from address 0x006000 FLASH_Erase32(0x006000);</pre>
Notes	The user should take care about the address alignment (see the explanation at the beginning of this page).

FLASH_Write_Block

Prototype	<code>void FLASH_Write_Block(unsigned long address, unsigned int *data_);</code>
Description	Fills one writeable block of Flash memory (4 instructions, 8 addresses, 12 bytes) in the “regular” mode. Addresses and data are being mapped 1-on-1. This also means that 3rd byte of each program location remains unused.
Parameters	- <code>address</code> : starting address of the FLASH memory block - <code>data_</code> : data to be written
Returns	Nothing.
Requires	The block to be written to must be erased first, either from the user code (through the RTSP), or during the programming of MCU. Please note that block size that is to be erased is different from the one that can be written with this function!
Example	<pre>unsigned long flash_address = 0x006000; unsigned int Buffer[4] = {'A', 'B', 'C', 'D'}; ... FLASH_Write_Block(flash_address, Buffer);</pre>
Notes	The user should take care about the address alignment (see the explanation at the beginning of this page).

FLASH_Write_Compact

Prototype	<code>void FLASH_Write_Compact(unsigned long address, void *data_, unsigned bytes);</code>
Description	Fills a portion of Flash memory using the dsPIC30 RTSP module, in the “compact” manner. In this way, several blocks of RTSP’s latch can be written in one pass. One latch block contains 4 instructions (8 addresses, 12 bytes). Up to 8 latch blocks can be written in one round, resulting in a total of 8*12 = 96 bytes. This method uses all available bytes of the program FLASH memory, including those that are not mapped to address space (every 3rd byte).
Parameters	- <code>address</code> : starting address of the FLASH memory block - <code>data_</code> : data to be written - <code>bytes</code> : number of bytes to be written. The amount of bytes to be written must be a multiply of 12, since this is the size of the RTSP’s write latch(es).
Returns	Nothing.
Requires	The block to be written to must be erased first, either from the user code FLASH_Erase32, or during the programming of MCU. Please note that block size that is to be erased is different from the one that can be written with this function!
Example	<pre>unsigned long flash_address = 0x006000; char Buffer[] = "supercalifragillisticexpialidocious"; ... FLASH_Write_Compact(flash_address, Buffer, 36);</pre>
Notes	The user should take care about the address alignment (see the explanation at the beginning of this page).

FLASH_Write_Init

Prototype	<code>void FLASH_Write_Init(unsigned long address, void *data_);</code>
Description	Initializes RTSP for write-to-FLASH operation.
Parameters	- <code>address</code> : starting address of the FLASH memory block - <code>data_</code> : data to be written
Returns	Nothing.
Requires	The block to be written to must be erased first, either from the user code FLASH_Erase32, or during the programming of MCU. Please note that block size that is to be erased is different from the one that can be written with this function!
Example	<pre>//--- Initializes the Flash to be written, starting from address 0x006100, the data is located at *pv1 void *pv1; ... FLASH_Write_Init(0x006100, pv1);</pre>
Notes	The user should take care about the address alignment (see the explanation at the beginning of this page).

FLASH_Write_Loadlatch4

Prototype	<code>void FLASH_Write_Loadlatch4();</code>
Description	Loads the current RTSP write latch with data (4 instructions, 8 addresses, 12 bytes). The data is filled in the "regular" mode.
Parameters	None.
Returns	Nothing.
Requires	<p>The block to be written to must be erased first, either from the user code FLASH_Erase32, or during the programming of MCU. Please note that block size that is to be erased is different from the one that can be written with this function!</p> <p>This function is used as a part of the Flash write sequence, therefore the FLASH_Write_Init function must be called before this one.</p> <p>This function can be called several times before committing the actual write-to-Flash operation FLASH_Write_DoWrite. This depends on the organization of the RTSP module for the certain dsPIC30. Please consult the Datasheet for particular dsPIC30 on this subject.</p>
Example	<pre>//--- writes data from an array, in "regular" manner unsigned int iArr[16] = {'m', 'i', 'k', 'r', 'o', 'E', 'l', 'e', 'k'}; void * pv1; ... pv1 = iArr; FLASH_Write_Init(0x006100, pv1); FLASH_Write_Loadlatch4(); FLASH_Write_Loadlatch4(); FLASH_Write_DoWrite();</pre>
Notes	None.

FLASH_Write_Loadlatch4_Compact

Prototype	<code>void FLASH_Write_Loadlatch4_Compact();</code>
Description	Loads the current RTSP write latch with data (4 instructions, 8 addresses, 12 bytes). The data is filled in the "compact" mode.
Parameters	None.
Returns	Nothing.
Requires	<p>The block to be written to must be erased first, either from the user code FLASH_Erase32, or during the programming of MCU. Please note that block size that is to be erased is different from the one that can be written with this function!</p> <p>This function is used as a part of the Flash write sequence, therefore the FLASH_Write_Init function must be called before this one.</p> <p>This function can be called several times before committing actual write-to-Flash operation FLASH_Write_DoWrite. This depends on the organization of the RTSP module for the certain dsPIC30. Please consult the Datasheet for particular dsPIC30 on this subject.</p>
Example	<pre>//--- writes data from an array of char, in "compact" manner char cArr[] = "supercalifragillisticexpialidocious"; //35+1 bytes void * pv1; ... pv1 = cArr; FLASH_Write_Init(0x006000, pv1); //init FLASH_Write_Loadlatch4_Compact(); //12 bytes FLASH_Write_Loadlatch4_Compact(); //12 bytes FLASH_Write_Loadlatch4_Compact(); //12 bytes FLASH_Write_DoWrite(); //commit write</pre>
Notes	None.

FLASH_Write_DoWrite

Prototype	<code>void FLASH_Write_DoWrite();</code>
Description	Commits the FLASH write operation.
Parameters	None.
Returns	Nothing.
Requires	<p>The block to be written to must be erased first, either from the user code <code>FLASH_Erase32</code>, or during the programming of MCU. Please note that block size that is to be erased is different from the one that can be written with this function!</p> <p>This function is used as a part of the Flash write sequence, therefore <code>FLASH_Write_Init</code> and certain number of <code>FLASH_Write_Loadlatch4</code> or <code>FLASH_Write_Loadlatch4_Compact</code> function calls must be made before this one.</p> <p>This function is to be called once, at the end of the FLASH write sequence.</p>
Example	<pre>//--- writes data from an array, in "regular" manner unsigned int iArr[16] = {'m', 'i', 'k', 'r', 'o', 'E', 'l', 'e', 'k'}; void * pv1; ... pv1 = iArr; FLASH_Write_Init(0x006100, pv1); FLASH_Write_Loadlatch4(); FLASH_Write_Loadlatch4(); FLASH_Write_DoWrite();</pre>
Notes	None.

FLASH_Read4

Prototype	<code>unsigned int* FLASH_Read4(unsigned long address, unsigned int *write_to);</code>
Description	Reads one latch row (4 instructions, 8 addresses) in the "regular" mode.
Parameters	<ul style="list-style-type: none"> - <code>address</code>: starting address of the FLASH memory block to be read - <code>write_to</code>: starting address of RAM buffer for storing read data
Returns	Starting address of RAM buffer for storing read data.
Requires	Nothing.
Example	<pre>//--- reads 8 bytes (4 words) from location 0x006000 and stores it to *pv1; unsigned int *pv1; ... FLASH_Read4(0x006000, pv1);</pre>
Notes	The user should take care of the address alignment (see the explanation at the beginning of this page).

FLASH_Read4_Compact

Prototype	<code>void* FLASH_Read4_Compact(unsigned long address, void *write_to);</code>
Description	Reads one latch row (4 instructions, 8 addresses) in the “compact” mode.
Parameters	- <code>address</code> : starting address of the FLASH memory block to be read - <code>write_to</code> : starting address of RAM buffer for storing read data
Returns	Starting address of RAM buffer for storing read data.
Requires	Nothing.
Example	<pre>//--- reads 12 bytes (4 words) from location 0x006000 and stores it to *pv1; unsigned int *pv1; ... FLASH_Read4_Compact(0x006000, pv1);</pre>
Notes	The user should take care of the address alignment (see the explanation at the beginning of this page).

PIC24 and dsPIC33 Functions

FLASH_Erase

Prototype	<code>void FLASH_Erase(unsigned long address);</code>
Description	Erases one block (512 instructions, 1024 addresses, 1536 bytes) from the program FLASH memory.
Parameters	- <code>address</code> : starting address of the FLASH memory block
Returns	Nothing.
Requires	Nothing.
Example	<pre>//--- erase the flash memory block, starting from address 0x006400 unsigned long flash_address = 0x006400; ... FLASH_Erase(flash_address);</pre>
Notes	The user should take care about the address alignment (see the explanation at the beginning of this page).

FLASH_Write

Prototype	<code>void FLASH_Write(unsigned long address, unsigned int *data_);</code>
Description	Fills one writable block of Flash memory (64 instructions, 128 addresses, 192 bytes) in the “regular” mode. Addresses and data are being mapped 1-on-1. This also means that 3rd byte of each program location remains unused.
Parameters	- <code>address</code> : starting address of the FLASH memory block - <code>data_</code> : data to be written
Returns	Nothing.
Requires	The block to be written to must be erased first, either from the user code (through the RTSP), or during the programming of MCU. Please note that block size that is to be erased is different from the one that can be written with this function!
Example	<pre>unsigned int iArr[64] = {'m', 'i', 'k', 'r', 'o', 'E', 'l', 'e', 'k', 't', 'r', 'o', 'n', 'i', 'k', 'a'}; void * pv1; ... pv1 = iArr; FLASH_Write(0x006500, pv1);</pre>
Notes	The user should take care about the address alignment (see the explanation at the beginning of this page).

FLASH_Write_Compact

Prototype	<code>void FLASH_Write_Compact(unsigned long address, char *data_);</code>
Description	Fills a portion of Flash memory (64 instructions, 128 addresses, 192 bytes) using the dsPIC33 and PIC24s RTSP (Run Time Self Programming) module, in the “compact” manner. This method uses all available bytes of the program FLASH memory, including those that are not mapped to address space (every 3rd byte).
Parameters	- <code>address</code> : starting address of the FLASH memory block - <code>data_</code> : data to be written
Returns	Nothing.
Requires	The block to be written to must be erased first, either from the user code (FLASH_Erase), or during the programming of MCU. Please note that block size that is to be erased is different from the one that can be written with this function!
Example	<pre>char cArr[] = "supercalifragillisticexpialidociousABCDEFGHJKLMNOPRSTUVWXYZ1234"; void * pv1; ... pv1 = cArr; FLASH_Write_Compact(0x006400, pv1);</pre>
Notes	The user should take care of the address alignment (see the explanation at the beginning of this page).

FLASH_Read

Prototype	<code>unsigned int* FLASH_Read(unsigned long address, unsigned int *write_to, unsigned NoWords);</code>
Description	Reads required number of words from the flash memory in the “regular” mode.
Parameters	- <code>address</code> : starting address of the FLASH memory block to be read - <code>write_to</code> : starting address of RAM buffer for storing read data - <code>NoWords</code> : number of words to be read
Returns	Address of RAM buffer for storing read data.
Requires	
Example	<pre>unsigned Buffer[64]; unsigned long start_address = 0x6500; ... FLASH_Read(start_address, Buffer, 10);</pre>
Notes	The user should take care of the address alignment (see the explanation at the beginning of this page).

FLASH_Read_Compact

Prototype	<code>void *FLASH_Read_Compact(unsigned long address, void *write_to, unsigned NoBytes);</code>
Description	Reads required number of bytes from the flash memory in the “compact” mode.
Parameters	- <code>address</code> : starting address of the FLASH memory block to be read - <code>write_to</code> : starting address of RAM buffer for storing read data - <code>NoBytes</code> : number of bytes to be read
Returns	Address of RAM buffer for storing read data.
Requires	
Example	<pre>char Buffer[64]; unsigned long start_address = 0x6500; ... FLASH_Read_Compact(start_address, Buffer, 10);</pre>
Notes	The user should take care of the address alignment (see the explanation at the beginning of this page).

Library Example

In this example written for dsPIC30F4013, various read/write techniques to/from the on-chip FLASH memory are shown. Flash memory is mapped to address space 3:2, meaning every 3 consecutive bytes of Flash have 2 consecutive address locations available.

That is why mikroE's library allows data to be written to Flash in two ways: 'regular' and 'compact'. In 'regular' mode, which is used for variables that are size of 2 bytes and more, the 3rd (un-addressable) byte remains unused.

In 'compact' mode, which can be used for 1 byte-sized variables/arrays, all bytes of flash are being used.

Copy Code To Clipboard

```

unsigned int iArr[8] = {'m', 'i', 'k', 'r', 'o', 'E', 'l', 'e'};
char cArr[] = "mikroElektronika Flash example";
char cArr2[40];

void * pv1;
unsigned bb;

void main() {
    unsigned i;

    pv1 = cArr;

/*
   This is what FLASH_Write_Compact() does 'beneath the hood'
   */
    FLASH_Write_Init(0x006000, pv1);
    FLASH_Write_Loadlatch4_Compact();
    FLASH_Write_Loadlatch4_Compact();
    FLASH_Write_Loadlatch4_Compact();
    FLASH_Write_DoWrite();
*/

    //--- erase the block first
    FLASH_Erase32(0x006000);

    //--- write compact format to flash
    FLASH_Write_Compact(0x006000, pv1, 36);

    //--- read compact format
    pv1 = cArr2;
    FLASH_Read4_Compact(0x006000, pv1);
    pv1 += 12;
    FLASH_Read4_Compact(0x006008, pv1);
    pv1 += 12;
    FLASH_Read4_Compact(0x006010, pv1);
    pv1 += 12;
    *pv1 = 0; //termination

    //--- show what has been written
    i = 0;

```

```
    UART1_Init(9600);
//  UART1_Write_Text("Start");
    UART1_Write(10);
    UART1_Write(13);
    while(cArr2[i]) {
        bb = cArr2[i++];
        UART1_Write(bb);
    }

//--- now for some non-compact flash-write
pv1 = iArr;
//--- erase the block first
FLASH_Erase32(0x006100);
FLASH_Write_Init(0x006100, pv1);
FLASH_Write_Loadlatch4();
FLASH_Write_Loadlatch4();
FLASH_Write_DoWrite();
}
```

Graphic Lcd Library

The mikroC PRO for dsPIC30/33 and PIC24 provides a library for operating Graphic Lcd 128x64 (with commonly used Samsung KS108/KS107 controller).

For creating a custom set of Glcd images use Glcd Bitmap Editor Tool.

Library Dependency Tree



External dependencies of Graphic Lcd Library

The following variables must be defined in all projects using Graphic Lcd Library:	Description :	Example :
<code>extern sfr sbit GLCD_D0;</code>	Data 0 line.	<code>sbit GLCD_D0 at LATB0_bit;</code>
<code>extern sfr sbit GLCD_D1;</code>	Data 1 line.	<code>sbit GLCD_D1 at LATB1_bit;</code>
<code>extern sfr sbit GLCD_D2;</code>	Data 2 line.	<code>sbit GLCD_D2 at LATF2_bit;</code>
<code>extern sfr sbit GLCD_D3;</code>	Data 3 line.	<code>sbit GLCD_D3 at LATF3_bit;</code>
<code>extern sfr sbit GLCD_D4;</code>	Data 4 line.	<code>sbit GLCD_D4 at LATD0_bit;</code>
<code>extern sfr sbit GLCD_D5;</code>	Data 5 line.	<code>sbit GLCD_D5 at LATD1_bit;</code>
<code>extern sfr sbit GLCD_D6;</code>	Data 6 line.	<code>sbit GLCD_D6 at LATD2_bit;</code>
<code>extern sfr sbit GLCD_D7;</code>	Data 7 line.	<code>sbit GLCD_D7 at LATD3_bit;</code>
<code>extern sfr sbit GLCD_CS1;</code>	Chip Select 1 line.	<code>sbit GLCD_CS1 at LATB4_bit;</code>
<code>extern sfr sbit GLCD_CS2;</code>	Chip Select 2 line.	<code>sbit GLCD_CS2 at LATB5_bit;</code>
<code>extern sfr sbit GLCD_RS;</code>	Register select line.	<code>sbit GLCD_RS at LATF0_bit;</code>
<code>extern sfr sbit GLCD_RW;</code>	Read/Write line.	<code>sbit GLCD_RW at LATF1_bit;</code>
<code>extern sfr sbit GLCD_EN;</code>	Enable line.	<code>sbit GLCD_RST at LATF5_bit;</code>
<code>extern sfr sbit GLCD_RST;</code>	Reset line.	<code>sbit GLCD_RST at LATF5_bit;</code>
<code>extern sfr sbit GLCD_D0_Direction;</code>	Direction of the Data 0 pin.	<code>sbit GLCD_D0_Direction at TRISB0_bit;</code>
<code>extern sfr sbit GLCD_D1_Direction;</code>	Direction of the Data 1 pin.	<code>sbit GLCD_D2_Direction at TRISB2_bit;</code>
<code>extern sfr sbit GLCD_D3_Direction;</code>	Direction of the Data 3 pin.	<code>sbit GLCD_D3_Direction at TRISB3_bit;</code>
<code>extern sfr sbit GLCD_D4_Direction;</code>	Direction of the Data 4 pin.	<code>sbit GLCD_D4_Direction at TRISD0_bit;</code>
<code>extern sfr sbit GLCD_D5_Direction;</code>	Direction of the Data 5 pin.	<code>sbit GLCD_D5_Direction at TRISD1_bit;</code>
<code>extern sfr sbit GLCD_D6_Direction;</code>	Direction of the Data 6 pin.	<code>sbit GLCD_D6_Direction at TRISD2_bit;</code>
<code>extern sfr sbit GLCD_D7_Direction;</code>	Direction of the Data 7 pin.	<code>sbit GLCD_D7_Direction at TRISD3_bit;</code>
<code>extern sfr sbit GLCD_CS1_Direction;</code>	Direction of the Chip Select 1 pin.	<code>sbit GLCD_CS1_Direction at TRISB4_bit;</code>
<code>extern sfr sbit GLCD_CS2_Direction;</code>	Direction of the Chip Select 2 pin.	<code>sbit GLCD_CS2_Direction at TRISB5_bit;</code>
<code>extern sfr sbit GLCD_RS_Direction;</code>	Direction of the Register select pin.	<code>sbit GLCD_RS_Direction at TRISF0_bit;</code>
<code>extern sfr sbit GLCD_RW_Direction;</code>	Direction of the Read/Write pin.	<code>sbit GLCD_RW_Direction at TRISF1_bit;</code>
<code>extern sfr sbit GLCD_EN_Direction;</code>	Direction of the Enable pin.	<code>sbit GLCD_EN_Direction at TRISF4_bit;</code>
<code>extern sfr sbit GLCD_RST_Direction;</code>	Direction of the Reset pin.	<code>sbit GLCD_RST_Direction at TRISF5_bit;</code>

Library Routines

Basic routines:

- Glcd_Init
- Glcd_Set_Side
- Glcd_Set_X
- Glcd_Set_Page
- Glcd_Read_Data
- Glcd_Write_Data

Advanced routines:

- Glcd_Fill
- Glcd_Dot
- Glcd_Line
- Glcd_V_Line
- Glcd_H_Line
- Glcd_Rectangle
- Glcd_Rectangle_Round_Edges
- Glcd_Rectangle_Round_Edges_Fill
- Glcd_Box
- Glcd_Circle
- Glcd_Circle_Fill
- Glcd_Set_Font
- Glcd_Write_Char
- Glcd_Write_Text
- Glcd_Image
- Glcd_PartialImage

Glcd_Init

Prototype	<code>void Glcd_Init();</code>
Description	Initializes the Glcd module. Each of the control lines are both port and pin configurable, while data lines must be on a single port (pins <0:7>).
Parameters	None.
Returns	Nothing.
Requires	Global variables : <ul style="list-style-type: none">- <code>GLCD_D0</code> : Data pin 0- <code>GLCD_D1</code> : Data pin 1- <code>GLCD_D2</code> : Data pin 2- <code>GLCD_D3</code> : Data pin 3- <code>GLCD_D4</code> : Data pin 4- <code>GLCD_D5</code> : Data pin 5- <code>GLCD_D6</code> : Data pin 6- <code>GLCD_D7</code> : Data pin 7- <code>GLCD_CS1</code> : Chip select 1 signal pin- <code>GLCD_CS2</code> : Chip select 2 signal pin- <code>GLCD_RS</code> : Register select signal pin- <code>GLCD_RW</code> : Read/Write Signal pin

Requires	<ul style="list-style-type: none"> - GLCD_EN : Enable signal pin - GLCD_RST : Reset signal pin - GLCD_D0_Direction : Direction of the Data pin 0 - GLCD_D1_Direction : Direction of the Data pin 1 - GLCD_D2_Direction : Direction of the Data pin 2 - GLCD_D3_Direction : Direction of the Data pin 3 - GLCD_D4_Direction : Direction of the Data pin 4 - GLCD_D5_Direction : Direction of the Data pin 5 - GLCD_D6_Direction : Direction of the Data pin 6 - GLCD_D7_Direction : Direction of the Data pin 7 - GLCD_CS1_Direction : Direction of the Chip select 1 pin - GLCD_CS2_Direction : Direction of the Chip select 2 pin - GLCD_RS_Direction : Direction of the Register select signal pin - GLCD_RW_Direction : Direction of the Read/Write signal pin - GLCD_EN_Direction : Direction of the Enable signal pin - GLCD_RST_Direction : Direction of the Reset signal pin <p>must be defined before using this function.</p>
Example	<pre> // Glcd pinout settings sbit GLCD_D0 at RB0_bit; sbit GLCD_D1 at RB1_bit; sbit GLCD_D2 at RB2_bit; sbit GLCD_D3 at RB3_bit; sbit GLCD_D4 at RD0_bit; sbit GLCD_D5 at RD1_bit; sbit GLCD_D6 at RD2_bit; sbit GLCD_D7 at RD3_bit; sbit GLCD_CS1 at RB0_bit; sbit GLCD_CS2 at RB1_bit; sbit GLCD_RS at RB2_bit; sbit GLCD_RW at RB3_bit; sbit GLCD_EN at RB4_bit; sbit GLCD_RST at RB5_bit; sbit GLCD_D0_Direction at TRISB0_bit; sbit GLCD_D1_Direction at TRISB1_bit; sbit GLCD_D2_Direction at TRISB2_bit; sbit GLCD_D3_Direction at TRISB3_bit; sbit GLCD_D4_Direction at TRISD0_bit; sbit GLCD_D5_Direction at TRISD1_bit; sbit GLCD_D6_Direction at TRISD2_bit; sbit GLCD_D7_Direction at TRISD3_bit; sbit GLCD_CS1_Direction at TRISB0_bit; sbit GLCD_CS2_Direction at TRISB1_bit; sbit GLCD_RS_Direction at TRISB2_bit; sbit GLCD_RW_Direction at TRISB3_bit; sbit GLCD_EN_Direction at TRISB4_bit; sbit GLCD_RST_Direction at TRISB5_bit; ... Glcd_Init(); </pre>
Notes	None.

Glcd_Set_Side

Prototype	<code>void Glcd_Set_Side(unsigned short x_pos);</code>
Description	Selects Glcd side. Refer to the Glcd datasheet for detailed explanation.
Parameters	- <code>x_pos</code> : Specifies position on x-axis of the Glcd. Valid values: 0..127. Values from 0 to 63 specify the left side, values from 64 to 127 specify the right side of the Glcd.
Returns	Nothing.
Requires	Glcd needs to be initialized, see <code>Glcd_Init</code> routine.
Example	The following two lines are equivalent, and both of them select the left side of Glcd: <pre>Glcd_Select_Side(0); Glcd_Select_Side(10);</pre>
Notes	For side, x axis and page layout explanation see schematic at the bottom of this page.

Glcd_Set_X

Prototype	<code>void Glcd_Set_X(unsigned short x_pos);</code>
Description	Sets x-axis position to <code>x_pos</code> dots from the left border of Glcd within the selected side.
Parameters	- <code>x_pos</code> : position on x-axis. Valid values: 0..63
Returns	Nothing.
Requires	Glcd needs to be initialized, see <code>Glcd_Init</code> routine.
Example	<pre>Glcd_Set_X(25);</pre>
Notes	For side, x axis and page layout explanation see schematic at the bottom of this page.

Glcd_Set_Page

Prototype	<code>void Glcd_Set_Page(unsigned short page);</code>
Description	Selects page of the Glcd.
Parameters	- <code>page</code> : page number. Valid values: 0..7
Returns	Nothing.
Requires	Glcd needs to be initialized, see <code>Glcd_Init</code> routine.
Example	<pre>Glcd_Set_Page(5);</pre>
Notes	For side, x axis and page layout explanation see schematic at the bottom of this page.

Glcd_Read_Data

Prototype	<code>unsigned short Glcd_Read_Data();</code>
Description	Reads data from from the current location of Glcd memory and moves to the next location.
Parameters	None.
Returns	One byte from Glcd memory, formatted as a word (16-bit).
Requires	Glcd needs to be initialized, see Glcd_Init routine. Glcd side, x-axis position and page should be set first. See functions Glcd_Set_Side, Glcd_Set_X, and Glcd_Set_Page.
Example	<pre>unsigned int data_; ... Glcd_Read_Data(); data_ = Glcd_Read_Data();</pre>
Notes	This routine needs to be called twice; After the first call, data is placed in the buffer register. After the second call, data is passed from the buffer register to data lines.

Glcd_Write_Data

Prototype	<code>void Glcd_Write_Data(unsigned short data_);</code>
Returns	Nothing.
Description	Writes one byte to the current location in Glcd memory and moves to the next location. Parameters : - <code>data_</code> : data to be written
Requires	Glcd needs to be initialized, see Glcd_Init routine. Glcd side, x-axis position and page should be set first. See functions Glcd_Set_Side, Glcd_Set_X, and Glcd_Set_Page.
Example	<pre>unsigned short data_; ... Glcd_Write_Data(data_);</pre>

Glcd_Fill

Prototype	<code>void Glcd_Fill(unsigned short pattern);</code>
Description	Fills Glcd memory with the byte pattern. To clear the Glcd screen, use <code>Glcd_Fill(0)</code> . To fill the screen completely, use <code>Glcd_Fill(0xFF)</code> .
Parameters	- <code>pattern</code> : byte to fill Glcd memory with.
Returns	Nothing.
Requires	Glcd needs to be initialized, see <code>Glcd_Init</code> routine.
Example	<pre>// Clear screen Glcd_Fill(0);</pre>
Notes	None.

Glcd_Dot

Prototype	<code>void Glcd_Dot(unsigned short x_pos, unsigned short y_pos, unsigned short color);</code>
Description	Draws a dot on Glcd at coordinates (<code>x_pos</code> , <code>y_pos</code>).
Parameters	- <code>x_pos</code> : x position. Valid values: 0..127 - <code>y_pos</code> : y position. Valid values: 0..63 - <code>color</code> : color parameter. Valid values: 0..2 The parameter <code>color</code> determines a dot state: 0 clears dot, 1 puts a dot, and 2 inverts dot state.
Returns	Nothing.
Requires	Glcd needs to be initialized, see <code>Glcd_Init</code> routine.
Example	<pre>// Invert the dot in the upper left corner Glcd_Dot(0, 0, 2);</pre>
Notes	For x and y axis layout explanation see schematic at the bottom of this page.

Glcd_Line

Prototype	<code>void Glcd_Line(int x_start, int y_start, int x_end, int y_end, unsigned short color);</code>
Description	Draws a line on Glcd.
Parameters	- <code>x_start</code> : x coordinate of the line start. Valid values: 0..127 - <code>y_start</code> : y coordinate of the line start. Valid values: 0..63 - <code>x_end</code> : x coordinate of the line end. Valid values: 0..127 - <code>y_end</code> : y coordinate of the line end. Valid values: 0..63 - <code>color</code> : color parameter. Valid values: 0..2 The parameter <code>color</code> determines the line color: 0 white, 1 black, and 2 inverts each dot.
Returns	Nothing.
Requires	Glcd needs to be initialized, see <code>Glcd_Init</code> routine.
Example	<pre>// Draw a line between dots (0,0) and (20,30) Glcd_Line(0, 0, 20, 30, 1);</pre>
Notes	None.

Glcd_V_Line

Prototype	<code>void Glcd_V_Line(unsigned short y_start, unsigned short y_end, unsigned short x_pos, unsigned short color);</code>
Description	Draws a vertical line on Glcd.
Parameters	<ul style="list-style-type: none"> - <code>y_start</code>: y coordinate of the line start. Valid values: 0..63 - <code>y_end</code>: y coordinate of the line end. Valid values: 0..63 - <code>x_pos</code>: x coordinate of vertical line. Valid values: 0..127 - <code>color</code>: color parameter. Valid values: 0..2 <p>The parameter <code>color</code> determines the line color: 0 white, 1 black, and 2 inverts each dot.</p>
Returns	Nothing.
Requires	Glcd needs to be initialized, see <code>Glcd_Init</code> routine.
Example	<pre>// Draw a vertical line between dots (10,5) and (10,25) Glcd_V_Line(5, 25, 10, 1);</pre>
Notes	None.

Glcd_H_Line

Prototype	<code>void Glcd_H_Line(unsigned short x_start, unsigned short x_end, unsigned short y_pos, unsigned short color);</code>
Description	Draws a horizontal line on Glcd.
Parameters	<ul style="list-style-type: none"> - <code>x_start</code>: x coordinate of the line start. Valid values: 0..127 - <code>x_end</code>: x coordinate of the line end. Valid values: 0..127 - <code>y_pos</code>: y coordinate of horizontal line. Valid values: 0..63 - <code>color</code>: color parameter. Valid values: 0..2 <p>The parameter <code>color</code> determines the line color: 0 white, 1 black, and 2 inverts each dot.</p>
Returns	Nothing.
Requires	Glcd needs to be initialized, see <code>Glcd_Init</code> routine.
Example	<pre>// Draw a horizontal line between dots (10,20) and (50,20) Glcd_H_Line(10, 50, 20, 1);</pre>
Notes	None.

Glcd_Rectangle

Prototype	<code>void Glcd_Rectangle(unsigned short x_upper_left, unsigned short y_upper_left, unsigned short x_bottom_right, unsigned short y_bottom_right, unsigned short color);</code>
Description	Draws a rectangle on Glcd.
Parameters	<ul style="list-style-type: none"> - <code>x_upper_left</code>: x coordinate of the upper left rectangle corner. Valid values: 0..127 - <code>y_upper_left</code>: y coordinate of the upper left rectangle corner. Valid values: 0..63 - <code>x_bottom_right</code>: x coordinate of the lower right rectangle corner. Valid values: 0..127 - <code>y_bottom_right</code>: y coordinate of the lower right rectangle corner. Valid values: 0..63 - <code>color</code>: color parameter. Valid values: 0..2 <p>The parameter <code>color</code> determines the color of the rectangle border: 0 white, 1 black, and 2 inverts each dot.</p>
Returns	Nothing.
Requires	Glcd needs to be initialized, see <code>Glcd_Init</code> routine.
Example	<pre>// Draw a rectangle between dots (5,5) and (40,40) Glcd_Rectangle(5, 5, 40, 40, 1);</pre>
Notes	None.

Glcd_Rectangle_Round_Edges

Prototype	<code>void Glcd_Rectangle_Round_Edges(unsigned short x_upper_left, unsigned short y_upper_left, unsigned short x_bottom_right, unsigned short y_bottom_right, unsigned short round_radius, unsigned short color);</code>
Description	Draws a rounded edge rectangle on Glcd.
Parameters	<ul style="list-style-type: none"> - <code>x_upper_left</code>: x coordinate of the upper left rectangle corner. Valid values: 0..127 - <code>y_upper_left</code>: y coordinate of the upper left rectangle corner. Valid values: 0..63 - <code>x_bottom_right</code>: x coordinate of the lower right rectangle corner. Valid values: 0..127 - <code>y_bottom_right</code>: y coordinate of the lower right rectangle corner. Valid values: 0..63 - <code>round_radius</code>: radius of the rounded edge. - <code>color</code>: color parameter. Valid values: 0..2 <p>The parameter <code>color</code> determines the color of the rectangle border: 0 white, 1 black, and 2 inverts each dot.</p>
Returns	Nothing.
Requires	Glcd needs to be initialized, see <code>Glcd_Init</code> routine.
Example	<pre>// Draw a rounded edge rectangle between dots (5,5) and (40,40) with the radius of 12 Glcd_Rectangle_Round_Edges(5, 5, 40, 40, 12, 1);</pre>
Notes	None.

Glcd_Rectangle_Round_Edges_Fill

Prototype	<code>void Glcd_Rectangle_Round_Edges_Fill(unsigned short x_upper_left, unsigned short y_upper_left, unsigned short x_bottom_right, unsigned short y_bottom_right, unsigned short round_radius, unsigned short color);</code>
Description	Draws a filled rounded edge rectangle on Glcd with color.
Parameters	<ul style="list-style-type: none"> - <code>x_upper_left</code>: x coordinate of the upper left rectangle corner. Valid values: 0..127 - <code>y_upper_left</code>: y coordinate of the upper left rectangle corner. Valid values: 0..63 - <code>x_bottom_right</code>: x coordinate of the lower right rectangle corner. Valid values: 0..127 - <code>y_bottom_right</code>: y coordinate of the lower right rectangle corner. Valid values: 0..63 - <code>round_radius</code>: radius of the rounded edge - <code>color</code>: color parameter. Valid values: 0..2 <p>The parameter color determines the color of the rectangle border: 0 white, 1 black, and 2 inverts each dot.</p>
Returns	Nothing.
Requires	Glcd needs to be initialized, see Glcd_Init routine.
Example	<pre>// Draws a filled rounded edge rectangle between dots (5,5) and (40,40) with the radius of 12 Glcd_Rectangle_Round_Edges_Fill(5, 5, 40, 40, 12, 1);</pre>
Notes	None.

Glcd_Box

Prototype	<code>void Glcd_Box(unsigned short x_upper_left, unsigned short y_upper_left, unsigned short x_bottom_right, unsigned short y_bottom_right, unsigned short color);</code>
Description	Draws a box on Glcd. Parameters :
Parameters	<ul style="list-style-type: none"> - <code>x_upper_left</code>: x coordinate of the upper left box corner. Valid values: 0..127 - <code>y_upper_left</code>: y coordinate of the upper left box corner. Valid values: 0..63 - <code>x_bottom_right</code>: x coordinate of the lower right box corner. Valid values: 0..127 - <code>y_bottom_right</code>: y coordinate of the lower right box corner. Valid values: 0..63 - <code>color</code>: color parameter. Valid values: 0..2 <p>The parameter color determines the color of the box fill: 0 white, 1 black, and 2 inverts each dot.</p>
Returns	Nothing.
Requires	Glcd needs to be initialized, see Glcd_Init routine.
Example	<pre>// Draw a box between dots (5,15) and (20,40) Glcd_Box(5, 15, 20, 40, 1);</pre>
Notes	None.

Glcd_Circle

Prototype	<code>void Glcd_Circle(int x_center, int y_center, int radius, unsigned short color);</code>
Description	Draws a circle on Glcd.1
Parameters	<ul style="list-style-type: none"> - <code>x_center</code>: x coordinate of the circle center. Valid values: 0..127 - <code>y_center</code>: y coordinate of the circle center. Valid values: 0..63 - <code>radius</code>: radius size - <code>color</code>: color parameter. Valid values: 0..2 <p>The parameter color determines the color of the circle line: 0 white, 1 black, and 2 inverts each dot.</p>
Returns	Nothing.
Requires	Glcd needs to be initialized, see Glcd_Init routine.
Example	<pre>// Draw a circle with center in (50,50) and radius=10 Glcd_Circle(50, 50, 10, 1);</pre>
Notes	None.

Glcd_Circle_Fill

Prototype	<code>void Glcd_Circle_Fill(int x_center, int y_center, int radius, unsigned short color);</code>
Description	Draws a filled circle on Glcd.
Parameters	<ul style="list-style-type: none"> - <code>x_center</code>: x coordinate of the circle center. Valid values: 0..127 - <code>y_center</code>: y coordinate of the circle center. Valid values: 0..63 - <code>radius</code>: radius size - <code>color</code>: color parameter. Valid values: 0..2
Returns	Nothing.
Requires	Glcd needs to be initialized, see Glcd_Init routine.
Example	<pre>// Draws a filled circle with center in (50,50) and radius=10 Glcd_Circle_Fill(50, 50, 10, 1);</pre>
Notes	None.

Glcd_Set_Font

Prototype	<code>void Glcd_Set_Font(const char *activeFont, unsigned short aFontWidth, unsigned short aFontHeight, unsigned int aFontOffs);</code>
Description	Sets font that will be used with Glcd_Write_Char and Glcd_Write_Text routines.
Parameters	<p>- <code>activeFont</code>: font to be set. Needs to be formatted as an array of char</p> <p>- <code>aFontWidth</code>: width of the font characters in dots.</p> <p>- <code>aFontHeight</code>: height of the font characters in dots.</p> <p>- <code>aFontOffs</code>: number that represents difference between the mikroC PRO for dsPIC30/33 and PIC24 character set and regular ASCII set (eg. if 'A' is 65 in ASCII character, and 'A' is 45 in the mikroC PRO for dsPIC30/33 and PIC24 character set, aFontOffs is 20). Demo fonts supplied with the library have an offset of 32, which means that they start with space.</p> <p>The user can use fonts given in the file “__Lib_GLCDFonts” file located in the Uses folder or create his own fonts.</p> <p>List of supported fonts:</p> <ul style="list-style-type: none"> - <code>Font_Glcd_System3x5</code> - <code>Font_Glcd_System5x7</code> - <code>Font_Glcd_5x7</code> - <code>Font_Glcd_Character8x7</code> <p>For the sake of the backward compatibility, these fonts are supported also:</p> <ul style="list-style-type: none"> - <code>System3x5</code> (equivalent to <code>Font_Glcd_System3x5</code>) - <code>FontSystem5x7_v2</code> (equivalent to <code>Font_Glcd_System5x7</code>) - <code>font5x7</code> (equivalent to <code>Font_Glcd_5x7</code>) - <code>Character8x7</code> (equivalent to <code>Font_Glcd_Character8x7</code>)
Returns	Nothing.
Requires	Glcd needs to be initialized, see Glcd_Init routine.
Example	<pre>// Use the custom 5x7 font "myfont" which starts with space (32): Glcd_Set_Font(&myfont, 5, 7, 32);</pre>
Notes	None.

Glcd_Write_Char

Prototype	<code>void Glcd_Write_Char(unsigned short character, unsigned short x_pos, unsigned short page_num, unsigned short color);</code>
Description	Prints character on the Glcd.
Parameters	<ul style="list-style-type: none"> - <code>character</code>: character to be written - <code>x_pos</code>: character starting position on x-axis. Valid values: 0..(127-FontWidth) - <code>page_num</code>: the number of the page on which character will be written. Valid values: 0..7 - <code>color</code>: color parameter. Valid values: 0..2 <p>The parameter <code>color</code> determines the color of the character: 0 white, 1 black, and 2 inverts each dot.</p>
Returns	Nothing.
Requires	Glcd needs to be initialized, see <code>Glcd_Init</code> routine. Use <code>Glcd_Set_Font</code> to specify the font for display; if no font is specified, then default <code>Font_Glcd_System5x7</code> font supplied with the library will be used.
Example	<pre>// Write character 'C' on the position 10 inside the page 2: Glcd_Write_Char('C', 10, 2, 1);</pre>
Notes	For x axis and page layout explanation see schematic at the bottom of this page.

Glcd_Write_Text

Prototype	<code>void Glcd_Write_Text(char *text, unsigned short x_pos, unsigned short page_num, unsigned short color);</code>
Description	Prints text on Glcd.
Parameters	<ul style="list-style-type: none"> - <code>text</code>: text to be written - <code>x_pos</code>: text starting position on x-axis. - <code>page_num</code>: the number of the page on which text will be written. Valid values: 0..7 - <code>color</code>: color parameter. Valid values: 0..2 <p>The parameter <code>color</code> determines the color of the text: 0 white, 1 black, and 2 inverts each dot.</p>
Returns	Nothing.
Requires	Glcd needs to be initialized, see <code>Glcd_Init</code> routine. Use <code>Glcd_Set_Font</code> to specify the font for display; if no font is specified, then default <code>Font_Glcd_System5x7</code> font supplied with the library will be used.
Example	<pre>// Write text "Hello world!" on the position 10 inside the page 2: Glcd_Write_Text("Hello world!", 10, 2, 1);</pre>
Notes	For x axis and page layout explanation see schematic at the bottom of this page.

Glcd_Image

Prototype	<code>void Glcd_Image(code const unsigned short *image);</code>
Description	Displays bitmap on Glcd.
Parameters	- <code>image</code> : image to be displayed. Bitmap array can be located in both code and RAM memory (due to the mikroC PRO for dsPIC30/33 and PIC24 pointer to const and pointer to RAM equivalency).
Returns	Nothing.
Requires	Glcd needs to be initialized, see <code>Glcd_Init</code> routine.
Example	<pre>// Draw image my_image on Glcd Glcd_Image(my_image);</pre>
Notes	Use the mikroC PRO for dsPIC30/33 and PIC24 integrated Glcd Bitmap Editor, Tools > Glcd Bitmap Editor , to convert image to a constant array suitable for displaying on Glcd.

Glcd_PartialImage

Prototype	<code>void Glcd_PartialImage(unsigned int x_left, unsigned int y_top, unsigned int width, unsigned int height, unsigned int picture_width, unsigned int picture_height, code const unsigned short * image);</code>
Description	Displays a partial area of the image on a desired location.
Parameters	- <code>x_left</code> : x coordinate of the desired location (upper left coordinate). - <code>y_top</code> : y coordinate of the desired location (upper left coordinate). - <code>width</code> : desired image width. - <code>height</code> : desired image height. - <code>picture_width</code> : width of the original image. - <code>picture_height</code> : height of the original image. - <code>image</code> : image to be displayed. Bitmap array can be located in both code and RAM memory (due to the mikroC PRO for PIC pointer to const and pointer to RAM equivalency).
Returns	Nothing.
Requires	Glcd needs to be initialized, see <code>Glcd_Init</code> routine.
Example	<pre>// Draws a 10x15 part of the image starting from the upper left corner on the coordinate (10,12). Original image size is 16x32. Glcd_PartialImage(10, 12, 10, 15, 16, 32, image);</pre>
Notes	Use the mikroC PRO for dsPIC30/33 and PIC24 integrated Glcd Bitmap Editor, Tools > Glcd Bitmap Editor , to convert image to a constant array suitable for displaying on Glcd.

Library Example

The following drawing demo tests advanced routines of the Glcd library.

Copy Code To Clipboard

```
//Declarations-----  
const code char truck_bmp[1024];  
//-----end-declarations  
  
// Glcd module connections  
sbit GLCD_D7 at RD3_bit;  
sbit GLCD_D6 at RD2_bit;  
sbit GLCD_D5 at RD1_bit;  
sbit GLCD_D4 at RD0_bit;  
sbit GLCD_D3 at RB3_bit;  
sbit GLCD_D2 at RB2_bit;  
sbit GLCD_D1 at RB1_bit;  
sbit GLCD_D0 at RB0_bit;  
sbit GLCD_D7_Direction at TRISD3_bit;  
sbit GLCD_D6_Direction at TRISD2_bit;  
sbit GLCD_D5_Direction at TRISD1_bit;  
sbit GLCD_D4_Direction at TRISD0_bit;  
sbit GLCD_D3_Direction at TRISB3_bit;  
sbit GLCD_D2_Direction at TRISB2_bit;  
sbit GLCD_D1_Direction at TRISB1_bit;  
sbit GLCD_D0_Direction at TRISB0_bit;  
  
sbit GLCD_CS1 at LATB4_bit;  
sbit GLCD_CS2 at LATB5_bit;  
sbit GLCD_RS at LATA0_bit;  
sbit GLCD_RW at LATA1_bit;  
sbit GLCD_EN at LATA4_bit;  
sbit GLCD_RST at LATA5_bit;  
sbit GLCD_CS1_Direction at TRISB4_bit;  
sbit GLCD_CS2_Direction at TRISB5_bit;  
sbit GLCD_RS_Direction at TRISF0_bit;  
sbit GLCD_RW_Direction at TRISF1_bit;  
sbit GLCD_EN_Direction at TRISF4_bit;  
sbit GLCD_RST_Direction at TRISF5_bit;  
// End Glcd module connections  
  
void delay2S() { // 2 seconds delay function  
    Delay_ms(2000);  
}  
  
void main() {  
    unsigned short ii;  
    char *someText;  
  
    #define COMPLETE_EXAMPLE // Comment this line to make simpler/smaller example  
    ADPCFG = 0xFFFF; // Configure AN pins as digital
```

```

Glcd_Init(); // Initialize GLCD
Glcd_Fill(0x00); // Clear GLCD

while(1) {
#ifdef COMPLETE_EXAMPLE
    Glcd_Image(truck_bmp); // Draw image
    delay2S(); delay2S();
#endif

    Glcd_Fill(0x00); // Clear GLCD

    Glcd_Box(62,40,124,56,1); // Draw box
    Glcd_Rectangle(5,5,84,35,1); // Draw rectangle
    Glcd_Line(0, 0, 127, 63, 1); // Draw line
    delay2S();

for(ii = 5; ii < 60; ii+=5 ){ // Draw horizontal and vertical lines
    Delay_ms(250);
    Glcd_V_Line(2, 54, ii, 1);
    Glcd_H_Line(2, 120, ii, 1);
}

    delay2S();

    Glcd_Fill(0x00); // Clear GLCD
#ifdef COMPLETE_EXAMPLE
    Glcd_Set_Font(Character8x7, 8, 7, 32); // Choose font, see __Lib_GLCDFonts.c
in Uses folder
#endif
    Glcd_Write_Text("mikroE", 1, 7, 2); // Write string

for (ii = 1; ii <= 10; ii++) // Draw circles
    Glcd_Circle(63,32, 3*ii, 1);
    delay2S();

    Glcd_Box(12,20, 70,57, 2); // Draw box
    delay2S();

#ifdef COMPLETE_EXAMPLE
    Glcd_Fill(0xFF); // Fill GLCD

    Glcd_Set_Font(Character8x7, 8, 7, 32); // Change font
    someText = "8x7 Font";
    Glcd_Write_Text(someText, 5, 0, 2); // Write string
    delay2S();

    Glcd_Set_Font(System3x5, 3, 5, 32); // Change font
    someText = "3X5 CAPITALS ONLY";
    Glcd_Write_Text(someText, 60, 2, 2); // Write string
    delay2S();

```

```

Glcd_Set_Font(font5x7, 5, 7, 32);           // Change font
someText = "5x7 Font";
Glcd_Write_Text(someText, 5, 4, 2);       // Write string
delay2S();

Glcd_Set_Font(FontSystem5x7_v2, 5, 7, 32); // Change font
someText = "5x7 Font (v2)";
Glcd_Write_Text(someText, 5, 6, 2);       // Write string
delay2S();
#endif
}
}

```

HW Connection

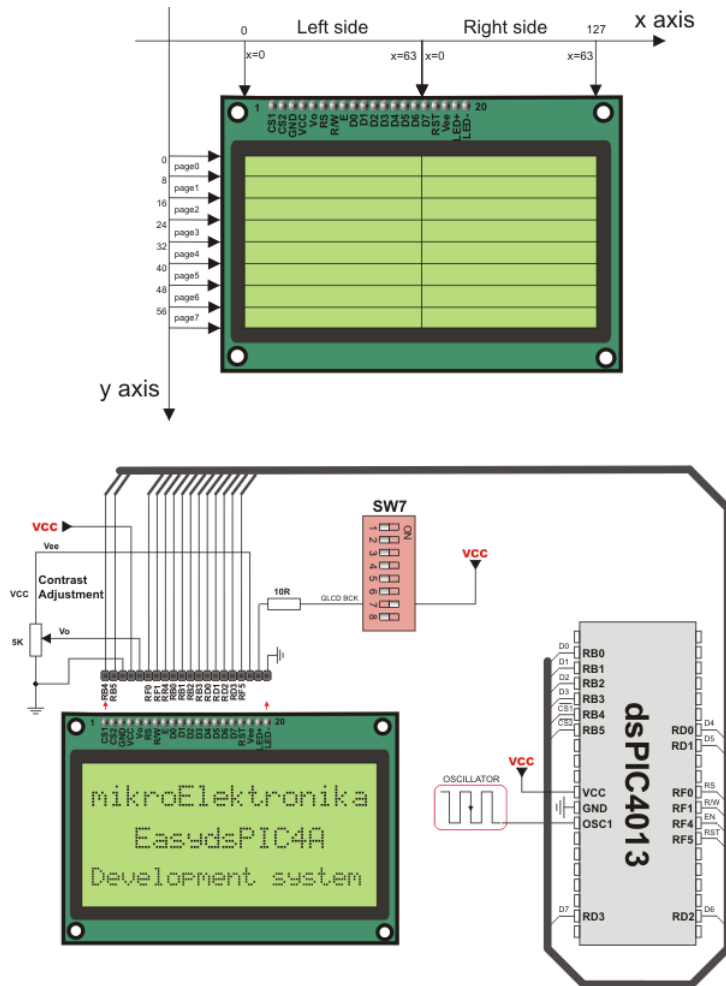

Glcd HW connection

I²C Library

The I²C full master I²C module is available with a number of the dsPIC30/33 and PIC24 MCU models. The mikroC PRO for dsPIC30/33 and PIC24 provides a library which supports the master I²C mode.

Important :

- I²C library routines require you to specify the module you want to use. To select the desired I²C module, simply change the letter **x** in the routine prototype for a number from **1** to **3**.
- Number of I²C modules per MCU differs from chip to chip. Please, read the appropriate datasheet before utilizing this library.

Library Routines

- I2Cx_Init
- I2Cx_Start
- I2Cx_Restart
- I2Cx_Is_Idle
- I2Cx_Read
- I2Cx_Write
- I2Cx_Stop

I2Cx_Init

Prototype	<code>void I2Cx_Init(unsigned long scl);</code>
Description	<p>Configures and initializes the desired I²C module with default settings.</p> <p>This function enables the I²C module by setting the I2CEN bit. The rest of the bits in I²C control register remains unchanged. Default initialization (after reset) of I²C module is:</p> <ul style="list-style-type: none"> - continue operation in IDLE mode - IPMI mode disabled - 7-bit slave address - slew rate control enabled - general call address disabled - software or receive clock stretching disabled
Parameters	- <code>scl</code> : requested serial clock rate.
Returns	Nothing.
Requires	MCU with the I ² C module.
Example	<pre>// Initialize the I2C1 module with clock_rate of 100000 I2C1_Init(100000);</pre>
Notes	<p>Refer to the MCU's datasheet for correct values of the <code>scl</code> in respect with <code>Fosc</code>.</p> <p>I²C library routines require you to specify the module you want to use. To select the desired I²C module, simply change the letter x in the routine prototype for a number from 1 to 3.</p> <p>Number of I²C modules per MCU differs from chip to chip. Please, read the appropriate datasheet before utilizing this library.</p>

I2Cx_Start

Prototype	<code>void I2Cx_Start();</code>
Description	Determines if the I ² C bus is free and issues START signal.
Parameters	None.
Returns	Nothing.
Requires	MCU with at least one I ² C module. Used I ² C module must be initialized before using this function. See I2Cx_Init routine.
Example	<pre>// Issue START signal I2C1_Start();</pre>
Notes	I ² C library routines require you to specify the module you want to use. To select the desired I ² C module, simply change the letter x in the routine prototype for a number from 1 to 3 . Number of I ² C modules per MCU differs from chip to chip. Please, read the appropriate datasheet before utilizing this library.

I2Cx_Restart

Prototype	<code>void I2Cx_Restart();</code>
Description	Issues repeated START signal.
Parameters	None.
Returns	Nothing.
Requires	MCU with at least one I ² C module. Used I ² C module must be initialized before using this function. See I2Cx_Init routine.
Example	<pre>// Issue RESTART signal I2C1_Restart();</pre>
Notes	I ² C library routines require you to specify the module you want to use. To select the desired I ² C module, simply change the letter x in the routine prototype for a number from 1 to 3 . Number of I ² C modules per MCU differs from chip to chip. Please, read the appropriate datasheet before utilizing this library.

I2Cx_Is_Idle

Prototype	<code>unsigned I2Cx_Is_Idle();</code>
Description	Waits for the I ² C bus to become free. This is a blocking function.
Parameters	None.
Returns	- 0 if I ² C bus is free. - 1 if I ² C bus is not free.
Requires	MCU with at least one I ² C module. Used I ² C module must be initialized before using this function. See I2Cx_Init routine.
Example	<pre>unsigned char data_; ... if !(I2C1_Is_Idle) I2C1_Write(data_); ...</pre>
Notes	I ² C library routines require you to specify the module you want to use. To select the desired I ² C module, simply change the letter x in the routine prototype for a number from 1 to 3 . Number of I ² C modules per MCU differs from chip to chip. Please, read the appropriate datasheet before utilizing this library.

I2Cx_Read

Prototype	<code>unsigned char I2Cx_Read(unsigned ack);</code>
Description	Reads a byte from the I ² C bus.
Parameters	- ack : acknowledge signal parameter. If the ack = 0 , acknowledge signal will be sent after reading, otherwise the not acknowledge signal will be sent.
Returns	Received data.
Requires	MCU with at least one I ² C module. Used I ² C module must be initialized before using this function. See I2Cx_Init routine. Also, START signal needs to be issued in order to use this function. See I2Cx_Start.
Example	<pre>unsigned char take; ... // Read data and send the not_acknowledge signal take = I2C1_Read(1);</pre>
Notes	I ² C library routines require you to specify the module you want to use. To select the desired I ² C module, simply change the letter x in the routine prototype for a number from 1 to 3 . Number of I ² C modules per MCU differs from chip to chip. Please, read the appropriate datasheet before utilizing this library.

I2Cx_Write

Prototype	<code>unsigned I2Cx_Write(unsigned char data_);</code>
Description	Sends data byte via the I ² C bus.
Parameters	- <code>data_</code> : data to be sent
Returns	- 0 if there were no errors. - 1 if write collision was detected on the I ² C bus.
Requires	MCU with at least one I ² C module. Used I ² C module must be initialized before using this function. See I2Cx_Init routine. Also, START signal needs to be issued in order to use this function. See I2Cx_Start.
Example	<pre>unsigned char data_; unsigned error; ... error = I2C1_Write(data_); error = I2C1_Write(0xA3);</pre>
Notes	I ² C library routines require you to specify the module you want to use. To select the desired I ² C module, simply change the letter x in the routine prototype for a number from 1 to 3 . Number of I ² C modules per MCU differs from chip to chip. Please, read the appropriate datasheet before utilizing this library.

I2Cx_Stop

Prototype	<code>void I2Cx_Stop();</code>
Description	Issues STOP signal.
Parameters	None.
Returns	Nothing.
Requires	MCU with at least one I ² C module. Used I ² C module must be initialized before using this function. See I2Cx_Init routine.
Example	<pre>// Issue STOP signal I2C1_Stop();</pre>
Notes	I ² C library routines require you to specify the module you want to use. To select the desired I ² C module, simply change the letter x in the routine prototype for a number from 1 to 3 . Number of I ² C modules per MCU differs from chip to chip. Please, read the appropriate datasheet before utilizing this library.

Library Example

This code demonstrates working with the I²C library. Program sends data to EEPROM (data is written at the address 2). After that, program reads data from the same EEPROM address and displays it on PORTB for visual check. See the figure below how to interface the 24C02 to dsPIC30/33 and PIC24.

Copy Code To Clipboard

```

void main(){
    ADPCFG = 0xFFFF;           // initialize AN pins as digital

    LATB = 0;
    TRISB = 0;                 // Configure PORTB as output

    I2C1_Init(100000);         // initialize I2C communication
    I2C1_Start();              // issue I2C start signal
    I2C1_Write(0xA2);          // send byte via I2C (device address + W)
    I2C1_Write(2);             // send byte (address of EEPROM location)
    I2C1_Write(0xF0);          // send data (data to be written)
    I2C1_Stop();               // issue I2C stop signal

    Delay_100ms();

    I2C1_Start();              // issue I2C start signal
    I2C1_Write(0xA2);          // send byte via I2C (device address + W)
    I2C1_Write(2);             // send byte (data address)
    I2C1_Restart();            // issue I2C signal repeated start
    I2C1_Write(0xA3);          // send byte (device address + R)
    LATB = I2C1_Read(0u);      // Read the data (NO acknowledge)
    I2C1_Stop();               // issue I2C stop signal
}

```

HW Connection

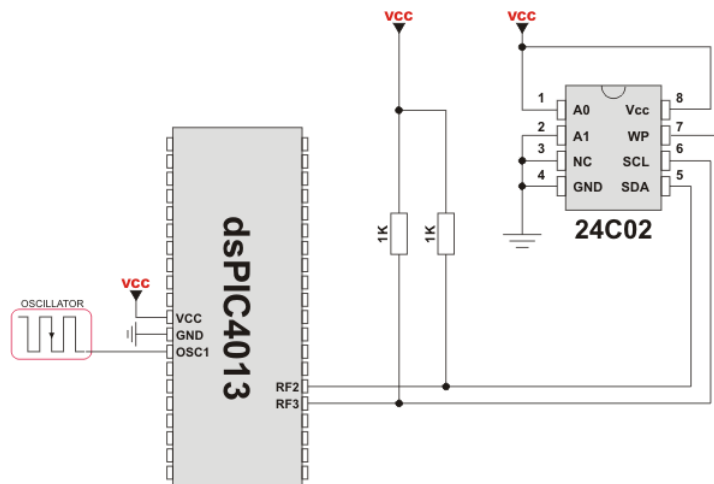

Interfacing 24c02 to dsPIC30/33 and PIC24 via I²C

Keypad Library

The mikroC PRO for dsPIC30/33 and PIC24 provides a library for working with 4x4 keypad. The library routines can also be used with 4x1, 4x2, or 4x3 keypad. For connections explanation see schematic at the bottom of this page.

External dependencies of Keypad Library

The following variable must be defined in all projects using Keypad Library:	Description :	Example :
<code>extern sfr unsigned int keypadPort;</code>	Keypad Port.	<code>unsigned keypadPort at PORTB;</code>

Library Routines

- Keypad_Init
- Keypad_Key_Press
- Keypad_Key_Click

Keypad_Init

Prototype	<code>void Keypad_Init();</code>
Description	Initializes given port for working with keypad.
Parameters	None.
Returns	Nothing.
Requires	Global variable : - <code>keypadPort</code> - Keypad port must be defined before using this function.
Example	<pre>// Keypad module connections char unsigned at PORTB; // End of keypad module connections ... Keypad_Init();</pre>
Notes	The Keypad library uses lower byte (bits <7..0>) of <code>keypadPort</code> .

Keypad_Key_Press

Prototype	<code>unsigned Keypad_Key_Press();</code>
Description	Reads the key from keypad when key gets pressed.
Parameters	None.
Returns	The code of a pressed key (1..16). If no key is pressed, returns 0.
Requires	Port needs to be initialized for working with the Keypad library, see Keypad_Init.
Example	<pre>unsigned kp; ... kp = Keypad_Key_Press();</pre>
Notes	None

Keypad_Key_Click

Prototype	<code>unsigned Keypad_Key_Click();</code>
Description	Call to <code>Keypad_Key_Click</code> is a blocking call: the function waits until some key is pressed and released. When released, the function returns 1 to 16, depending on the key. If more than one key is pressed simultaneously the function will wait until all pressed keys are released. After that the function will return the code of the first pressed key.
Parameters	None.
Returns	The code of a clicked key (1..16). If no key is clicked, returns 0.
Requires	Port needs to be initialized for working with the Keypad library, see Keypad_Init.
Example	<pre>kp = Keypad_Key_Click();</pre>
Notes	None

Library Example

The following code can be used for testing the keypad. It is written for keypad_4x3 or _4x4. The code returned by the keypad functions (1..16) is transformed into ASCII codes [0..9,A..F], and then sent via UART1.

Copy Code To Clipboard

```

unsigned short kp, oldstate = 0;
char txt[6];

// Keypad module connections
unsigned keypadPort at PORTB;
unsigned keypadPort_Direction at TRISB;
// End Keypad module connections

void main() {
    ADPCFG = 0xFFFF;
    UART1_Init(9600);
    Delay_ms(100);
    Keypad_Init(); // Initialize Keypad

    do {
        kp = 0; // Reset key code variable

        // Wait for key to be pressed and released
        do
            // kp = Keypad_Key_Press(); // Store key code in kp variable
            kp = Keypad_Key_Click(); // Store key code in kp variable
        while (!kp);
        // Prepare value for output, transform key to it's ASCII value
        switch (kp) {
            //case 10: kp = 42; break; // '*' // Uncomment this block for keypad4x3
            //case 11: kp = 48; break; // '0'
            //case 12: kp = 35; break; // '#'
            //default: kp += 48;

            case 1: kp = 49; break; // 1 // Uncomment this block for keypad4x4
            case 2: kp = 50; break; // 2
            case 3: kp = 51; break; // 3
            case 4: kp = 65; break; // A
            case 5: kp = 52; break; // 4
            case 6: kp = 53; break; // 5
            case 7: kp = 54; break; // 6
            case 8: kp = 66; break; // B
            case 9: kp = 55; break; // 7
            case 10: kp = 56; break; // 8
            case 11: kp = 57; break; // 9
            case 12: kp = 67; break; // C
            case 13: kp = 42; break; // *
            case 14: kp = 48; break; // 0
            case 15: kp = 35; break; // #
            case 16: kp = 68; break; // D

        }
        UART1_Write(kp); // Send value of pressed button to UART
    } while (1);
}

```

HW Connection

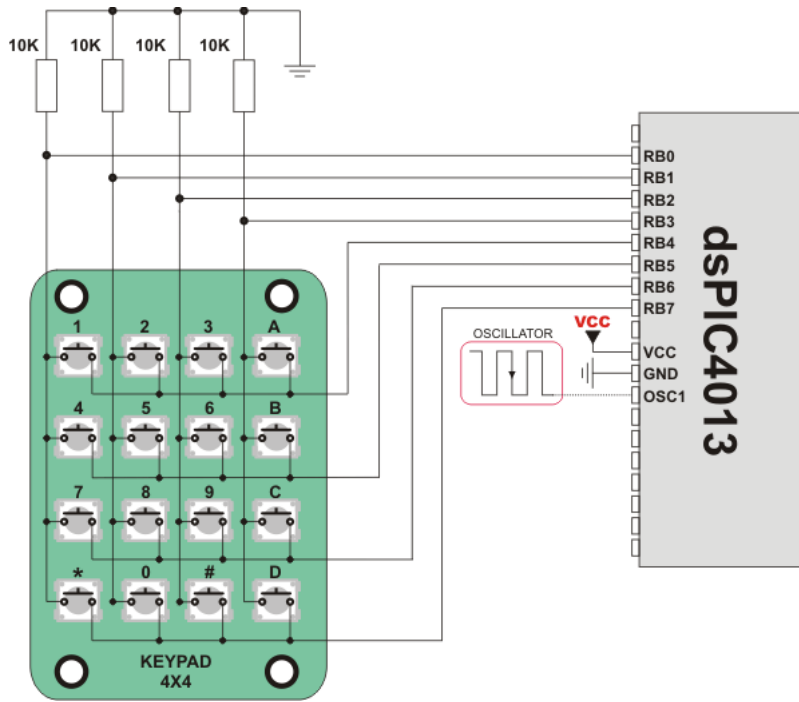

4x4 Keypad connection scheme

Lcd Library

The mikroC PRO for dsPIC30/33 and PIC24 provides a library for communication with Lcds (with HD44780 compliant controllers) through the 4-bit interface. An example of Lcd connections is given on the schematic at the bottom of this page.

For creating a set of custom Lcd characters use Lcd Custom Character Tool.

Library Dependency Tree



Keypad_Key_Click

The following variables must be defined in all projects using Lcd Library :	Description :	Example :
<code>extern sfr sbit LCD_RS;</code>	Register Select line.	<code>sbit LCD_RS at LATD0_bit;</code>
<code>extern sfr sbit LCD_EN;</code>	Enable line.	<code>sbit LCD_EN at LATD1_bit;</code>
<code>extern sfr sbit LCD_D4;</code>	Data 4 line.	<code>sbit LCD_D4 at LATB0_bit;</code>
<code>extern sfr sbit LCD_D5;</code>	Data 5 line.	<code>sbit LCD_D5 at LATB1_bit;</code>
<code>extern sfr sbit LCD_D6;</code>	Data 6 line.	<code>sbit LCD_D6 at LATB2_bit;</code>
<code>extern sfr sbit LCD_D7;</code>	Data 7 line.	<code>sbit LCD_D7 at LATB3_bit;</code>
<code>extern sfr sbit LCD_RS_Direction;</code>	Register Select direction pin.	<code>sbit LCD_RS_Direction at TRISD0_bit;</code>
<code>extern sfr sbit LCD_EN_Direction;</code>	Enable direction pin.	<code>sbit LCD_EN_Direction at TRISD1_bit;</code>
<code>extern sfr sbit LCD_D4_Direction;</code>	Data 4 direction pin.	<code>sbit LCD_D4_Direction at TRISB0_bit;</code>
<code>extern sfr sbit LCD_D5_Direction;</code>	Data 5 direction pin.	<code>sbit LCD_D5_Direction at TRISB1_bit;</code>
<code>extern sfr sbit LCD_D6_Direction;</code>	Data 6 direction pin.	<code>sbit LCD_D6_Direction at TRISB2_bit;</code>
<code>extern sfr sbit LCD_D7_Direction;</code>	Data 7 direction pin.	<code>sbit LCD_D7_Direction at TRISB3_bit;</code>

Library Routines

- Lcd_Init
- Lcd_Out
- Lcd_Out_Cp
- Lcd_Chr
- Lcd_Chr_Cp
- Lcd_Cmd

Lcd_Init

Prototype	<code>void Lcd_Init();</code>
Description	Initializes Lcd module.
Parameters	None.
Returns	Nothing.
Requires	<p>Global variables:</p> <ul style="list-style-type: none"> - <code>LCD_RS</code>: Register Select (data/instruction) signal pin - <code>LCD_EN</code>: Enable signal pin - <code>LCD_D4</code>: Data bit 4 - <code>LCD_D5</code>: Data bit 5 - <code>LCD_D6</code>: Data bit 6 - <code>LCD_D7</code>: Data bit 7 <ul style="list-style-type: none"> - <code>LCD_RS_Direction</code>: Direction of the Register Select pin - <code>LCD_EN_Direction</code>: Direction of the Enable signal pin - <code>LCD_D4_Direction</code>: Direction of the Data 4 pin - <code>LCD_D5_Direction</code>: Direction of the Data 5 pin - <code>LCD_D6_Direction</code>: Direction of the Data 6 pin - <code>LCD_D7_Direction</code>: Direction of the Data 7 pin <p>must be defined before using this function.</p>
Example	<pre>// Lcd module connections sbit LCD_RS at LATD0_bit; sbit LCD_EN at LATD1_bit; sbit LCD_D4 at LATB0_bit; sbit LCD_D5 at LATB1_bit; sbit LCD_D6 at LATB2_bit; sbit LCD_D7 at LATB3_bit; sbit LCD_RS_Direction at TRISD0_bit; sbit LCD_EN_Direction at TRISD1_bit; sbit LCD_D4_Direction at TRISB0_bit; sbit LCD_D5_Direction at TRISB1_bit; sbit LCD_D6_Direction at TRISB2_bit; sbit LCD_D7_Direction at TRISB3_bit; // End Lcd module connections ... Lcd_Init();</pre>
Notes	None

Lcd_Out

Prototype	<code>void Lcd_Out(unsigned int row, unsigned int column, char *text);</code>
Description	Prints text on Lcd starting from specified position. Both string variables and literals can be passed as a text.
Parameters	- <code>row</code> : starting position row number - <code>column</code> : starting position column number - <code>text</code> : text to be written
Returns	Nothing.
Requires	The Lcd module needs to be initialized. See Lcd_Init routine.
Example	<pre>// Write text "Hello!" on Lcd starting from row 1, column 3: Lcd_Out(1, 3, "Hello!");</pre>
Notes	None

Lcd_Out_Cp

Prototype	<code>void Lcd_Out_Cp(char *text);</code>
Returns	Nothing.
Description	Prints text on Lcd at current cursor position. Both string variables and literals can be passed as a text.
Parameters	- <code>text</code> : text to be written
Requires	The Lcd module needs to be initialized. See Lcd_Init routine.
Example	<pre>// Write text "Here!" at current cursor position: Lcd_Out_Cp("Here!");</pre>
Notes	None

Lcd_Chr

Prototype	<code>void Lcd_Chr(unsigned int row, unsigned int column, char out_char);</code>
Description	Prints character on Lcd at specified position. Both variables and literals can be passed as a character.
Parameters	- <code>row</code> : writing position row number - <code>column</code> : writing position column number - <code>out_char</code> : character to be written
Returns	Nothing.
Requires	The Lcd module needs to be initialized. See Lcd_Init routine.
Example	<pre>// Write character "i" at row 2, column 3: Lcd_Chr(2, 3, 'i');</pre>
Notes	None

Lcd_Chr_Cp

Prototype	<code>void Lcd_Chr_Cp(char out_char);</code>
Description	Prints character on Lcd at current cursor position. Both variables and literals can be passed as a character.
Parameters	- <code>out_char</code> : character to be written
Returns	Nothing.
Requires	The Lcd module needs to be initialized. See Lcd_Init routine.
Example	<pre>// Write character "e" at current cursor position: Lcd_Chr_Cp('e');</pre>
Notes	None

Lcd_Cmd

Prototype	<code>void Lcd_Cmd(char out_char);</code>
Description	Sends command to Lcd.
Parameters	- <code>out_char</code> : command to be sent
Returns	Nothing.
Requires	The Lcd module needs to be initialized. See Lcd_Init table.
Example	<pre>// Clear Lcd display: Lcd_Cmd(_LCD_CLEAR);</pre>
Notes	Predefined constants can be passed to the function, see Available Lcd Commands.

Available Lcd Commands

Lcd Command	Purpose
<code>_LCD_FIRST_ROW</code>	Move cursor to the 1st row
<code>_LCD_SECOND_ROW</code>	Move cursor to the 2nd row
<code>_LCD_THIRD_ROW</code>	Move cursor to the 3rd row
<code>_LCD_FOURTH_ROW</code>	Move cursor to the 4th row
<code>_LCD_CLEAR</code>	Clear display
<code>_LCD_RETURN_HOME</code>	Return cursor to home position, returns a shifted display to its original position. Display data RAM is unaffected.
<code>_LCD_CURSOR_OFF</code>	Turn off cursor
<code>_LCD_UNDERLINE_ON</code>	Underline cursor on
<code>_LCD_BLINK_CURSOR_ON</code>	Blink cursor on
<code>_LCD_MOVE_CURSOR_LEFT</code>	Move cursor left without changing display data RAM
<code>_LCD_MOVE_CURSOR_RIGHT</code>	Move cursor right without changing display data RAM
<code>_LCD_TURN_ON</code>	Turn Lcd display on
<code>_LCD_TURN_OFF</code>	Turn Lcd display off
<code>_LCD_SHIFT_LEFT</code>	Shift display left without changing display data RAM
<code>_LCD_SHIFT_RIGHT</code>	Shift display right without changing display data RAM

Library Example

The following code demonstrates usage of the Lcd Library routines:

Copy Code To Clipboard

```
// LCD module connections
sbit LCD_RS at LATD0_bit;
sbit LCD_EN at LATD1_bit;
sbit LCD_D4 at LATB0_bit;
sbit LCD_D5 at LATB1_bit;
sbit LCD_D6 at LATB2_bit;
sbit LCD_D7 at LATB3_bit;

sbit LCD_RS_Direction at TRISD0_bit;
sbit LCD_EN_Direction at TRISD1_bit;
sbit LCD_D4_Direction at TRISB0_bit;
sbit LCD_D5_Direction at TRISB1_bit;
sbit LCD_D6_Direction at TRISB2_bit;
sbit LCD_D7_Direction at TRISB3_bit;
// End LCD module connections

char txt1[] = "mikroElektronika";
char txt2[] = "EasydsPIC4A";
char txt3[] = "Lcd4bit";
char txt4[] = "example";

char i; // Loop variable

void Move_Delay() { // Function used for text moving
    Delay_ms(500); // You can change the moving speed here
}

void main(){
    ADPCFG = 0xFFFF; // Configure AN pins as digital I/O

    Lcd_Init(); // Initialize LCD

    Lcd_Cmd(_LCD_CLEAR); // Clear display
    Lcd_Cmd(_LCD_CURSOR_OFF); // Cursor off
    Lcd_Out(1,6,txt3); // Write text in first row

    Lcd_Out(2,6,txt4); // Write text in second row
    Delay_ms(2000);
    Lcd_Cmd(_LCD_CLEAR); // Clear display

    Lcd_Out(1,1,txt1); // Write text in first row
    Lcd_Out(2,5,txt2); // Write text in second row

    Delay_ms(2000);
}
```

```

// Moving text
for(i=0; i<4; i++) { // Move text to the right 4 times
    Lcd_Cmd(_LCD_SHIFT_RIGHT);
    Move_Delay();
}

while(1) { // Endless loop
    for(i=0; i<8; i++) { // Move text to the left 7 times
        Lcd_Cmd(_LCD_SHIFT_LEFT);
        Move_Delay();
    }

    for(i=0; i<8; i++) { // Move text to the right 7 times
        Lcd_Cmd(_LCD_SHIFT_RIGHT);
        Move_Delay();
    }
}
}

```

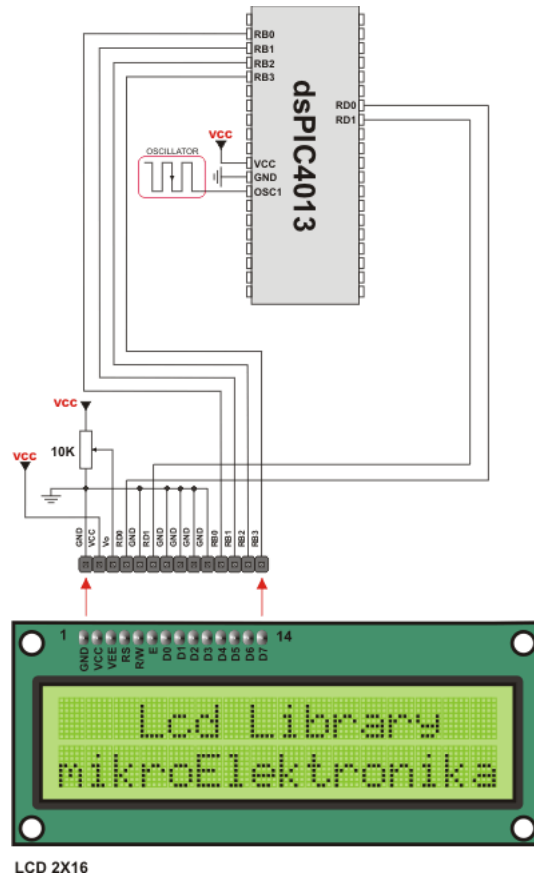

Lcd HW connection

Manchester Code Library

The mikroC PRO for dsPIC30/33 and PIC24 provides a library for handling Manchester coded signals. The Manchester code is a code in which data and clock signals are combined to form a single self-synchronizing data stream; each encoded bit contains a transition at the midpoint of a bit period, the direction of transition determines whether the bit is 0 or 1; the second half is the true bit value and the first half is the complement of the true bit value (as shown in the figure below).

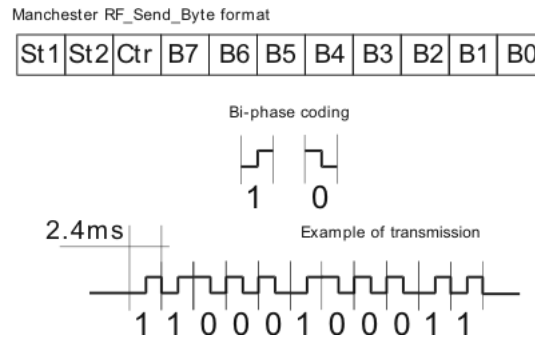

Important :

- The Manchester receive routines are blocking calls ([Man_Receive_Init](#) and [Man_Synchro](#)). This means that MCU will wait until the task has been performed (e.g. byte is received, synchronization achieved, etc).
- Manchester code library implements time-based activities, so interrupts need to be disabled when using it.

Keypad_Key_Click

The following variables must be defined in all projects using Manchester Code Library:	Description :	Example :
<code>extern sfr sbit MANRXPIN;</code>	Receive line.	<code>sbit MANRXPIN at RF0_bit;</code>
<code>extern sfr sbit MANTXPIN;</code>	Transmit line.	<code>sbit MANTXPIN at LATF1_bit;</code>
<code>extern sfr sbit MANRXPIN_Direction;</code>	Direction of the Receive pin.	<code>sbit MANRXPIN_Direction at TRISF0_bit;</code>
<code>extern sfr sbit MANTXPIN_Direction;</code>	Direction of the Transmit pin.	<code>sbit MANTXPIN_Direction at TRISF1_bit;</code>

Library Routines

- Man_Receive_Init
- Man_Receive
- Man_Send_Init
- Man_Send
- Man_Synchro
- Man_Break

The following routines are for the internal use by compiler only:

- Manchester_0
- Manchester_1
- Manchester_Out

Man_Receive_Init

Prototype	<code>unsigned int Man_Receive_Init();</code>
Description	The function configures Receiver pin. After that, the function performs synchronization procedure in order to retrieve baud rate out of the incoming signal.
Parameters	None.
Returns	- 0 - if initialization and synchronization were successful. - 1 - upon unsuccessful synchronization. - 255 - upon user abort.
Requires	Global variables : - <code>MANRXPIN</code> : Receive line - <code>MANRXPIN_Direction</code> : Direction of the receive pin must be defined before using this function.
Example	<pre>` Initialize Receiver sbit MANRXPIN at RF0_bit; sbit MANRXPIN_Direction at TRISF0s_bit; ... if (Man_Receive_Init() == 0) { ... }</pre>
Notes	In case of multiple persistent errors on reception, the user should call this routine once again or <code>Man_Synchro</code> routine to enable synchronization.

Man_Receive

Prototype	<code>unsigned char Man_Receive(unsigned int *error);</code>
Description	The function extracts one byte from incoming signal.
Parameters	- <code>error</code> : error flag. If signal format does not match the expected, the <code>error</code> flag will be set to non-zero.
Returns	A byte read from the incoming signal.
Requires	To use this function, the user must prepare the MCU for receiving. See <code>Man_Receive_Init</code> routines.
Example	<pre> unsigned int data = 0, error = 0; ... data = Man_Receive(&error); if (error) { /* error handling */ } </pre>
Notes	None.

Man_Send_Init

Prototype	<code>void Man_Send_Init();</code>
Description	The function configures Transmitter pin.
Parameters	None.
Returns	Nothing.
Requires	Global variables : - <code>MANTXPIN</code> : Transmit line - <code>MANTXPIN_Direction</code> : Direction of the transmit pin must be defined before using this function.
Example	<pre> // Initialize Transmitter: sbit MANTXPIN at LATF1_bit; sbit MANTXPIN_Direction at TRISF1_bit; ... Man_Send_Init(); </pre>
Notes	None.

Man_Send

Prototype	<code>void Man_Send(unsigned char tr_data);</code>
Description	Sends one byte.
Parameters	- <code>tr_data</code> : data to be sent
Returns	Nothing.
Requires	To use this function, the user must prepare the MCU for sending. See <code>Man_Send_Init</code> routine.
Example	<pre> unsigned int msg; ... Man_Send(msg); </pre>
Notes	Baud rate used is 500 bps.

Man_Synchro

Prototype	<code>unsigned int Man_Synchro();</code>
Description	Measures half of the manchester bit length with 10us resolution.
Parameters	None.
Returns	0 - if synchronization was not successful. Half of the manchester bit length, given in multiples of 10us - upon successful synchronization.
Requires	To use this function, you must first prepare the MCU for receiving. See <code>Man_Receive_Init</code> .
Example	<pre> unsigned int man_half_bit_len; ... man_half_bit_len = Man_Synchro(); </pre>
Notes	None.

Man_Break

Prototype	<code>void Man_Break();</code>
Description	Man_Receive is blocking routine and it can block the program flow. Call this routine from interrupt to unblock the program execution. This mechanism is similar to WDT.
Parameters	None.
Returns	Nothing.
Requires	Nothing.
Example	<pre> char data1, error, counter = 0; void Timer1Int() org IVT_ADDR_T1INTERRUPT { if (counter >= 20) { Man_Break(); counter = 0; // reset counter } else counter++; // increment counter T1IF_bit = 0; // Clear Timer1 overflow interrupt flag } void main() { ... if (Man_Receive_Init() == 0) { ... } ... // try Man_Receive with blocking prevention mechanism IPC0 = IPC0 0x1000; // Interrupt priority level = 1 T1IE_bit= 1; // Enable Timer1 interrupts T1CON = 0x8030; // Timer1 ON, internal clock FCY, prescaler 1:256 data1 = Man_Receive(&error); T1IE_bit= 0; // Disable Timer1 interrupts } </pre>
Notes	Interrupts should be disabled before using Manchester routines again (see note at the top of this page).

Library Example

The following code is code for the Manchester receiver, it shows how to use the Manchester Library for receiving data:

Copy Code To Clipboard

```
// LCD module connections
sbit LCD_RS at LATD0_bit;
sbit LCD_EN at LATD1_bit;
sbit LCD_D4 at LATB0_bit;
sbit LCD_D5 at LATB1_bit;
sbit LCD_D6 at LATB2_bit;
sbit LCD_D7 at LATB3_bit;

sbit LCD_RS_Direction at TRISD0_bit;
sbit LCD_EN_Direction at TRISD1_bit;
sbit LCD_D4_Direction at TRISB0_bit;
sbit LCD_D5_Direction at TRISB1_bit;
sbit LCD_D6_Direction at TRISB2_bit;
sbit LCD_D7_Direction at TRISB3_bit;
// End LCD module connections

// Manchester module connections
sbit MANRXPIN at RF0_bit;
sbit MANRXPIN_Direction at TRISF0_bit;
sbit MANTXPIN at LATF1_bit;
sbit MANTXPIN_Direction at TRISF1_bit;
// End Manchester module connections

char error, ErrorCount, temp;

void main() {
    ErrorCount = 0;
    ADPCFG = 0xFFFF; // Configure AN pins as digital I/O
    TRISB = 0;
    LATB = 0;

    Lcd_Init(); // Initialize LCD
    Lcd_Cmd(_LCD_CLEAR); // Clear LCD display

    Man_Receive_Init(); // Initialize Receiver

    while (1) { // Endless loop

        Lcd_Cmd(_LCD_FIRST_ROW); // Move cursor to the 1st row

        while (1) { // Wait for the "start" byte
            temp = Man_Receive(&error); // Attempt byte receive
            if (temp == 0x0B) // "Start" byte, see Transmitter example
                break; // We got the starting sequence
            if (error) // Exit so we do not loop forever
                break;
        }
    }
}
```

```

do
{
    temp = Man_Receive(&error);           // Attempt byte receive
    if (error) {                          // If error occurred
        Lcd_Chr_CP('?');                  // Write question mark on LCD
        ErrorCount++;                     // Update error counter
        if (ErrorCount > 20) {            // In case of multiple errors
            temp = Man_Synchro();         // Try to synchronize again
            //Man_Receive_Init(); // Alternative, try to Initialize Receiver again
            ErrorCount = 0;               // Reset error counter
        }
    }
    else {                                  // No error occurred
        if (temp != 0x0E) // If "End" byte was received(see Transmitter example)
            Lcd_Chr_CP(temp); // do not write received byte on LCD
    }
    Delay_ms(25);
}
while (temp != 0x0E); // If "End" byte was received exit do loop
}
}

```

The following code is code for the Manchester receiver, it shows how to use the Manchester Library for receiving data:

Copy Code To Clipboard

```

// Manchester module connections
sbit MANRXPIN at RF0_bit;
sbit MANRXPIN_Direction at TRISF0_bit;
sbit MANTXPIN at LATF1_bit;
sbit MANTXPIN_Direction at TRISF1_bit;
// End Manchester module connections

char index, character;
char s1[] = "mikroElektronika";

void main() {

    ADPCFG = 0xFFFF; // Configure AN pins as digital I/O
    TRISB = 0;
    LATB = 0;

    Man_Send_Init(); // Initialize transmitter

    while (1) { // Endless loop
        Man_Send(0x0B); // Send "start" byte
        Delay_ms(100); // Wait for a while

        character = s1[0]; // Take first char from string
        index = 0; // Initialize index variable
    }
}

```

```

while (character) {           // String ends with zero
  Man_Send(character);       // Send character
  Delay_ms(90);              // Wait for a while
  index++;                   // Increment index variable
  character = s1[index];     // Take next char from string
}
Man_Send(0x0E);              // Send "end" byte
Delay_ms(1000);
}
}

```

Connection Example

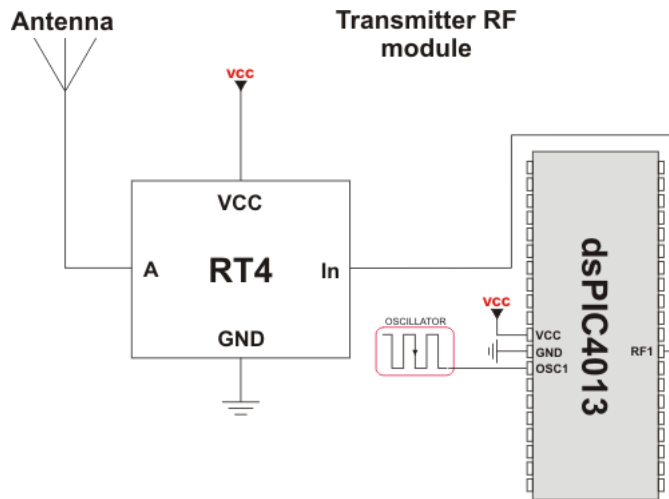

Simple Transmitter connection

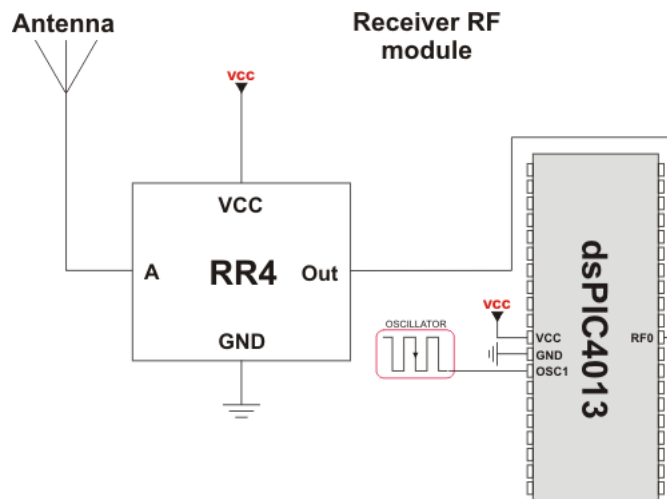

Simple Receiver connection

Multi Media Card Library

The Multi Media Card (MMC) is a Flash memory card standard. MMC cards are currently available in sizes up to and including 32 GB and are used in cellular phones, digital audio players, digital cameras and PDA's. mikroC PRO for dsPIC30/33 and PIC24 provides a library for accessing data on Multi Media Card via SPI communication. This library also supports SD (Secure Digital) and high capacity SDHC (Secure Digital High Capacity) memory cards .

Secure Digital Card

Secure Digital (SD) is a Flash memory card standard, based on the older Multi Media Card (MMC) format. SD cards are currently available in sizes of up to and including 2 GB, and are used in digital cameras, digital camcorders, handheld computers, media players, mobile phones, GPS receivers, video games and PDAs.

Secure Digital High Capacity Card

SDHC (Secure Digital High Capacity, SD 2.0) is an extension of the SD standard which increases card's storage capacity up to 32 GB by using sector addressing instead of byte addressing in the previous SD standard. SDHC cards share the same physical and electrical form factor as older (SD 1.x) cards, allowing SDHC-devices to support both newer SDHC cards and older SD-cards. The current standard limits the maximum capacity of an SDHC card to 32 GB.

Important :

- Routines for file handling can be used only with FAT16 file system.
- Library functions create and read files from the root directory only.
- Library functions populate both FAT1 and FAT2 tables when writing to files, but the file data is being read from the FAT1 table only; i.e. there is no recovery if the FAT1 table gets corrupted.
- If MMC/SD card has Master Boot Record (MBR), the library will work with the first available primary (logical) partition that has non-zero size. If MMC/SD card has Volume Boot Record (i.e. there is only one logical partition and no MBRs), the library works with entire card as a single partition. For more information on MBR, physical and logical drives, primary/secondary partitions and partition tables, please consult other resources, e.g. Wikipedia and similar.
- Before write operation, make sure you don't overwrite boot or FAT sector as it could make your card on PC or digital camera unreadable. Drive mapping tools, such as Winhex, can be of a great assistance.
- Library uses SPI module for communication. The user must initialize the appropriate SPI module before using the MMC Library.
- For MCUs with multiple SPI modules it is possible to initialize all of them and then switch by using the `SPI_Set_Active()` function. See the SPI Library functions.

The SPI module has to be initialized through `SPIx_Init_Advanced` routine with the following parameters:

- SPI Master
- 8bit mode
- secondary prescaler 1
- primary prescaler 64
- Slave Select disabled
- data sampled in the middle of data output time
- clock idle high
- Serial output data changes on transition from active clock state to idle clock state

Tip : Once the MMC/SD card is initialized, SPI module can be reinitialized at higher a speed. See the `Mmc_Init` and `Mmc_Fat_Init` routines.

Library Dependency Tree

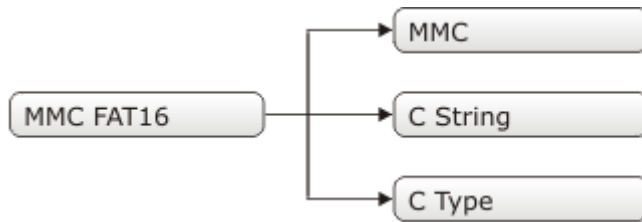

External dependencies of MMC Library

The following variable must be defined in all projects using MMC library:	Description :	Example :
<code>extern sfr sbit Mmc_Chip_Select;</code>	Chip select pin.	<code>sbit Mmc_Chip_Select at LATF0_bit;</code>
<code>extern sfr sbit Mmc_Chip_Select_Direction;</code>	Direction of the chip select pin.	<code>sbit Mmc_Chip_Select_Direction at TRISF0_bit;</code>

Library Routines

- Mmc_Init
- Mmc_Read_Sector
- Mmc_Write_Sector
- Mmc_Read_Cid
- Mmc_Read_Csd

Routines for file handling:

- Mmc_Fat_Init
- Mmc_Fat_QuickFormat
- Mmc_Fat_Assign
- Mmc_Fat_Reset
- Mmc_Fat_Read
- Mmc_Fat_Rewrite
- Mmc_Fat_Append
- Mmc_Fat_Delete
- Mmc_Fat_Write
- Mmc_Fat_Set_File_Date
- Mmc_Fat_Get_File_Date
- Mmc_Fat_Get_File_Date_Modified
- Mmc_Fat_Get_File_Size
- Mmc_Fat_Get_Swap_File

Mmc_Init

Prototype	<code>unsigned int Mmc_Init();</code>
Description	<p>Initializes MMC through hardware SPI interface.</p> <p>Mmc_Init needs to be called before using other functions of this library.</p>
Parameters	None.
Returns	<p>- 0 - if MMC/SD card was detected and successfully initialized</p> <p>- 1 - otherwise</p>
Requires	<p>The appropriate hardware SPI module must be previously initialized.</p> <p>Global variables :</p> <ul style="list-style-type: none"> - Mmc_Chip_Select: Chip Select line - Mmc_Chip_Select_Direction: Direction of the Chip Select pin <p>must be defined before using this function.</p>
Example	<pre>// MMC module connections sbit Mmc_Chip_Select at LATF0_bit; sbit Mmc_Chip_Select_Direction at TRISF0_bit; // MMC module connections ... // Initialize the SPI module SPI1_Init_Advanced(_SPI_MASTER, _SPI_8_BIT, _SPI_PRESCALE_SEC_1, _SPI_ PRESCALE_PRI_64, _SPI_SS_DISABLE, _SPI_DATA_SAMPLE_MIDDLE, _SPI_CLK_IDLE_HIGH, _SPI_ACTIVE_2_ IDLE); // Loop until MMC is initialized while (Mmc_Init()) ; // Reinitialize the SPI module at higher speed (change primary prescaler). SPI1_Init_Advanced(_SPI_MASTER, _SPI_8_BIT, _SPI_PRESCALE_SEC_1, _SPI_ PRESCALE_PRI_4, _SPI_SS_DISABLE, _SPI_DATA_SAMPLE_MIDDLE, _SPI_CLK_IDLE_HIGH, _SPI_ACTIVE_2_ IDLE);</pre>
Notes	None.

Mmc_Read_Sector

Prototype	<code>unsigned int Mmc_Read_Sector(unsigned long sector, char *dbuf);</code>
Description	The function reads one sector (512 bytes) from MMC card.
Parameters	- <code>sector</code> : MMC/SD card sector to be read. - <code>dbuf</code> : buffer of minimum 512 bytes in length for data storage.
Returns	- 0 - if reading was successful - 1 - if an error occurred
Requires	MMC/SD card must be initialized. See <code>Mmc_Init</code> .
Example	<pre>// read sector 510 of the MMC/SD card unsigned int error; unsigned long sectorNo = 510; char dataBuffer[512]; ... error = Mmc_Read_Sector(sectorNo, dataBuffer);</pre>
Notes	None.

Mmc_Write_Sector

Prototype	<code>unsigned int Mmc_Write_Sector(unsigned long sector, char *dbuf);</code>
Description	The function writes 512 bytes of data to one MMC card sector.
Parameters	- <code>sector</code> : MMC/SD card sector to be written to. - <code>dbuf</code> : data to be written (buffer of minimum 512 bytes in length).
Returns	- 0 - if writing was successful - 1 - if there was an error in sending write command - 2 - if there was an error in writing (data rejected)
Requires	MMC/SD card must be initialized. See <code>Mmc_Init</code> .
Example	<pre>// write to sector 510 of the MMC/SD card unsigned int error; unsigned long sectorNo = 510; char dataBuffer[512]; ... error = Mmc_Write_Sector(sectorNo, dataBuffer);</pre>
Notes	None.

Mmc_Read_Cid

Prototype	<code>unsigned int Mmc_Read_Cid(char *data_cid);</code>
Description	The function reads 16-byte CID register.
Parameters	- <code>data_cid</code> : buffer of minimum 16 bytes in length for storing CID register content.
Returns	- 0 - if CID register was read successfully - 1 - if there was an error while reading
Requires	MMC/SD card must be initialized. See <code>Mmc_Init</code> .
Example	<pre>unsigned int error; char dataBuffer[16]; ... error = Mmc_Read_Cid(dataBuffer);</pre>
Notes	None.

Mmc_Read_Csd

Prototype	<code>unsigned int Mmc_Read_Csd(char *data_csd);</code>
Description	The function reads 16-byte CSD register.
Parameters	- <code>data_csd</code> : buffer of minimum 16 bytes in length for storing CSD register content.
Returns	- 0 - if CSD register was read successfully - 1 - if there was an error while reading
Requires	MMC/SD card must be initialized. See <code>Mmc_Init</code> .
Example	<pre>unsigned int error; char dataBuffer[16]; ... error = Mmc_Read_Csd(dataBuffer);</pre>
Notes	None.

Mmc_Fat_Init

Prototype	<code>unsigned int Mmc_Fat_Init();</code>
Description	Initializes MMC/SD card, reads MMC/SD FAT16 boot sector and extracts necessary data needed by the library.
Parameters	None.
Returns	- 0 - if MMC/SD card was detected and successfully initialized - 1 - if FAT16 boot sector was not found - 255 - if MMC/SD card was not detected
Requires	Global variables : - <code>Mmc_Chip_Select</code> : Chip Select line - <code>Mmc_Chip_Select_Direction</code> : Direction of the Chip Select pin must be defined before using this function. The appropriate hardware SPI module must be previously initialized. See the <code>SPIx_Init</code> , <code>SPIx_Init_Advanced</code> routines.
Example	<pre>// MMC module connections sbit Mmc_Chip_Select at LATF0_bit; sbit Mmc_Chip_Select_Direction at TRISF0_bit; // MMC module connections #include <spi_const.h> ... // Initialize the SPI module SPI1_Init_Advanced(_SPI_MASTER, _SPI_8_BIT, _SPI_PRESCALE_SEC_1, _SPI_ PRESCALE_PRI_64, _SPI_SS_DISABLE, _SPI_DATA_SAMPLE_MIDDLE, _SPI_CLK_IDLE_HIGH, _SPI_ACTIVE_2_ IDLE); // Initialize MMC/SD card and MMC_FAT16 library globals Mmc_Fat_Init(); // Reinitialize the SPI module at higher speed (change primary prescaler). SPI1_Init_Advanced(_SPI_MASTER, _SPI_8_BIT, _SPI_PRESCALE_SEC_1, _SPI_ PRESCALE_PRI_4, _SPI_SS_DISABLE, _SPI_DATA_SAMPLE_MIDDLE, _SPI_CLK_IDLE_HIGH, _SPI_ACTIVE_2_ IDLE);</pre>
Notes	MMC/SD card has to be formatted to FAT16 file system.

Mmc_Fat_QuickFormat

Prototype	<code>unsigned int Mmc_Fat_QuickFormat(char *mmc_fat_label);</code>
Description	Formats to FAT16 and initializes MMC/SD card.
Parameters	- <code>mmc_fat_label</code> : volume label (11 characters in length). If less than 11 characters are provided, the label will be padded with spaces. If null string is passed volume will not be labeled
Returns	- 0 - if MMC/SD card was detected, successfully formatted and initialized - 1 - if FAT16 format was unseccessful - 255 - if MMC/SD card was not detected
Requires	The appropriate hardware SPI module must be previously initialized.
Example	<pre>// Initialize the SPI module SPI1_Init_Advanced(_SPI_MASTER, _SPI_8_BIT, _SPI_PRESCALE_SEC_1, _SPI_ PRESCALE_PRI_64, _SPI_SS_DISABLE, _SPI_DATA_SAMPLE_MIDDLE, _SPI_CLK_IDLE_ HIGH, _SPI_ACTIVE_2_IDLE); // Format and initialize MMC/SD card and MMC_FAT16 library globals Mmc_Fat_QuickFormat("mikroE"); // Reinitialize the SPI module at higher speed (change primary prescaler). SPI1_Init_Advanced(_SPI_MASTER, _SPI_8_BIT, _SPI_PRESCALE_SEC_1, _SPI_ PRESCALE_PRI_4, _SPI_SS_DISABLE, _SPI_DATA_SAMPLE_MIDDLE, _SPI_CLK_IDLE_ HIGH, _SPI_ACTIVE_2_IDLE);</pre>
Notes	<p>This routine can be used instead or in conjunction with <code>Mmc_Fat_Init</code> routine.</p> <p>If MMC/SD card already contains a valid boot sector, it will remain unchanged (except volume label field) and only FAT and ROOT tables will be erased. Also, the new volume label will be set.</p>

Mmc_Fat_Assign

Prototype	<code>unsigned int Mmc_Fat_Assign(char *filename, char file_cre_attr);</code>																											
Description	Assigns file for file operations (read, write, delete...). All subsequent file operations will be applied on an assigned file.																											
Parameters	<p>- <code>filename</code>: name of the file that should be assigned for file operations. File name should be in DOS 8.3 (file_name.extension) format. The file name and extension will be automatically padded with spaces by the library if they have less than length required (i.e. "mikro.tx" -> "mikro .tx "), so the user does not have to take care of that. The file name and extension are case insensitive. The library will convert them to proper case automatically, so the user does not have to take care of that.</p> <p>Also, in order to keep backward compatibility with the first version of this library, file names can be entered as UPPERCASE string of 11 bytes in length with no dot character between file name and extension (i.e. "MIKROELETXT" -> MIKROELE.TXT). In this case last 3 characters of the string are considered to be file extension.</p> <p>- <code>file_cre_attr</code>: file creation and attributes flags. Each bit corresponds to the appropriate file attribute:</p> <table border="1" data-bbox="248 638 965 1021"> <thead> <tr> <th>Bit</th> <th>Mask</th> <th>Description</th> </tr> </thead> <tbody> <tr> <td>0</td> <td>0x01</td> <td>Read Only</td> </tr> <tr> <td>1</td> <td>0x02</td> <td>Hidden</td> </tr> <tr> <td>2</td> <td>0x04</td> <td>System</td> </tr> <tr> <td>3</td> <td>0x08</td> <td>Volume Label</td> </tr> <tr> <td>4</td> <td>0x10</td> <td>Subdirectory</td> </tr> <tr> <td>5</td> <td>0x20</td> <td>Archive</td> </tr> <tr> <td>6</td> <td>0x40</td> <td>Device (internal use only, never found on disk)</td> </tr> <tr> <td>7</td> <td>0x80</td> <td>File creation flag. If file does not exist and this flag is set, a new file with specified name will be created.</td> </tr> </tbody> </table>	Bit	Mask	Description	0	0x01	Read Only	1	0x02	Hidden	2	0x04	System	3	0x08	Volume Label	4	0x10	Subdirectory	5	0x20	Archive	6	0x40	Device (internal use only, never found on disk)	7	0x80	File creation flag. If file does not exist and this flag is set, a new file with specified name will be created.
Bit	Mask	Description																										
0	0x01	Read Only																										
1	0x02	Hidden																										
2	0x04	System																										
3	0x08	Volume Label																										
4	0x10	Subdirectory																										
5	0x20	Archive																										
6	0x40	Device (internal use only, never found on disk)																										
7	0x80	File creation flag. If file does not exist and this flag is set, a new file with specified name will be created.																										
Returns	<p>- 1 - if file already exists or file does not exist but a new file is created.</p> <p>- 0 - if file does not exist and no new file is created.</p>																											
Requires	MMC/SD card and MMC library must be initialized for file operations. See Mmc_Fat_Init.																											
Example	<code>// create file with archive attribute if it does not already exist Mmc_Fat_Assign("MIKRO007.TXT", 0xA0);</code>																											
Notes	Long File Names (LFN) are not supported.																											

Mmc_Fat_Reset

Prototype	<code>void Mmc_Fat_Reset(unsigned long *size);</code>
Description	Procedure resets the file pointer (moves it to the start of the file) of the assigned file, so that the file can be read.
Parameters	- <code>size</code> : buffer to store file size to. After file has been opened for reading, its size is returned through this parameter.
Returns	Nothing.
Requires	MMC/SD card and MMC library must be initialized for file operations. See <code>Mmc_Fat_Init</code> . The file must be previously assigned. See <code>Mmc_Fat_Assign</code> .
Example	<pre>unsigned long size; ... Mmc_Fat_Reset(size);</pre>
Notes	None.

Mmc_Fat_Read

Prototype	<code>void Mmc_Fat_Read(unsigned short *bdata);</code>
Description	Reads a byte from the currently assigned file opened for reading. Upon function execution file pointers will be set to the next character in the file.
Parameters	- <code>bdata</code> : buffer to store read byte to. Upon this function execution read byte is returned through this parameter.
Returns	Nothing.
Requires	MMC/SD card and MMC library must be initialized for file operations. See <code>Mmc_Fat_Init</code> . The file must be previously assigned. See <code>Mmc_Fat_Assign</code> . The file must be opened for reading. See <code>Mmc_Fat_Reset</code> .
Example	<pre>char character; ... Mmc_Fat_Read(&character);</pre>
Notes	None.

Mmc_Fat_Rewrite

Prototype	<code>void Mmc_Fat_Rewrite();</code>
Description	Opens the currently assigned file for writing. If the file is not empty its content will be erased.
Parameters	None.
Returns	Nothing.
Requires	MMC/SD card and MMC library must be initialized for file operations. See <code>Mmc_Fat_Init</code> . The file must be previously assigned. See <code>Mmc_Fat_Assign</code> .
Example	<pre>// open file for writing Mmc_Fat_Rewrite();</pre>
Notes	None.

Mmc_Fat_Append

Prototype	<code>void Mmc_Fat_Append();</code>
Description	Opens the currently assigned file for appending. Upon this function execution file pointers will be positioned after the last byte in the file, so any subsequent file write operation will start from there.
Parameters	None.
Returns	Nothing.
Requires	MMC/SD card and MMC library must be initialized for file operations. See <code>Mmc_Fat_Init</code> . The file must be previously assigned. See <code>Mmc_Fat_Assign</code> .
Example	<pre>// open file for appending Mmc_Fat_Append();</pre>
Notes	None.

Mmc_Fat_Delete

Prototype	<code>void Mmc_Fat_Delete();</code>
Description	Deletes currently assigned file from MMC/SD card.
Parameters	None.
Returns	Nothing.
Requires	MMC/SD card and MMC library must be initialized for file operations. See <code>Mmc_Fat_Init</code> . The file must be previously assigned. See <code>Mmc_Fat_Assign</code> .
Example	<pre>// delete current file Mmc_Fat_Delete();</pre>
Notes	None.

Mmc_Fat_Write

Prototype	<code>void Mmc_Fat_Write(char *fdata, unsigned data_len);</code>
Description	Writes requested number of bytes to the currently assigned file opened for writing.
Parameters	- <code>fdata</code> : data to be written. - <code>data_len</code> : number of bytes to be written.
Returns	Nothing.
Requires	MMC/SD card and MMC library must be initialized for file operations. See <code>Mmc_Fat_Init</code> . The file must be previously assigned. See <code>Mmc_Fat_Assign</code> . The file must be opened for writing. See <code>Mmc_Fat_Rewrite</code> or <code>Mmc_Fat_Append</code> .
Example	<pre>char file_contents[42]; ... Mmc_Fat_Write(file_contents, 42); // write data to the assigned file</pre>
Notes	None.

Mmc_Fat_Set_File_Date

Prototype	<code>void Mmc_Fat_Set_File_Date(unsigned int year, unsigned short day, unsigned short hours, unsigned short mins, unsigned short seconds);</code>
Description	Sets the date/time stamp. Any subsequent file write operation will write this stamp to the currently assigned file's time/date attributes.
Parameters	- <code>year</code> : year attribute. Valid values: 1980-2107 - <code>month</code> : month attribute. Valid values: 1-12 - <code>day</code> : day attribute. Valid values: 1-31 - <code>hours</code> : hours attribute. Valid values: 0-23 - <code>mins</code> : minutes attribute. Valid values: 0-59 - <code>seconds</code> : seconds attribute. Valid values: 0-59
Returns	Nothing.
Requires	MMC/SD card and MMC library must be initialized for file operations. See <code>Mmc_Fat_Init</code> . The file must be previously assigned. See <code>Mmc_Fat_Assign</code> . The file must be opened for writing. See <code>Mmc_Fat_Rewrite</code> or <code>Mmc_Fat_Append</code> .
Example	<pre>// April 1st 2005, 18:07:00 Mmc_Fat_Set_File_Date(2005, 4, 1, 18, 7, 0);</pre>
Notes	None.

Mmc_Fat_Get_File_Date

Prototype	<code>void Mmc_Fat_Get_File_Date(unsigned int *year, unsigned short *month, unsigned short *day, unsigned short *hours, unsigned short *mins);</code>
Description	Reads time/date attributes of the currently assigned file.
Parameters	<ul style="list-style-type: none"> - <code>year</code>: buffer to store year attribute to. Upon function execution year attribute is returned through this parameter. - <code>month</code>: buffer to store month attribute to. Upon function execution month attribute is returned through this parameter. - <code>day</code>: buffer to store day attribute to. Upon function execution day attribute is returned through this parameter. - <code>hours</code>: buffer to store hours attribute to. Upon function execution hours attribute is returned through this parameter. - <code>mins</code>: buffer to store minutes attribute to. Upon function execution minutes attribute is returned through this parameter.
Returns	Nothing.
Requires	<p>MMC/SD card and MMC library must be initialized for file operations. See <code>Mmc_Fat_Init</code>.</p> <p>The file must be previously assigned. See <code>Mmc_Fat_Assign</code>.</p>
Example	<pre>// get Date/time of file unsigned yr; char mnth, dat, hrs, mins; ... file_Name = "MYFILEABTXT"; Mmc_Fat_Assign(file_Name); Mmc_Fat_Get_File_Date(&yr, &mnth, &day, &hrs, &mins);</pre>
Notes	None.

Mmc_Fat_Get_File_Date_Modified

Prototype	<code>void Mmc_Fat_Get_File_Date_Modified(unsigned int *year, unsigned short *month, unsigned short *day, unsigned short *hours, unsigned short *mins);</code>
Description	Retrieves the last modification date/time for the currently selected file. Seconds are not being retrieved since they are written in 2-sec increments.
Parameters	<ul style="list-style-type: none"> - <code>year</code>: buffer to store year attribute to. Upon function execution year attribute is returned through this parameter. - <code>month</code>: buffer to store month attribute to. Upon function execution month attribute is returned through this parameter. - <code>day</code>: buffer to store day attribute to. Upon function execution day attribute is returned through this parameter. - <code>hours</code>: buffer to store hours attribute to. Upon function execution hours attribute is returned through this parameter. - <code>mins</code>: buffer to store minutes attribute to. Upon function execution minutes attribute is returned through this parameter.
Returns	Nothing.
Requires	The file must be assigned, see <code>Mmc_Fat_Assign</code> .
Example	<pre>// get modification Date/time of file unsigned yr; char mnth, dat, hrs, mins; ... file_Name = "MYFILEABTXT"; Mmc_Fat_Assign(file_Name); Mmc_Fat_Get_File_Date_Modified(&yr, &mnth, &day, &hrs, &mins);</pre>

Mmc_Fat_Get_File_Size

Prototype	<code>unsigned long Mmc_Fat_Get_File_Size();</code>
Description	This function reads size of the currently assigned file in bytes.
Parameters	None.
Returns	This function returns size of active file (in bytes).
Requires	MMC/SD card and MMC library must be initialized for file operations. See <code>Mmc_Fat_Init</code> . The file must be previously assigned. See <code>Mmc_Fat_Assign</code> .
Example	<pre>unsigned long my_file_size; ... my_file_size = Mmc_Fat_Get_File_Size();</pre>
Notes	None

Mmc_Fat_Get_Swap_File

Prototype	<code>unsigned long Mmc_Fat_Get_Swap_File(unsigned long sectors_cnt, char* filename, char file_attr);</code>																											
Description	<p>This function is used to create a swap file of predefined name and size on the MMC/SD media. If a file with specified name already exists on the media, search for consecutive sectors will ignore sectors occupied by this file. Therefore, it is recommended to erase such file if it already exists before calling this function. If it is not erased and there is still enough space for a new swap file, this function will delete it after allocating new memory space for a new swap file.</p> <p>The purpose of the swap file is to make reading and writing to MMC/SD media as fast as possible, by using the <code>Mmc_Read_Sector()</code> and <code>Mmc_Write_Sector()</code> functions directly, without potentially damaging the FAT system. The swap file can be considered as a “window” on the media where the user can freely write/read data. It’s main purpose in this library is to be used for fast data acquisition; when the time-critical acquisition has finished, the data can be re-written into a “normal” file, and formatted in the most suitable way.</p>																											
Parameters	<p>- <code>sectors_cnt</code>: number of consecutive sectors that user wants the swap file to have.</p> <p>- <code>filename</code>: name of the file that should be assigned for file operations. File name should be in DOS 8.3 (file_name.extension) format. The file name and extension will be automatically padded with spaces by the library if they have less than length required (i.e. “mikro.tx” -> “mikro .tx “), so the user does not have to take care of that. The file name and extension are case insensitive. The library will convert them to proper case automatically, so the user does not have to take care of that.</p> <p>Also, in order to keep backward compatibility with the first version of this library, file names can be entered as UPPERCASE string of 11 bytes in length with no dot character between file name and extension (i.e. “MIKROELETXT” -> MIKROELE.TXT). In this case last 3 characters of the string are considered to be file extension.</p> <p>- <code>file_attr</code>: file creation and attributes flags. Each bit corresponds to the appropriate file attribute:</p> <table border="1" data-bbox="249 930 968 1281"> <thead> <tr> <th>Bit</th> <th>Mask</th> <th>Description</th> </tr> </thead> <tbody> <tr> <td>0</td> <td>0x01</td> <td>Read Only</td> </tr> <tr> <td>1</td> <td>0x02</td> <td>Hidden</td> </tr> <tr> <td>2</td> <td>0x04</td> <td>System</td> </tr> <tr> <td>3</td> <td>0x08</td> <td>Volume Label</td> </tr> <tr> <td>4</td> <td>0x10</td> <td>Subdirectory</td> </tr> <tr> <td>5</td> <td>0x20</td> <td>Archive</td> </tr> <tr> <td>6</td> <td>0x40</td> <td>Device (internal use only, never found on disk)</td> </tr> <tr> <td>7</td> <td>0x80</td> <td>Not used</td> </tr> </tbody> </table>	Bit	Mask	Description	0	0x01	Read Only	1	0x02	Hidden	2	0x04	System	3	0x08	Volume Label	4	0x10	Subdirectory	5	0x20	Archive	6	0x40	Device (internal use only, never found on disk)	7	0x80	Not used
Bit	Mask	Description																										
0	0x01	Read Only																										
1	0x02	Hidden																										
2	0x04	System																										
3	0x08	Volume Label																										
4	0x10	Subdirectory																										
5	0x20	Archive																										
6	0x40	Device (internal use only, never found on disk)																										
7	0x80	Not used																										
Returns	Number of the start sector for the newly created swap file, if there was enough free space on the MMC/SD card to create file of required size. 0 - otherwise.																											
Requires	MMC/SD card and MMC library must be initialized for file operations. See <code>Mmc_Fat_Init</code> .																											

Requires	MMC/SD card and MMC library must be initialized for file operations. See Mmc_Fat_Init.
Example	<pre>//----- Tries to create a swap file, whose size will be at least 100 sectors. //If it succeeds, it sends the No. of start sector over UART void M_Create_Swap_File(){ size = Mmc_Fat_Get_Swap_File(100); if (size <> 0) { UART1_Write(0xAA); UART1_Write(Lo(size)); UART1_Write(Hi(size)); UART1_Write(Higher(size)); UART1_Write(Highest(size)); UART1_Write(0xAA); } }</pre>
Notes	Long File Names (LFN) are not supported.

Library Example

The following example demonstrates usage of the MMC and MMC_FAT routines.

Copy Code To Clipboard

```
// MMC module connections
sbit Mmc_Chip_Select      at LATF0_bit; // for writing to output pin always use latch
sbit Mmc_Chip_Select_Direction at TRISF0_bit;
// eof MMC module connections

const LINE_LEN = 43;
char err_txt[20]      = "FAT16 not found";
char file_contents[LINE_LEN] = "XX MMC/SD FAT16 library by Anton Rieckertn";
char filename[14]    = "MIKRO00x.TXT";           // File names
unsigned short loop, loop2;
unsigned long i, size;
char Buffer[512];

// UART1 write text and new line (carriage return + line feed)
void UART1_Write_Line(char *uart_text) {
    UART1_Write_Text(uart_text);
    UART1_Write(13);
    UART1_Write(10); for(loop = 1; loop <= 99; loop++) {
        UART1_Write('.');
        file_contents[0] = loop / 10 + 48;
        file_contents[1] = loop % 10 + 48;
        Mmc_Fat_Write(file_contents, LINE_LEN-1); // write data to the assigned file
    }
}
```

```

// Creates many new files and writes data to them
void M_Create_Multiple_Files() {
    for(loop2 = 'B'; loop2 <= 'Z'; loop2++) {
        UART1_Write(loop2);           // signal the progress
        filename[7] = loop2;         // set filename
        Mmc_Fat_Set_File_Date(2005,6,21,10,35,0); // Set file date & time info
        Mmc_Fat_Assign(&filename, 0xA0); // find existing file or create a new one
        Mmc_Fat_Rewrite();           // To clear file and start with new data
        for(loop = 1; loop <= 44; loop++) {
            file_contents[0] = loop / 10 + 48;
            file_contents[1] = loop % 10 + 48;
            Mmc_Fat_Write(file_contents, LINE_LEN-1); // write data to the assigned file
        }
    }
}

// Opens an existing file and rewrites it
void M_Open_File_Rewrite() {
    filename[7] = 'C';
    Mmc_Fat_Assign(&filename, 0);
    Mmc_Fat_Rewrite();
    for(loop = 1; loop <= 55; loop++) {
        file_contents[0] = loop / 10 + 65;
        file_contents[1] = loop % 10 + 65;
        Mmc_Fat_Write(file_contents, LINE_LEN-1); // write data to the assigned file
    }
}

// Opens an existing file and appends data to it
// (and alters the date/time stamp)
void M_Open_File_Append() {
    filename[7] = 'B';
    Mmc_Fat_Assign(&filename, 0);
    Mmc_Fat_Set_File_Date(2009, 1, 23, 17, 22, 0);
    Mmc_Fat_Append(); // Prepare file for append
    Mmc_Fat_Write(" for mikroElektronika 2005n", 27); // Write data to assigned file
}

// Opens an existing file, reads data from it and puts it to UART
void M_Open_File_Read() {
    char character;

    filename[7] = 'B';
    Mmc_Fat_Assign(&filename, 0);
    Mmc_Fat_Reset(&size); // To read file, procedure returns size of file
    for (i = 1; i <= size; i++) {
        Mmc_Fat_Read(&character);
        UART1_Write(character); // Write data to UART
    }
}

```

```
// Deletes a file. If file doesn't exist, it will first be created
// and then deleted.
void M_Delete_File() {
    filename[7] = 'F';
    Mmc_Fat_Assign(filename, 0);
    Mmc_Fat_Delete();
}

// Tests whether file exists, and if so sends its creation date
// and file size via UART
void M_Test_File_Exist() {
    unsigned long   fsize;
    unsigned int    year;
    unsigned short  month, day, hour, minute;
    unsigned char   outstr[12];

    filename[7] = 'B';          //uncomment this line to search for file that DOES exists
    // filename[7] = 'F';      //uncomment this line to search for file that DOES NOT
    exist
    if (Mmc_Fat_Assign(filename, 0)) {
        //--- file has been found - get its create date
        Mmc_Fat_Get_File_Date(&year, &month, &day, &hour, &minute);
        UART1_Write_Text(" created: ");
        WordToStr(year, outstr);
        UART1_Write_Text(outstr);
        ByteToStr(month, outstr);
        UART1_Write_Text(outstr);
        WordToStr(day, outstr);
        UART1_Write_Text(outstr);
        WordToStr(hour, outstr);
        UART1_Write_Text(outstr);
        WordToStr(minute, outstr);
        UART1_Write_Text(outstr);

        //--- file has been found - get its modified date
        Mmc_Fat_Get_File_Date_Modified(&year, &month, &day, &hour, &minute);
        UART1_Write_Text(" modified: ");
        WordToStr(year, outstr);
        UART1_Write_Text(outstr);
        ByteToStr(month, outstr);
        UART1_Write_Text(outstr);
        WordToStr(day, outstr);
        UART1_Write_Text(outstr);
        WordToStr(hour, outstr);
        UART1_Write_Text(outstr);
        WordToStr(minute, outstr);
        UART1_Write_Text(outstr);

        //--- get file size
        fsize = Mmc_Fat_Get_File_Size();
        LongToStr((signed long) fsize, outstr);
        UART1_Write_Line(outstr);
    }
}
```

```

else {
    //--- file was not found - signal it
    UART1_Write(0x55);
    Delay_ms(1000);
    UART1_Write(0x55);
}
}

// Tries to create a swap file, whose size will be at least 100
// sectors (see Help for details)
void M_Create_Swap_File() {
    unsigned int i;

    for(i=0; i<512; i++)
        Buffer[i] = i;

    size = Mmc_Fat_Get_Swap_File(5000, "mikroE.txt", 0x20); // see help on this function
    for details

    if (size) {
        LongToStr((signed long)size, err_txt);
        UART1_Write_Line(err_txt);

        for(i=0; i<5000; i++) {
            Mmc_Write_Sector(size++, Buffer);
            UART1_Write('.');
        }
    }
}

//----- Main. Uncomment the function(s) to test the desired operation(s)
void main() {
    #define COMPLETE_EXAMPLE // comment this line to make simpler/smaller example
    PORTD = 0;
    TRISD = 0;
    PORTF = 0;
    TRISF = 0;
    ADPCFG = 0xFFFF; // initialize AN pins as digital
    //--- set up USART for the file read
    SPI1_Init_Advanced(_SPI_MASTER, _SPI_8_BIT, _SPI_PRESCALE_SEC_1, _SPI_PRESCALE_
PRI_64,
        _SPI_SS_DISABLE, _SPI_DATA_SAMPLE_MIDDLE, _SPI_CLK_IDLE_HIGH, _SPI_
ACTIVE_2_IDLE);

    UART1_Init(19200); // Initialize UART module at 9600 bps
    Delay_ms(100); // Wait for UART module to stabilize

```

```

U1MODEbits.ALTIO = 1;    // Switch Rx and Tx pins on their alternate locations.
                        // This is used to free the pins for other module, namely the SPI.
//--- init the FAT library
if (!Mmc_Fat_Init()) {
    // reinitialize spi at higher speed
    SPI1_Init_Advanced(_SPI_MASTER, _SPI_8_BIT, _SPI_PRESCALE_SEC_1, _SPI_PRESCALE_
PRI_4,
                        _SPI_SS_DISABLE, _SPI_DATA_SAMPLE_MIDDLE, _SPI_CLK_IDLE_HIGH,
_SPI_ACTIVE_2_IDLE);
//--- Test start
UART1_Write_Line("Test Start.");
//--- Test routines. Uncomment them one-by-one to test certain features
M_Create_New_File();
#ifdef COMPLETE_EXAMPLE
    M_Create_Multiple_Files();
    M_Open_File_Rewrite();
    M_Open_File_Append();
    M_Open_File_Read();
    M_Delete_File();
    M_Test_File_Exist();
    M_Create_Swap_File();
#endif
UART1_Write_Line("Test End.");
}
else {
    UART1_Write_Line(err_txt); // Note: Mmc_Fat_Init tries to initialize a card more
than once.
                                // If card is not present, initialization may last
longer (depending on clock speed)
}
}
}

```

HW Connection

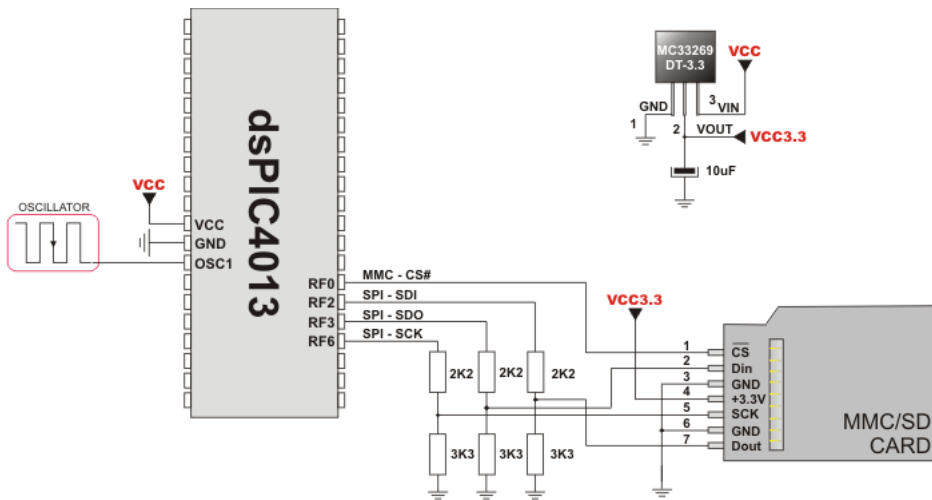

Pin diagram of MMC memory card

OneWire Library

The OneWire library provides routines for communication via the Dallas OneWire protocol, e.g. with DS18x20 digital thermometer. OneWire is a Master/Slave protocol, and all communication cabling required is a single wire. OneWire enabled devices should have open collector drivers (with single pull-up resistor) on the shared data line.

Slave devices on the OneWire bus can even get their power supply from data line. For detailed schematic see device datasheet.

Some basic characteristics of this protocol are:

- single master system,
- low cost,
- low transfer rates (up to 16 kbps),
- fairly long distances (up to 300 meters),
- small data transfer packages.

Each OneWire device also has a unique 64-bit registration number (8-bit device type, 48-bit serial number and 8-bit CRC), so multiple slaves can co-exist on the same bus.

Important :

- Oscillator frequency F_{osc} needs to be at least 4MHz in order to use the routines with Dallas digital thermometers.
- This library implements time-based activities, so interrupts need to be disabled when using OneWire library.

Library Routines

- Ow_Reset
- Ow_Read
- Ow_Write

Ow_Reset

Prototype	<code>unsigned int Ow_Reset(unsigned int *port, unsigned int pin);</code>
Description	Issues OneWire reset signal for DS18x20.
Parameters	- <code>port</code> : OneWire bus port - <code>pin</code> : OneWire bus pin
Returns	- 0 if the device is present - 1 if the device is not present
Requires	Devices compliant with the Dallas OneWire protocol.
Example	<pre>// Issue Reset signal on One-Wire Bus connected to pin RF6 Ow_Reset(&PORTF, 6);</pre>
Notes	None.

Ow_Read

Prototype	<code>unsigned short Ow_Read(unsigned int *port, unsigned int pin);</code>
Description	Reads one byte of data via the OneWire bus.
Parameters	- <code>port</code> : OneWire bus port - <code>pin</code> : OneWire bus pin
Returns	Data read from an external device over the OneWire bus.
Requires	Devices compliant with the Dallas OneWire protocol.
Example	<pre>// Read a byte from the One-Wire Bus connected to pin RF6 unsigned short read_data; ... read_data = Ow_Read(&PORTF, 6);</pre>
Notes	None.

Ow_Write

Prototype	<code>void Ow_Write(unsigned int *port, unsigned int pin, unsigned short data_);</code>
Description	Writes one byte of data via the OneWire bus.
Parameters	- <code>port</code> : OneWire bus port - <code>pin</code> : OneWire bus pin - <code>data_</code> : data to be written
Returns	Nothing.
Requires	Devices compliant with the Dallas OneWire protocol.
Example	<pre>// Send a byte to the One-Wire Bus connected to pin RF6 Ow_Write(&PORTF, 6, 0xCC);</pre>
Notes	None.

Library Example

This example reads the temperature using DS18x20 connected to pin RF6. After reset, MCU obtains temperature from the sensor and prints it on the Lcd. Be sure to set Fosc appropriately in your project, to pull-up RF6 line and to turn off the PORTF leds.

Copy Code To Clipboard

```
// LCD module connections
sbit LCD_RS at LATB4_bit;
sbit LCD_EN at LATB6_bit;
sbit LCD_D4 at LATD4_bit;
sbit LCD_D5 at LATD5_bit;
sbit LCD_D6 at LATD6_bit;
sbit LCD_D7 at LATD7_bit;

sbit LCD_RS_Direction at TRISB4_bit;
sbit LCD_EN_Direction at TRISB6_bit;
sbit LCD_D4_Direction at TRISD4_bit;
sbit LCD_D5_Direction at TRISD5_bit;
sbit LCD_D6_Direction at TRISD6_bit;
sbit LCD_D7_Direction at TRISD7_bit;
// End LCD module connections

// Set TEMP_RESOLUTION to the corresponding resolution of used DS18x20 sensor:
// 18S20: 9 (default setting; can be 9,10,11,or 12)
// 18B20: 12
const unsigned short TEMP_RESOLUTION = 9;

char *text = "000.0000";
unsigned temp;

void Display_Temperature(unsigned int temp2write) {
    const unsigned short RES_SHIFT = TEMP_RESOLUTION - 8;
    char temp_whole;
    unsigned int temp_fraction;

    // check if temperature is negative
    if (temp2write & 0x8000) {
        text[0] = '-';
        temp2write = ~temp2write + 1;
    }

    // extract temp_whole
    temp_whole = temp2write >> RES_SHIFT ;

    // convert temp_whole to characters
    if (temp_whole/100)
        text[0] = temp_whole/100 + 48;
    else
        text[0] = '0';
```

```
text[1] = (temp_whole/10)%10 + 48;           // Extract tens digit
text[2] = temp_whole%10    + 48;           // Extract ones digit

// extract temp_fraction and convert it to unsigned int
temp_fraction = temp2write << (4-RES_SHIFT);
temp_fraction &= 0x000F;
temp_fraction *= 625;

// convert temp_fraction to characters
text[4] = temp_fraction/1000    + 48;     // Extract thousands digit
text[5] = (temp_fraction/100)%10 + 48;    // Extract hundreds digit
text[6] = (temp_fraction/10)%10  + 48;    // Extract tens digit
text[7] = temp_fraction%10      + 48;    // Extract ones digit

// print temperature on LCD
Lcd_Out(2, 5, text);
}

void main() {

    ADPCFG = 0xFFFF;                       // Configure AN pins as digital

    Lcd_Init();                             // Initialize LCD
    Lcd_Cmd(_LCD_CLEAR);                    // Clear LCD
    Lcd_Cmd(_LCD_CURSOR_OFF);              // Turn cursor off
    Lcd_Out(1, 1, " Temperature:  ");
    // Print degree character, 'C' for Centigrades
    Lcd_Chrc(2,13,223); // different LCD displays have different char code for degree
                        // if you see greek alpha letter try typing 178 instead of 223

    Lcd_Chrc(2,14,'C');

    //--- main loop
    do {
        //--- perform temperature reading
        Ow_Reset(&PORTF, 6);                 // Onewire reset signal
        Ow_Write(&PORTF, 6, 0xCC);          // Issue command SKIP_ROM
        Ow_Write(&PORTF, 6, 0x44);          // Issue command CONVERT_T
        Delay_us(120);

        Ow_Reset(&PORTF, 6);
        Ow_Write(&PORTF, 6, 0xCC);          // Issue command SKIP_ROM
        Ow_Write(&PORTF, 6, 0xBE);          // Issue command READ_SCRATCHPAD
        Delay_ms(400);

        temp = Ow_Read(&PORTF, 6);
        temp = (Ow_Read(&PORTF, 6) << 8) + temp;

        //--- Format and display result on Lcd
        Display_Temperature(temp);

        Delay_ms(500);
    } while (1);
}
```

HW Connection

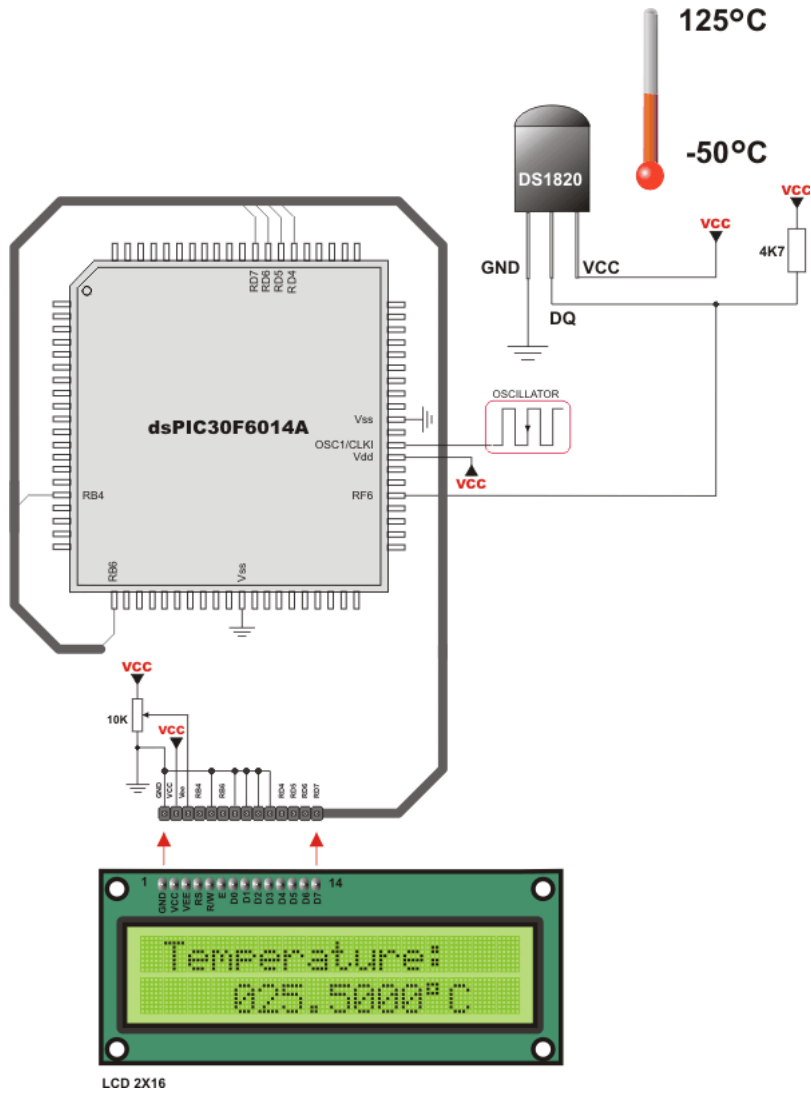

Example of DS1820 connection

Peripheral Pin Select Library

The Peripheral Pin Select library enables user to have more than one digital peripheral multiplexed on a single pin. Users may independently map the input and/or output of any one of many digital peripherals to any one of these I/O pins.

The peripherals managed by the Peripheral Pin Select library are all digital only peripherals.

A key difference between pin select and non pin select peripherals is that pin select peripherals are not associated with a default I/O pin. The peripheral must always be assigned to a specific I/O pin before it can be used.

In contrast, non pin select peripherals are always available on a default pin, assuming that the peripheral is active and not conflicting with another peripheral.

When a pin selectable peripheral is active on a given I/O pin, it takes priority over all other digital I/O and digital communication peripherals associated with the pin.

Important : Before using any of the digital peripherals or its library routines, user must set the desired pins as input/output and assign the desired peripheral to these pins.

Library Routines

- Unlock_IOLOCK
- Lock_IOLOCK
- PPS_Mapping

Unlock_IOLOCK

Prototype	<code>void Unlock_IOLOCK();</code>
Description	Unlocks I/O pins for Peripheral Pin Mapping.
Parameters	None.
Returns	Nothing.
Requires	Nothing.
Example	<code>Unlock_IOLOCK();</code>
Notes	None.

Lock_IOLOCK

Prototype	<code>void Lock_IOLOCK();</code>
Description	Locks I/O pins for Peripheral Pin Mapping.
Parameters	None.
Returns	Nothing.
Requires	Nothing.
Example	<code>Lock_IOLOCK();</code>

PPS_Mapping

Prototype	<code>unsigned PPS_Mapping(unsigned short rp_num, unsigned short direction, unsigned short funct_name);</code>
Description	Sets desired internal MCU module to be mapped on the requested pins.
Parameters	<ul style="list-style-type: none"> - <code>rp_num</code>: Remappable pin number. Consult the appropriate datasheet for adequate values. - <code>direction</code>: Sets requested pin to be used as an input or output. See Direction Parameters for adequate values. - <code>funct_name</code>: Selects internal MCU module function for usage. See Input Functions or Output Functions for adequate values.
Returns	<ul style="list-style-type: none"> - 0 - if non-existing peripheral pin is selected. - 1 - if desired function is not implemented for the chosen MCU. - 2 - if any of the other RPOUT registers is configured to output the SCK1OUT function while SCK1CM is set (only for P24FJ256GA110 Family). - 255 - if peripheral pin mapping was successful.
Requires	Nothing.
Example	<pre>PPS_Mapping(15, _INPUT, _RX2_DT2) // Sets pin 15 to be Input, and maps RX2/DT2 Input to it PPS_Mapping(5, _OUTPUT, _TX2_CK2); // Sets pin 5 to be Output, and maps EUSART2 Asynchronous Transmit/Synchronous Clock Output to it</pre>
Notes	None.

Direction Parameters

Direction Parameter	Description
<code>_INPUT</code>	Sets selected pin as input
<code>_OUTPUT</code>	Sets selected pin as output

Input Functions

Function Name	Description
<code>_CIRX</code>	ECAN1 Receive
<code>_COFSI</code>	DCI Frame Sync Input
<code>_CCKI</code>	DCI Serial Clock Input
<code>_CSDI</code>	DCI Serial Data Input
<code>_FLTA1</code>	PWM1 Fault
<code>_FLTA2</code>	PWM2 Fault
<code>_FLTA3</code>	PWM3 Fault
<code>_FLTA4</code>	PWM4 Fault
<code>_FLTA5</code>	PWM5 Fault
<code>_FLTA6</code>	PWM6 Fault
<code>_FLTA7</code>	PWM7 Fault
<code>_FLTA8</code>	PWM8 Fault
<code>_IC1</code>	Input Capture 1

<code>_IC2</code>	Input Capture 2
<code>_IC3</code>	Input Capture 3
<code>_IC4</code>	Input Capture 4
<code>_IC5</code>	Input Capture 5
<code>_IC6</code>	Input Capture 6
<code>_IC7</code>	Input Capture 7
<code>_IC8</code>	Input Capture 8
<code>_IC9</code>	Input Capture 9
<code>_INDX1</code>	QE1 Index
<code>_INDX2</code>	QE2 Index
<code>_INT1</code>	External Interrupt 1
<code>_INT2</code>	External Interrupt 2
<code>_INT3</code>	External Interrupt 3
<code>_INT4</code>	External Interrupt 4

<code>_QE1</code>	QE1 Phase A
<code>_QE2</code>	QE12 Phase A
<code>_QEB1</code>	QE1 Phase B
<code>_QEB2</code>	QE12 Phase B
<code>_SCK1IN</code>	SPI1 Clock Input
<code>_SCK2IN</code>	SPI2 Clock Input
<code>_SCK3IN</code>	SPI3 Clock Input
<code>_SDI1</code>	SPI1 Data Input
<code>_SDI2</code>	SPI2 Data Input
<code>_SDI3</code>	SPI3 Data Input
<code>_SS1IN</code>	SPI1 Slave Select Input
<code>_SS2IN</code>	SPI2 Slave Select Input
<code>_SS3IN</code>	SPI3 Slave Select Input

<code>_T1CK</code>	Timer1 External Clock
<code>_T2CK</code>	Timer2 External Clock
<code>_T3CK</code>	Timer3 External Clock
<code>_T4CK</code>	Timer4 External Clock
<code>_T5CK</code>	Timer5 External Clock
<code>_U1CTS</code>	UART1 Clear To Send
<code>_U2CTS</code>	UART2 Clear To Send
<code>_U3CTS</code>	UART3 Clear To Send
<code>_U4CTS</code>	UART4 Clear To Send
<code>_U1RX</code>	UART1 Receive
<code>_U2RX</code>	UART2 Receive
<code>_U3RX</code>	UART3 Receive
<code>_U4RX</code>	UART4 Receive

Output Functions

Function Name	Description
<code>_NULL</code>	The NULL function is assigned to all RPN outputs at device Reset and disables the RPN output function.
<code>_ACMP1</code>	RPN tied to Analog Comparator Output 1
<code>_ACMP2</code>	RPN tied to Analog Comparator Output 2
<code>_ACMP3</code>	RPN tied to Analog Comparator Output 3
<code>_ACMP4</code>	RPN tied to Analog Comparator Output 4
<code>_C1OUT</code>	Comparator 1 Output
<code>_C2OUT</code>	Comparator 2 Output
<code>_C3OUT</code>	Comparator 3 Output
<code>_COFSOS</code>	DCI Frame Sync Output
<code>_CSCKO</code>	DCI Serial Clock Output
<code>_CSDO</code>	DCI Serial Data Output
<code>_CTPLS</code>	CTMU Output Pulse
<code>_C1TX</code>	ECAN1 Transmit
<code>_OC1</code>	Output Compare 1
<code>_OC2</code>	Output Compare 2
<code>_OC3</code>	Output Compare 3
<code>_OC4</code>	Output Compare 4
<code>_OC5</code>	Output Compare 5
<code>_OC6</code>	Output Compare 6
<code>_OC7</code>	Output Compare 7
<code>_OC8</code>	Output Compare 8

<code>_OC9</code>	Output Compare 9
<code>_OCFA</code>	Output Compare Fault A
<code>_OCFB</code>	Output Compare Fault B
<code>_PWM4H</code>	RPn tied to PWM output pins associated with PWM Generator 4
<code>_PWM4L</code>	RPn tied to PWM output pins associated with PWM Generator 4
<code>_REFCLKO</code>	REFCLK output signal
<code>_SCK1OUT</code>	SPI1 Clock Output
<code>_SCK2OUT</code>	SPI2 Clock Output
<code>_SCK3OUT</code>	SPI3 Clock Output
<code>_SDO1</code>	SPI1 Data Output
<code>_SDO2</code>	SPI2 Data Output
<code>_SDO3</code>	SPI3 Data Output
<code>_SS1OUT</code>	SPI1 Slave Select Output
<code>_SS2OUT</code>	SPI2 Slave Select Output
<code>_SS3OUT</code>	SPI3 Slave Select Output
<code>_SYNCI1</code>	External Synchronization signal to PWM Master Time Base
<code>_SYNCI2</code>	External Synchronization signal to PWM Master Time Base
<code>_SYNCO1</code>	RPn tied to external device synchronization signal via PWM master time base
<code>_U1RTS</code>	UART1 Request To Send
<code>_U2RTS</code>	UART2 Request To Send
<code>_U3RTS</code>	UART3 Request To Send
<code>_U4RTS</code>	UART4 Request To Send
<code>_U1TX</code>	UART1 Transmit
<code>_U2TX</code>	UART2 Transmit
<code>_U3TX</code>	UART3 Transmit
<code>_U4TX</code>	UART4 Transmit
<code>_UPDN</code>	QE1 direction (UPDN) status
<code>_UPDN1</code>	QE11 direction (UPDN) status
<code>_UPDN2</code>	QE12 direction (UPDN) status

Port Expander Library

The mikroC PRO for dsPIC30/33 and PIC24 provides a library for communication with the Microchip's Port Expander MCP23S17 via SPI interface. Connections of the dsPIC30/33 and PIC24 MCU and MCP23S17 is given on the schematic at the bottom of this page.

Important :

- The library uses the SPI module for communication. User must initialize the appropriate SPI module before using the Port Expander Library.
- For MCUs with multiple SPI modules it is possible to initialize all of them and then switch by using the `SPI_Set_Active()` function. See the SPI Library functions.
- Library does not use Port Expander interrupts.

Library Dependency Tree



External dependencies of Port Expander Library

The following variables must be defined in all projects using Port Expander Library:	Description :	Example :
<code>extern sfr sbit SPExpanderRST;</code>	Reset line.	<code>sbit SPExpanderRST at RF0_bit;</code>
<code>extern sfr sbit SPExpanderCS;</code>	Chip Select line.	<code>sbit SPExpanderCS at RF1_bit;</code>
<code>extern sfr sbit SPExpanderRST_Direction;</code>	Direction of the Reset pin.	<code>sbit SPExpanderRST_Direction at TRISF0_bit;</code>
<code>extern sfr sbit SPExpanderCS_Direction;</code>	Direction of the Chip Select pin.	<code>sbit SPExpanderCS_Direction at TRISF1_bit;</code>

Library Routines

- Expander_Init
- Expander_Init_Advanced
- Expander_Read_Byte
- Expander_Write_Byte
- Expander_Read_PortA
- Expander_Read_PortB
- Expander_Read_PortAB
- Expander_Write_PortA
- Expander_Write_PortB
- Expander_Write_PortAB
- Expander_Set_DirectionPortA
- Expander_Set_DirectionPortB
- Expander_Set_DirectionPortAB
- Expander_Set_PullUpsPortA
- Expander_Set_PullUpsPortB
- Expander_Set_PullUpsPortAB

Expander_Init

Prototype	<code>void Expander_Init(char ModuleAddress);</code>
Description	<p>Initializes Port Expander using SPI communication.</p> <p>Port Expander module settings :</p> <ul style="list-style-type: none"> - hardware addressing enabled - automatic address pointer incrementing disabled (byte mode) - BANK_0 register addressing - slew rate enabled
Parameters	- <code>ModuleAddress</code> : Port Expander hardware address, see schematic at the bottom of this page
Returns	Nothing.
Requires	<p>Global variables :</p> <ul style="list-style-type: none"> - <code>SPExpanderCS</code>: Chip Select line - <code>SPExpanderRST</code>: Reset line - <code>SPExpanderCS_Direction</code>: Direction of the Chip Select pin - <code>SPExpanderRST_Direction</code>: Direction of the Reset pin <p>must be defined before using this function.</p> <p>SPI module needs to be initialized. See <code>SPIx_Init</code> and <code>SPIx_Init_Advanced</code> routines.</p>
Example	<pre>// Port Expander module connections sbit SPExpanderRST at Rf0_bit; sbit SPExpanderCS at Rf1_bit; sbit SPExpanderRST_Direction at TRISF0_bit; sbit SPExpanderCS_Direction at TRISF1_bit; // End Port Expander module connections ... // If Port Expander Library uses SPI module SPI1_Init(); // Initialize SPI module used with PortExpander Expander_Init(0); // Initialize Port Expander</pre>
Notes	None.

Expander_Init_Advanced

Prototype	<code>void Expander_Init_Advanced(char *rstPort, char rstPin, char haen);</code>
Description	Initializes Port Expander using SPI communication.
Parameters	<ul style="list-style-type: none"> - <code>rstPort</code>: Port Expander's reset port - <code>rstPin</code>: Port Expander's reset pin - <code>haen</code>: Port Expander's hardware address
Returns	Nothing.
Requires	<ul style="list-style-type: none"> - <code>SPExpanderCS</code>: Chip Select line - <code>SPExpanderRST</code>: Reset line - <code>SPExpanderCS_Direction</code>: Direction of the Chip Select pin - <code>SPExpanderRST_Direction</code>: Direction of the Reset pin <p>must be defined before using this function.</p> <p>SPI module needs to be initialized. See <code>SPIx_Init</code> and <code>SPIx_Init_Advanced</code> routines.</p>
Example	<pre>// Port Expander module connections sbit SPExpanderRST at RF0_bit; sbit SPExpanderCS at RF1_bit; sbit SPExpanderRST_Direction at TRISF0_bit; sbit SPExpanderCS_Direction at TRISF1_bit; // End Port Expander module connections ... // If Port Expander Library uses SPI module SPI1_Init(); // Initialize SPI1 module used with PortExpander Expander_Init_Advanced(&PORTB, 0, 0); // Initialize Port Expander</pre>
Notes	None.

Expander_Read_Byte

Prototype	<code>char Expander_Read_Byte(char ModuleAddress, char RegAddress);</code>
Description	The function reads byte from Port Expander.
Parameters	- <code>ModuleAddress</code> : Port Expander hardware address, see schematic at the bottom of this page - <code>RegAddress</code> : Port Expander's internal register address
Returns	Byte read.
Requires	Port Expander must be initialized. See <code>Expander_Init</code> .
Example	<pre>// Read a byte from Port Expander's register char read_data; ... read_data = Expander_Read_Byte(0,1);</pre>
Notes	None.

Expander_Write_Byte

Prototype	<code>void Expander_Write_Byte(char ModuleAddress, char RegAddress, char data_);</code>
Description	Routine writes a byte to Port Expander.
Parameters	- <code>ModuleAddress</code> : Port Expander hardware address, see schematic at the bottom of this page - <code>RegAddress</code> : Port Expander's internal register address - <code>Data</code> : data to be written
Returns	Byte read.
Requires	Port Expander must be initialized. See <code>Expander_Init</code> .
Example	<pre>// Write a byte to the Port Expander's register Expander_Write_Byte(0,1,0xFF);</pre>
Notes	None.

Expander_Read_PortA

Prototype	<code>char Expander_Read_PortA(char ModuleAddress);</code>
Description	The function reads byte from Port Expander's PortA.
Parameters	- <code>ModuleAddress</code> : Port Expander hardware address, see schematic at the bottom of this page
Returns	Byte read.
Requires	Port Expander must be initialized. See <code>Expander_Init</code> . Port Expander's PortA should be configured as input. See <code>Expander_Set_DirectionPortA</code> and <code>Expander_Set_DirectionPortAB</code> routines.
Example	<pre>// Read a byte from Port Expander's PORTA char read_data; ... Expander_Set_DirectionPortA(0,0xFF); // set expander's porta to be input ... read_data = Expander_Read_PortA(0);</pre>
Notes	None.

Expander_Read_PortB

Prototype	<code>char Expander_Read_PortB(char ModuleAddress);</code>
Description	The function reads byte from Port Expander's PortB.
Parameters	- <code>ModuleAddress</code> : Port Expander hardware address, see schematic at the bottom of this page
Returns	Byte read.
Requires	Port Expander must be initialized. See <code>Expander_Init</code> . Port Expander's PortB should be configured as input. See <code>Expander_Set_DirectionPortB</code> and <code>Expander_Set_DirectionPortAB</code> routines.
Example	<pre>// Read a byte from Port Expander's PORTB char read_data; ... Expander_Set_DirectionPortB(0,0xFF); // set expander's portb to be input ... read_data = Expander_Read_PortB(0);</pre>
Notes	None.

Expander_Read_PortAB

Prototype	<code>unsigned int Expander_Read_PortAB(char ModuleAddress);</code>
Description	The function reads word from Port Expander's ports. PortA readings are in the higher byte of the result. PortB readings are in the lower byte of the result.
Parameters	- <code>ModuleAddress</code> : Port Expander hardware address, see schematic at the bottom of this page
Returns	Word read.
Requires	Port Expander must be initialized. See <code>Expander_Init</code> . Port Expander's PortA and PortB should be configured as inputs. See <code>Expander_Set_DirectionPortA</code> , <code>Expander_Set_DirectionPortB</code> and <code>Expander_Set_DirectionPortAB</code> routines.
Example	<pre>// Read a byte from Port Expander's PORTA and PORTB unsigned int read_data; ... Expander_Set_DirectionPortAB(0,0xFFFF); // set expander's porta and portb to be input ... read_data = Expander_Read_PortAB(0);</pre>
Notes	None.

Expander_Write_PortA

Prototype	<code>void Expander_Write_PortA(char ModuleAddress, char Data_);</code>
Description	The function writes byte to Port Expander's PortA.
Parameters	- <code>ModuleAddress</code> : Port Expander hardware address, see schematic at the bottom of this page - <code>Data</code> : data to be written
Returns	Nothing.
Requires	Port Expander must be initialized. See <code>Expander_Init</code> . Port Expander's PortA should be configured as output. See <code>Expander_Set_DirectionPortA</code> and <code>Expander_Set_DirectionPortAB</code> routines.
Example	<pre>// Write a byte to Port Expander's PORTA ... Expander_Set_DirectionPortA(0,0x00); // set expander's porta to be output ... Expander_Write_PortA(0, 0xAA);</pre>
Notes	None.

Expander_Write_PortB

Prototype	<code>void Expander_Write_PortB(char ModuleAddress, char Data_);</code>
Description	The function writes byte to Port Expander's PortB.
Parameters	- <code>ModuleAddress</code> : Port Expander hardware address, see schematic at the bottom of this page - <code>Data</code> : data to be written
Returns	Nothing.
Requires	Port Expander must be initialized. See <code>Expander_Init</code> . Port Expander's PortB should be configured as output. See <code>Expander_Set_DirectionPortB</code> and <code>Expander_Set_DirectionPortAB</code> routines.
Example	<pre>// Write a byte to Port Expander's PORTB ... Expander_Set_DirectionPortB(0,0x00); // set expander's portb to be output ... Expander_Write_PortB(0, 0x55);</pre>
Notes	None.

Expander_Write_PortAB

Prototype	<code>void Expander_Write_PortAB(char ModuleAddress, unsigned int Data_);</code>
Description	The function writes word to Port Expander's ports.
Parameters	- <code>ModuleAddress</code> : Port Expander hardware address, see schematic at the bottom of this page - <code>Data</code> : data to be written. Data to be written to PortA are passed in <code>Data</code> 's higher byte. Data to be written to PortB are passed in <code>Data</code> 's lower byte
Returns	Nothing.
Requires	Port Expander must be initialized. See <code>Expander_Init</code> . Port Expander's PortA and PortB should be configured as outputs. See <code>Expander_Set_DirectionPortA</code> , <code>Expander_Set_DirectionPortB</code> and <code>Expander_Set_DirectionPortAB</code> routines.
Example	<pre>// Write a byte to Port Expander's PORTA and PORTB ... Expander_Set_DirectionPortAB(0,0x0000); // set expander's porta and portb to be output ... Expander_Write_PortAB(0, 0xAA55);</pre>
Notes	None.

Expander_Set_DirectionPortA

Prototype	<code>void Expander_Set_DirectionPortA(char ModuleAddress, char Data_);</code>
Description	The function sets Port Expander's PortA direction.
Parameters	- <code>ModuleAddress</code> : Port Expander hardware address, see schematic at the bottom of this page - <code>Data</code> : data to be written to the PortA direction register. Each bit corresponds to the appropriate pin of the PortA register. Set bit designates corresponding pin as input. Cleared bit designates corresponding pin as output.
Returns	Nothing.
Requires	Port Expander must be initialized. See <code>Expander_Init</code> .
Example	<pre>// Set Port Expander's PORTA to be output Expander_Set_DirectionPortA(0,0x00);</pre>
Notes	None.

Expander_Set_DirectionPortB

Prototype	<code>void Expander_Set_DirectionPortB(char ModuleAddress, char Data_);</code>
Description	The function sets Port Expander's PortB direction.
Parameters	- ModuleAddress : Port Expander hardware address, see schematic at the bottom of this page - Data : data to be written to the PortB direction register. Each bit corresponds to the appropriate pin of the PortB register. Set bit designates corresponding pin as input. Cleared bit designates corresponding pin as output.
Returns	Nothing.
Requires	Port Expander must be initialized. See Expander_Init.
Example	<pre>// Set Port Expander's PORTB to be input Expander_Set_DirectionPortB(0,0xFF);</pre>
Notes	None.

Expander_Set_DirectionPortAB

Prototype	<code>void Expander_Set_DirectionPortAB(char ModuleAddress, unsigned int Direction);</code>
Description	The function sets Port Expander's PortA and PortB direction.
Parameters	- ModuleAddress : Port Expander hardware address, see schematic at the bottom of this page - Direction : data to be written to direction registers. Data to be written to the PortA direction register are passed in Direction's higher byte. Data to be written to the PortB direction register are passed in Direction's lower byte. Each bit corresponds to the appropriate pin of the PortA/PortB register. Set bit designates corresponding pin as input. Cleared bit designates corresponding pin as output.
Returns	Nothing.
Requires	Port Expander must be initialized. See Expander_Init.
Example	<pre>// Set Port Expander's PORTA to be output and PORTB to be input Expander_Set_DirectionPortAB(0,0x00FF);</pre>
Notes	None.

Expander_Set_PullUpsPortA

Prototype	<code>void Expander_Set_PullUpsPortA(char ModuleAddress, char Data_);</code>
Description	The function sets Port Expander's PortA pull up/down resistors.
Parameters	- ModuleAddress : Port Expander hardware address, see schematic at the bottom of this page - Data : data for choosing pull up/down resistors configuration. Each bit corresponds to the appropriate pin of the PortA register. Set bit enables pull-up for corresponding pin.
Returns	Nothing.
Requires	Port Expander must be initialized. See Expander_Init.
Example	<pre>// Set Port Expander's PORTA pull-up resistors Expander_Set_PullUpsPortA(0, 0xFF);</pre>
Notes	None.

Expander_Set_PullUpsPortB

Prototype	<code>void Expander_Set_PullUpsPortB(char ModuleAddress, char Data_);</code>
Description	The function sets Port Expander's PortB pull up/down resistors.
Parameters	- <code>ModuleAddress</code> : Port Expander hardware address, see schematic at the bottom of this page - <code>Data</code> : data for choosing pull up/down resistors configuration. Each bit corresponds to the appropriate pin of the PortB register. Set bit enables pull-up for corresponding pin.
Returns	Nothing.
Requires	Port Expander must be initialized. See <code>Expander_Init</code> .
Example	<pre>// Set Port Expander's PORTB pull-up resistors Expander_Set_PullUpsPortB(0, 0xFF);</pre>
Notes	None.

Expander_Set_PullUpsPortAB

Prototype	<code>void Expander_Set_PullUpsPortAB(char ModuleAddress, unsigned int PullUps);</code>
Description	The function sets Port Expander's PortA and PortB pull up/down resistors.
Parameters	- <code>ModuleAddress</code> : Port Expander hardware address, see schematic at the bottom of this page - <code>PullUps</code> : data for choosing pull up/down resistors configuration. PortA pull up/down resistors configuration is passed in <code>PullUps</code> 's higher byte. PortB pull up/down resistors configuration is passed in <code>PullUps</code> 's lower byte. Each bit corresponds to the appropriate pin of the PortA/PortB register. Set bit enables pull-up for corresponding pin.
Returns	Nothing.
Requires	Port Expander must be initialized. See <code>Expander_Init</code> .
Example	<pre>// Set Port Expander's PORTA and PORTB pull-up resistors Expander_Set_PullUpsPortAB(0, 0xFFFF);</pre>
Notes	None.

Library Example

The example demonstrates how to communicate with Port Expander MCP23S17. Note that Port Expander pins A2 A1 A0 are connected to GND so Port Expander Hardware Address is 0.

Copy Code To Clipboard

```
// Port Expander module connections
sbit SPExpanderRST at RF0_bit;
sbit SPExpanderCS at RF1_bit;
sbit SPExpanderRST_Direction at TRISF0_bit;
sbit SPExpanderCS_Direction at TRISF1_bit;
// End Port Expander module connections

unsigned int i = 0;

void main() {
    ADPCFG = 0xFFFF;           // initialize AN pins as digital
    TRISB = 0x00;
    LATB = 0xFF;

    // If Port Expander Library uses SPI1 module
    SPI1_Init();               // Initialize SPI module used with
    PortExpander

    Expander_Init(0);          // Initialize Port Expander

    Expander_Set_DirectionPortA(0, 0x00); // Set Expander's PORTA to be output

    Expander_Set_DirectionPortB(0,0xFF); // Set Expander's PORTB to be input
    Expander_Set_PullUpsPortB(0,0xFF); // Set pull-ups to all of the Expander's PORTB
    pins

    while(1) {                 // Endless loop
        Expander_Write_PortA(0, i++); // Write i to expander's PORTA
        PORTB = Expander_Read_PortB(0); // Read expander's PORTB and write it to LEDs
        Delay_ms(100);
    }
}
```

HW Connection

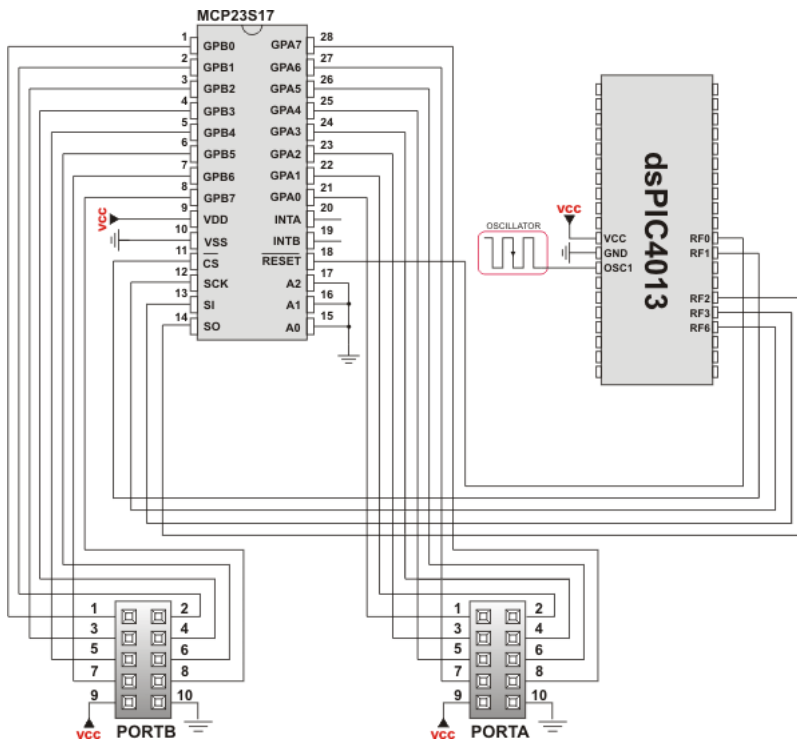

Port Expander HW connection

PS/2 Library

The mikroC PRO for dsPIC30/33 and PIC24 provides a library for communication with the common PS/2 keyboard.

Important :

- The library does not utilize interrupts for data retrieval, and requires the oscillator clock to be at least 6MHz.
- The pins to which a PS/2 keyboard is attached should be connected to the pull-up resistors.
- Although PS/2 is a two-way communication bus, this library does not provide MCU-to-keyboard communication; e.g. pressing the Caps Lock key will not turn on the Caps Lock LED.

External dependencies of PS/2 Library

The following variables must be defined in all projects using PS/2 Library:	Description :	Example :
<code>extern sfr sbit PS2_Data;</code>	PS/2 Data line.	<code>sbit PS2_Data at RB0_bit;</code>
<code>extern sfr sbit PS2_Clock;</code>	PS/2 Clock line.	<code>sbit PS2_Clock at RB1_bit;</code>
<code>extern sfr sbit PS2_Data_Direction;</code>	Direction of the PS/2 Data pin.	<code>sbit PS2_Data_Direction at TRISB0_bit;</code>
<code>extern sfr sbit PS2_Clock_Direction;</code>	Direction of the PS/2 Clock pin.	<code>sbit PS2_Clock_Direction at TRISB1_bit;</code>

Library Routines

- Ps2_Config
- Ps2_Key_Read

Ps2_Config

Prototype	<code>void Ps2_Config();</code>
Description	Initializes the MCU for work with the PS/2 keyboard.
Parameters	None.
Returns	Nothing.
Requires	Global variables : <ul style="list-style-type: none"> - <code>PS2_Data</code>: Data signal line - <code>PS2_Clock</code>: Clock signal line - <code>PS2_Data_Direction</code>: Direction of the Data pin - <code>PS2_Clock_Direction</code>: Direction of the Clock pin <p>must be defined before using this function.</p>
Example	<pre>// PS2 pinout definition sbit PS2_Data at RB0_bit; sbit PS2_Clock at RB1_bit; sbit PS2_Data_Direction at TRISB0_bit; sbit PS2_Clock_Direction at TRISB1_bit; // End of PS2 pinout definition ... Ps2_Config(); // Init PS/2 Keyboard</pre>
Notes	None.

Ps2_Key_Read

Prototype	<code>unsigned int Ps2_Key_Read(unsigned short *value, unsigned short *special, unsigned short *pressed);</code>
Description	The function retrieves information on key pressed.
Parameters	<ul style="list-style-type: none"> - <code>value</code>: holds the value of the key pressed. For characters, numerals, punctuation marks, and space <code>value</code> will store the appropriate ASCII code. Routine “recognizes” the function of Shift and Caps Lock, and behaves appropriately. For special function keys see Special Function Keys Table. - <code>special</code>: is a flag for special function keys (F1, Enter, Esc, etc). If key pressed is one of these, <code>special</code> will be set to 1, otherwise 0. - <code>pressed</code>: is set to 1 if the key is pressed, and 0 if it is released.
Returns	<ul style="list-style-type: none"> - 1 if reading of a key from the keyboard was successful - 0 if no key was pressed
Requires	PS/2 keyboard needs to be initialized. See <code>Ps2_Config</code> routine.
Example	<pre>unsigned short keydata = 0, special = 0, down = 0; ... // Press Enter to continue: do { if (Ps2_Key_Read(&keydata, &special, &down)) { if (down && (keydata == 16)) break; } } while (1);</pre>
Notes	None.

Special Function Keys

Key	Value returned
F1	1
F2	2
F3	3
F4	4
F5	5
F6	6
F7	7
F8	8
F9	9
F10	10
F11	11
F12	12
Enter	13
Page Up	14
Page Down	15
Backspace	16
Insert	17
Delete	18
Windows	19
Ctrl	20
Shift	21
Alt	22
Print Screen	23
Pause	24
Caps Lock	25
End	26
Home	27
Scroll Lock	28
Num Lock	29
Left Arrow	30
Right Arrow	31
Up Arrow	32
Down Arrow	33
Escape	34
Tab	35

Library Example

This simple example reads values of the pressed keys on the PS/2 keyboard and sends them via UART.

Copy Code To Clipboard

```
sbit PS2_Data          at RB0_bit;
sbit PS2_Clock        at RB1_bit;
sbit PS2_Data_Direction at TRISB0_bit;
sbit PS2_Clock_Direction at TRISB1_bit;

unsigned short keydata = 0, special = 0, down = 0;

void main() {

    ADPCFG = 0xFFFF;                                // Configure AN pins as digital I/O

    UART1_Init(19200);                               // Initialize UART module at 19200 bps
    Ps2_Config();                                   // Init PS/2 Keyboard
    Delay_ms(100);                                  // Wait for keyboard to finish
    UART1_Write_Text("Ready");
    UART1_Write(10);                                // Line Feed
    UART1_Write(13);                                // Carriage return

    do {
        if (Ps2_Key_Read(&keydata, &special, &down)) {
            if (down && (keydata == 16)) {          // Backspace
                UART1_Write(0x08);
            }
            else if (down && (keydata == 13)) {    // Enter
                UART1_Write('r');                 // send carriage return to usart
terminal //Usart_Write('n');                       // uncomment this line if usart
terminal also expects line feed                    // for new line transition

            }
            else if (down && !special && keydata) {
                UART1_Write(keydata);
            }
        }
        Delay_ms(1);                                // debounce
    } while (1);
}
```

HW Connection

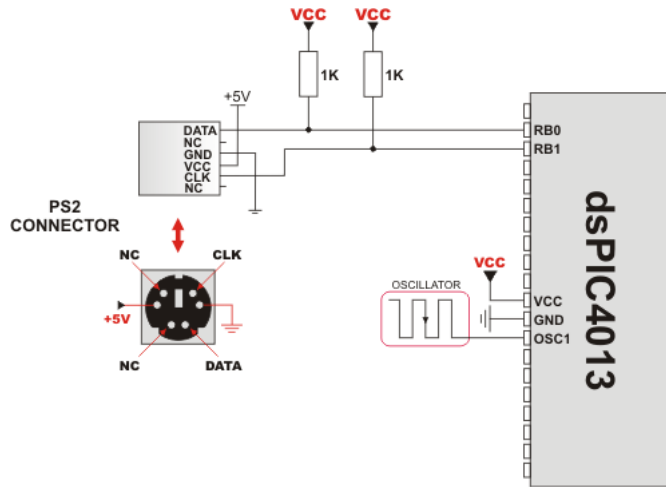

Example of PS2 keyboard connection

PWM Library

The CCP module is available with a number of dsPIC30/33 and PIC24 MCUs. mikroC PRO for dsPIC30/33 and PIC24 provides a library which simplifies using of the PWM HW Module.

Important : PWM module uses either Timer2 or Timer3 module.

Library Routines

- PWM_Init
- PWM_Set_Duty
- PWM_Start
- PWM_Stop

PWM_Init

Prototype	<pre> unsigned int PWM_Init(unsigned long freq_hz, unsigned int enable_channel_x, unsigned int timer_prescale, unsigned int use_timer_x); // 30F1010 and dsPIC33FJ06GS101/102/202 prototype unsigned int PWM_Init(unsigned long freq_hz, unsigned int enable_channel_x, unsigned int timer_prescale); </pre>
Description	Initializes the PWM module with duty ratio 0.
Parameters	<ul style="list-style-type: none"> - <code>freq_hz</code>: PWM frequency in Hz (refer to device datasheet for correct values in respect with F_{osc}) - <code>enable_channel_x</code>: number of PWM channel to be initialized. Refer to MCU's datasheet for available PWM channels - <code>timer_prescale</code>: timer prescaler parameter. Valid values: 1, 8, 64, and 256 - <code>use_timer_x</code>: timer to be used with the PWM module. Valid values: 2 (Timer2) and 3 (Timer3)
Returns	<ul style="list-style-type: none"> - 0xFFFF - if timer settings are not valid - otherwise returns calculated timer period
Requires	MCU must have the HW PWM Module.
Example	<pre> // Initializes the PWM module at 5KHz, channel 1, no clock prescale, timer2 : unsigned int pwm_period1; ... pwm_period1 = PWM_Init(5000, 1, 0, 2); </pre>
Notes	Number of available PWM channels depends on MCU. Refer to MCU datasheet for details.

PWM_Set_Duty

Prototype	<pre> void PWM_Set_Duty(unsigned duty, unsigned channel); </pre>
Description	The function changes PWM duty ratio.
Parameters	<ul style="list-style-type: none"> - <code>duty</code>: PWM duty ratio. Valid values: 0 to timer period returned by the PWM_Init function. - <code>channel</code>: number of PWM channel to change duty to.
Returns	Nothing.
Requires	<p>MCU must have the HW PWM Module.</p> <p>PWM channel must be properly initialized. See PWM_Init routine.</p>
Example	<pre> // Set channel 1 duty ratio to 50%: unsigned int pwm_period1; ... PWM_Set_Duty(pwm_period1/2, 1); </pre>
Notes	Number of available PWM channels depends on MCU. Refer to MCU datasheet for details.

PWM_Start

Prototype	<code>void PWM_Start(char enable_channel_x);</code>
Description	Starts PWM at requested channel.
Parameters	- <code>enable_channel_x</code> : number of PWM channel
Returns	Nothing.
Requires	MCU must have the HW PWM Module. PWM channel must be properly configured. See the <code>PWM_Init</code> and <code>PWM_Set_Duty</code> routines.
Example	<pre>// start PWM at channel 1 PWM_Start(1);</pre>
Notes	Number of available PWM channels depends on MCU. Refer to MCU datasheet for details.

PWM_Stop

Prototype	<code>void PWM_Stop(char disable_channel_x);</code>
Description	Stops PWM at requested channel.
Parameters	- <code>disable_channel_x</code> : number of PWM channel
Returns	Nothing.
Requires	MCU must have the HW PWM Module.
Example	<pre>// stop PWM at channel 1 PWM_Stop(1);</pre>
Notes	Number of available PWM channels depends on MCU. Refer to MCU datasheet for details.

Library Example

The example changes PWM duty ratio on channels 1 and 2 continuously. If LEDs are connected to channels 1 and 2, a gradual change of emitted light will be noticeable.

Copy Code To Clipboard

```
unsigned int current_duty, old_duty, current_duty1, old_duty1;
unsigned int pwm_period1, pwm_period2;

void InitMain() {
    ADPCFG = 0xFFFF;           // Configure AN pins as digital I/O
    TRISB = 0xFFFF;           // configure PORTB pins as input
    PORTD = 0;                 // set PORTD to 0
    TRISD = 0;                 // designate PORTD pins as output
}

void main() {
    InitMain();
    current_duty = 16;         // initial value for current_duty
    current_duty1 = 16;        // initial value for current_duty1
```

```
pwm_period1 = PWM_Init(5000 , 1, 1, 2);
pwm_period2 = PWM_Init(10000, 2, 1, 3);

PWM_Start(1);
PWM_Start(2);

PWM_Set_Duty(current_duty, 1);           // Set current duty for PWM1
PWM_Set_Duty(current_duty1, 2);         // Set current duty for PWM2

while (1) {                               // endless loop
    if (RB0_bit) {                          // button on RB0 pressed
        Delay_ms(20);
        current_duty++;                     // increment current_duty
        if (current_duty > pwm_period1) { // if we increase current_duty greater then
possible pwm_period1 value
            current_duty = 0;               // reset current_duty value to zero
        }
        PWM_Set_Duty(current_duty, 1);     // set newly acquired duty ratio
    }

    if (RB1_bit) {                          // button on RB1 pressed
        Delay_ms(20);
        current_duty--;                     // decrement current_duty
        if (current_duty > pwm_period1) { // if we decrease current_duty greater then
possible pwm_period1 value (overflow)
            current_duty = pwm_period1;    // set current_duty to max possible value
        }
        PWM_Set_Duty(current_duty, 1);     // set newly acquired duty ratio
    }

    if (RB2_bit) {                          // button on RB2 pressed
        Delay_ms(20);
        current_duty1++;                    // increment current_duty1
        if (current_duty1 > pwm_period2) { // if we increase current_duty1 greater
then possible pwm_period2 value
            current_duty1 = 0;             // reset current_duty1 value to zero
        }
        PWM_Set_Duty(current_duty1, 2);    // set newly acquired duty ratio
    }

    if (RB3_bit) {                          // button on RB3 pressed
        Delay_ms(20);
        current_duty1--;                    // decrement current_duty1
        if (current_duty1 > pwm_period2) { // if we decrease current_duty1 greater then
possible pwm_period1 value (overflow)
            current_duty1 = pwm_period2;  // set current_duty to max possible value
        }
        PWM_Set_Duty(current_duty1, 2);    // set newly acquired duty ratio
    }

    Delay_ms(5);                            // slow down change pace a little
}
}
```

HW Connection

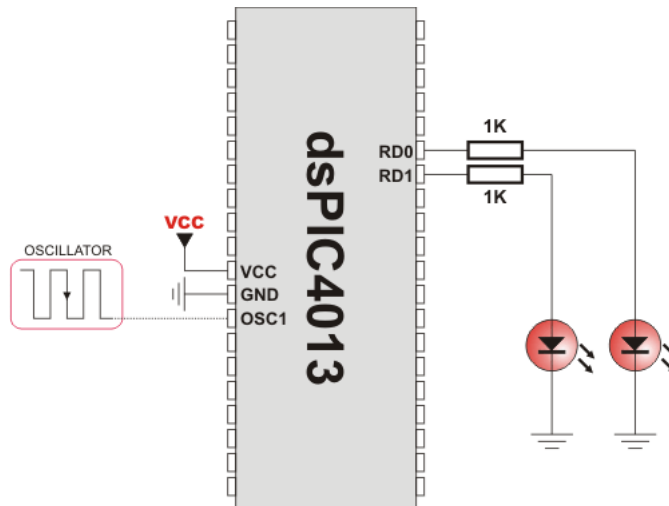

PWM demonstration

PWM Motor Control Library

The PWM Motor Control module is available with a number of dsPIC30/33 MCUs. The mikroC PRO for dsPIC30/33 and PIC24 provides a library which simplifies using the PWM Motor Control module.

Important :

- Number of PWM modules per MCU differs from chip to chip. Please, read the appropriate datasheet before utilizing this library.
- PWM library routines require you to specify the module you want to use. To use the desired PWM module, simply change the letter **x** in the routine prototype for a number from **1** to **2**.

Library Routines

- PWMx_Mc_Init
- PWMx_Mc_Set_Duty
- PWMx_Mc_Start
- PWMx_Mc_Stop

PWMx_Mc_Init

Prototype	<code>unsigned int PWMx_Mc_Init(unsigned int freq_hz, unsigned int pair_output_mode, unsigned int enable_output_x, unsigned int clock_prescale_output_postscale);</code>
Description	Initializes the Motor Control PWM module with duty ratio 0. The function calculates timer period, writes it to the MCU's PTPER register and returns it as the function result.
Parameters	<ul style="list-style-type: none"> - <code>freq_hz</code>: PWM frequency in Hz (refer to device datasheet for correct values in respect with F_{osc}) - <code>pair_output_mode</code>: output mode for output pin pairs: 1 = independent, 0 = complementary. If <code>pair_output_mode.B0</code> is equal to 1 then PWM channels PWM1L and PWM1H will be independent, If <code>pair_output_mode.B1</code> is equal to 0 then PWM channels PWM2L and PWM2H will be complementary, ... If <code>pair_output_mode.Bn</code> is equal to 1 then PWM channels PWM(n+1)L and PWM(n+1)H will be independent, If <code>pair_output_mode.Bn</code> is equal to 0 then PWM channels PWM(n+1)L and PWM(n+1)H will be complementary. - <code>enable_output_x</code>: bits <7..0> are enabling corresponding PWM channels <PWM4H, PWM3H, PWM2H, PWM1H, PWM4L, PWM3L, PWM2L, PWM1L>. If bit value is equal to 0 then corresponding PWM channel is disabled (pin is standard I/O). If bit value is equal to 1 then corresponding PWM channel is enabled (pin is PWM output). For detailed explanation consult the "Motor Control PWM Module" section in device datasheet - <code>clock_prescale_output_postscale</code>: PWM clock prescaler/postscaler settings. Values <0..3> and <0..15> correspond to prescaler/postscaler <1:1, 1:4, 1:16, 1:64> and <1:1, 1:2, ..., 1:16>
Returns	Calculated timer period.
Requires	The dsPIC30/33 MCU must have the Motor Control PWM module.
Example	<pre>// Initializes the PWM1 module at 5KHz, complementary pin-pair output, output enabled on pins 41..11, no clock prescale and no clock postscale: unsigned int duty_50; ... duty_50 = PWM1_Mc_Init(5000, 1, 0x0F, 0);</pre>
Notes	<ul style="list-style-type: none"> - Number of PWM modules per MCU differs from chip to chip. Please, read the appropriate datasheet before utilizing this library. - PWM library routines require you to specify the module you want to use. To use the desired PWM module, simply change the letter x in the routine prototype for a number from 1 to 2.

PWMx_Mc_Set_Duty

Prototype	<pre>void PWM1_Mc_Set_Duty(unsigned duty, unsigned channel); // For dsPIC 33FJ MCUs that have PWM2 module : void PWM2_Mc_Set_Duty(unsigned duty);</pre>
Description	The function changes PWM duty ratio.
Parameters	<ul style="list-style-type: none"> - duty: PWM duty ratio. Valid values: 0 to timer period returned by the PWMx_Mc_Init function. - channel: number of PWM channel to change duty to.
Returns	Nothing.
Requires	<p>The dsPIC30/33 MCU must have the Motor Control PWM module.</p> <p>The PWM module needs to be initialized. See the PWMx_Mc_Init function.</p>
Example	<pre>// Set duty ratio to 50% at channel 1: PWM1_Mc_Init(5000,1,0xF,0); ... PWM1_Mc_Set_Duty(32767, 1);</pre>
Notes	<ul style="list-style-type: none"> - Number of PWM modules per MCU differs from chip to chip. Please, read the appropriate datasheet before utilizing this library. - PWM library routines require you to specify the module you want to use. To use the desired PWM module, simply change the letter x in the routine prototype for a number from 1 to 2.

PWMx_Mc_Start

Prototype	<pre>void PWMx_Mc_Start();</pre>
Description	Starts the Motor Control PWM module (channels initialized in the PWMx_Mc_Init function).
Parameters	None.
Returns	Nothing.
Requires	<p>The dsPIC30/33 MCU must have the Motor Control PWM module.</p> <p>The PWM module needs to be initialized. See the PWMx_Mc_Init function.</p>
Example	<pre>// start the Motor Control PWM1 module PWM1_Mc_Start();</pre>
Notes	<ul style="list-style-type: none"> - Number of PWM modules per MCU differs from chip to chip. Please, read the appropriate datasheet before utilizing this library. - PWM library routines require you to specify the module you want to use. To use the desired PWM module, simply change the letter x in the routine prototype for a number from 1 to 2.

PWMx_Mc_Stop

Prototype	<code>void PWMx_Mc_Stop();</code>
Description	Stops the Motor Control PWM module.
Parameters	None.
Returns	Nothing.
Requires	The dsPIC30/33 MCU must have the Motor Control PWM module.
Example	<pre>// stop the Motor Control PWM1 module PWM1_Mc_Stop();</pre>
Notes	<ul style="list-style-type: none"> - Number of PWM modules per MCU differs from chip to chip. Please, read the appropriate datasheet before utilizing this library. - PWM library routines require you to specify the module you want to use. To use the desired PWM module, simply change the letter x in the routine prototype for a number from 1 to 2.

Library Example

The example changes PWM duty ratio on channel 1 continually. If LED is connected to the channel 1, a gradual change of emitted light will be noticeable.

Copy Code To Clipboard

```
unsigned int i;

unsigned int duty_50;

void main(){

    ADPCFG = 0xFFFF;           // initialize AN pins as digital
    PORTB  = 0xAAAA;
    TRISB  = 0;                 // initialize portb as output
    Delay_ms(1000);

    duty_50 = PWM1_MC_Init(5000, 0, 0x01, 0); // Pwm_Mc_Init returns 50% of the
duty
    PWM1_MC_Set_Duty(i = duty_50, 1);
    PWM1_MC_Start();

    do
    {
        i--;
        PWM1_MC_Set_Duty(i, 1);
        Delay_ms(10);
        if (i == 0)
            i = duty_50 * 2 - 1;           // Let us not allow the overflow
        PORTB = i;
    }
    while(1);
}
```

HW Connection

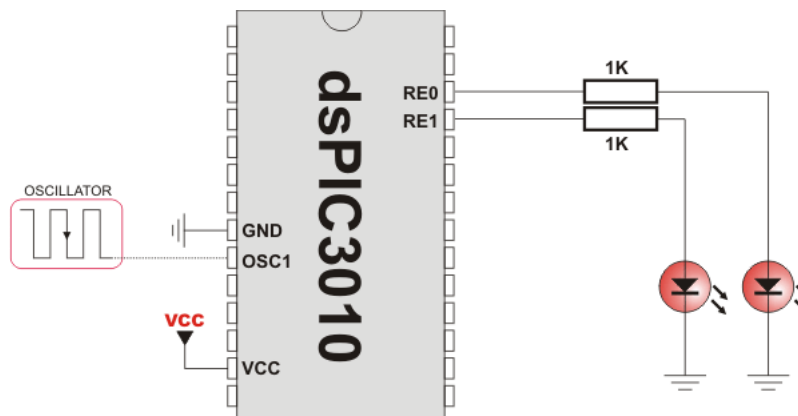

PWM Motor Control demonstration

RS-485 Library

RS-485 is a multipoint communication which allows multiple devices to be connected to a single bus. The mikroC PRO for dsPIC30/33 and PIC24 provides a set of library routines for comfortable work with RS485 system using Master/Slave architecture. Master and Slave devices interchange packets of information. Each of these packets contains synchronization bytes, CRC byte, address byte and the data. Each Slave has unique address and receives only packets addressed to it. The Slave can never initiate communication.

It is the user's responsibility to ensure that only one device transmits via 485 bus at a time.

The RS-485 routines require the UART module. Pins of UART need to be attached to RS-485 interface transceiver, such as LTC485 or similar (see schematic at the bottom of this page).

Library constants:

- START byte value = 150
- STOP byte value = 169
- Address 50 is the broadcast address for all Slaves (packets containing address 50 will be received by all Slaves except the Slaves with addresses 150 and 169).

Important :

- The library uses the UART module for communication. The user must initialize the appropriate UART module before using the RS-485 Library.
- For MCUs with multiple UART modules it is possible to initialize them and then switch by using the UART_Set_Active routine.

Library Dependency Tree

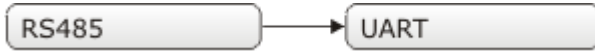

External dependencies of RS-485 Library

The following variable must be defined in all projects using RS-485 Library:	Description :	Example :
<code>extern sfr sbit RS485_rxtx_pin;</code>	Control RS-485 Transmit/Receive operation mode	<code>sbit RS485_rxtx_pin at RF2_bit;</code>
<code>extern sfr sbit RS485_rxtx_pin_direction;</code>	Direction of the RS-485 Transmit/Receive pin	<code>sbit RS485_rxtx_pin_direction at TRISF2_bit;</code>

Library Routines

- RS485Master_Init
- RS485Master_Receive
- RS485Master_Send
- RS485Slave_Init
- RS485Slave_Receive
- RS485Slave_Send

RS485Master_Init

Prototype	<code>void RS485Master_Init();</code>
Description	Initializes MCU as a Master for RS-485 communication.
Parameters	None.
Returns	Nothing.
Requires	Global variables : - <code>RS485_rxtx_pin</code> - this pin is connected to RE/DE input of RS-485 transceiver(see schematic at the bottom of this page). RE/DE signal controls RS-485 transceiver operation mode. - <code>RS485_rxtx_pin_direction</code> - direction of the RS-485 Transmit/Receive pin. must be defined before using this routine. UART HW module needs to be initialized. See <code>UARTx_Init</code> .
Example	<pre> // RS485 module pinout sbit RS485_rxtx_pin_direction at RF2_bit; // transmit/receive control set to PORTC.B2 sbit RS485_rxtx_pin_direction at TRISF2_bit; // RxTx pin direction set as output // end RS485 module pinout ... UART1_Init(9600); // initialize UART1 module RS485Master_Init(); // initialize MCU as a Master for RS-485 communication </pre>
Notes	None

RS485Master_Receive

Prototype	<code>void RS485Master_Receive(char *data_buffer);</code>
Description	Receives messages from Slaves. Messages are multi-byte, so this routine must be called for each byte received.
Parameters	<ul style="list-style-type: none"> - <code>data_buffer</code>: 7 byte buffer for storing received data. Data will be stored in the following manner: <ul style="list-style-type: none"> - <code>data_buffer[0..2]</code>: message content - <code>data_buffer[3]</code>: number of message bytes received, 1–3 - <code>data_buffer[4]</code>: is set to 255 when message is received - <code>data_buffer[5]</code>: is set to 255 if error has occurred - <code>data_buffer[6]</code>: address of the Slave which sent the message <p>The routine automatically adjusts <code>data[4]</code> and <code>data[5]</code> upon every received message. These flags need to be cleared by software.</p>
Returns	Nothing.
Requires	MCU must be initialized as a Master for RS-485 communication. See <code>RS485Master_Init</code> .
Example	<pre>char msg[8]; ... RS485Master_Receive(msg);</pre>
Notes	None

RS485Master_Send

Prototype	<code>void RS485Master_Send(char *data_buffer, char datalen, char slave_address);</code>
Description	Sends message to Slave(s). Message format can be found at the bottom of this page.
Parameters	<ul style="list-style-type: none"> - <code>data_buffer</code>: data to be sent - <code>datalen</code>: number of bytes for transmission. Valid values: 0...3. - <code>slave_address</code>: Slave(s) address
Returns	Nothing.
Requires	<p>MCU must be initialized as a Master for RS-485 communication. See <code>RS485Master_Init</code>.</p> <p>It is the user's responsibility to ensure (by protocol) that only one device sends data via 485 bus at a time.</p>
Example	<pre>char msg[8]; ... // send 3 bytes of data to Slave with address 0x12 RS485Master_Send(msg, 3, 0x12);</pre>
Notes	None

RS485Slave_Init

Prototype	<code>void RS485Slave_Init(char Slave_address);</code>
Description	Initializes MCU as a Slave for RS-485 communication.
Parameters	- <code>Slave_address</code> : Slave address
Returns	Nothing.
Requires	<p>Global variables :</p> <ul style="list-style-type: none"> - <code>RS485_rxtx_pin</code> - this pin is connected to RE/DE input of RS-485 transceiver(see schematic at the bottom of this page). RE/DE signal controls RS-485 transceiver operation mode. Valid values: 1 (for transmitting) and 0 (for receiving) - <code>RS485_rxtx_pin_direction</code> - direction of the RS-485 Transmit/Receive pin. <p>must be defined before using this routine.</p> <p>UART HW module needs to be initialized. See <code>UARTx_Init</code>.</p>
Example	<p>Initialize MCU as a Slave with address 160:</p> <pre>// RS485 module pinout sbit RS485_rxtx_pin at RC2_bit; // transmit/receive control set to PORTC.B2 sbit RS485_rxtx_pin_direction at TRISC2_bit; // RxTx pin direction set as output // End of RS485 module pinout ... UART1_Init(9600); // initialize UART1 module RS485Slave_Init(160); // intialize MCU as a Slave for RS-485 communication with address 160</pre>
Notes	None

RS485Slave_Receive

Prototype	<code>void RS485Slave_Receive(char *data_buffer);</code>
Description	Receives messages from Master. If Slave address and Message address field don't match then the message will be discarded. Messages are multi-byte, so this routine must be called for each byte received.
Parameters	<ul style="list-style-type: none"> - <code>data_buffer</code>: 6 byte buffer for storing received data, in the following manner: <ul style="list-style-type: none"> - <code>data_buffer[0..2]</code>: message content - <code>data_buffer[3]</code>: number of message bytes received, 1–3 - <code>data_buffer[4]</code>: is set to 255 when message is received - <code>data_buffer[5]</code>: is set to 255 if error has occurred <p>The routine automatically adjusts <code>data[4]</code> and <code>data[5]</code> upon every received message. These flags need to be cleared by software.</p>
Returns	Nothing.
Requires	MCU must be initialized as a Slave for RS-485 communication. See <code>RS485Slave_Init</code> .
Example	<pre>char msg[8]; ... RS485Slave_Read(msg);</pre>
Notes	None

RS485Slave_Send

Prototype	<code>void RS485Slave_Send(char *data_buffer, char datalen);</code>
Description	Sends message to Master. Message format can be found at the bottom of this page.
Parameters	<ul style="list-style-type: none"> - <code>data_buffer</code>: data to be sent - <code>datalen</code>: number of bytes for transmission. Valid values: 0...3.
Returns	Nothing.
Requires	MCU must be initialized as a Slave for RS-485 communication. See <code>RS485Slave_Init</code> . It is the user's responsibility to ensure (by protocol) that only one device sends data via 485 bus at a time.
Example	<pre>char msg[8]; ... // send 2 bytes of data to the Master RS485Slave_Send(msg, 2);</pre>
Notes	None

Library Example

This is a simple demonstration of RS485 Library routines usage.

Master sends message to Slave with address 160 and waits for a response. The Slave accepts data, increments it and sends it back to the Master. Master then does the same and sends incremented data back to Slave, etc.

Master displays received data on PORTB, while error on receive (0xAA) and number of consecutive unsuccessful retries are displayed on PORTD. Slave displays received data on PORTB, while error on receive (0xAA) is displayed on PORTD. Hardware configurations in this example are made for the EasydsPIC4A board and 30f4013.

RS485 Master code:

Copy Code To Clipboard

```
sbit rs485_rxtx_pin at RF2_bit;           // set transceive pin
sbit rs485_rxtx_pin_direction at TRISF2_bit; // set transceive pin direction

char dat[10];                             // buffer for receiving/sending messages
char i,j;

// Interrupt routine
void interrupt() org IVT_ADDR_U2RXINTERRUPT {
    RS485Master_Receive(dat);
    U2RXIF_bit = 0;                       // ensure interrupt not pending
}

void main(){
    long cnt = 0;

    ADPCFG = 0xFFFF;

    PORTB = 0;
    PORTD = 0;
    TRISB = 0;
    TRISD = 0;

    UART2_Init(9600);                     // initialize UART2 module
    Delay_ms(100);

    RS485Master_Init();                   // initialize MCU as Master

    dat[0] = 0xAA;
    dat[1] = 0xF0;
    dat[2] = 0x0F;
    dat[4] = 0;                           // ensure that message received flag is 0
    dat[5] = 0;                           // ensure that error flag is 0
    dat[6] = 0;

    RS485Master_Send(dat,1,160);
```

```

URXISEL1_U2STA_bit = 0;
URXISEL1_U2STA_bit = 0;
NSTDIS_bit = 1; // no nesting of interrupts
U2RXIF_bit = 0; // ensure interrupt not pending
U2RXIE_bit = 1; // enable interrupt

while (1){ // upon completed valid message receiving
// data[4] is set to 255

cnt++;
if (dat[5]) { // if an error detected, signal it
PORTD = 0xAA; // by setting portd to 0xAA
}
if (dat[4]) { // if message received successfully
cnt = 0;
dat[4] = 0; // clear message received flag
j = dat[3];
for (i = 1; i <= dat[3]; i++) { // show data on PORTB
PORTB = dat[i-1];
} // increment received dat[0]
dat[0] = dat[0]+1; // send back to master
Delay_ms(1);
RS485Master_Send(dat,1,160);

}
if (cnt > 100000) {
PORTD ++;
cnt = 0;
RS485Master_Send(dat,1,160);
if (PORTD > 10) // if sending failed 10 times
RS485Master_Send(dat,1,50); // send message on broadcast address
}
} // function to be properly linked.
}

```

RS485 Slave code:

Copy Code To Clipboard

```

sbit rs485_rtx_pin at RF2_bit; // set transcieve pin
sbit rs485_rtx_pin_direction at TRISF2_bit; // set transcieve pin direction

char dat[9]; // buffer for receving/sending messages
char i,j;

// Interrupt routine
void interrupt() org IVT_ADDR_U2RXINTERRUPT{
RS485Slave_Receive(dat);
U2RXIF_bit = 0; // ensure interrupt not pending
}

```

```
void main() {
    ADPCFG = 0xFFFF;

    PORTB = 0;
    PORTD = 0;
    TRISB = 0;
    TRISD = 0;

    UART2_Init(9600);           // initialize UART2 module
    Delay_ms(100);

    RS485Slave_Init(160);      // Intialize MCU as slave, address 160

    dat[0] = 0xAA;
    dat[1] = 0xF0;
    dat[2] = 0x0F;
    dat[4] = 0;                // ensure that message received flag is 0
    dat[5] = 0;                // ensure that error flag is 0
    dat[6] = 0;

    URXISEL1_U2STA_bit = 0;
    URXISEL1_U2STA_bit = 0;
    NSTDIS_bit = 1;           // no nesting of interrupts
    U2RXIF_bit = 0;          // ensure interrupt not pending
    U2RXIE_bit = 1;          // enable intterrupt

    while (1) {
        if (dat[5]) {         // if an error detected, signal it by
            PORTD = 0xAA;    // setting portd to 0xAA
            dat[5] = 0;
        }
        if (dat[4]) {        // upon completed valid message receive
            dat[4] = 0;      // data[4] is set to 0xFF
            j = dat[3];
            for (i = 1; i <= dat[3];i++){
                PORTB = dat[i-1];
            }
            dat[0] = dat[0]+1; // increment received dat[0]
            Delay_ms(1);
            RS485Slave_Send(dat,1); // and send it back to master
        }
    }
}
```

HW Connection

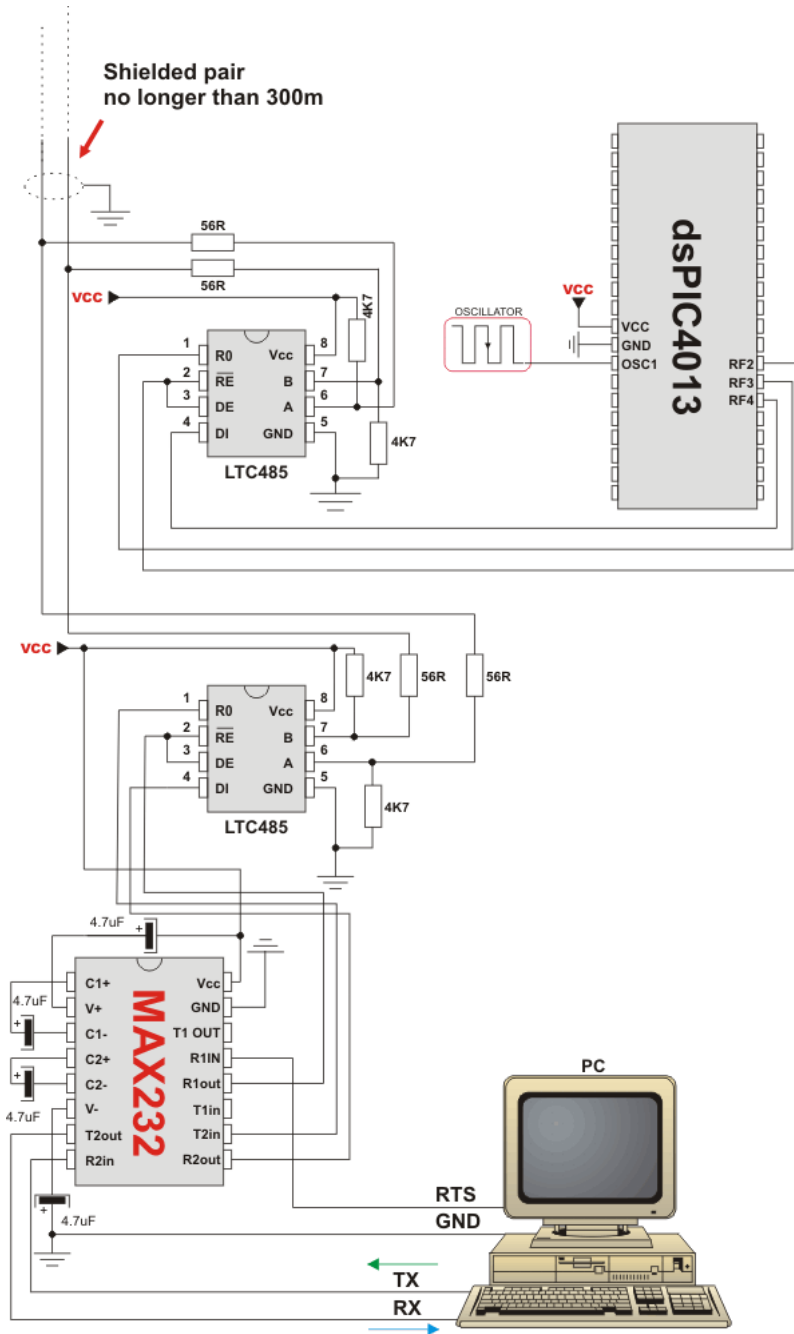

Example of interfacing PC to dsPIC MCU via RS485 bus with LTC485 as RS-485 transceiver

Message format and CRC calculations

Q: How is CRC checksum calculated on RS485 master side?

Copy Code To Clipboard

```
START_BYTE = 0x96; // 10010110
STOP_BYTE  = 0xA9; // 10101001
```

```
PACKAGE:
```

```
-----
```

```
START_BYTE 0x96
ADDRESS
DATALEN
[DATA1]          // if exists
[DATA2]          // if exists
[DATA3]          // if exists
CRC
STOP_BYTE  0xA9
```

```
DATALEN bits
```

```
-----
```

```
bit7 = 1 MASTER SENDS
      0 SLAVE SENDS
bit6 = 1 ADDRESS WAS XORed with 1, IT WAS EQUAL TO START_BYTE or STOP_BYTE
      0 ADDRESS UNCHANGED
bit5 = 0 FIXED
bit4 = 1 DATA3 (if exists) WAS XORed with 1, IT WAS EQUAL TO START_BYTE or STOP_BYTE
      0 DATA3 (if exists) UNCHANGED
bit3 = 1 DATA2 (if exists) WAS XORed with 1, IT WAS EQUAL TO START_BYTE or STOP_BYTE
      0 DATA2 (if exists) UNCHANGED
bit2 = 1 DATA1 (if exists) WAS XORed with 1, IT WAS EQUAL TO START_BYTE or STOP_BYTE
      0 DATA1 (if exists) UNCHANGED
bit1bit0 = 0 to 3 NUMBER OF DATA BYTES SEND
```

```
CRC generation :
```

```
-----
```

```
crc_send = datalen ^ address;
crc_send ^= data[0]; // if exists
crc_send ^= data[1]; // if exists
crc_send ^= data[2]; // if exists
crc_send = ~crc_send;
if ((crc_send == START_BYTE) || (crc_send == STOP_BYTE))
    crc_send++;
```

NOTE: DATALEN<4..0> can not take the START_BYTE<4..0> or STOP_BYTE<4..0> values.

Software I²C Library

The mikroC PRO for dsPIC30/33 and PIC24 provides routines for implementing Software I²C communication. These routines are hardware independent and can be used with any MCU. The Software I²C library enables you to use MCU as Master in I²C communication. Multi-master mode is not supported.

Important :

- This library implements time-based activities, so interrupts need to be disabled when using Software I²C.
- All I²C Library functions are blocking-call functions (they are waiting for I²C clock line to become logical one).
- The pins used for the Software I²C communication should be connected to the pull-up resistors. Turning off the LEDs connected to these pins may also be required.
- Every Software I²C library routine has its own counterpart in Hardware I²C library, except `I2C_Repeated_Start`. `Soft_I2C_Start` is used instead of `I2C_Repeated_Start`.
- Working clock frequency of the Software I²C is 20kHz.

External dependencies of Software I²C Library

The following variable must be defined in all projects using RS-485 Library:	Description :	Example :
<code>extern sbit Soft_I2C_Scl;</code>	Soft I ² C Clock line.	<code>sbit Soft_I2C_Scl at RB11_bit;</code>
<code>extern sbit Soft_I2C_Sda;</code>	Soft I ² C Data line.	<code>sbit Soft_I2C_Sda at RB12_bit;</code>
<code>extern sbit Soft_I2C_Scl_Direction;</code>	Direction of the Soft I ² C Clock pin.	<code>sbit Soft_I2C_Scl_Direction at TRISB11_bit;</code>
<code>extern sbit Soft_I2C_Sda_Direction;</code>	Direction of the Soft I ² C Data pin.	<code>sbit Soft_I2C_Sda_Direction at TRISB12_bit;</code>

Library Routines

- `Soft_I2C_Init`
- `Soft_I2C_Start`
- `Soft_I2C_Read`
- `Soft_I2C_Write`
- `Soft_I2C_Stop`
- `Soft_I2C_Break`

Soft_I2C_Init

Prototype	<code>void Soft_I2C_Init();</code>
Description	Configures the software I ² C module.
Parameters	None.
Returns	Nothing.
Requires	Global variables : <ul style="list-style-type: none"> - <code>Soft_I2C_Scl</code>: Soft I²C clock line - <code>Soft_I2C_Sda</code>: Soft I²C data line - <code>Soft_I2C_Scl_Pin_Direction</code>: Direction of the Soft I²C clock pin - <code>Soft_I2C_Sda_Pin_Direction</code>: Direction of the Soft I²C data pin must be defined before using this function.
Example	<pre>// Software I2C connections sbit Soft_I2C_Scl at RB11_bit; sbit Soft_I2C_Sda at RB12_bit; sbit Soft_I2C_Scl_Direction at TRISB11_bit; sbit Soft_I2C_Sda_Direction at TRISB12_bit; // End Software I2C connections ... Soft_I2C_Init();</pre>
Notes	None

Soft_I2C_Start

Prototype	<code>void Soft_I2C_Start();</code>
Description	Determines if the I ² C bus is free and issues START signal.
Parameters	None.
Returns	Nothing.
Requires	Software I ² C must be configured before using this function. See <code>Soft_I2C_Init</code> routine.
Example	<pre>// Issue START signal Soft_I2C_Start();</pre>
Notes	None

Soft_I2C_Read

Prototype	<code>unsigned short Soft_I2C_Read(unsigned int ack);</code>
Description	Reads one byte from the slave.
Parameters	- <code>ack</code> : acknowledge signal parameter. If the <code>ack==0</code> not acknowledge signal will be sent after reading, otherwise the acknowledge signal will be sent.
Returns	One byte from the Slave.
Requires	Soft I ² C must be configured before using this function. See <code>Soft_I2C_Init</code> routine. Also, START signal needs to be issued in order to use this function. See <code>Soft_I2C_Start</code> routine.
Example	<pre>unsigned short take; ... // Read data and send the not_acknowledge signal take = Soft_I2C_Read(0);</pre>
Notes	None

Soft_I2C_Write

Prototype	<code>unsigned short Soft_I2C_Write(unsigned short data_);</code>
Description	Sends data byte via the I ² C bus.
Parameters	- <code>data_</code> : data to be sent
Returns	- 0 if there were no errors. - 1 if write collision was detected on the I ² C bus.
Requires	Soft I ² C must be configured before using this function. See <code>Soft_I2C_Init</code> routine. Also, START signal needs to be issued in order to use this function. See <code>Soft_I2C_Start</code> routine.
Example	<pre>unsigned short data_, error; ... error = Soft_I2C_Write(data_); error = Soft_I2C_Write(0xA3);</pre>
Notes	None

Soft_I2C_Stop

Prototype	<code>void Soft_I2C_Stop();</code>
Description	Issues STOP signal.
Parameters	None.
Returns	Nothing.
Requires	Soft I ² C must be configured before using this function. See Soft_I2C_Init routine.
Example	<pre>// Issue STOP signal Soft_I2C_Stop();</pre>
Notes	None

Soft_I2C_Break

Prototype	<code>void Soft_I2C_Break();</code>
Description	All Software I ² C Library functions can block the program flow (see note at the top of this page). Calling this routine from interrupt will unblock the program execution. This mechanism is similar to WDT.
Parameters	None.
Returns	Nothing.
Requires	Nothing.
Example	<pre> // Software I2C connections sbit Soft_I2C_Scl at RC0_bit; sbit Soft_I2C_Sda at RC1_bit; sbit Soft_I2C_Scl_Direction at TRISC0_bit; sbit Soft_I2C_Sda_Direction at TRISC1_bit; // End Software I2C connections char counter = 0; void Timer1Int() org IVT_ADDR_T1INTERRUPT { if (counter >= 20) { Soft_I2C_Break(); counter = 0; // reset counter } else counter++; // increment counter T1IF_bit = 0; // Clear Timer1 overflow interrupt flag } void main() { ... // try Soft_I2C_Init with blocking prevention mechanism IPC0 = IPC0 0x1000; // Interrupt priority level = 1 T1IE_bit= 1; // Enable Timer1 interrupts T1CON = 0x8030; // Timer1 ON, internal clock FCY, prescaler 1:256 Soft_I2C_Init(); T1IE_bit= 0; // Disable Timer1 interrupts } </pre>
Notes	Interrupts should be disabled before using Software I ² C routines again (see note at the top of this page).

Library Example

The example demonstrates use of the Software I²C Library. The dsPIC30/33 or PIC24 MCU is connected (SCL, SDA pins) to PCF8583 RTC (real-time clock). Program sends date/time to RTC.

Copy Code To Clipboard

```
char seconds, minutes, hours, day, month, year;    // Global date/time variables

// Software I2C connections
sbit Soft_I2C_Scl      at RB11_bit;
sbit Soft_I2C_Sda      at RB12_bit;
sbit Soft_I2C_Scl_Direction at TRISB11_bit;
sbit Soft_I2C_Sda_Direction at TRISB12_bit;
// End Software I2C connections

// LCD module connections
sbit LCD_RS at LATD0_bit;
sbit LCD_EN at LATD1_bit;
sbit LCD_D4 at LATB0_bit;
sbit LCD_D5 at LATB1_bit;
sbit LCD_D6 at LATB2_bit;
sbit LCD_D7 at LATB3_bit;

sbit LCD_RS_Direction at TRISD0_bit;
sbit LCD_EN_Direction at TRISD1_bit;
sbit LCD_D4_Direction at TRISB0_bit;
sbit LCD_D5_Direction at TRISB1_bit;
sbit LCD_D6_Direction at TRISB2_bit;
sbit LCD_D7_Direction at TRISB3_bit;
// End LCD module connections

//----- Reads time and date information from RTC (PCF8583)
void Read_Time() {

Soft_I2C_Start();           // Issue start signal
  Soft_I2C_Write(0xA0);     // Address PCF8583, see PCF8583 datasheet
  Soft_I2C_Write(2);       // Start from address 2
  Soft_I2C_Start();       // Issue repeated start signal
  Soft_I2C_Write(0xA1);   // Address PCF8583 for reading R/W=1

  seconds = Soft_I2C_Read(1); // Read seconds byte
  minutes = Soft_I2C_Read(1); // Read minutes byte
  hours = Soft_I2C_Read(1);  // Read hours byte
  day = Soft_I2C_Read(1);    // Read year/day byte
  month = Soft_I2C_Read(0);  // Read weekday/month byte
  Soft_I2C_Stop();          // Issue stop signal

}
```

```

//----- Formats date and time
void Transform_Time() {
    seconds = ((seconds & 0xF0) >> 4)*10 + (seconds & 0x0F); // Transform seconds
    minutes = ((minutes & 0xF0) >> 4)*10 + (minutes & 0x0F); // Transform months
    hours = ((hours & 0xF0) >> 4)*10 + (hours & 0x0F); // Transform hours
    year = (day & 0xC0) >> 6; // Transform year
    day = ((day & 0x30) >> 4)*10 + (day & 0x0F); // Transform day
    month = ((month & 0x10) >> 4)*10 + (month & 0x0F); // Transform month
}

//----- Output values to LCD
void Display_Time() {

    Lcd_Chr(1, 6, (day / 10) + 48); // Print tens digit of day variable
    Lcd_Chr(1, 7, (day % 10) + 48); // Print oness digit of day variable
    Lcd_Chr(1, 9, (month / 10) + 48);
    Lcd_Chr(1,10, (month % 10) + 48);
    Lcd_Chr(1,15, year + 56); // Print year vaiable + 8 (start from year 2008)

    Lcd_Chr(2, 6, (hours / 10) + 48);
    Lcd_Chr(2, 7, (hours % 10) + 48);
    Lcd_Chr(2, 9, (minutes / 10) + 48);
    Lcd_Chr(2,10, (minutes % 10) + 48);
    Lcd_Chr(2,12, (seconds / 10) + 48);
    Lcd_Chr(2,13, (seconds % 10) + 48);
}

//----- Performs project-wide init
void Init_Main() {
    ADPCFG = 0xFFFF; // initialize AN pins as digital

    Soft_I2C_Init(); // Initialize Soft I2C communication
    Lcd_Init(); // Initialize LCD
    Lcd_Cmd(_LCD_CLEAR); // Clear LCD display
    Lcd_Cmd(_LCD_CURSOR_OFF); // Turn cursor off

    Lcd_Out(1,1,"Date:"); // Prepare and output static text on LCD
    Lcd_Chr(1,8,':');
    Lcd_Chr(1,11,':');
    Lcd_Out(2,1,"Time:");
    Lcd_Chr(2,8,':');
    Lcd_Chr(2,11,':');
    Lcd_Out(1,12,"200");
}

//----- Main procedure
void main() {

    Delay_ms(2000);

    Init_Main(); // Perform initialization

    while (1) { // Endless loop
        Read_Time(); // Read time from RTC(PCF8583)
        Transform_Time(); // Format date and time
        Display_Time(); // Prepare and display on LCD

        Delay_ms(1000); // Wait 1 second
    }
}

```

Software SPI Library

The mikroC PRO for dsPIC30/33 and PIC24 provides routines for implementing Software SPI communication. These routines are hardware independent and can be used with any MCU. The Software SPI Library provides easy communication with other devices via SPI: A/D converters, D/A converters, MAX7219, LTC1290, etc.

Library configuration:

- SPI to Master mode
- Clock value = 20 kHz.
- Data sampled at the middle of interval.
- Clock idle state low.
- Data sampled at the middle of interval.
- Data transmitted at low to high edge.

The library configures SPI to the master mode, clock = 20kHz, data sampled at the middle of interval, clock idle state low and data transmitted at low to high edge.

Important : The Software SPI library implements time-based activities, so interrupts need to be disabled when using it.

External dependencies of Software SPI Library

The following variables must be defined in all projects using Software SPI Library:	Description :	Example :
<code>extern sfr sbit SoftSpi_SDI;</code>	Data In line.	<code>sbit SoftSpi_SDI at RF4_bit;</code>
<code>extern sfr sbit SoftSpi_SDO;</code>	Data Out line.	<code>sbit SoftSpi_SDO at LATF3_bit;</code>
<code>extern sfr sbit SoftSpi_CLK;</code>	Clock line.	<code>sbit SoftSpi_CLK at LATF6_bit;</code>
<code>extern sfr sbit SoftSpi_SDI_Direction;</code>	Direction of the Data In pin.	<code>sbit SoftSpi_SDI_Direction at TRISF4_bit;</code>
<code>extern sfr sbit SoftSpi_SDO_Direction;</code>	Direction of the Data Out pin	<code>sbit SoftSpi_SDO_Direction at TRISF3_bit;</code>
<code>extern sfr sbit SoftSpi_CLK_Direction;</code>	Direction of the Clock pin.	<code>sbit SoftSpi_CLK_Direction at TRISF6_bit;</code>

Library Routines

- Soft_SPI_Init
- Soft_SPI_Read
- Soft_SPI_Write

Soft_SPI_Init

Prototype	<code>void Soft_SPI_Init();</code>
Description	Routine initializes the software SPI module.
Parameters	None.
Returns	Nothing.
Requires	<p>Global variables:</p> <ul style="list-style-type: none"> - <code>SoftSpi_SDI</code>: Data in line - <code>SoftSpi_SDO</code>: Data out line - <code>SoftSpi_CLK</code>: Data clock line - <code>SoftSpi_SDI_Direction</code>: Direction of the Data in pin - <code>SoftSpi_SDO_Direction</code>: Direction of the Data out pin - <code>SoftSpi_CLK_Direction</code>: Direction of the Data clock pin <p>must be defined before using this function.</p>
Example	<pre>// Software SPI module connections sbit SoftSpi_SDI at RF4_bit; sbit SoftSpi_SDO at LATF3_bit; sbit SoftSpi_CLK at LATF6_bit; sbit SoftSpi_SDI_Direction at TRISF4_bit; sbit SoftSpi_SDO_Direction at TRISF3_bit; sbit SoftSpi_CLK_Direction at TRISF6_bit; // End Software SPI module connections ... Soft_SPI_Init(); // Init Soft_SPI</pre>
Notes	None

Soft_SPI_Read

Prototype	<code>unsigned short Soft_SPI_Read(char sdata);</code>
Description	This routine performs 3 operations simultaneously. It provides clock for the Software SPI bus, reads a byte and sends a byte.
Parameters	- <code>sdata</code> : data to be sent.
Returns	Byte received via the SPI bus.
Requires	Soft SPI must be initialized before using this function. See <code>Soft_SPI_Init</code> routine.
Example	<pre> unsigned short data_read; char data_send; ... // Read a byte and assign it to data_read variable // (data_send byte will be sent via SPI during the Read operation) data_read = Soft_SPI_Read(data_send); </pre>
Notes	None

Soft_SPI_Write

Prototype	<code>void Soft_SPI_Write(char sdata);</code>
Description	This routine sends one byte via the Software SPI bus.
Parameters	- <code>sdata</code> : data to be sent.
Returns	Nothing.
Requires	Soft SPI must be initialized before using this function. See <code>Soft_SPI_Init</code> .
Example	<pre> // Write a byte to the Soft SPI bus Soft_SPI_Write(0xAA); </pre>
Notes	None

Library Example

This code demonstrates using library routines for `Soft_SPI` communication. Also, this example demonstrates working with `max7219`. Eight 7 segment displays are connected to `MAX7219`. `MAX7219` is connected to `SDO`, `SDI`, `SCK` pins are connected accordingly.

Copy Code To Clipboard

```

// DAC module connections
sbit Chip_Select at LATF0_bit;
sbit SoftSpi_CLK at LATF6_bit;
sbit SoftSpi_SDI at RF4_bit;
sbit SoftSpi_SDO at LATF3_bit;

sbit Chip_Select_Direction at TRISF0_bit;
sbit SoftSpi_CLK_Direction at TRISF6_bit;
sbit SoftSpi_SDI_Direction at TRISF4_bit;
sbit SoftSpi_SDO_Direction at TRISF3_bit;
// End DAC module connections

```

```

unsigned int value;

void InitMain() {
    TRISB0_bit = 1;           // Set RB0 pin as input
    TRISB1_bit = 1;           // Set RB1 pin as input
    Chip_Select = 1;          // Deselect DAC
    Chip_Select_Direction = 0; // Set CS# pin as Output
    Soft_SPI_Init();          // Initialize Soft_SPI
}

// DAC increments (0..4095) --> output voltage (0..Vref)
void DAC_Output(unsigned int valueDAC) {
    char temp;

    Chip_Select = 0;          // Select DAC chip

    // Send High Byte
    temp = (valueDAC >> 8) & 0x0F; // Store valueDAC[11..8] to temp[3..0]
    temp |= 0x30;              // Define DAC setting, see MCP4921 datasheet
    Soft_SPI_Write(temp);      // Send high byte via Soft SPI

    // Send Low Byte
    temp = valueDAC;           // Store valueDAC[7..0] to temp[7..0]
    Soft_SPI_Write(temp);     // Send low byte via Soft SPI

    Chip_Select = 1;          // Deselect DAC chip
}

void main() {

    ADPCFG = 0xFFFF;         // Configure AN pins as digital

    InitMain();              // Perform main initialization

    value = 2048;             // When program starts, DAC gives
                              // the output in the mid-range

    while (1) {              // Endless loop

        if ((RB0_bit) && (value < 4095)) { // If RB0 button is pressed
            value++;                // increment value
        }
        else {
            if ((RB1_bit) && (value > 0)) { // If RB1 button is pressed
                value--;            // decrement value
            }
        }

        DAC_Output(value);         // Send value to DAC chip
        Delay_ms(1);              // Slow down key repeat pace
    }
}

```

Software UART Library

The mikroC PRO for dsPIC30/33 and PIC24 provides routines for implementing Software UART communication. These routines are hardware independent and can be used with any MCU.

The Software UART Library provides easy communication with other devices via the RS232 protocol.

Important : The Software UART library implements time-based activities, so interrupts need to be disabled when using it.

Library Routines

- Soft_UART_Init
- Soft_UART_Read
- Soft_UART_Write
- Soft_UART_Break

Soft_UART_Init

Prototype	<code>char Soft_UART_Init(unsigned int *port, unsigned int rx, unsigned int tx, unsigned long baud_rate, unsigned int inverted);</code>
Description	Configures and initializes the software UART module. Software UART routines use Delay_Cyc routine. If requested baud rate is too low then calculated parameter for calling Delay_Cyc exceeds Delay_Cyc argument range. If requested baud rate is too high then rounding error of Delay_Cyc argument corrupts Software UART timings.
Parameters	- <code>port</code> : software UART port address - <code>rx</code> : receiver pin - <code>tx</code> : transmitter pin - <code>baud_rate</code> : requested baudrate. Maximum baud rate depends on the MCU's clock and working conditions - <code>inverted</code> : if set to non-zero value, indicates inverted logic on output
Returns	- <code>2</code> - error, requested baud rate is too low - <code>1</code> - error, requested baud rate is too high - <code>0</code> - successful initialization
Requires	Nothing.
Example	This will initialize software UART and establish the communication at 9600 bps: <pre>char error; ... error = Soft_UART_Init(&PORTF, 4, 5, 14400, 0); // Initialize Soft UART at 14400 bps</pre>
Notes	The Software UART library implements time-based activities, so interrupts need to be disabled when using it.

Soft_UART_Read

Prototype	<code>char Soft_UART_Read(char *error);</code>
Description	The function receives a byte via software UART. This is a blocking function call (waits for start bit). Programmer can unblock it by calling Soft_UART_Break routine.
Parameters	- <code>error</code> : Error flag. Error code is returned through this variable. Values : - 0 - no error - 1 - stop bit error - 255 - user abort, Soft_UART_Break called
Returns	Byte received via UART.
Requires	Software UART must be initialized before using this function. See the Soft_UART_Init routine.
Example	<pre> char data_; char error; ... // wait until data is received do data = Soft_UART_Read(&error); while (error); // Now we can work with data: if (data_) {...} </pre>
Notes	The Software UART library implements time-based activities, so interrupts need to be disabled when using it.

Soft_UART_Write

Prototype	<code>void Soft_UART_Write(char udata);</code>
Description	This routine sends one byte via the Software UART bus.
Parameters	- <code>udata</code> : data to be sent.
Returns	Nothing.
Requires	Software UART must be initialized before using this function. See the Soft_UART_Init routine. Be aware that during transmission, software UART is incapable of receiving data – data transfer protocol must be set in such a way to prevent loss of information.
Example	<pre> char some_byte = 0x0A; ... // Write a byte via Soft UART Soft_UART_Write(some_byte); </pre>
Notes	The Software UART library implements time-based activities, so interrupts need to be disabled when using it.

Soft_UART_Break

Prototype	<code>void Soft_UART_Break();</code>
Description	Soft_UART_Read is blocking routine and it can block the program flow. Calling Soft_UART_Break routine from the interrupt will unblock the program execution. This mechanism is similar to WDT.
Parameters	None.
Returns	Nothing.
Requires	Nothing.
Example	<pre> char data1, error, counter = 0; void Timer1Int() org IVT_ADDR_T1INTERRUPT { if (counter >= 20) { Soft_UART_Break(); counter = 0; // reset counter } else counter++; // increment counter T1IF_bit = 0; // Clear Timer1 overflow interrupt flag } void main() { ... if (Soft_UART_Init(&PORTF, 4, 5, 14400, 0) = 0) Soft_UART_Write(0x55); ... // try Soft_UART_Read with blocking prevention mechanism IPC0 = IPC0 0x1000; // Interrupt priority level = 1 T1IE_bit= 1; // Enable Timer1 interrupts T1CON = 0x8030; // Timer1 ON, internal clock FCY, prescaler 1:256 data1 = Soft_UART_Read(&error); T1IE_bit= 0; // Disable Timer1 interrupts } </pre>
Notes	The Software UART library implements time-based activities, so interrupts need to be disabled when using it.

Library Example

This example demonstrates simple data exchange via software UART. If MCU is connected to the PC, you can test the example from the mikroC PRO for dsPIC30/33 and PIC24 USART communication terminal, launch it from the drop-down menu Tools › USART Terminal or simply click the USART Terminal Icon  .

Copy Code To Clipboard

```

char i, error, byte_read; // Auxiliary variables

void main(){

    ADPCFG = 0xFFFF;

    TRISB = 0;           // Set PORTB as output (error signalization)
    LATB = 0;

    error = Soft_UART_Init(&PORTF, 4, 5, 14400, 0); // Initialize Soft UART at 14400 bps
    if (error > 0) {
        LATB = error;           // Signalize Init error
        while(1);              // Stop program
    }
    Delay_ms(100);

    for (i = 'z'; i >= 'A'; i--) { // Send bytes from 'z' downto 'A'
        Soft_UART_Write(i);
        Delay_ms(100);
    }

    while(1) { // Endless loop
        byte_read = Soft_UART_Read(&error); // Read byte, then test error flag
        if (error) // If error was detected
            LATB = error; // signal it on PORTB
        else
            Soft_UART_Write(byte_read); // If error was not detected, return
    }
}

```

Sound Library

The mikroC PRO for dsPIC30/33 and PIC24 provides a Sound Library to supply users with routines necessary for sound signalization in their applications. Sound generation needs additional hardware, such as piezo-speaker (example of piezo-speaker interface is given on the schematic at the bottom of this page).

Library Routines

- Sound_Init
- Sound_Play

Sound_Init

Prototype	<code>void Sound_Init(unsigned int *snd_port, unsigned< int/b> snd_pin);</code>
Description	Configures the appropriate MCU pin for sound generation.
Parameters	- <code>snd_port</code> : sound output port address - <code>snd_pin</code> : sound output pin
Returns	Nothing.
Requires	Nothing.
Example	<pre>// Initialize the pin RC3 for playing sound Sound_Init(&PORTD, 3);</pre>
Notes	None.

Sound_Play

Prototype	<code>void Sound_Play(unsigned int freq_in_hz, unsigned< int/b> duration_ms);</code>
Description	Generates the square wave signal on the appropriate pin.
Parameters	- <code>freq_in_hz</code> : signal frequency in Hertz (Hz) - <code>duration_ms</code> : signal duration in milliseconds (ms)
Returns	Nothing.
Requires	In order to hear the sound, you need a piezo speaker (or other hardware) on designated port. Also, you must call Sound_Init to prepare hardware for output before using this function.
Example	<pre>// Play sound of 1KHz in duration of 100ms Sound_Play(1000, 100);</pre>
Notes	None.

Library Example

The example is a simple demonstration of how to use the Sound Library for playing tones on a piezo speaker.

Copy Code To Clipboard

```

void Tone1() {
    Sound_Play(659, 250);    // Frequency = 659Hz, duration = 250ms
}

void Tone2() {
    Sound_Play(698, 250);    // Frequency = 698Hz, duration = 250ms
}

void Tone3() {
    Sound_Play(784, 250);    // Frequency = 784Hz, duration = 250ms
}

void Melody() {              // Plays the melody "Yellow house"
    Tone1(); Tone2(); Tone3(); Tone3();
    Tone1(); Tone2(); Tone3(); Tone3();
    Tone1(); Tone2(); Tone3();
    Tone1(); Tone2(); Tone3(); Tone3();
    Tone1(); Tone2(); Tone3();
    Tone3(); Tone3(); Tone2(); Tone2(); Tone1();
}

void ToneA() {
    Sound_Play( 880, 50);
}
void ToneC() {
    Sound_Play(1046, 50);
}
void ToneE() {
    Sound_Play(1318, 50);
}

void Melody2() {
    unsigned short i;
    for (i = 9; i > 0; i--) {
        ToneA(); ToneC(); ToneE();
    }
}

void main() {

    ADPCFG = 0xFFFF;          // Configure AN pins as digital
    TRISB = 0xF8;             // Configure RB7..RB3 as input
    LATB = 0;

    Sound_Init(&PORTD, 3);
    Sound_Play(880, 1000);     // Play sound at 880Hz for 1 second
}

```

```

while (1) {
    if (Button(&PORTB,7,1,1))           // RB7 plays Tone1
        Tone1();
    while (RB7_bit);                   // Wait for button to be released

    if (Button(&PORTB,6,1,1))           // RB6 plays Tone2
        Tone2();
    while (RB6_bit);                   // Wait for button to be released

    if (Button(&PORTB,5,1,1))           // RB5 plays Tone3
        Tone3();
    while (RB5_bit);                   // Wait for button to be released

    if (Button(&PORTB,4,1,1))           // RB4 plays Melody2
        Melody2();
    while (RB4_bit);                   // Wait for button to be released

    if (Button(&PORTB,3,1,1))           // RB3 plays Melody
        Melody();
    while (RB3_bit);                   // Wait for button to be released
}
}

```

HW Connection

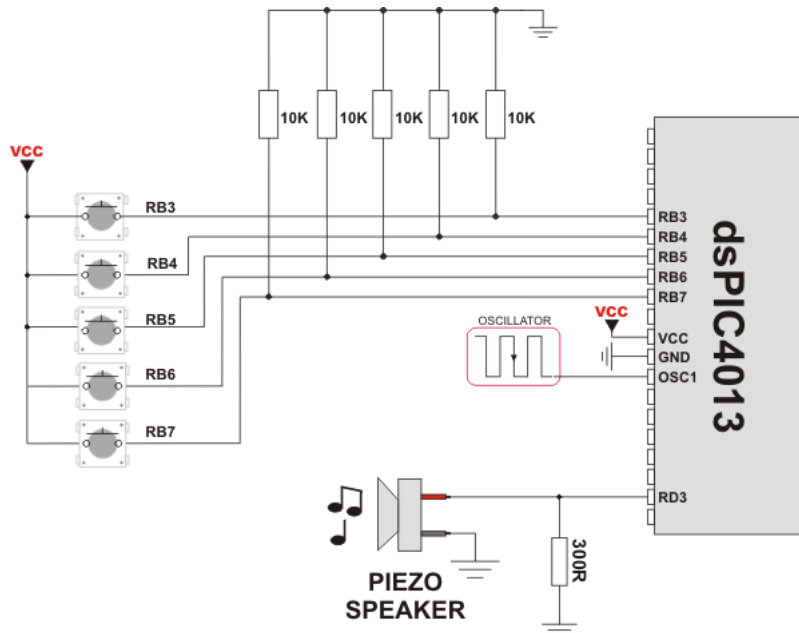

Example of Sound Library

SPI Library

The SPI module is available with all dsPIC30/33 and PIC24 MCUs. mikroC PRO for dsPIC30/33 and PIC24 provides a library for initializing the Slave mode and initializing and comfortable work with the Master mode. The dsPIC30/33 and PIC24 can easily communicate with other devices via SPI: A/D converters, D/A converters, MAX7219, LTC1290, etc.

Important :

SPI library routines require you to specify the module you want to use. To select the desired SPI module, simply change the letter x in the routine prototype for a number from 1 to 3.

Number of SPI modules per MCU differs from chip to chip. Please, read the appropriate datasheet before utilizing this library.

Switching between the SPI modules in the SPI library is done by the SPI_Set_Active function (both SPI modules have to be previously initialized).

Library Routines

- SPIx_Init
- SPIx_Init_Advanced
- SPIx_Read
- SPIx_Write
- SPI_Set_Active

SPIx_Init

Prototype	<code>void SPIx_Init();</code>
Description	<p>Configures and initializes the SPI module with default settings.</p> <p>Default settings:</p> <ul style="list-style-type: none"> - Master mode - 8-bit data mode - secondary prescaler 1:1 - primary prescaler 64:1 - Slave Select disabled - input data sampled in the middle of interval - clock idle state low - Serial output data changes on transition from active clock state to idle clock state
Parameters	None.
Returns	Nothing.
Requires	MCU must have the SPI1 module.
Example	<pre>// Initialize the SPI1 module with default settings SPI1_Init();</pre>
Notes	<p>SPI library routines require you to specify the module you want to use. To select the desired SPI module, simply change the letter x in the routine prototype for a number from 1 to 3.</p> <p>Number of SPI modules per MCU differs from chip to chip. Please, read the appropriate datasheet before utilizing this library.</p> <p>Switching between the SPI modules in the SPI library is done by the SPI_Set_Active function (both SPI modules have to be previously initialized).</p>

SPIx_Init_Advanced

Prototype	<code>void SPIx_Init_Advanced(unsigned master_mode, unsigned mode16, unsigned sec_prescaler, unsigned pri_prescaler, unsigned slave_select, unsigned data_sample, unsigned clock_idle, unsigned edge);</code>																																																
Description	Configures and initializes the SPI module with user defined settings.																																																
Parameters	<p>Parameters <code>master_mode</code>, <code>mode16</code>, <code>sec_prescaler</code>, <code>pri_prescaler</code>, <code>slave_select</code>, <code>data_sample</code>, <code>clock_idle</code> and determine the working mode for SPI.</p> <p>The <code>master_mode</code> parameter determines the working mode for SPI module.</p> <table border="1"> <thead> <tr> <th colspan="2">Master/Slave mode</th> </tr> <tr> <th>Description</th> <th>Predefined library const</th> </tr> </thead> <tbody> <tr> <td>Master mode</td> <td><code>_SPI_MASTER</code></td> </tr> <tr> <td>Slave mode</td> <td><code>_SPI_SLAVE</code></td> </tr> </tbody> </table> <p>The parameter <code>mode16</code> determines the data length mode, which can be 8-bits (per transmissions cycle) or 16-bits.</p> <table border="1"> <thead> <tr> <th colspan="2">Data Length Mode</th> </tr> <tr> <th>Description</th> <th>Predefined library const</th> </tr> </thead> <tbody> <tr> <td>16-bit mode</td> <td><code>_SPI_16_BIT</code></td> </tr> <tr> <td>8-bit mode</td> <td><code>_SPI_8_BIT</code></td> </tr> </tbody> </table> <p>The parameter <code>sec_prescaler</code> determines the value of the secondary SPI clock prescaler. Used only in the Master Mode.</p> <table border="1"> <thead> <tr> <th colspan="2">Secondary SPI Clock Prescaler Value</th> </tr> <tr> <th>Description</th> <th>Predefined library const</th> </tr> </thead> <tbody> <tr> <td>Secondary Prescaler 1:1</td> <td><code>_SPI_PRESCALE_SEC_1</code></td> </tr> <tr> <td>Secondary Prescaler 1:2</td> <td><code>_SPI_PRESCALE_SEC_2</code></td> </tr> <tr> <td>Secondary Prescaler 1:3</td> <td><code>_SPI_PRESCALE_SEC_3</code></td> </tr> <tr> <td>Secondary Prescaler 1:4</td> <td><code>_SPI_PRESCALE_SEC_4</code></td> </tr> <tr> <td>Secondary Prescaler 1:5</td> <td><code>_SPI_PRESCALE_SEC_5</code></td> </tr> <tr> <td>Secondary Prescaler 1:6</td> <td><code>_SPI_PRESCALE_SEC_6</code></td> </tr> <tr> <td>Secondary Prescaler 1:7</td> <td><code>_SPI_PRESCALE_SEC_7</code></td> </tr> <tr> <td>Secondary Prescaler 1:8</td> <td><code>_SPI_PRESCALE_SEC_8</code></td> </tr> </tbody> </table> <p>The parameter <code>pri_prescaler</code> determines the value of the primary SPI clock prescaler. Used only in the Master Mode.</p> <table border="1"> <thead> <tr> <th colspan="2">Primary SPI Clock Prescaler Value</th> </tr> <tr> <th>Description</th> <th>Predefined library const</th> </tr> </thead> <tbody> <tr> <td>Primary Prescaler 1:1</td> <td><code>_SPI_PRESCALE_PRI_1</code></td> </tr> <tr> <td>Primary Prescaler 4:1</td> <td><code>_SPI_PRESCALE_PRI_4</code></td> </tr> <tr> <td>Primary Prescaler 16:1</td> <td><code>_SPI_PRESCALE_PRI_16</code></td> </tr> <tr> <td>Primary Prescaler 64:1</td> <td><code>_SPI_PRESCALE_PRI_64</code></td> </tr> </tbody> </table>	Master/Slave mode		Description	Predefined library const	Master mode	<code>_SPI_MASTER</code>	Slave mode	<code>_SPI_SLAVE</code>	Data Length Mode		Description	Predefined library const	16-bit mode	<code>_SPI_16_BIT</code>	8-bit mode	<code>_SPI_8_BIT</code>	Secondary SPI Clock Prescaler Value		Description	Predefined library const	Secondary Prescaler 1:1	<code>_SPI_PRESCALE_SEC_1</code>	Secondary Prescaler 1:2	<code>_SPI_PRESCALE_SEC_2</code>	Secondary Prescaler 1:3	<code>_SPI_PRESCALE_SEC_3</code>	Secondary Prescaler 1:4	<code>_SPI_PRESCALE_SEC_4</code>	Secondary Prescaler 1:5	<code>_SPI_PRESCALE_SEC_5</code>	Secondary Prescaler 1:6	<code>_SPI_PRESCALE_SEC_6</code>	Secondary Prescaler 1:7	<code>_SPI_PRESCALE_SEC_7</code>	Secondary Prescaler 1:8	<code>_SPI_PRESCALE_SEC_8</code>	Primary SPI Clock Prescaler Value		Description	Predefined library const	Primary Prescaler 1:1	<code>_SPI_PRESCALE_PRI_1</code>	Primary Prescaler 4:1	<code>_SPI_PRESCALE_PRI_4</code>	Primary Prescaler 16:1	<code>_SPI_PRESCALE_PRI_16</code>	Primary Prescaler 64:1	<code>_SPI_PRESCALE_PRI_64</code>
Master/Slave mode																																																	
Description	Predefined library const																																																
Master mode	<code>_SPI_MASTER</code>																																																
Slave mode	<code>_SPI_SLAVE</code>																																																
Data Length Mode																																																	
Description	Predefined library const																																																
16-bit mode	<code>_SPI_16_BIT</code>																																																
8-bit mode	<code>_SPI_8_BIT</code>																																																
Secondary SPI Clock Prescaler Value																																																	
Description	Predefined library const																																																
Secondary Prescaler 1:1	<code>_SPI_PRESCALE_SEC_1</code>																																																
Secondary Prescaler 1:2	<code>_SPI_PRESCALE_SEC_2</code>																																																
Secondary Prescaler 1:3	<code>_SPI_PRESCALE_SEC_3</code>																																																
Secondary Prescaler 1:4	<code>_SPI_PRESCALE_SEC_4</code>																																																
Secondary Prescaler 1:5	<code>_SPI_PRESCALE_SEC_5</code>																																																
Secondary Prescaler 1:6	<code>_SPI_PRESCALE_SEC_6</code>																																																
Secondary Prescaler 1:7	<code>_SPI_PRESCALE_SEC_7</code>																																																
Secondary Prescaler 1:8	<code>_SPI_PRESCALE_SEC_8</code>																																																
Primary SPI Clock Prescaler Value																																																	
Description	Predefined library const																																																
Primary Prescaler 1:1	<code>_SPI_PRESCALE_PRI_1</code>																																																
Primary Prescaler 4:1	<code>_SPI_PRESCALE_PRI_4</code>																																																
Primary Prescaler 16:1	<code>_SPI_PRESCALE_PRI_16</code>																																																
Primary Prescaler 64:1	<code>_SPI_PRESCALE_PRI_64</code>																																																

Parameters	<p>The parameter <code>slave_select</code> determines whether the Slave Select (SS) pin is used in communication. Valid in the Slave Mode only.</p> <table border="1"> <thead> <tr> <th colspan="2">Slave Select Enable/Disable</th> </tr> <tr> <th>Description</th> <th>Predefined library const</th> </tr> </thead> <tbody> <tr> <td><code>SS used for the Slave mode</code></td> <td><code>_SPI_SS_ENABLE</code></td> </tr> <tr> <td><code>SS not used for the Slave mode</code></td> <td><code>_SPI_SS_DISABLE</code></td> </tr> </tbody> </table> <p>The parameter <code>data_sample</code> determines the sample moment (phase) of input data.</p> <table border="1"> <thead> <tr> <th colspan="2">Data Sampling Moment</th> </tr> <tr> <th>Description</th> <th>Predefined library const</th> </tr> </thead> <tbody> <tr> <td><code>Data sampled in the middle of data output time</code></td> <td><code>_SPI_DATA_SAMPLE_MIDDLE</code></td> </tr> <tr> <td><code>Data sampled at end of data output time</code></td> <td><code>_SPI_DATA_SAMPLE_END</code></td> </tr> </tbody> </table> <p>The parameter <code>clock_idle</code> determines the behaviour of the SPI clock (CLK) line in IDLE phase.</p> <table border="1"> <thead> <tr> <th colspan="2">Clock Polarity</th> </tr> <tr> <th>Description</th> <th>Predefined library const</th> </tr> </thead> <tbody> <tr> <td><code>IDLE state is Lo, ACTIVE state is Hi</code></td> <td><code>_SPI_CLK_IDLE_LOW</code></td> </tr> <tr> <td><code>IDLE state is Hi, ACTIVE state is Lo</code></td> <td><code>_SPI_CLK_IDLE_HIGH</code></td> </tr> </tbody> </table> <p>The parameter <code>edge</code> determines on which clock edge data is considered to be valid.</p> <table border="1"> <thead> <tr> <th colspan="2">Clock Edge</th> </tr> <tr> <th>Description</th> <th>Predefined library const</th> </tr> </thead> <tbody> <tr> <td><code>Data is valid on ACTIVE-to-IDLE transition</code></td> <td><code>_SPI_ACTIVE_2_IDLE</code></td> </tr> <tr> <td><code>Data is valid on IDLE-to-ACTIVE transition</code></td> <td><code>_SPI_IDLE_2_ACTIVE</code></td> </tr> </tbody> </table>	Slave Select Enable/Disable		Description	Predefined library const	<code>SS used for the Slave mode</code>	<code>_SPI_SS_ENABLE</code>	<code>SS not used for the Slave mode</code>	<code>_SPI_SS_DISABLE</code>	Data Sampling Moment		Description	Predefined library const	<code>Data sampled in the middle of data output time</code>	<code>_SPI_DATA_SAMPLE_MIDDLE</code>	<code>Data sampled at end of data output time</code>	<code>_SPI_DATA_SAMPLE_END</code>	Clock Polarity		Description	Predefined library const	<code>IDLE state is Lo, ACTIVE state is Hi</code>	<code>_SPI_CLK_IDLE_LOW</code>	<code>IDLE state is Hi, ACTIVE state is Lo</code>	<code>_SPI_CLK_IDLE_HIGH</code>	Clock Edge		Description	Predefined library const	<code>Data is valid on ACTIVE-to-IDLE transition</code>	<code>_SPI_ACTIVE_2_IDLE</code>	<code>Data is valid on IDLE-to-ACTIVE transition</code>	<code>_SPI_IDLE_2_ACTIVE</code>
	Slave Select Enable/Disable																																
	Description	Predefined library const																															
	<code>SS used for the Slave mode</code>	<code>_SPI_SS_ENABLE</code>																															
	<code>SS not used for the Slave mode</code>	<code>_SPI_SS_DISABLE</code>																															
	Data Sampling Moment																																
	Description	Predefined library const																															
	<code>Data sampled in the middle of data output time</code>	<code>_SPI_DATA_SAMPLE_MIDDLE</code>																															
	<code>Data sampled at end of data output time</code>	<code>_SPI_DATA_SAMPLE_END</code>																															
	Clock Polarity																																
Description	Predefined library const																																
<code>IDLE state is Lo, ACTIVE state is Hi</code>	<code>_SPI_CLK_IDLE_LOW</code>																																
<code>IDLE state is Hi, ACTIVE state is Lo</code>	<code>_SPI_CLK_IDLE_HIGH</code>																																
Clock Edge																																	
Description	Predefined library const																																
<code>Data is valid on ACTIVE-to-IDLE transition</code>	<code>_SPI_ACTIVE_2_IDLE</code>																																
<code>Data is valid on IDLE-to-ACTIVE transition</code>	<code>_SPI_IDLE_2_ACTIVE</code>																																
Returns	Nothing.																																
Requires	MCU must have the SPI module.																																
Example	<pre>// Set SPI1 to the Master Mode, data length is 16-bit, clock = Fcy (no clock scaling), data sampled in the middle of interval, clock IDLE state high and data transmitted at low to high clock edge: SPI1_Init_Advanced(_SPI_MASTER, _SPI_16_BIT, _SPI_PRESCALE_SEC_1, _SPI_ PRESCALE_PRI_1, _SPI_SS_DISABLE, _SPI_DATA_SAMPLE_MIDDLE, _SPI_CLK_IDLE_ HIGH, _SPI_ACTIVE_2_IDLE);</pre>																																
Notes	<p>SPI library routines require you to specify the module you want to use. To select the desired SPI module, simply change the letter x in the routine prototype for a number from 1 to 3.</p> <p>Number of SPI modules per MCU differs from chip to chip. Please, read the appropriate datasheet before utilizing this library.</p>																																

SPIx_Read

Prototype	<code>unsigned SPIx_Read(unsigned buffer);</code>
Description	Reads one word or byte (depending on mode set by init routines) from the SPI bus.
Parameters	- <code>data_out</code> : dummy data for clock generation (see device Datasheet for SPI modules implementation details)
Returns	Received data.
Requires	Routine requires at least one SPI module. Used SPI module must be initialized before using this function. See the SPIx_Init and SPIx_Init_Advanced routines.
Example	<pre>// read a byte from the SPI bus char take, buffer; ... take = SPI1_Read(buffer);</pre>
Notes	SPI library routines require you to specify the module you want to use. To select the desired SPI module, simply change the letter x in the routine prototype for a number from 1 to 3 . Number of SPI modules per MCU differs from chip to chip. Please, read the appropriate datasheet before utilizing this library.

SPIx_Write

Prototype	<code>void SPIx_Write(unsigned data_out);</code>
Description	Writes one word or byte (depending on mode set by init routines) via the SPI bus.
Parameters	- <code>data_out</code> : data to be sent
Returns	Received data.
Requires	Routine requires at least one SPI module. Used SPI module must be initialized before using this function. See the SPIx_Init and SPIx_Init_Advanced routines.
Example	<pre>// write a byte to the SPI bus char buffer; ... SPI1_Write(buffer);</pre>
Notes	SPI library routines require you to specify the module you want to use. To select the desired SPI module, simply change the letter x in the routine prototype for a number from 1 to 3 . Number of SPI modules per MCU differs from chip to chip. Please, read the appropriate datasheet before utilizing this library.

SPI_Set_Active

Prototype	<code>void SPI_Set_Active(unsigned (*read_ptr)(unsigned), void(*write_ptr)(unsigned));</code>
Description	Sets the active SPI module which will be used by the SPIx_Read and SPIx_Write routines.
Parameters	Parameters : - <code>read_ptr</code> : SPI1_Read handler - <code>write_ptr</code> : SPI1_Write handler
Returns	Nothing.
Requires	Routine is available only for MCUs with multiple SPI modules. Used SPI module must be initialized before using this function. See the SPIx_Init and SPIx_Init_Advanced routines.
Example	<code>SPI_Set_Active(SPI1_Read, SPI1_Write); // Sets the SPI1 module active</code>
Notes	Number of SPI modules per MCU differs from chip to chip. Please, read the appropriate datasheet before utilizing this library.

Library Example

The code demonstrates how to use SPI library functions for communication between SPI2 module of the MCU and MCP4921 DAC chip.

Copy Code To Clipboard

```
// DAC module connections
sbit Chip_Select at LATF0_bit;
sbit Chip_Select_Direction at TRISF0_bit;
// End DAC module connections

unsigned int value;

void InitMain() {
    TRISB0_bit = 1;           // Set RB0 pin as input
    TRISB1_bit = 1;           // Set RB1 pin as input
    Chip_Select = 1;          // Deselect DAC
    Chip_Select_Direction = 0; // Set CS# pin as Output
    SPI1_Init();              // Initialize SPI module
}

// DAC increments (0..4095) --> output voltage (0..Vref)
void DAC_Output(unsigned int valueDAC) {
    char temp;

    Chip_Select = 0;          // Select DAC chip

    // Send High Byte
    temp = (valueDAC >> 8) & 0x0F; // Store valueDAC[11..8] to temp[3..0]
    temp |= 0x30;              // Define DAC setting, see MCP4921 datasheet
    SPI1_Write(temp);          // Send high byte via SPI
}
```

```

// Send Low Byte
temp = valueDAC; // Store valueDAC[7..0] to temp[7..0]
SPI1_Write(temp); // Send low byte via SPI

Chip_Select = 1; // Deselect DAC chip
}

void main() {

ADPCFG = 0xFFFF; // Configure AN pins as digital

InitMain(); // Perform main initialization

value = 2048; // When program starts, DAC gives
// the output in the mid-range

while (1) { // Endless loop

if ((RB0_bit) && (value < 4095)) { // If RB0 button is pressed
value++; // increment value
}
else {
if ((RB1_bit) && (value > 0)) { // If RB1 button is pressed
value--; // decrement value
}
}
DAC_Output(value); // Send value to DAC chip
Delay_ms(1); // Slow down key repeat pace
}
}

```

HW Connection

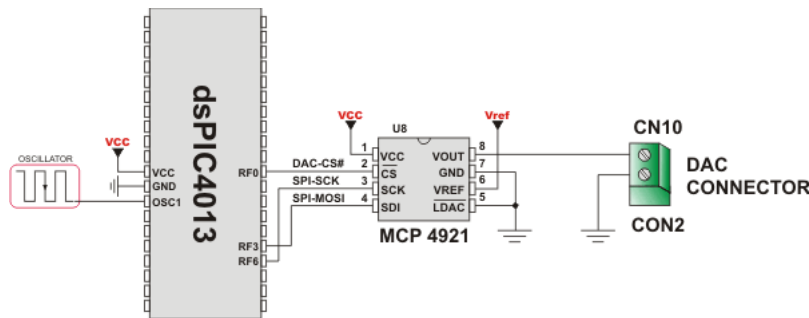

SPI HW connection

SPI Ethernet Library

The [ENC28J60](#) is a stand-alone Ethernet controller with an industry standard Serial Peripheral Interface (SPI). It is designed to serve as an Ethernet network interface for any controller equipped with SPI.

The [ENC28J60](#) meets all of the IEEE 802.3 specifications. It incorporates a number of packet filtering schemes to limit incoming packets. It also provides an internal DMA module for fast data throughput and hardware assisted IP checksum calculations. Communication with the host controller is implemented via two interrupt pins and the SPI, with data rates of up to 10 Mb/s. Two dedicated pins are used for LED link and network activity indication.

This library is designed to simplify handling of the underlying hardware ([ENC28J60](#)). It works with any dsPIC30/33 and PIC24 with integrated SPI and more than 4 Kb ROM memory. 38 to 40 MHz clock is recommended to get from 8 to 10 Mhz SPI clock, otherwise dsPIC30/33 and PIC24 should be clocked by ENC28J60 clock output due to its silicon bug in SPI hardware. If you try lower dsPIC30/33 and PIC24 clock speed, there might be board hang or miss some requests.

SPI Ethernet library supports:

- IPv4 protocol.
- ARP requests.
- ICMP echo requests.
- UDP requests.
- TCP requests (no stack, no packet reconstruction).
- ARP client with cache.
- DNS client.
- UDP client.
- DHCP client.
- packet fragmentation is **NOT** supported.

Important :

- Global library variable [SPI_Ethernet_userTimerSec](#) is used to keep track of time for all client implementations (ARP, DNS, UDP and DHCP). It is user responsibility to increment this variable each second in it's code if any of the clients is used.
- For advanced users there are header files ("[eth_enc28j60LibDef.h](#)" and "[eth_enc28j60LibPrivate.h](#)") in Uses folder of the compiler with description of all routines and global variables, relevant to the user, implemented in the SPI Ethernet Library.
- The appropriate hardware SPI module must be initialized before using any of the SPI Ethernet library routines. Refer to SPI Library.
- For MCUs with multiple SPI modules it is possible to initialize them and then switch by using the [SPI_Set_Active\(\)](#) routine.

Library Dependency Tree

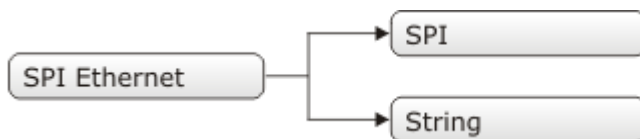

External dependencies of SPI Ethernet Library

The following variables must be defined in all projects using SPI Ethernet Library:	Description :	Example :
<code>extern sfr sbit SPI_Ethernet_CS;</code>	ENC28J60 chip select pin.	<code>sbit SPI_Ethernet_CS at LATF1_bit;</code>
<code>extern sfr sbit SPI_Ethernet_RST;</code>	ENC28J60 reset pin.	<code>sbit SPI_Ethernet_Rst at LATF0_bit;</code>
<code>extern sfr sbit SPI_Ethernet_CS_Direction;</code>	Direction of the ENC28J60 chip select pin.	<code>sbit SPI_Ethernet_CS_Direction at TRISF1_bit;</code>
<code>extern sfr sbit SPI_Ethernet_RST_Direction;</code>	Direction of the ENC28J60 reset pin.	<code>sbit SPI_Ethernet_Rst_Direction at TRISF0_bit;</code>
The following routines must be defined in all project using SPI Ethernet Library:	Description:	Examples :
<code>unsigned int SPI_Ethernet_UserTCP(unsigned char *remoteHost, unsigned int remotePort, unsigned int localPort, unsigned int reqLength, TEthPktFlags *flags);</code>	TCP request handler.	Refer to the library example at the bottom of this page for code implementation.
<code>unsigned int SPI_Ethernet_UserUDP(unsigned char *remoteHost, unsigned int remotePort, unsigned int localPort, unsigned int reqLength, TEthPktFlags *flags);</code>	UDP request handler.	Refer to the library example at the bottom of this page for code implementation.

Library Routines

- SPI_Ethernet_Init
- SPI_Ethernet_Enable
- SPI_Ethernet_Disable
- SPI_Ethernet_doPacket
- SPI_Ethernet_putByte
- SPI_Ethernet_putBytes
- SPI_Ethernet_putString
- SPI_Ethernet_putConstString
- SPI_Ethernet_putConstBytes
- SPI_Ethernet_getByte
- SPI_Ethernet_getBytes
- SPI_Ethernet_UserTCP
- SPI_Ethernet_UserUDP
- SPI_Ethernet_getIpAddress
- SPI_Ethernet_getGwIpAddress
- SPI_Ethernet_getDnsIpAddress
- SPI_Ethernet_getIpMask
- SPI_Ethernet_confNetwork
- SPI_Ethernet_arpResolve
- SPI_Ethernet_sendUDP
- SPI_Ethernet_dnsResolve
- SPI_Ethernet_initDHCP
- SPI_Ethernet_doDHCPLeaseTime
- SPI_Ethernet_renewDHCP

SPIx_Write

Prototype	<code>void SPI_Ethernet_Init(unsigned char *mac, unsigned char *ip, unsigned char fullDuplex);</code>
Description	<p>This is MAC module routine. It initializes ENC28J60 controller. This function is internally splitted into 2 parts to help linker when coming short of memory.</p> <p>ENC28J60 controller settings (parameters not mentioned here are set to default):</p> <ul style="list-style-type: none"> - receive buffer start address : 0x0000. - receive buffer end address : 0x19AD. - transmit buffer start address: 0x19AE. - transmit buffer end address : 0x1FFF. - RAM buffer read/write pointers in auto-increment mode. - receive filters set to default: CRC + MAC Unicast + MAC Broadcast in OR mode. - flow control with TX and RX pause frames in full duplex mode. - frames are padded to 60 bytes + CRC. - maximum packet size is set to 1518. - Back-to-Back Inter-Packet Gap: 0x15 in full duplex mode; 0x12 in half duplex mode. - Non-Back-to-Back Inter-Packet Gap: 0x0012 in full duplex mode; 0x0C12 in half duplex mode. - Collision window is set to 63 in half duplex mode to accomodate some ENC28J60 revisions silicon bugs. - CLKOUT output is disabled to reduce EMI generation. - half duplex loopback disabled. - LED configuration: default (LEDA-link status, LEDB-link activity).

SPIx_Write

Parameters	<ul style="list-style-type: none"> - <code>mac</code>: RAM buffer containing valid MAC address. - <code>ip</code>: RAM buffer containing valid IP address. - <code>fullDuplex</code>: ethernet duplex mode switch. Valid values: <code>0</code> (half duplex mode) and <code>1</code> (full duplex mode).
Returns	Received data.
Requires	<p>Global variables :</p> <ul style="list-style-type: none"> - <code>SPI_Ethernet_CS</code>: Chip Select line - <code>SPI_Ethernet_CS_Direction</code>: Direction of the Chip Select pin - <code>SPI_Ethernet_RST</code>: Reset line - <code>SPI_Ethernet_RST_Direction</code>: Direction of the Reset pin <p>must be defined before using this function.</p> <p>The SPI module needs to be initialized. See the <code>SPIx_Init</code> and <code>SPIx_Init_Advanced</code> routines.</p>
Example	<pre> #define SPI_Ethernet_HALFDUPLEX 0 #define SPI_Ethernet_FULLDUPLEX 1 // mE ethernet NIC pinout sfr sbit SPI_Ethernet_Rst at RF0_bit; sfr sbit SPI_Ethernet_CS at RF1_bit; sfr sbit SPI_Ethernet_Rst_Direction at TRISF0_bit; sfr sbit SPI_Ethernet_CS_Direction at TRISF1_bit; // end ethernet NIC definitions unsigned char myMacAddr[6] = {0x00, 0x14, 0xA5, 0x76, 0x19, 0x3f}; // my MAC address unsigned char myIpAddr = {192, 168, 1, 60 }; // my IP addr SPI1_Init(); SPI_Ethernet_Init(myMacAddr, myIpAddr, SPI_Ethernet_FULLDUPLEX); </pre>
Notes	None.

SPI_Ethernet_Enable

Prototype	<code>void SPI_Ethernet_Enable(unsigned char enFlt);</code>																																				
Description	<p>This is MAC module routine. This routine enables appropriate network traffic on the ENC28J60 module by the means of it's receive filters (unicast, multicast, broadcast, crc). Specific type of network traffic will be enabled if a corresponding bit of this routine's input parameter is set. Therefore, more than one type of network traffic can be enabled at the same time. For this purpose, predefined library constants (see the table below) can be ORed to form appropriate input value.</p> <p>Advanced filtering available in the ENC28J60 module such as <i>Pattern Match</i>, <i>Magic Packet</i> and <i>Hash Table</i> can not be enabled by this routine. Additionally, all filters, except CRC, enabled with this routine will work in OR mode, which means that packet will be received if any of the enabled filters accepts it.</p> <p>This routine will change receive filter configuration on-the-fly. It will not, in any way, mess with enabling/disabling receive/transmit logic or any other part of the ENC28J60 module. The ENC28J60 module should be properly configured by the means of SPI_Ethernet_Init routine.</p>																																				
Parameters	<p>- <i>enFlt</i>: network traffic/receive filter flags. Each bit corresponds to the appropriate network traffic/receive filter:</p> <table border="1"> <thead> <tr> <th>Bit</th> <th>Mask</th> <th>Description</th> <th>Predefined library const</th> </tr> </thead> <tbody> <tr> <td>0</td> <td>0x01</td> <td>MAC Broadcast traffic/receive filter flag. When set, MAC broadcast traffic will be enabled.</td> <td><code>_SPI_Ethernet_BROADCAST</code></td> </tr> <tr> <td>1</td> <td>0x02</td> <td>MAC Multicast traffic/receive filter flag. When set, MAC multicast traffic will be enabled.</td> <td><code>_SPI_Ethernet_MULTICAST</code></td> </tr> <tr> <td>2</td> <td>0x04</td> <td>not used</td> <td>none</td> </tr> <tr> <td>3</td> <td>0x08</td> <td>not used</td> <td>none</td> </tr> <tr> <td>4</td> <td>0x10</td> <td>not used</td> <td>none</td> </tr> <tr> <td>5</td> <td>0x20</td> <td>CRC check flag. When set, packets with invalid CRC field will be discarded.</td> <td><code>_SPI_Ethernet_CRC</code></td> </tr> <tr> <td>6</td> <td>0x40</td> <td>not used</td> <td>none</td> </tr> <tr> <td>7</td> <td>0x80</td> <td>MAC Unicast traffic/receive filter flag. When set, MAC unicast traffic will be enabled.</td> <td><code>_SPI_Ethernet_UNICAST</code></td> </tr> </tbody> </table>	Bit	Mask	Description	Predefined library const	0	0x01	MAC Broadcast traffic/receive filter flag. When set, MAC broadcast traffic will be enabled.	<code>_SPI_Ethernet_BROADCAST</code>	1	0x02	MAC Multicast traffic/receive filter flag. When set, MAC multicast traffic will be enabled.	<code>_SPI_Ethernet_MULTICAST</code>	2	0x04	not used	none	3	0x08	not used	none	4	0x10	not used	none	5	0x20	CRC check flag. When set, packets with invalid CRC field will be discarded.	<code>_SPI_Ethernet_CRC</code>	6	0x40	not used	none	7	0x80	MAC Unicast traffic/receive filter flag. When set, MAC unicast traffic will be enabled.	<code>_SPI_Ethernet_UNICAST</code>
Bit	Mask	Description	Predefined library const																																		
0	0x01	MAC Broadcast traffic/receive filter flag. When set, MAC broadcast traffic will be enabled.	<code>_SPI_Ethernet_BROADCAST</code>																																		
1	0x02	MAC Multicast traffic/receive filter flag. When set, MAC multicast traffic will be enabled.	<code>_SPI_Ethernet_MULTICAST</code>																																		
2	0x04	not used	none																																		
3	0x08	not used	none																																		
4	0x10	not used	none																																		
5	0x20	CRC check flag. When set, packets with invalid CRC field will be discarded.	<code>_SPI_Ethernet_CRC</code>																																		
6	0x40	not used	none																																		
7	0x80	MAC Unicast traffic/receive filter flag. When set, MAC unicast traffic will be enabled.	<code>_SPI_Ethernet_UNICAST</code>																																		
Returns	Nothing.																																				
Requires	Ethernet module has to be initialized. See SPI_Ethernet_Init.																																				
Example	<code>SPI_Ethernet_Enable(_SPI_Ethernet_CRC _SPI_Ethernet_UNICAST); // enable CRC checking and Unicast traffic</code>																																				
Notes	<p>Advanced filtering available in the ENC28J60 module such as <i>Pattern Match</i>, <i>Magic Packet</i> and <i>Hash Table</i> can not be enabled by this routine. Additionally, all filters, except CRC, enabled with this routine will work in OR mode, which means that packet will be received if any of the enabled filters accepts it.</p> <p>This routine will change receive filter configuration on-the-fly. It will not, in any way, mess with enabling/disabling receive/transmit logic or any other part of the ENC28J60 module. The ENC28J60 module should be properly configured by the means of SPI_Ethernet_Init routine.</p>																																				

SPI_Ethernet_Disable

Prototype	<code>void SPI_Ethernet_Disable(unsigned char disFlt);</code>		
Description	This is MAC module routine. This routine disables appropriate network traffic on the ENC28J60 module by the means of it's receive filters (unicast, multicast, broadcast, crc). Specific type of network traffic will be disabled if a corresponding bit of this routine's input parameter is set. Therefore, more than one type of network traffic can be disabled at the same time. For this purpose, predefined library constants (see the table below) can be ORed to form appropriate input value.		
Parameters	- <code>disFlt</code> : network traffic/receive filter flags. Each bit corresponds to the appropriate network traffic/receive filter:		
	Bit	Mask	Description
	0	0x01	MAC Broadcast traffic/receive filter flag. When set, MAC broadcast traffic will be disabled.
	1	0x02	MAC Multicast traffic/receive filter flag. When set, MAC multicast traffic will be disabled.
	2	0x04	not used
	3	0x08	not used
	4	0x10	not used
	5	0x20	CRC check flag. When set, CRC check will be disabled and packets with invalid CRC field will be accepted.
	6	0x40	not used
	7	0x80	MAC Unicast traffic/receive filter flag. When set, MAC unicast traffic will be disabled.
			Predefined library const
			<code>_SPI_Ethernet_BROADCAST</code>
			<code>_SPI_Ethernet_MULTICAST</code>
			none
			none
			none
			<code>_SPI_Ethernet_CRC</code>
			none
			<code>_SPI_Ethernet_UNICAST</code>
Returns	Nothing.		
Requires	Ethernet module has to be initialized. See <code>SPI_Ethernet_Init</code> .		
Example	<code>SPI_Ethernet_Disable(_SPI_Ethernet_CRC _SPI_Ethernet_UNICAST); // disable CRC checking and Unicast traffic</code>		
Notes	Advanced filtering available in the ENC28J60 module such as <code>Pattern Match</code> , <code>Magic Packet</code> and <code>Hash Table</code> can not be disabled by this routine. This routine will change receive filter configuration on-the-fly. It will not, in any way, mess with enabling/disabling receive/transmit logic or any other part of the ENC28J60 module. The ENC28J60 module should be properly configured by the means of <code>SPI_Ethernet_Init</code> routine.		

SPI_Ethernet_doPacket

Prototype	<code>unsigned int SPI_Ethernet_doPacket();</code>
Description	<p>This is MAC module routine. It processes next received packet if such exists. Packets are processed in the following manner:</p> <ul style="list-style-type: none"> - ARP & ICMP requests are replied automatically. - upon TCP request the SPI_Ethernet_UserTCP function is called for further processing. - upon UDP request the SPI_Ethernet_UserUDP function is called for further processing.
Parameters	None.
Returns	<ul style="list-style-type: none"> - 0 - upon successful packet processing (zero packets received or received packet processed successfully). - 1 - upon reception error or receive buffer corruption. ENC28J60 controller needs to be restarted. - 2 - received packet was not sent to us (not our IP, nor IP broadcast address). - 3 - received IP packet was not IPv4. - 4 - received packet was of type unknown to the library.
Requires	Ethernet module has to be initialized. See SPI_Ethernet_Init.
Example	<pre>if (SPI_Ethernet_doPacket() == 0) (1) { // process received packets ... }</pre>
Notes	SPI_Ethernet_doPacket must be called as often as possible in user's code.

SPI_Ethernet_putByte

Prototype	<code>void SPI_Ethernet_putByte(unsigned char v);</code>
Description	This is MAC module routine. It stores one byte to address pointed by the current ENC28J60 write pointer (EWRPT).
Parameters	- v: value to store
Returns	Nothing.
Requires	Ethernet module has to be initialized. See SPI_Ethernet_Init.
Example	<pre>char data_; ... SPI_Ethernet_putByte(data); // put an byte into ENC28J60 buffer</pre>
Notes	None.

SPI_Ethernet_putBytes

Prototype	<code>void SPI_Ethernet_putBytes(unsigned char *ptr, unsigned int n);</code>
Description	This is MAC module routine. It stores requested number of bytes into ENC28J60 RAM starting from current ENC28J60 write pointer (EWRPT) location.
Parameters	- <code>ptr</code> : RAM buffer containing bytes to be written into ENC28J60 RAM. - <code>n</code> : number of bytes to be written.
Returns	Nothing.
Requires	Ethernet module has to be initialized. See SPI_Ethernet_Init.
Example	<pre>char *buffer = "mikroElektronika"; ... SPI_Ethernet_putBytes(buffer, 16); // put an RAM array into ENC28J60 buffer</pre>
Notes	None.

SPI_Ethernet_putConstBytes

Prototype	<code>void SPI_Ethernet_putConstBytes(const unsigned char *ptr, unsigned int n);</code>
Description	This is MAC module routine. It stores requested number of const bytes into ENC28J60 RAM starting from current ENC28J60 write pointer (EWRPT) location.
Parameters	- <code>ptr</code> : const buffer containing bytes to be written into ENC28J60 RAM. - <code>n</code> : number of bytes to be written.
Returns	Nothing.
Requires	Ethernet module has to be initialized. See SPI_Ethernet_Init.
Example	<pre>const char *buffer = "mikroElektronika"; ... SPI_Ethernet_putConstBytes(buffer, 16); // put a const array into ENC28J60 buffer</pre>
Notes	None.

SPI_Ethernet_putString

Prototype	<code>unsigned int SPI_Ethernet_putString(unsigned char *ptr);</code>
Description	This is MAC module routine. It stores whole string (excluding null termination) into ENC28J60 RAM starting from current ENC28J60 write pointer (EWRPT) location.
Parameters	- <code>ptr</code> : string to be written into ENC28J60 RAM.
Returns	Number of bytes written into ENC28J60 RAM.
Requires	Ethernet module has to be initialized. See SPI_Ethernet_Init.
Example	<pre>char *buffer = "mikroElektronika"; ... SPI_Ethernet_putString(buffer); // put a RAM string into ENC28J60 buffer</pre>
Notes	None.

SPI_Ethernet_putConstString

Prototype	<code>unsigned int SPI_Ethernet_putConstString(const unsigned char *ptr);</code>
Description	This is MAC module routine. It stores whole const string (excluding null termination) into ENC28J60 RAM starting from current ENC28J60 write pointer (EWRPT) location.
Parameters	- <code>ptr</code> : const string to be written into ENC28J60 RAM.
Returns	Number of bytes written into ENC28J60 RAM.
Requires	Ethernet module has to be initialized. See SPI_Ethernet_Init.
Example	<pre>const char *buffer = "mikroElektronika"; ... SPI_Ethernet_putConstString(buffer); // put a const string into ENC28J60 buffer</pre>
Notes	None.

SPI_Ethernet_getByte

Prototype	<code>unsigned char SPI_Ethernet_getByte();</code>
Description	This is MAC module routine. It fetches a byte from address pointed to by current ENC28J60 read pointer (ERDPT).
Parameters	None.
Returns	Byte read from ENC28J60 RAM.
Requires	Ethernet module has to be initialized. See SPI_Ethernet_Init.
Example	<pre>char buffer; ... buffer = SPI_Ethernet_getByte(); // read a byte from ENC28J60 buffer</pre>
Notes	None.

SPI_Ethernet_getBytes

Prototype	<code>void SPI_Ethernet_getBytes(unsigned char *ptr, unsigned int addr, unsigned int n);</code>
Description	This is MAC module routine. It fetches requested number of bytes from ENC28J60 RAM starting from given address. If value of 0xFFFF is passed as the address parameter, the reading will start from current ENC28J60 read pointer (ERDPT) location.
Parameters	- <code>ptr</code> : buffer for storing bytes read from ENC28J60 RAM. - <code>addr</code> : ENC28J60 RAM start address. Valid values: 0..8192. - <code>n</code> : number of bytes to be read.
Returns	Nothing.
Requires	Ethernet module has to be initialized. See SPI_Ethernet_Init.
Example	<pre>char buffer[16]; ... SPI_Ethernet_getBytes(buffer, 0x100, 16); // read 16 bytes, starting from address 0x100</pre>
Notes	None.

SPI_Ethernet_UserTCP

Prototype	<code>unsigned int SPI_Ethernet_UserTCP(unsigned char *remoteHost, unsigned int remotePort, unsigned int localPort, unsigned int reqLength, TEthPktFlags *flags);</code>
Description	This is TCP module routine. It is internally called by the library. The user accesses to the TCP request by using some of the SPI_Ethernet_get routines. The user puts data in the transmit buffer by using some of the SPI_Ethernet_put routines. The function must return the length in bytes of the TCP reply, or 0 if there is nothing to transmit. If there is no need to reply to the TCP requests, just define this function with return(0) as a single statement.
Parameters	<ul style="list-style-type: none"> - remoteHost: client's IP address. - remotePort: client's TCP port. - localPort: port to which the request is sent. - reqLength: TCP request data field length. - flags: structure consisted of two bit fields : <p>Copy Code To Clipboard</p> <pre>typedef struct { unsigned canCloseTCP: 1; // flag which closes socket unsigned isBroadcast: 1; // flag which denotes that the IP package has been received via subnet broadcast address } TEthPktFlags;</pre>
Returns	<ul style="list-style-type: none"> - 0 - there should not be a reply to the request. - Length of TCP reply data field - otherwise.
Requires	Ethernet module has to be initialized. See SPI_Ethernet_Init.
Example	This function is internally called by the library and should not be called by the user's code.
Notes	The function source code is provided with appropriate example projects. The code should be adjusted by the user to achieve desired reply.

SPI_Ethernet_UserUDP

Prototype	<code>unsigned int SPI_Ethernet_UserUDP(unsigned char *remoteHost, unsigned int remotePort, unsigned int localPort, unsigned int reqLength, TEthPktFlags *flags);</code>
Description	This is UDP module routine. It is internally called by the library. The user accesses to the UDP request by using some of the SPI_Ethernet_get routines. The user puts data in the transmit buffer by using some of the SPI_Ethernet_put routines. The function must return the length in bytes of the UDP reply, or 0 if nothing to transmit. If you don't need to reply to the UDP requests, just define this function with a return(0) as single statement.
Parameters	<ul style="list-style-type: none"> - <code>remoteHost</code>: client's IP address. - <code>remotePort</code>: client's port. - <code>localPort</code>: port to which the request is sent. - <code>reqLength</code>: UDP request data field length. - <code>flags</code>: structure consisted of two bit fields : <p>Copy Code To Clipboard</p> <pre>typedef struct { unsigned canCloseTCP: 1; // flag which closes TCP socket (not relevant to UDP) unsigned isBroadcast: 1; // flag which denotes that the IP package has been received via subnet broadcast address } TEthPktFlags;</pre>
Returns	<ul style="list-style-type: none"> - 0 - there should not be a reply to the request. - Length of UDP reply data field - otherwise.
Requires	Ethernet module has to be initialized. See SPI_Ethernet_Init.
Example	This function is internally called by the library and should not be called by the user's code.
Notes	The function source code is provided with appropriate example projects. The code should be adjusted by the user to achieve desired reply.

SPI_Ethernet_getIpAddress

Prototype	<code>unsigned char * SPI_Ethernet_getIpAddress();</code>
Description	This routine should be used when DHCP server is present on the network to fetch assigned IP address.
Parameters	None.
Returns	Pointer to the global variable holding IP address.
Requires	Ethernet module has to be initialized. See SPI_Ethernet_Init.
Example	<pre>unsigned char ipAddr[4]; // user IP address buffer ... memcpy(ipAddr, SPI_Ethernet_getIpAddress(), 4); // fetch IP address</pre>
Notes	User should always copy the IP address from the RAM location returned by this routine into it's own IP address buffer. These locations should not be altered by the user in any case!

SPI_Ethernet_getDnsIpAddress

Prototype	<code>unsigned char * SPI_Ethernet_getDnsIpAddress();</code>
Description	This routine should be used when DHCP server is present on the network to fetch assigned DNS IP address.
Parameters	None.
Returns	Pointer to the global variable holding DNS IP address.
Requires	Ethernet module has to be initialized. See SPI_Ethernet_Init.
Example	<pre>unsigned char dnsIpAddr[4]; // user DNS IP address buffer ... memcpy(dnsIpAddr, SPI_Ethernet_getDnsIpAddress(), 4); // fetch DNS server address</pre>
Notes	User should always copy the IP address from the RAM location returned by this routine into it's own DNS IP address buffer. These locations should not be altered by the user in any case!

SPI_Ethernet_getIpMask

Prototype	<code>unsigned char * SPI_Ethernet_getIpMask();</code>
Description	This routine should be used when DHCP server is present on the network to fetch assigned IP subnet mask.
Parameters	None.
Returns	Pointer to the global variable holding IP subnet mask.
Requires	Ethernet module has to be initialized. See SPI_Ethernet_Init.
Example	<pre>unsigned char IpMask[4]; // user IP subnet mask buffer ... memcpy(IpMask, SPI_Ethernet_getIpMask(), 4); // fetch IP subnet mask</pre>
Notes	User should always copy the IP address from the RAM location returned by this routine into it's own IP subnet mask buffer. These locations should not be altered by the user in any case!

SPI_Ethernet_confNetwork

Prototype	<code>void SPI_Ethernet_confNetwork(char *ipMask, char *gwIpAddr, char *dnsIpAddr);</code>
Description	Configures network parameters (IP subnet mask, gateway IP address, DNS IP address) when DHCP is not used.
Parameters	- <code>ipMask</code> : IP subnet mask. - <code>gwIpAddr</code> : gateway IP address. - <code>dnsIpAddr</code> : DNS IP address.
Returns	Nothing.
Requires	Ethernet module has to be initialized. See <code>SPI_Ethernet_Init</code> .
Example	<pre>char ipMask[4] = {255, 255, 255, 0}; // network mask (for example : 255.255.255.0) char gwIpAddr[4] = {192, 168, 1, 1}; // gateway (router) IP address char dnsIpAddr[4] = {192, 168, 1, 1}; // DNS server IP address ... SPI_Ethernet_confNetwork(ipMask, gwIpAddr, dnsIpAddr); // set network configuration parameters</pre>
Notes	The above mentioned network parameters should be set by this routine only if DHCP module is not used. Otherwise DHCP will override these settings.

SPI_Ethernet_arpResolve

Prototype	<code>unsigned char *SPI_Ethernet_arpResolve(unsigned char *ip, unsigned char tmax);</code>
Description	This is ARP module routine. It sends an ARP request for given IP address and waits for ARP reply. If the requested IP address was resolved, an ARP cache entry is used for storing the configuration. ARP cache can store up to 3 entries. For ARP cache structure refer to "eth_enc28j60LibDef.h" header file in the compiler's Uses folder.
Parameters	- <code>ip</code> : IP address to be resolved. - <code>tmax</code> : time in seconds to wait for a reply.
Returns	- MAC address behind the IP address - the requested IP address was resolved. - 0 - otherwise.
Requires	Ethernet module has to be initialized. See <code>SPI_Ethernet_Init</code> .
Example	<pre>unsigned char IpAddr[4] = {192, 168, 1, 1}; // IP address ... SPI_Ethernet_arpResolve(IpAddr, 5); // get MAC address behind the above IP address, wait 5 secs for the response</pre>
Notes	The Ethernet services are not stopped while this routine waits for ARP reply. The incoming packets will be processed normally during this time.

SPI_Ethernet_sendUDP

Prototype	<code>unsigned int SPI_Ethernet_sendUDP(unsigned char *destIP, unsigned int sourcePort, unsigned int destPort, unsigned char *pkt, unsigned int pktLen);</code>
Description	This is UDP module routine. It sends an UDP packet on the network.
Parameters	<ul style="list-style-type: none"> - <code>destIP</code>: remote host IP address. - <code>sourcePort</code>: local UDP source port number. - <code>destPort</code>: destination UDP port number. - <code>pkt</code>: packet to transmit. - <code>pktLen</code>: length in bytes of packet to transmit.
Returns	<ul style="list-style-type: none"> - 1 - UDP packet was sent successfully. - 0 - otherwise.
Requires	Ethernet module has to be initialized. See SPI_Ethernet_Init.
Example	<pre>unsigned char IpAddr[4] = {192, 168, 1, 1}; // remote IP address ... SPI_Ethernet_sendUDP(IpAddr, 10001, 10001, "Hello", 5); // send Hello message to the above IP address, from UDP port 10001 to UDP port 10001</pre>
Notes	None.

SPI_Ethernet_dnsResolve

Prototype	<code>unsigned char * SPI_Ethernet_dnsResolve(unsigned char *host, unsigned char tmax);</code>
Description	This is DNS module routine. It sends an DNS request for given host name and waits for DNS reply. If the requested host name was resolved, it's IP address is stored in library global variable and a pointer containing this address is returned by the routine. UDP port 53 is used as DNS port.
Parameters	<ul style="list-style-type: none"> - <code>host</code>: host name to be resolved. - <code>tmax</code>: time in seconds to wait for an reply.
Returns	<ul style="list-style-type: none"> - pointer to the location holding the IP address - the requested host name was resolved. - 0 - otherwise.
Requires	Ethernet module has to be initialized. See SPI_Ethernet_Init.
Example	<pre>unsigned char * remoteHostIpAddr[4]; // user host IP address buffer ... // SNMP server: // Zurich, Switzerland: Integrated Systems Lab, Swiss Fed. Inst. of // Technology // 129.132.2.21: swisstime.ethz.ch // Service Area: Switzerland and Europe memcpy(remoteHostIpAddr, SPI_Ethernet_dnsResolve("swisstime.ethz.ch", 5), 4);</pre>
Notes	<p>The Ethernet services are not stopped while this routine waits for DNS reply. The incoming packets will be processed normally during this time.</p> <p>User should always copy the IP address from the RAM location returned by this routine into it's own resolved host IP address buffer. These locations should not be altered by the user in any case!</p>

SPI_Ethernet_initDHCP

Prototype	<code>unsigned int SPI_Ethernet_initDHCP(unsigned char tmax);</code>
Description	<p>This is DHCP module routine. It sends an DHCP request for network parameters (IP, gateway, DNS addresses and IP subnet mask) and waits for DHCP reply. If the requested parameters were obtained successfully, their values are stored into the library global variables.</p> <p>These parameters can be fetched by using appropriate library IP get routines:</p> <ul style="list-style-type: none"> - SPI_Ethernet_getIpAddress - fetch IP address. - SPI_Ethernet_getGwIpAddress - fetch gateway IP address. - SPI_Ethernet_getDnsIpAddress - fetch DNS IP address. - SPI_Ethernet_getIpMask - fetch IP subnet mask. <p>UDP port 68 is used as DHCP client port and UDP port 67 is used as DHCP server port.</p>
Parameters	- <code>tmax</code> : time in seconds to wait for an reply.
Returns	- 1 - network parameters were obtained successfully. - 0 - otherwise.
Requires	Ethernet module has to be initialized. See SPI_Ethernet_Init.
Example	<pre>... SPI_Ethernet_initDHCP(5); // get network configuration from DHCP server, wait 5 sec for the response ...</pre>
Notes	<p>The Ethernet services are not stopped while this routine waits for DNS reply. The incoming packets will be processed normally during this time.</p> <p>When DHCP module is used, global library variable <code>SPI_Ethernet_userTimerSec</code> is used to keep track of time. It is user responsibility to increment this variable each second in it's code.</p>

SPI_Ethernet_doDHCPLeaseTime

Prototype	<code>unsigned int SPI_Ethernet_doDHCPLeaseTime();</code>
Description	This is DHCP module routine. It takes care of IP address lease time by decrementing the global lease time library counter. When this time expires, it's time to contact DHCP server and renew the lease.
Parameters	None.
Returns	- 0 - lease time has not expired yet. - 1 - lease time has expired, it's time to renew it.
Requires	Ethernet module has to be initialized. See SPI_Ethernet_Init.
Example	<pre>while(1) { ... if (SPI_Ethernet_doDHCPLeaseTime()) ... // it's time to renew the IP address lease }</pre>
Notes	None.

SPI_Ethernet_renewDHCP

Prototype	<code>unsigned int SPI_Ethernet_renewDHCP(unsigned char tmax);</code>
Description	This is DHCP module routine. It sends IP address lease time renewal request to DHCP server.
Parameters	- <code>tmax</code> : time in seconds to wait for an reply.
Returns	- 1 - upon success (lease time was renewed). - 0 - otherwise (renewal request timed out).
Requires	Ethernet module has to be initialized. See SPI_Ethernet_Init.
Example	<pre>while(1) { ... if (SPI_Ethernet_doDHCPLeaseTime()) SPI_Ethernet_renewDHCP(5); // it's time to renew the IP address lease, with 5 secs for a reply ... }</pre>
Notes	None.

Library Example

This code shows how to use the Ethernet mini library :

- the board will reply to ARP & ICMP echo requests
- the board will reply to UDP requests on any port :
 - returns the request in upper char with a header made of remote host IP & port number
- the board will reply to HTTP requests on port 80, GET method with pathnames :
 - / will return the HTML main page
 - /s will return board status as text string
 - /t0 ... /t7 will toggle RD0 to RD7 bit and return HTML main page
 - all other requests return also HTML main page.

Copy Code To Clipboard

```
#include "__EthEnc28j60.h"

// duplex config flags
#define Spi_Ethernet_HALFDUPLEX      0x00 // half duplex
#define Spi_Ethernet_FULLLDUPLEX     0x01 // full duplex

// mE ethernet NIC pinout
sfr sbit SPI_Ethernet_Rst at LATF0_bit; // for writing to output pin always use latch
sfr sbit SPI_Ethernet_CS at LATF1_bit; // for writing to output pin always use latch
sfr sbit SPI_Ethernet_Rst_Direction at TRISF0_bit;
sfr sbit SPI_Ethernet_CS_Direction at TRISF1_bit;
// end ethernet NIC definitions

/*****
 * ROM constant strings
 */
const code unsigned char httpHeader[] = "HTTP/1.1 200 OK\nContent-type: "; // HTTP
header
const code unsigned char httpMimeTypeHTML[] = "text/html\n"; // HTML MIME
type
const code unsigned char httpMimeTypeScript[] = "text/plain\n"; // TEXT MIME
type
unsigned char httpMethod[] = "GET /";
/*
 * web page, splited into 2 parts :
 * when coming short of ROM, fragmented data is handled more efficiently by linker
 *
 * this HTML page calls the boards to get its status, and builds itself with
javascript
 */
const code char *indexPage = // Change the IP address of the page
to be refreshed
"<meta http-equiv='refresh' content='3;url=http://192.168.20.60'">
<HTML><HEAD></HEAD><BODY>
<h1>dsPIC + ENC28J60 Mini Web Server</h1>
```

```

<a href=/>Reload</a>
<script src=/s></script>
<table><tr><td valign=top><table border=1 style="font-size:20px ;font-family: terminal
; ">
<tr><th colspan=2>ADC</th></tr>
<tr><td>AN0</td><td><script>document.write(AN0)</script></td></tr>
<tr><td>AN1</td><td><script>document.write(AN1)</script></td></tr>
</table></td><td><table border=1 style="font-size:20px ;font-family: terminal ; ">
<tr><th colspan=2>PORTB</th></tr>
<script>
var str,i;
str="";
for(i=2;i<10;i++)
{str+="<tr><td bgcolor=pink>BUTTON #"+i+"</td>";
if(PORTB&(1<<i)) {str+="<td bgcolor=red>ON";}
else {str+="<td bgcolor=#cccccc>OFF";}
str+="</td></tr>";}
document.write(str) ;
</script>
" ;

const code char *indexPage2 = "</table></td><td>
<table border=1 style="font-size:20px ;font-family: terminal ; ">
<tr><th colspan=3>PORTD</th></tr>
<script>
var str,i;
str="";
for(i=0;i<4;i++)
{str+="<tr><td bgcolor=yellow>LED #"+i+"</td>";
if(PORTD&(1<<i)) {str+="<td bgcolor=red>ON";}
else {str+="<td bgcolor=#cccccc>OFF";}
str+="</td><td><a href=/t"+i+">Toggle</a></td></tr>";}
document.write(str) ;
</script>
</table></td></tr></table>
This is HTTP request #<script>document.write(REQ)</script></BODY></HTML>
" ;

/*****
* RAM variables
*/
unsigned char myMacAddr[6] = {0x00, 0x14, 0xA5, 0x76, 0x19, 0x3f}; // my MAC
address
unsigned char myIpAddr[4] = {192, 168, 20, 60 }; // my IP address
unsigned char gwIpAddr[4] = {192, 168, 20, 6 }; // gateway (router) IP address
unsigned char ipMask[4] = {255, 255, 255, 0 }; // network mask
(for example : 255.255.255.0)
unsigned char dnsIpAddr[4] = {192, 168, 20, 1 }; // DNS server IP address

unsigned char getRequest[15]; // HTTP request buffer
unsigned char dyna[31]; // buffer for dynamic response
unsigned long httpCounter = 0; // counter of HTTP requests

```

```
/******  
 * functions  
 */  
  
/*  
 * put the constant string pointed to by s to the ENC transmit buffer.  
 */  
/*unsigned int    putConstString(const code char *s)  
    {  
        unsigned int ctr = 0;  
  
        while(*s)  
        {  
            Spi_Ethernet_putByte(*s++);  
            ctr++;  
        }  
        return(ctr);  
    }*/  
  
/*  
 * it will be much faster to use library Spi_Ethernet_putConstString routine  
 * instead of putConstString routine above. However, the code will be a little  
 * bit bigger. User should choose between size and speed and pick the implementation  
that  
 * suites him best. If you choose to go with the putConstString definition above  
 * the #define line below should be commented out.  
 *  
 */  
#define putConstString    SPI_Ethernet_putConstString  
  
/*  
 * put the string pointed to by s to the ENC transmit buffer  
 */  
/*unsigned int    putString(char *s)  
    {  
        unsigned int ctr = 0;  
  
        while(*s)  
        {  
            Spi_Ethernet_putByte(*s++);  
  
            ctr++;  
        }  
        return(ctr);  
    }*/  
  
/*  
 * it will be much faster to use library Spi_Ethernet_putString routine  
 * instead of putString routine above. However, the code will be a little  
 * bit bigger. User should choose between size and speed and pick the implementation  
that  
 * suites him best. If you choose to go with the putString definition above  
 * the #define line below should be commented out.  
 *  
 */
```

```

#define putString  SPI_Ethernet_putString

/*
 * this function is called by the library
 * the user accesses to the HTTP request by successive calls to Spi_Ethernet_getByte()
 * the user puts data in the transmit buffer by successive calls to Spi_Ethernet_
putByte()
 * the function must return the length in bytes of the HTTP reply, or 0 if nothing to
transmit
 *
 * if you don't need to reply to HTTP requests,
 * just define this function with a return(0) as single statement
 *
 */
unsigned int  SPI_Ethernet_UserTCP(unsigned char *remoteHost, unsigned int remotePort,
unsigned int localPort, unsigned int reqLength, TEthPktFlags *flags)
{
    unsigned int    len;                // my reply length

    // should we close tcp socket after response is sent?
    // library closes tcp socket by default if canCloseTCP flag is not reset here
    // flags->canCloseTCP = 0; // 0 - do not close socket
    // otherwise - close socket

    if(localPort != 80)                // I listen only to web request on port 80
    {
        return(0);
    }

    // get 10 first bytes only of the request, the rest does not matter here
    for(len = 0; len < 10; len++)
    {
        getRequest[len] = SPI_Ethernet_getByte();
    }
    getRequest[len] = 0;
    len = 0;

    if(memcmp(getRequest, httpMethod, 5)) // only GET method is supported here
    {
        return(0);
    }

    httpCounter++;                    // one more request done

    if(getRequest[5] == 's')          // if request path name starts with s, store
dynamic data in transmit buffer
    {
        // the text string replied by this request can be interpreted as javascript
statements
        // by browsers

        len = putConstString(httpHeader); // HTTP header
        len += putConstString(httpMimeTypeScript); // with text MIME type
    }
}

```

```

// add AN0 value to reply
    WordToStr(ADC1_Get_Sample(0), dyna) ;
    len += putConstString("var AN0=") ;
    len += putString(dyna) ;
    len += putConstString(";") ;

    // add AN1 value to reply
    WordToStr(ADC1_Get_Sample(1), dyna) ;
    len += putConstString("var AN1=") ;
    len += putString(dyna) ;
    len += putConstString(";");

    // add PORTB value (buttons) to reply
    len += putConstString("var PORTB=");
    WordToStr(PORTB, dyna);
    len += putString(dyna);
    len += putConstString(";");

    // add PORTD value (LEDs) to reply
    len += putConstString("var PORTD=");
    WordToStr(PORTD, dyna);
    len += putString(dyna);
    len += putConstString(";");

    // add HTTP requests counter to reply
    WordToStr(httpCounter, dyna);
    len += putConstString("var REQ=");
    len += putString(dyna);
    len += putConstString(";");
}
else if(getRequest[5] == 't') // if request path name
starts with t, toggle PORTD (LED) bit number that comes after
{
    unsigned char    bitMask = 0; // for bit mask

    if(isdigit(getRequest[6])) // if 0 <= bit number <=
9, bits 8 & 9 does not exist but does not matter
    {
        bitMask = getRequest[6] - '0'; // convert ASCII to integer
        bitMask = 1 << bitMask; // create bit mask
        PORTD ^= bitMask; // toggle PORTD with xor operator
    }
}

if(len == 0) // what do to by default
{
    len = putConstString(httpHeader); // HTTP header
    len += putConstString(httpMimeTypeHTML); // with HTML MIME type
    len += putConstString(indexPage); // HTML page first part
    len += putConstString(indexPage2); // HTML page second part
}

return(len); // return to the library
with the number of bytes to transmit
}

```

```

/*
 * this function is called by the library
 * the user accesses to the UDP request by successive calls to Spi_Ethernet_getByte()
 * the user puts data in the transmit buffer by successive calls to Spi_Ethernet_
putByte()
 * the function must return the length in bytes of the UDP reply, or 0 if nothing to
transmit
 *
 * if you don't need to reply to UDP requests,
 * just define this function with a return(0) as single statement
 *
 */
unsigned int   SPI_Ethernet_UserUDP(unsigned char *remoteHost, unsigned int remotePort,
unsigned int destPort, unsigned int reqLength, TEthPktFlags *flags)
{
    unsigned int   len;                               // my reply length

    // reply is made of the remote host IP address in human readable format
    ByteToStr(remoteHost[0], dyna);                   // first IP address byte
    dyna[3] = '.';
    ByteToStr(remoteHost[1], dyna + 4);               // second
    dyna[7] = '.';
    ByteToStr(remoteHost[2], dyna + 8);               // third
    dyna[11] = '.';
    ByteToStr(remoteHost[3], dyna + 12);              // fourth

    dyna[15] = ':';                                   // add separator

    // then remote host port number
    WordToStr(remotePort, dyna + 16);
    dyna[21] = '[';
    WordToStr(destPort, dyna + 22);
    dyna[27] = ']';
    dyna[28] = 0;

    // the total length of the request is the length of the dynamic string plus the
text of the request
    len = 28 + reqLength;

    // puts the dynamic string into the transmit buffer
    SPI_Ethernet_putBytes(dyna, 28);

    // then puts the request string converted into upper char into the transmit
buffer
    while(reqLength--)
    {
        SPI_Ethernet_putByte(toupper(SPI_Ethernet_getByte()));
    }

    return(len);                                     // back to the library with the length of the UDP reply
}

```



```
/*
 * main entry
 */
void main()
{
    ADPCFG |= 0xFFFC;           // all digital but rb0(AN0) and rb1(AN1)

    PORTB = 0;
    TRISB = 0xFFFF;           // set PORTB as input for buttons and adc

    PORTD = 0;
    TRISD = 0;                 // set PORTD as output,

    ADC1_Init();               // Enable ADC module
    /*
     * starts ENC28J60 with :
     * reset bit on RC0
     * CS bit on RC1
     * my MAC & IP address
     * full duplex
     */
    // SPI1_Init();           // init SPI communication with ethernet board

    SPI1_Init_Advanced(_SPI_MASTER, _SPI_8_BIT, _SPI_PRESCALE_SEC_1, _SPI_PRESCALE_
PRI_4,
                      _SPI_SS_DISABLE, _SPI_DATA_SAMPLE_MIDDLE, _SPI_CLK_IDLE_LOW,
_SPI_IDLE_2_ACTIVE);

    SPI_Ethernet_Init(myMacAddr, myIpAddr, 1); // init ethernet board

    // dhcp will not be used here, so use preconfigured addresses
    SPI_Ethernet_confNetwork(ipMask, gwIpAddr, dnsIpAddr);

    while(1)                   // do forever
    {
        /*
         * if necessary, test the return value to get error code
         */
        SPI_Ethernet_doPacket(); // process incoming Ethernet packets

        /*
         * add your stuff here if needed
         * Spi_Ethernet_doPacket() must be called as often as possible
         * otherwise packets could be lost
         */
    }
}
```

HW Connection

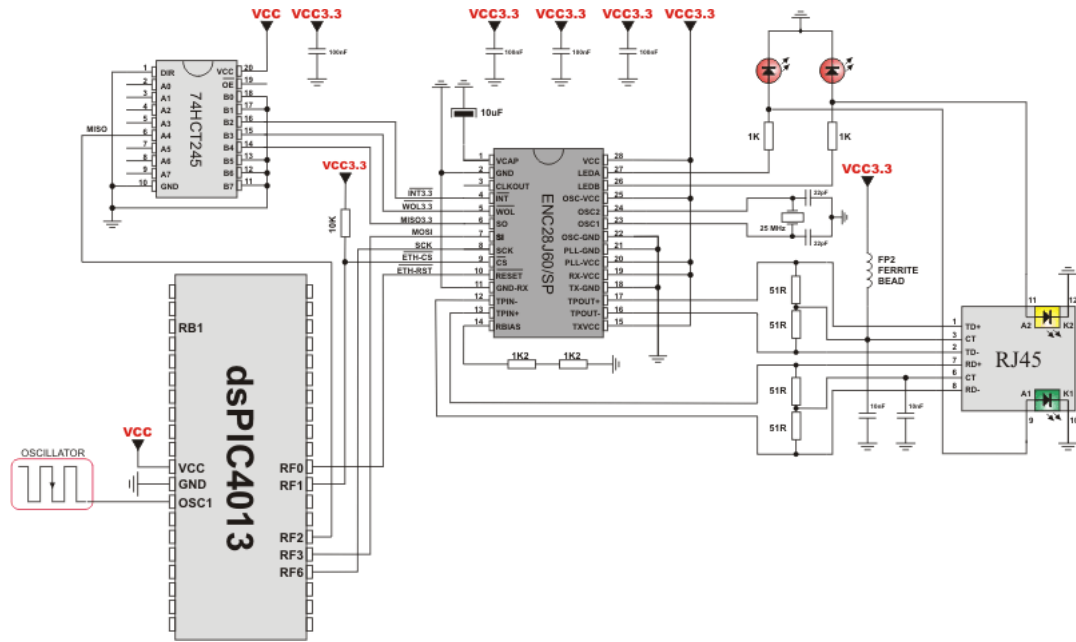

SPI Ethernet ENC24J600 Library

The `ENC24J600` is a stand-alone Ethernet controller with an industry standard Serial Peripheral Interface (SPI). It is designed to serve as an Ethernet network interface for any controller equipped with SPI.

The `ENC24J600` meets all of the IEEE 802.3 specifications applicable to 10Base-T and 100Base-TX Ethernet. It incorporates a number of packet filtering schemes to limit incoming packets. It also provides an internal, 16-bit wide DMA module for fast data throughput and hardware assisted IP checksum calculations. Communication with the host controller is implemented via two interrupt pins and the SPI, with data rates of 10/100 Mb/s. Two dedicated pins are used for LED link and network activity indication.

This library is designed to simplify handling of the underlying hardware (`ENC24J600`). It works with any dsPIC30/33 and PIC24 with integrated SPI and more than 4 Kb ROM memory. 38 to 40 MHz clock is recommended to get from 8 to 10 Mhz SPI clock, otherwise dsPIC30/33 and PIC24 should be clocked by ENC24J600 clock output due to its silicon bug in SPI hardware. If you try lower dsPIC30/33 and PIC24 clock speed, there might be board hang or miss some requests.

SPI Ethernet ENC24J600 library supports:

- IPv4 protocol.
- ARP requests.
- ICMP echo requests.
- UDP requests.
- TCP requests (no stack, no packet reconstruction).
- ARP client with cache.
- DNS client.
- UDP client.
- DHCP client.
- packet fragmentation is **NOT** supported.

Important :

- Global library variable `SPI_Ethernet_24j600_userTimerSec` is used to keep track of time for all client implementations (ARP, DNS, UDP and DHCP). It is user responsibility to increment this variable each second in it's code if any of the clients is used.
- For advanced users there are header files ("`__EthEnc24j600.h`" and "`__EthEnc24j600Private.h`") in Uses folder of the compiler with description of all routines and global variables, relevant to the user, implemented in the SPI Ethernet ENC24J600 Library.
- The appropriate hardware SPI module must be initialized before using any of the SPI Ethernet ENC24J600 library routines. Refer to SPI Library.
- For MCUs with multiple SPI modules it is possible to initialize them and then switch by using the `SPI_Set_Active()` routine.

Library Dependency Tree

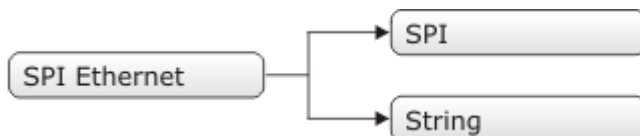

External dependencies of SPI Ethernet ENC24J600 Library

The following variables must be defined in all projects using SPI Ethernet ENC24J600 Library:	Description :	Example :
<pre>extern sfr sbit SPI_ Ethernet_24j600_CS;</pre>	ENC24J600 chip select pin.	<pre>sbit SPI_Ethernet_24j600_CS at LATF1_bit;</pre>
<pre>extern sfr sbit SPI_ Ethernet_24j600_CS_ Direction;</pre>	Direction of the ENC24J600 chip select pin.	<pre>sbit SPI_Ethernet_24j600_CS_ Direction at TRISF1_bit;</pre>

The following routines must be defined in all project using SPI Ethernet ENC24J600 Library:	Description :	Example :
<pre>unsigned int SPI_ Ethernet_24j600_ UserTCP(unsigned char *remoteHost, unsigned int remotePort, unsigned int localPort, unsigned int reqLength, TEthj600PktFlags *flags);</pre>	TCP request handler.	Refer to the library example at the bottom of this page for code implementation.
<pre>unsigned int SPI_ Ethernet_24j600_ UserUDP(unsigned char *remoteHost, unsigned int remotePort, unsigned int localPort, unsigned int reqLength, TEthj600PktFlags *flags);</pre>	UDP request handler.	Refer to the library example at the bottom of this page for code implementation.

Library Routines

- SPI_Ethernet_24j600_Init
- SPI_Ethernet_24j600_Enable
- SPI_Ethernet_24j600_Disable
- SPI_Ethernet_24j600_doPacket
- SPI_Ethernet_24j600_putByte
- SPI_Ethernet_24j600_putBytes
- SPI_Ethernet_24j600_putString
- SPI_Ethernet_24j600_putConstString
- SPI_Ethernet_24j600_putConstBytes
- SPI_Ethernet_24j600_getByte
- SPI_Ethernet_24j600_getBytes
- SPI_Ethernet_24j600_UserTCP
- SPI_Ethernet_24j600_UserUDP
- SPI_Ethernet_24j600_getIpAddress
- SPI_Ethernet_24j600_getGwIpAddress
- SPI_Ethernet_24j600_getDnsIpAddress
- SPI_Ethernet_24j600_getIpMask
- SPI_Ethernet_24j600_confNetwork
- SPI_Ethernet_24j600_arpResolve
- SPI_Ethernet_24j600_sendUDP
- SPI_Ethernet_24j600_dnsResolve
- SPI_Ethernet_24j600_initDHCP
- SPI_Ethernet_24j600_doDHCPLeaseTime
- SPI_Ethernet_24j600_renewDHCP

SPI_Ethernet_24j600_Init

Prototype	<code>void SPI_Ethernet_24j600_Init(unsigned char *mac, unsigned char *ip, unsigned char fullDuplex);</code>														
Description	<p>This is MAC module routine. It initializes ENC24J600 controller. This function is internally splitted into 2 parts to help linker when coming short of memory.</p> <p>ENC24J600 controller settings (parameters not mentioned here are set to default):</p> <ul style="list-style-type: none"> - receive buffer start address : 0x0000. - receive buffer end address : 0x19AD. - transmit buffer start address: 0x19AE. - transmit buffer end address : 0x1FFF. - RAM buffer read/write pointers in auto-increment mode. - receive filters set to default: CRC + MAC Unicast + MAC Broadcast in OR mode. - flow control with TX and RX pause frames in full duplex mode. - frames are padded to 60 bytes + CRC. - maximum packet size is set to 1518. - Back-to-Back Inter-Packet Gap: 0x15 in full duplex mode; 0x12 in half duplex mode. - Non-Back-to-Back Inter-Packet Gap: 0x0012 in full duplex mode; 0x0C12 in half duplex mode. - Collision window is set to 63 in half duplex mode to accomodate some ENC24J600 revisions silicon bugs. - CLKOUT output is disabled to reduce EMI generation. - half duplex loopback disabled. - LED configuration: default (LEDA-link status, LEDB-link activity). 														
Parameters	<ul style="list-style-type: none"> - <code>mac</code>: RAM buffer containing valid MAC address. - <code>ip</code>: RAM buffer containing valid IP address. - <code>configuration</code>: ethernet negotiation, duplex and speed mode settings. For this purpose, predefined library constants (see the list below) can be combined using logical AND to form appropriate value : <table border="1" data-bbox="239 970 1305 1272"> <thead> <tr> <th>Description :</th> <th>Predefined library const</th> </tr> </thead> <tbody> <tr> <td>Set Auto-negotiation</td> <td><code>SPI_Ethernet_24j600_AUTO_NEGOTIATION</code></td> </tr> <tr> <td>Set manual negotiation.</td> <td><code>SPI_Ethernet_24j600_MANUAL_NEGOTIATION</code></td> </tr> <tr> <td>Set Half duplex Mode</td> <td><code>SPI_Ethernet_24j600_HALFDUPLEX</code></td> </tr> <tr> <td>Set Full duplex Mode</td> <td><code>SPI_Ethernet_24j600_FULLDUPLEX</code></td> </tr> <tr> <td>Set transmission speed of 10Mbps</td> <td><code>SPI_Ethernet_24j600_SPD10</code></td> </tr> <tr> <td>Set transmission speed of 100Mbps</td> <td><code>SPI_Ethernet_24j600_SPD100</code></td> </tr> </tbody> </table> <p>Note :</p> <ul style="list-style-type: none"> - It is advisable to use only the Auto-negotiation setting. If manual negotiation is used, then duplex and speed mode setting must be set also. - Duplex and speed mode may be set only when using manual negotiation. 	Description :	Predefined library const	Set Auto-negotiation	<code>SPI_Ethernet_24j600_AUTO_NEGOTIATION</code>	Set manual negotiation.	<code>SPI_Ethernet_24j600_MANUAL_NEGOTIATION</code>	Set Half duplex Mode	<code>SPI_Ethernet_24j600_HALFDUPLEX</code>	Set Full duplex Mode	<code>SPI_Ethernet_24j600_FULLDUPLEX</code>	Set transmission speed of 10Mbps	<code>SPI_Ethernet_24j600_SPD10</code>	Set transmission speed of 100Mbps	<code>SPI_Ethernet_24j600_SPD100</code>
Description :	Predefined library const														
Set Auto-negotiation	<code>SPI_Ethernet_24j600_AUTO_NEGOTIATION</code>														
Set manual negotiation.	<code>SPI_Ethernet_24j600_MANUAL_NEGOTIATION</code>														
Set Half duplex Mode	<code>SPI_Ethernet_24j600_HALFDUPLEX</code>														
Set Full duplex Mode	<code>SPI_Ethernet_24j600_FULLDUPLEX</code>														
Set transmission speed of 10Mbps	<code>SPI_Ethernet_24j600_SPD10</code>														
Set transmission speed of 100Mbps	<code>SPI_Ethernet_24j600_SPD100</code>														

Returns	Nothing.
Requires	<p>Global variables :</p> <ul style="list-style-type: none"> - <code>SPI_Ethernet_24j600_CS</code>: Chip Select line - <code>SPI_Ethernet_24j600_CS_Direction</code>: Direction of the Chip Select pin <p>must be defined before using this function.</p> <p>The SPI module needs to be initialized. See the <code>SPIx_Init</code> and <code>SPIx_Init_Advanced</code> routines.</p>
Example	<pre>#include "_EthEnc24J600.h" // mE ethernet NIC pinout sfr sbit SPI_Ethernet_24j600_CS at RF1_bit; sfr sbit SPI_Ethernet_24j600_CS_Direction at TRISF1_bit; // end ethernet NIC definitions unsigned char myMacAddr[6] = {0x00, 0x14, 0xA5, 0x76, 0x19, 0x3f}; // my MAC address unsigned char myIpAddr = {192, 168, 1, 60 }; // my IP addr SPI1_Init(); SPI_Ethernet_24j600_Init(myMacAddr, myIpAddr, SPI_Ethernet_24j600_MANUAL_ NEGOTIATION & SPI_Ethernet_24j600_FULLDUPLEX & SPI_Ethernet_24j600_ SPD100);</pre>
Notes	None.

SPI_Ethernet_24j600_Enable

Prototype	<code>void SPI_Ethernet_24j600_Enable(unsigned int enFlt);</code>																																						
Description	<p>This is MAC module routine. This routine enables appropriate network traffic on the ENC24J600 module by the means of it's receive filters (unicast, multicast, broadcast, crc). Specific type of network traffic will be enabled if a corresponding bit of this routine's input parameter is set. Therefore, more than one type of network traffic can be enabled at the same time. For this purpose, predefined library constants (see the table below) can be ORed to form appropriate input value.</p> <p>Advanced filtering available in the ENC24J600 module such as Pattern Match, Magic Packet and Hash Table can not be enabled by this routine. Additionally, all filters, except CRC, enabled with this routine will work in OR mode, which means that packet will be received if any of the enabled filters accepts it.</p> <p>This routine will change receive filter configuration on-the-fly. It will not, in any way, mess with enabling/disabling receive/transmit logic or any other part of the ENC24J600 module. The ENC24J600 module should be properly configured by the means of SPI_Ethernet_24j600_Init routine.</p>																																						
Parameters	<p>- <code>enFlt</code>: network traffic/receive filter flags. Each bit corresponds to the appropriate network traffic/receive filter:</p> <table border="1"> <thead> <tr> <th>Bit</th> <th>Mask</th> <th>Description</th> <th>Predefined library const</th> </tr> </thead> <tbody> <tr> <td>0</td> <td>0x01</td> <td>MAC Broadcast traffic/receive filter flag. When set, MAC broadcast traffic will be enabled.</td> <td><code>_SPI_Ethernet_24j600_BROADCAST</code></td> </tr> <tr> <td>1</td> <td>0x02</td> <td>MAC Multicast traffic/receive filter flag. When set, MAC multicast traffic will be enabled.</td> <td><code>_SPI_Ethernet_24j600_MULTICAST</code></td> </tr> <tr> <td>2</td> <td>0x04</td> <td>not used</td> <td>none</td> </tr> <tr> <td>3</td> <td>0x08</td> <td>not used</td> <td>none</td> </tr> <tr> <td>4</td> <td>0x10</td> <td>not used</td> <td>none</td> </tr> <tr> <td>5</td> <td>0x20</td> <td>CRC check flag. When set, packets with invalid CRC field will be discarded.</td> <td><code>_SPI_Ethernet_24j600_CRC</code></td> </tr> <tr> <td>6</td> <td>0x40</td> <td>not used</td> <td>none</td> </tr> <tr> <td>7</td> <td>0x80</td> <td>MAC Unicast traffic/receive filter flag. When set, MAC unicast traffic will be enabled.</td> <td><code>_SPI_Ethernet_24j600_UNICAST</code></td> </tr> </tbody> </table>			Bit	Mask	Description	Predefined library const	0	0x01	MAC Broadcast traffic/receive filter flag. When set, MAC broadcast traffic will be enabled.	<code>_SPI_Ethernet_24j600_BROADCAST</code>	1	0x02	MAC Multicast traffic/receive filter flag. When set, MAC multicast traffic will be enabled.	<code>_SPI_Ethernet_24j600_MULTICAST</code>	2	0x04	not used	none	3	0x08	not used	none	4	0x10	not used	none	5	0x20	CRC check flag. When set, packets with invalid CRC field will be discarded.	<code>_SPI_Ethernet_24j600_CRC</code>	6	0x40	not used	none	7	0x80	MAC Unicast traffic/receive filter flag. When set, MAC unicast traffic will be enabled.	<code>_SPI_Ethernet_24j600_UNICAST</code>
Bit	Mask	Description	Predefined library const																																				
0	0x01	MAC Broadcast traffic/receive filter flag. When set, MAC broadcast traffic will be enabled.	<code>_SPI_Ethernet_24j600_BROADCAST</code>																																				
1	0x02	MAC Multicast traffic/receive filter flag. When set, MAC multicast traffic will be enabled.	<code>_SPI_Ethernet_24j600_MULTICAST</code>																																				
2	0x04	not used	none																																				
3	0x08	not used	none																																				
4	0x10	not used	none																																				
5	0x20	CRC check flag. When set, packets with invalid CRC field will be discarded.	<code>_SPI_Ethernet_24j600_CRC</code>																																				
6	0x40	not used	none																																				
7	0x80	MAC Unicast traffic/receive filter flag. When set, MAC unicast traffic will be enabled.	<code>_SPI_Ethernet_24j600_UNICAST</code>																																				
Returns	Nothing.																																						
Requires	Ethernet module has to be initialized. See SPI_Ethernet_24j600_Init.																																						
Example	<code>SPI_Ethernet_24j600_Enable(_SPI_Ethernet_24j600_CRC _SPI_Ethernet_24j600_UNICAST); // enable CRC checking and Unicast traffic</code>																																						
Notes	<p>Advanced filtering available in the ENC24J600 module such as Pattern Match, Magic Packet and Hash Table can not be enabled by this routine. Additionally, all filters, except CRC, enabled with this routine will work in OR mode, which means that packet will be received if any of the enabled filters accepts it.</p> <p>This routine will change receive filter configuration on-the-fly. It will not, in any way, mess with enabling/disabling receive/transmit logic or any other part of the ENC24J600 module. The ENC24J600 module should be properly configured by the means of SPI_Ethernet_24j600_Init routine.</p>																																						

Prototype	<code>void SPI_Ethernet_24j600_Disable(unsigned int disFlt);</code>																																				
Description	This is MAC module routine. This routine disables appropriate network traffic on the ENC24J600 module by the means of its receive filters (unicast, multicast, broadcast, crc). Specific type of network traffic will be disabled if a corresponding bit of this routine's input parameter is set. Therefore, more than one type of network traffic can be disabled at the same time. For this purpose, predefined library constants (see the table below) can be ORed to form appropriate input value.																																				
Parameters	<p>- <code>disFlt</code>: network traffic/receive filter flags. Each bit corresponds to the appropriate network traffic/receive filter:</p> <table border="1"> <thead> <tr> <th>Bit</th> <th>Mask</th> <th>Description</th> <th>Predefined library const</th> </tr> </thead> <tbody> <tr> <td>0</td> <td>0x01</td> <td>MAC Broadcast traffic/receive filter flag. When set, MAC broadcast traffic will be disabled.</td> <td><code>_SPI_Ethernet_24j600_BROADCAST</code></td> </tr> <tr> <td>1</td> <td>0x02</td> <td>MAC Multicast traffic/receive filter flag. When set, MAC multicast traffic will be disabled.</td> <td><code>_SPI_Ethernet_24j600_MULTICAST</code></td> </tr> <tr> <td>2</td> <td>0x04</td> <td>not used</td> <td>none</td> </tr> <tr> <td>3</td> <td>0x08</td> <td>not used</td> <td>none</td> </tr> <tr> <td>4</td> <td>0x10</td> <td>not used</td> <td>none</td> </tr> <tr> <td>5</td> <td>0x20</td> <td>CRC check flag. When set, CRC check will be disabled and packets with invalid CRC field will be accepted.</td> <td><code>_SPI_Ethernet_24j600_CRC</code></td> </tr> <tr> <td>6</td> <td>0x40</td> <td>not used</td> <td>none</td> </tr> <tr> <td>7</td> <td>0x80</td> <td>MAC Unicast traffic/receive filter flag. When set, MAC unicast traffic will be disabled.</td> <td><code>_SPI_Ethernet_24j600_UNICAST</code></td> </tr> </tbody> </table>	Bit	Mask	Description	Predefined library const	0	0x01	MAC Broadcast traffic/receive filter flag. When set, MAC broadcast traffic will be disabled.	<code>_SPI_Ethernet_24j600_BROADCAST</code>	1	0x02	MAC Multicast traffic/receive filter flag. When set, MAC multicast traffic will be disabled.	<code>_SPI_Ethernet_24j600_MULTICAST</code>	2	0x04	not used	none	3	0x08	not used	none	4	0x10	not used	none	5	0x20	CRC check flag. When set, CRC check will be disabled and packets with invalid CRC field will be accepted.	<code>_SPI_Ethernet_24j600_CRC</code>	6	0x40	not used	none	7	0x80	MAC Unicast traffic/receive filter flag. When set, MAC unicast traffic will be disabled.	<code>_SPI_Ethernet_24j600_UNICAST</code>
Bit	Mask	Description	Predefined library const																																		
0	0x01	MAC Broadcast traffic/receive filter flag. When set, MAC broadcast traffic will be disabled.	<code>_SPI_Ethernet_24j600_BROADCAST</code>																																		
1	0x02	MAC Multicast traffic/receive filter flag. When set, MAC multicast traffic will be disabled.	<code>_SPI_Ethernet_24j600_MULTICAST</code>																																		
2	0x04	not used	none																																		
3	0x08	not used	none																																		
4	0x10	not used	none																																		
5	0x20	CRC check flag. When set, CRC check will be disabled and packets with invalid CRC field will be accepted.	<code>_SPI_Ethernet_24j600_CRC</code>																																		
6	0x40	not used	none																																		
7	0x80	MAC Unicast traffic/receive filter flag. When set, MAC unicast traffic will be disabled.	<code>_SPI_Ethernet_24j600_UNICAST</code>																																		
Returns	Nothing.																																				
Requires	Ethernet module has to be initialized. See <code>SPI_Ethernet_24j600_Init</code> .																																				
Example	<code>SPI_Ethernet_24j600_Disable(_SPI_Ethernet_24j600_CRC _SPI_Ethernet_24j600_UNICAST); // disable CRC checking and Unicast traffic</code>																																				
Notes	<ul style="list-style-type: none"> - Advanced filtering available in the ENC24J600 module such as <code>Pattern Match</code>, <code>Magic Packet</code> and <code>Hash Table</code> can not be disabled by this routine. - This routine will change receive filter configuration on-the-fly. It will not, in any way, mess with enabling/disabling receive/transmit logic or any other part of the ENC24J600 module. - The ENC24J600 module should be properly configured by the means of <code>SPI_Ethernet_24j600_Init</code> routine. 																																				

SPI_Ethernet_24j600_doPacket

Prototype	<code>unsigned int SPI_Ethernet_24j600_doPacket();</code>
Description	<p>This is MAC module routine. It processes next received packet if such exists. Packets are processed in the following manner:</p> <ul style="list-style-type: none"> - ARP & ICMP requests are replied automatically. - upon TCP request the SPI_Ethernet_24j600_UserTCP function is called for further processing. - upon UDP request the SPI_Ethernet_24j600_UserUDP function is called for further processing.
Parameters	None.
Returns	<ul style="list-style-type: none"> - 0 - upon successful packet processing (zero packets received or received packet processed successfully). - 1 - upon reception error or receive buffer corruption. ENC24J600 controller needs to be restarted. - 2 - received packet was not sent to us (not our IP, nor IP broadcast address). - 3 - received IP packet was not IPv4. - 4 - received packet was of type unknown to the library.
Requires	Ethernet module has to be initialized. See SPI_Ethernet_24j600_Init.
Example	<pre>if (SPI_Ethernet_24j600_doPacket() == 0) (1) { // process received packets ... }</pre>
Notes	SPI_Ethernet_24j600_doPacket must be called as often as possible in user's code.

SPI_Ethernet_24j600_putByte

Prototype	<code>void SPI_Ethernet_24j600_putByte(unsigned char v);</code>
Description	This is MAC module routine. It stores one byte to address pointed by the current ENC24J600 write pointer (EWRPT).
Parameters	- v: value to store
Returns	Nothing.
Requires	Ethernet module has to be initialized. See SPI_Ethernet_24j600_Init.
Example	<pre>char data_; ... SPI_Ethernet_24j600_putByte(data); // put an byte into ENC24J600 buffer</pre>
Notes	None.

SPI_Ethernet_24j600_putBytes

Prototype	<code>void SPI_Ethernet_24j600_putBytes(unsigned char *ptr, unsigned int n);</code>
Description	This is MAC module routine. It stores requested number of bytes into ENC24J600 RAM starting from current ENC24J600 write pointer (EWRPT) location.
Parameters	- <code>ptr</code> : RAM buffer containing bytes to be written into ENC24J600 RAM. - <code>n</code> : number of bytes to be written.
Returns	Nothing.
Requires	Ethernet module has to be initialized. See SPI_Ethernet_24j600_Init.
Example	<pre>char *buffer = "mikroElektronika"; ... SPI_Ethernet_24j600_putBytes(buffer, 16); // put an RAM array into ENC24J600 buffer</pre>
Notes	None.

SPI_Ethernet_24j600_putConstBytes

Prototype	<code>void SPI_Ethernet_24j600_putConstBytes(const unsigned char *ptr, unsigned int n);</code>
Description	This is MAC module routine. It stores requested number of const bytes into ENC24J600 RAM starting from current ENC24J600 write pointer (EWRPT) location.
Parameters	- <code>ptr</code> : const buffer containing bytes to be written into ENC24J600 RAM. - <code>n</code> : number of bytes to be written.
Returns	Nothing.
Requires	Ethernet module has to be initialized. See SPI_Ethernet_24j600_Init.
Example	<pre>const char *buffer = "mikroElektronika"; ... SPI_Ethernet_24j600_putConstBytes(buffer, 16); // put a const array into ENC24J600 buffer</pre>
Notes	None.

SPI_Ethernet_24j600_putString

Prototype	<code>unsigned int SPI_Ethernet_24j600_putString(unsigned char *ptr);</code>
Description	This is MAC module routine. It stores whole string (excluding null termination) into ENC24J600 RAM starting from current ENC24J600 write pointer (EWRPT) location.
Parameters	- <code>ptr</code> : string to be written into ENC24J600 RAM.
Returns	Number of bytes written into ENC24J600 RAM.
Requires	Ethernet module has to be initialized. See SPI_Ethernet_24j600_Init.
Example	<pre>char *buffer = "mikroElektronika"; ... SPI_Ethernet_24j600_putString(buffer); // put a RAM string into ENC24J600 buffer</pre>
Notes	None.

SPI_Ethernet_24j600_putConstString

Prototype	<code>unsigned int SPI_Ethernet_24j600_putConstString(const unsigned char *ptr);</code>
Description	This is MAC module routine. It stores whole const string (excluding null termination) into ENC24J600 RAM starting from current ENC24J600 write pointer (EWRPT) location.
Parameters	- <code>ptr</code> : const string to be written into ENC24J600 RAM.
Returns	Number of bytes written into ENC24J600 RAM.
Requires	Ethernet module has to be initialized. See SPI_Ethernet_24j600_Init.
Example	<pre>const char *buffer = "mikroElektronika"; ... SPI_Ethernet_24j600_putConstString(buffer); // put a const string into ENC24J600 buffer</pre>
Notes	None.

SPI_Ethernet_24j600_getByte

Prototype	<code>unsigned char SPI_Ethernet_24j600_getByte();</code>
Description	This is MAC module routine. It fetches a byte from address pointed to by current ENC24J600 read pointer (ERDPT).
Parameters	None.
Returns	Byte read from ENC24J600 RAM.
Requires	Ethernet module has to be initialized. See SPI_Ethernet_24j600_Init.
Example	<pre>char buffer; ... buffer = SPI_Ethernet_24j600_getByte(); // read a byte from ENC24J600 buffer</pre>
Notes	None.

SPI_Ethernet_24j600_getBytes

Prototype	<code>void SPI_Ethernet_24j600_getBytes(unsigned char *ptr, unsigned int addr, unsigned int n);</code>
Description	This is MAC module routine. It fetches requested number of bytes from ENC24J600 RAM starting from given address. If value of 0xFFFF is passed as the address parameter, the reading will start from current ENC24J600 read pointer (ERDPT) location.
Parameters	- <code>ptr</code> : buffer for storing bytes read from ENC24J600 RAM. - <code>addr</code> : ENC24J600 RAM start address. Valid values: 0..8192. - <code>n</code> : number of bytes to be read.
Returns	Nothing.
Requires	Ethernet module has to be initialized. See SPI_Ethernet_24j600_Init.
Example	<pre>char buffer[16]; ... SPI_Ethernet_24j600_getBytes(buffer, 0x100, 16); // read 16 bytes, starting from address 0x100</pre>
Notes	None.

SPI_Ethernet_24j600_UserTCP

Prototype	<code>unsigned int SPI_Ethernet_24j600_UserTCP(unsigned char *remoteHost, unsigned int remotePort, unsigned int localPort, unsigned int reqLength, TETHj600PktFlags *flags);</code>
Description	This is TCP module routine. It is internally called by the library. The user accesses to the TCP request by using some of the SPI_Ethernet_24j600_get routines. The user puts data in the transmit buffer by using some of the SPI_Ethernet_24j600_put routines. The function must return the length in bytes of the TCP reply, or 0 if there is nothing to transmit. If there is no need to reply to the TCP requests, just define this function with return(0) as a single statement.
Parameters	- <code>remoteHost</code> : client's IP address. - <code>remotePort</code> : client's TCP port. - <code>localPort</code> : port to which the request is sent. - <code>reqLength</code> : TCP request data field length. - <code>flags</code> : structure consisted of two bit fields : Copy Code To Clipboard <pre>typedef struct { unsigned canCloseTCP: 1; // flag which closes socket unsigned isBroadcast: 1; // flag which denotes that the IP package has been received via subnet broadcast address } TETHj600PktFlags;</pre>
Returns	- 0 - there should not be a reply to the request. - Length of TCP reply data field - otherwise.
Requires	Ethernet module has to be initialized. See SPI_Ethernet_24j600_Init.
Example	This function is internally called by the library and should not be called by the user's code.
Notes	The function source code is provided with appropriate example projects. The code should be adjusted by the user to achieve desired reply.

SPI_Ethernet_24j600_UserUDP

Prototype	<code>unsigned int SPI_Ethernet_24j600_UserUDP(unsigned char *remoteHost, unsigned int remotePort, unsigned int destPort, unsigned int reqLength, TEthj600PktFlags *flags);</code>
Description	This is UDP module routine. It is internally called by the library. The user accesses to the UDP request by using some of the SPI_Ethernet_24j600_get routines. The user puts data in the transmit buffer by using some of the SPI_Ethernet_24j600_put routines. The function must return the length in bytes of the UDP reply, or 0 if nothing to transmit. If you don't need to reply to the UDP requests, just define this function with a return(0) as single statement.
Parameters	<ul style="list-style-type: none"> - remoteHost: client's IP address. - remotePort: client's port. - localPort: port to which the request is sent. - reqLength: UDP request data field length. - flags: structure consisted of two bit fields : <p>Copy Code To Clipboard</p> <pre>typedef struct { unsigned canCloseTCP: 1; // flag which closes TCP socket (not relevant to UDP) unsigned isBroadcast: 1; // flag which denotes that the IP package has been received via subnet broadcast address } TEthj600PktFlags;</pre>
Returns	<ul style="list-style-type: none"> - 0 - there should not be a reply to the request. - Length of UDP reply data field - otherwise.
Requires	Ethernet module has to be initialized. See SPI_Ethernet_24j600_Init.
Example	This function is internally called by the library and should not be called by the user's code.
Notes	The function source code is provided with appropriate example projects. The code should be adjusted by the user to achieve desired reply.

SPI_Ethernet_24j600_getIpAddress

Prototype	<code>unsigned char * SPI_Ethernet_24j600_getIpAddress();</code>
Description	This routine should be used when DHCP server is present on the network to fetch assigned IP address.
Parameters	None.
Returns	Pointer to the global variable holding IP address.
Requires	Ethernet module has to be initialized. See SPI_Ethernet_24j600_Init.
Example	<pre>unsigned char ipAddr[4]; // user IP address buffer ... memcpy(ipAddr, SPI_Ethernet_24j600_getIpAddress(), 4); // fetch IP address</pre>
Notes	User should always copy the IP address from the RAM location returned by this routine into it's own IP address buffer. These locations should not be altered by the user in any case!

SPI_Ethernet_24j600_getGwIpAddress

Prototype	<code>unsigned char * SPI_Ethernet_24j600_getGwIpAddress();</code>
Description	This routine should be used when DHCP server is present on the network to fetch assigned gateway IP address.
Parameters	None.
Returns	Pointer to the global variable holding gateway IP address.
Requires	Ethernet module has to be initialized. See SPI_Ethernet_24j600_Init.
Example	<pre> unsigned char gwIpAddr[4]; // user gateway IP address buffer ... memcpy(gwIpAddr, SPI_Ethernet_24j600_getGwIpAddress(), 4); // fetch gateway IP address </pre>
Notes	User should always copy the IP address from the RAM location returned by this routine into it's own gateway IP address buffer. These locations should not be altered by the user in any case!

SPI_Ethernet_24j600_getDnsIpAddress

Prototype	<code>unsigned char * SPI_Ethernet_24j600_getDnsIpAddress();</code>
Description	This routine should be used when DHCP server is present on the network to fetch assigned DNS IP address.
Parameters	None.
Returns	Pointer to the global variable holding DNS IP address.
Requires	Ethernet module has to be initialized. See SPI_Ethernet_24j600_Init.
Example	<pre> unsigned char dnsIpAddr[4]; // user DNS IP address buffer ... memcpy(dnsIpAddr, SPI_Ethernet_24j600_getDnsIpAddress(), 4); // fetch DNS server address </pre>
Notes	User should always copy the IP address from the RAM location returned by this routine into it's own DNS IP address buffer. These locations should not be altered by the user in any case!

SPI_Ethernet_24j600_getIpMask

Prototype	<code>unsigned char * SPI_Ethernet_24j600_getDnsIpAddress();</code>
Description	This routine should be used when DHCP server is present on the network to fetch assigned DNS IP address.
Parameters	None.
Returns	Pointer to the global variable holding DNS IP address.
Requires	Ethernet module has to be initialized. See SPI_Ethernet_24j600_Init.
Example	<pre> unsigned char dnsIpAddr[4]; // user DNS IP address buffer ... memcpy(dnsIpAddr, SPI_Ethernet_24j600_getDnsIpAddress(), 4); // fetch DNS server address </pre>
Notes	User should always copy the IP address from the RAM location returned by this routine into it's own DNS IP address buffer. These locations should not be altered by the user in any case!

SPI_Ethernet_24j600_confNetwork

Prototype	<code>void SPI_Ethernet_24j600_confNetwork(char *ipMask, char *gwIpAddr, char *dnsIpAddr);</code>
Description	Configures network parameters (IP subnet mask, gateway IP address, DNS IP address) when DHCP is not used.
Parameters	<ul style="list-style-type: none"> - ipMask: IP subnet mask. - gwIpAddr gateway IP address. - dnsIpAddr: DNS IP address.
Returns	Nothing.
Requires	Ethernet module has to be initialized. See SPI_Ethernet_24j600_Init.
Example	<pre> char ipMask[4] = {255, 255, 255, 0}; // network mask (for example : 255.255.255.0) char gwIpAddr[4] = {192, 168, 1, 1}; // gateway (router) IP address char dnsIpAddr[4] = {192, 168, 1, 1}; // DNS server IP address ... SPI_Ethernet_24j600_confNetwork(ipMask, gwIpAddr, dnsIpAddr); // set network configuration parameters </pre>
Notes	The above mentioned network parameters should be set by this routine only if DHCP module is not used. Otherwise DHCP will override these settings.

SPI_Ethernet_24j600_arpResolve

Prototype	<code>unsigned char *SPI_Ethernet_24j600_arpResolve(unsigned char *ip, unsigned char tmax);</code>
Description	This is ARP module routine. It sends an ARP request for given IP address and waits for ARP reply. If the requested IP address was resolved, an ARP cash entry is used for storing the configuration. ARP cash can store up to 3 entries. For ARP cash structure refer to “__EthEnc24j600.h” header file in the compiler’s Uses folder.
Parameters	- <code>ip</code> : IP address to be resolved. - <code>tmax</code> : time in seconds to wait for an reply.
Returns	- MAC address behind the IP address - the requested IP address was resolved. - 0 - otherwise.
Requires	Ethernet module has to be initialized. See SPI_Ethernet_24j600_Init.
Example	<pre>unsigned char IpAddr[4] = {192, 168, 1, 1}; // IP address ... SPI_Ethernet_24j600_arpResolve(IpAddr, 5); // get MAC address behind the above IP address, wait 5 secs for the response</pre>
Notes	The Ethernet services are not stopped while this routine waits for ARP reply. The incoming packets will be processed normally during this time.

SPI_Ethernet_24j600_sendUDP

Prototype	<code>unsigned int SPI_Ethernet_24j600_sendUDP(unsigned char *destIP, unsigned int sourcePort, unsigned int destPort, unsigned char *pkt, unsigned int pktLen);</code>
Description	This is UDP module routine. It sends an UDP packet on the network.
Parameters	- <code>destIP</code> : remote host IP address. - <code>sourcePort</code> : local UDP source port number. - <code>destPort</code> : destination UDP port number. - <code>pkt</code> : packet to transmit. - <code>pktLen</code> : length in bytes of packet to transmit.
Returns	- 1 - UDP packet was sent successfully. - 0 - otherwise.
Requires	Ethernet module has to be initialized. See SPI_Ethernet_24j600_Init.
Example	<pre>unsigned char IpAddr[4] = {192, 168, 1, 1}; // remote IP address ... SPI_Ethernet_24j600_sendUDP(IpAddr, 10001, 10001, "Hello", 5); // send Hello message to the above IP address, from UDP port 10001 to UDP port 10001</pre>
Notes	None.

SPI_Ethernet_24j600_dnsResolve

Prototype	<code>unsigned char * SPI_Ethernet_24j600_dnsResolve(unsigned char *host, unsigned char tmax);</code>
Description	This is DNS module routine. It sends an DNS request for given host name and waits for DNS reply. If the requested host name was resolved, it's IP address is stored in library global variable and a pointer containing this address is returned by the routine. UDP port 53 is used as DNS port.
Parameters	- <code>host</code> : host name to be resolved. - <code>tmax</code> : time in seconds to wait for an reply.
Returns	- pointer to the location holding the IP address - the requested host name was resolved. - 0 - otherwise.
Requires	Ethernet module has to be initialized. See SPI_Ethernet_24j600_Init.
Example	<pre> unsigned char * remoteHostIpAddr[4]; // user host IP address buffer ... // SNTP server: // Zurich, Switzerland: Integrated Systems Lab, Swiss Fed. Inst. of // Technology // 129.132.2.21: swisstime.ethz.ch // Service Area: Switzerland and Europe memcpy(remoteHostIpAddr, SPI_Ethernet_24j600_dnsResolve("swisstime.ethz. ch", 5), 4); </pre>
Notes	<p>The Ethernet services are not stopped while this routine waits for DNS reply. The incoming packets will be processed normally during this time.</p> <p>User should always copy the IP address from the RAM location returned by this routine into it's own resolved host IP address buffer. These locations should not be altered by the user in any case!</p>

SPI_Ethernet_24j600_initDHCP

Prototype	<code>unsigned int SPI_Ethernet_24j600_initDHCP(unsigned char tmax);</code>
Description	<p>This is DHCP module routine. It sends an DHCP request for network parameters (IP, gateway, DNS addresses and IP subnet mask) and waits for DHCP reply. If the requested parameters were obtained successfully, their values are stored into the library global variables.</p> <p>These parameters can be fetched by using appropriate library IP get routines:</p> <ul style="list-style-type: none"> - SPI_Ethernet_24j600_getIpAddress - fetch IP address. - SPI_Ethernet_24j600_getGwIpAddress - fetch gateway IP address. - SPI_Ethernet_24j600_getDnsIpAddress - fetch DNS IP address. - SPI_Ethernet_24j600_getIpMask - fetch IP subnet mask. <p>UDP port 68 is used as DHCP client port and UDP port 67 is used as DHCP server port.</p>
Parameters	- <code>tmax</code> : time in seconds to wait for an reply.
Returns	- 1 - network parameters were obtained successfully. - 0 - otherwise.
Requires	Ethernet module has to be initialized. See SPI_Ethernet_24j600_Init.
Example	<pre>... SPI_Ethernet_24j600_initDHCP(5); // get network configuration from DHCP server, wait 5 sec for the response ...</pre>
Notes	<p>The Ethernet services are not stopped while this routine waits for DNS reply. The incoming packets will be processed normally during this time.</p> <p>When DHCP module is used, global library variable <code>SPI_Ethernet_24j600_userTimerSec</code> is used to keep track of time. It is user responsibility to increment this variable each second in it's code.</p>

SPI_Ethernet_24j600_doDHCPLeaseTime

Prototype	<code>unsigned int SPI_Ethernet_24j600_doDHCPLeaseTime();</code>
Description	This is DHCP module routine. It takes care of IP address lease time by decrementing the global lease time library counter. When this time expires, it's time to contact DHCP server and renew the lease.
Parameters	None.
Returns	- 0 - lease time has not expired yet. - 1 - lease time has expired, it's time to renew it.
Requires	Ethernet module has to be initialized. See SPI_Ethernet_24j600_Init.
Example	<pre>while(1) { ... if (SPI_Ethernet_24j600_doDHCPLeaseTime()) ... // it's time to renew the IP address lease }</pre>
Notes	None.

SPI_Ethernet_24j600_renewDHCP

Prototype	<code>unsigned int SPI_Ethernet_24j600_renewDHCP(unsigned char tmax);</code>
Description	This is DHCP module routine. It sends IP address lease time renewal request to DHCP server.
Parameters	- <code>tmax</code> : time in seconds to wait for an reply.
Returns	- 1 - upon success (lease time was renewed). - 0 - otherwise (renewal request timed out).
Requires	Ethernet module has to be initialized. See SPI_Ethernet_24j600_Init.
Example	<pre>while(1) { ... if (SPI_Ethernet_24j600_doDHCPLeaseTime()) SPI_Ethernet_24j600_renewDHCP(5); // it's time to renew the IP address lease, with 5 secs for a reply ... }</pre>
Notes	None.

Library Example

This code shows how to use the Ethernet mini library :

- the board will reply to ARP & ICMP echo requests
- the board will reply to UDP requests on any port :
 - returns the request in upper char with a header made of remote host IP & port number
- the board will reply to HTTP requests on port 80, GET method with pathnames :
 - / will return the HTML main page
 - /s will return board status as text string
 - /t0 ... /t7 will toggle RD0 to RD7 bit and return HTML main page
 - all other requests return also HTML main page.

Copy Code To Clipboard

SPI Graphic Lcd Library

mikroC PRO for dsPIC30/33 and PIC24 provides a library for operating Graphic Lcd 128x64 (with commonly used Samsung KS108/KS107 controller) via SPI interface.

For creating a custom set of Glcd images use Glcd Bitmap Editor Tool.

Important :

- When using this library with dsPIC33 and PIC24 family MCUs be aware of their voltage incompatibility with certain number of Samsung KS0108 based Glcd modules.
So, additional external power supply for these modules may be required.
- Library uses the SPI module for communication. The user must initialize the appropriate SPI module before using the SPI Glcd Library.
- For MCUs with multiple SPI modules it is possible to initialize all of them and then switch by using the SPI_Set_Active() routine. See the SPI Library functions.
- This Library is designed to work with the mikroElektronika's Serial Lcd/Glcd Adapter Board pinout, see schematic at the bottom of this page for details.

Library Dependency Tree

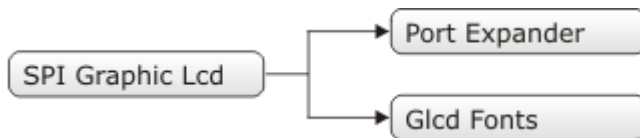

External dependencies of SPI Lcd Library

The implementation of SPI Lcd Library routines is based on Port Expander Library routines.

External dependencies are the same as Port Expander Library external dependencies.

Library Routines

Basic routines:

- SPI_Glcd_Init
- SPI_Glcd_Set_Side
- SPI_Glcd_Set_Page
- SPI_Glcd_Set_X
- SPI_Glcd_Read_Data
- SPI_Glcd_Write_Data

Advanced routines:

- SPI_Glcd_Fill
- SPI_Glcd_Dot
- SPI_Glcd_Line
- SPI_Glcd_V_Line
- SPI_Glcd_H_Line

- SPI_Glcd_Rectangle
- SPI_Glcd_Rectangle_Round_Edges
- SPI_Glcd_Rectangle_Round_Edges_Fill
- SPI_Glcd_Box
- SPI_Glcd_Circle
- SPI_Glcd_Circle_Fill
- SPI_Glcd_Set_Font
- SPI_Glcd_Write_Char
- SPI_Glcd_Write_Text
- SPI_Glcd_Image
- SPI_Glcd_PartialImage

SPI_Glcd_Init

Prototype	<code>void SPI_Glcd_Init(char DeviceAddress);</code>
Description	Initializes the Glcd module via SPI interface.
Parameters	- <code>DeviceAddress</code> : SPI expander hardware address, see schematic at the bottom of this page
Returns	Nothing.
Requires	<p>Global variables :</p> <ul style="list-style-type: none"> - <code>SPExpanderCS</code>: Chip Select line - <code>SPExpanderRST</code>: Reset line - <code>SPExpanderCS_Direction</code>: Direction of the Chip Select pin - <code>SPExpanderRST_Direction</code>: Direction of the Reset pin <p>must be defined before using this function.</p> <p>The SPI module needs to be initialized. See <code>SPIx_Init</code> and <code>SPIx_Init_Advanced</code> routines.</p>
Example	<pre>// Port Expander module connections sbit SPExpanderRST at LATF0_bit; sbit SPExpanderCS at LATF1_bit; sbit SPExpanderRST_Direction at TRISF0_bit; sbit SPExpanderCS_Direction at TRISF1_bit; // End Port Expander module connections ... // If Port Expander Library uses SPI module : SPI1_Init(); // Initialize SPI module used with PortExpander SPI_Glcd_Init(0);</pre>
Notes	None.

SPI_Glcd_Set_Side

Prototype	<code>void SPI_Glcd_Set_Side(char x_pos);</code>
Description	Selects Glcd side. Refer to the Glcd datasheet for detail explanation.
Parameters	- <code>x_pos</code> : position on x-axis. Valid values: 0..127 The parameter <code>x_pos</code> specifies the Glcd side: values from 0 to 63 specify the left side, values from 64 to 127 specify the right side.
Returns	Nothing.
Requires	Glcd needs to be initialized for SPI communication, see <code>SPI_Glcd_Init</code> routine.
Example	The following two lines are equivalent, and both of them select the left side of Glcd: <code>SPI_Glcd_Set_Side(0);</code> <code>SPI_Glcd_Set_Side(10);</code>
Notes	For side, x axis and page layout explanation see schematic at the bottom of this page.

SPI_Glcd_Set_Page

Prototype	<code>void SPI_Glcd_Set_Page(char page);</code>
Description	Selects page of Glcd.
Returns	- <code>page</code> : page number. Valid values: 0..7
Requires	Glcd needs to be initialized for SPI communication, see <code>SPI_Glcd_Init</code> routine.
Example	<code>SPI_Glcd_Set_Page(5);</code>
Notes	For side, x axis and page layout explanation see schematic at the bottom of this page.

SPI_Glcd_Set_X

Prototype	<code>void SPI_Glcd_Set_X(char x_pos);</code>
Description	Sets x-axis position to <code>x_pos</code> dots from the left border of Glcd within the selected side.
Parameters	- <code>x_pos</code> : position on x-axis. Valid values: 0..63
Returns	Nothing.
Requires	Glcd needs to be initialized for SPI communication, see <code>SPI_Glcd_Init</code> routine.
Example	<code>SPI_Glcd_Set_X(25);</code>
Notes	For side, x axis and page layout explanation see schematic at the bottom of this page.

SPI_Glcd_Read_Data

Prototype	<code>char SPI_Glcd_Read_Data();</code>
Description	Reads data from the current location of Glcd memory and moves to the next location.
Returns	One byte from Glcd memory.
Requires	Glcd needs to be initialized for SPI communication, see SPI_Glcd_Init routine. Glcd side, x-axis position and page should be set first. See the functions SPI_Glcd_Set_Side, SPI_Glcd_Set_X, and SPI_Glcd_Set_Page.
Parameters	None.
Example	<pre>char data_; ... data_ = SPI_Glcd_Read_Data();</pre>
Notes	None.

SPI_Glcd_Write_Data

Prototype	<code>void SPI_Glcd_Write_Data(char data_);</code>
Description	Writes one byte to the current location in Glcd memory and moves to the next location.
Parameters	- <code>data_</code> : data to be written
Returns	Nothing.
Requires	Glcd needs to be initialized for SPI communication, see SPI_Glcd_Init routine. Glcd side, x-axis position and page should be set first. See the functions SPI_Glcd_Set_Side, SPI_Glcd_Set_X, and SPI_Glcd_Set_Page.
Example	<pre>char data_; ... SPI_Glcd_Write_Data(data_);</pre>
Notes	None.

SPI_Glcd_Fill

Prototype	<code>void SPI_Glcd_Write_Data(char data_);</code>
Description	Writes one byte to the current location in Glcd memory and moves to the next location.
Parameters	- <code>data_</code> : data to be written
Returns	Nothing.
Requires	Glcd needs to be initialized for SPI communication, see SPI_Glcd_Init routine. Glcd side, x-axis position and page should be set first. See the functions SPI_Glcd_Set_Side, SPI_Glcd_Set_X, and SPI_Glcd_Set_Page.
Example	<pre>char data_; ... SPI_Glcd_Write_Data(data_);</pre>
Notes	None.

SPI_Glcd_Dot

Prototype	<code>void SPI_Glcd_Dot(char x_pos, char y_pos, char color);</code>
Description	Draws a dot on Glcd at coordinates (<code>x_pos</code> , <code>y_pos</code>).
Parameters	- <code>x_pos</code> : x position. Valid values: 0..127 - <code>y_pos</code> : y position. Valid values: 0..63 - <code>color</code> : color parameter. Valid values: 0..2 The parameter color determines the dot state: 0 clears dot, 1 puts a dot, and 2 inverts dot state.
Returns	Nothing.
Requires	Glcd needs to be initialized for SPI communication, see SPI_Glcd_Init routine.
Example	<pre>// Invert the dot in the upper left corner SPI_Glcd_Dot(0, 0, 2);</pre>
Notes	For x and y axis layout explanation see schematic at the bottom of this page..

SPI_Glcd_Line

Prototype	<code>void SPI_Glcd_Line(int x_start, int y_start, int x_end, int y_end, char color);</code>
Description	Draws a line on Glcd. Parameters :
Parameters	<ul style="list-style-type: none"> - <code>x_start</code>: x coordinate of the line start. Valid values: 0..127 - <code>y_start</code>: y coordinate of the line start. Valid values: 0..63 - <code>x_end</code>: x coordinate of the line end. Valid values: 0..127 - <code>y_end</code>: y coordinate of the line end. Valid values: 0..63 - <code>color</code>: color parameter. Valid values: 0..2 <p>Parameter <code>color</code> determines the line color: 0 white, 1 black, and 2 inverts each dot.</p>
Returns	Nothing.
Requires	Glcd needs to be initialized for SPI communication, see <code>SPI_Glcd_Init</code> routine.
Example	<pre>// Draw a line between dots (0,0) and (20,30) SPI_Glcd_Line(0, 0, 20, 30, 1);</pre>
Notes	For x and y axis layout explanation see schematic at the bottom of this page..

SPI_Glcd_V_Line

Prototype	<code>void SPI_Glcd_V_Line(char y_start, char y_end, char x_pos, char color);</code>
Description	Draws a vertical line on Glcd.
Parameters	<ul style="list-style-type: none"> - <code>y_start</code>: y coordinate of the line start. Valid values: 0..63 - <code>y_end</code>: y coordinate of the line end. Valid values: 0..63 - <code>x_pos</code>: x coordinate of vertical line. Valid values: 0..127 - <code>color</code>: color parameter. Valid values: 0..2 <p>Parameter <code>color</code> determines the line color: 0 white, 1 black, and 2 inverts each dot.</p>
Returns	Nothing.
Requires	Glcd needs to be initialized for SPI communication, see <code>SPI_Glcd_Init</code> routine.
Example	<pre>// Draw a vertical line between dots (10,5) and (10,25) SPI_Glcd_V_Line(5, 25, 10, 1);</pre>
Notes	None.

SPI_Glcd_H_Line

Prototype	<code>void SPI_Glcd_H_Line(char x_start, char x_end, char y_pos, char color);</code>
Description	Draws a horizontal line on Glcd.
Parameters	<ul style="list-style-type: none"> - <code>x_start</code>: x coordinate of the line start. Valid values: 0..127 - <code>x_end</code>: x coordinate of the line end. Valid values: 0..127 - <code>y_pos</code>: y coordinate of horizontal line. Valid values: 0..63 - <code>color</code>: color parameter. Valid values: 0..2 <p>The parameter <code>color</code> determines the line color: 0 white, 1 black, and 2 inverts each dot.</p>
Returns	Nothing.
Requires	Glcd needs to be initialized for SPI communication, see <code>SPI_Glcd_Init</code> routine.
Example	<pre>// Draw a horizontal line between dots (10,20) and (50,20) SPI_Glcd_H_Line(10, 50, 20, 1);</pre>
Notes	None.

SPI_Glcd_Rectangle

Prototype	<code>void SPI_Glcd_Rectangle(char x_upper_left, char y_upper_left, char x_bottom_right, char y_bottom_right, char color);</code>
Description	Draws a rectangle on Glcd.
Parameters	<ul style="list-style-type: none"> - <code>x_upper_left</code>: x coordinate of the upper left rectangle corner. Valid values: 0..127 - <code>y_upper_left</code>: y coordinate of the upper left rectangle corner. Valid values: 0..63 - <code>x_bottom_right</code>: x coordinate of the lower right rectangle corner. Valid values: 0..127 - <code>y_bottom_right</code>: y coordinate of the lower right rectangle corner. Valid values: 0..63 - <code>color</code>: color parameter. Valid values: 0..2 <p>The parameter <code>color</code> determines the color of the rectangle border: 0 white, 1 black, and 2 inverts each dot.</p>
Returns	Nothing.
Requires	Glcd needs to be initialized for SPI communication, see <code>SPI_Glcd_Init</code> routine.
Example	<pre>// Draw a rectangle between dots (5,5) and (40,40) SPI_Glcd_Rectangle(5, 5, 40, 40, 1);</pre>
Notes	None.

SPI_Glcd_Rectangle_Round_Edges

Prototype	<code>void SPI_Glcd_Rectangle_Round_Edges(unsigned short x_upper_left, unsigned short y_upper_left, unsigned short x_bottom_right, unsigned short y_bottom_right, unsigned short round_radius, unsigned short color);</code>
Description	Draws a rounded edge rectangle on Glcd.
Parameters	<ul style="list-style-type: none"> - <code>x_upper_left</code>: x coordinate of the upper left rectangle corner. Valid values: 0..127 - <code>y_upper_left</code>: y coordinate of the upper left rectangle corner. Valid values: 0..63 - <code>x_bottom_right</code>: x coordinate of the lower right rectangle corner. Valid values: 0..127 - <code>y_bottom_right</code>: y coordinate of the lower right rectangle corner. Valid values: 0..63 - <code>round_radius</code>: radius of the rounded edge. - <code>color</code>: color parameter. Valid values: 0..2
Returns	Nothing.
Requires	Glcd needs to be initialized, see SPI_Glcd_Init routine.
Example	<pre>// Draw a rounded edge rectangle between dots (5,5) and (40,40) with the radius of 12 SPI_Glcd_Rectangle_Round_Edges(5, 5, 40, 40, 12, 1);</pre>
Notes	None.

SPI_Glcd_Rectangle_Round_Edges_Fill

Prototype	<code>void SPI_Glcd_Rectangle_Round_Edges_Fill(unsigned short x_upper_left, unsigned short y_upper_left, unsigned short x_bottom_right, unsigned short y_bottom_right, unsigned short round_radius, unsigned short color);</code>
Description	Draws a filled rounded edge rectangle on Glcd with color.
Parameters	<ul style="list-style-type: none"> - <code>x_upper_left</code>: x coordinate of the upper left rectangle corner. Valid values: 0..127 - <code>y_upper_left</code>: y coordinate of the upper left rectangle corner. Valid values: 0..63 - <code>x_bottom_right</code>: x coordinate of the lower right rectangle corner. Valid values: 0..127 - <code>y_bottom_right</code>: y coordinate of the lower right rectangle corner. Valid values: 0..63 - <code>round_radius</code>: radius of the rounded edge - <code>color</code>: color parameter. Valid values: 0..2 <p>The parameter color determines the color of the rectangle border: 0 white, 1 black, and 2 inverts each dot.</p>
Returns	Nothing.
Requires	Glcd needs to be initialized, see SPI_Glcd_Init routine.
Example	<pre>// Draws a filled rounded edge rectangle between dots (5,5) and (40,40) with the radius of 12 SPI_Glcd_Rectangle_Round_Edges_Fill(5, 5, 40, 40, 12, 1);</pre>
Notes	None.

SPI_Glcd_Box

Prototype	<code>void SPI_Glcd_Box(char x_upper_left, char y_upper_left, char x_bottom_right, char y_bottom_right, char color);</code>
Description	Draws a box on Glcd.
Parameters	<ul style="list-style-type: none"> - <code>x_upper_left</code>: x coordinate of the upper left box corner. Valid values: 0..127 - <code>y_upper_left</code>: y coordinate of the upper left box corner. Valid values: 0..63 - <code>x_bottom_right</code>: x coordinate of the lower right box corner. Valid values: 0..127 - <code>y_bottom_right</code>: y coordinate of the lower right box corner. Valid values: 0..63 - <code>color</code>: color parameter. Valid values: 0..2 <p>The parameter color determines the color of the box fill: 0 white, 1 black, and 2 inverts each dot.</p>
Returns	Nothing.
Requires	Glcd needs to be initialized for SPI communication, see SPI_Glcd_Init routine.
Example	<pre>// Draw a box between dots (5,15) and (20,40) SPI_Glcd_Box(5, 15, 20, 40, 1);</pre>
Notes	None.

SPI_Glcd_Circle

Prototype	<code>void SPI_Glcd_Circle(int x_center, int y_center, int radius, char color);</code>
Description	Draws a circle on Glcd.
Parameters	<ul style="list-style-type: none"> - <code>x_center</code>: x coordinate of the circle center. Valid values: 0..127 - <code>y_center</code>: y coordinate of the circle center. Valid values: 0..63 - <code>radius</code>: radius size - <code>color</code>: color parameter. Valid values: 0..2 <p>The parameter color determines the color of the circle line: 0 white, 1 black, and 2 inverts each dot.</p>
Returns	Nothing.
Requires	Glcd needs to be initialized for SPI communication, see SPI_Glcd_Init routine.
Example	<pre>// Draw a circle with center in (50,50) and radius=10 SPI_Glcd_Circle(50, 50, 10, 1);</pre>
Notes	None.

SPI_Glcd_Circle_Fill

Prototype	<code>void SPI_Glcd_Circle_Fill(int x_center, int y_center, int radius, char color);</code>
Description	Draws a filled circle on Glcd.
Parameters	<ul style="list-style-type: none"> - <code>x_center</code>: x coordinate of the circle center. Valid values: 0..127 - <code>y_center</code>: y coordinate of the circle center. Valid values: 0..63 - <code>radius</code>: radius size - <code>color</code>: color parameter. Valid values: 0..2 <p>The parameter color determines the color of the circle : 0 white, 1 black, and 2 inverts each dot.</p>
Returns	Nothing.
Requires	Glcd needs to be initialized for SPI communication, see SPI_Glcd_Init routine.
Example	<pre>// Draw a circle with center in (50,50) and radius=10 SPI_Glcd_Circle_Fill(50, 50, 10, 1);</pre>
Notes	None.

SPI_Glcd_Set_Font

Prototype	<code>void SPI_Glcd_Set_Font(const code char *activeFont, char aFontWidth, char aFontHeight, unsigned int aFontOffs);</code>
Description	Sets font that will be used with SPI_Glcd_Write_Char and SPI_Glcd_Write_Text routines.
Parameters	None.
Returns	<p>- <code>activeFont</code>: font to be set. Needs to be formatted as an array of char</p> <p>- <code>aFontWidth</code>: width of the font characters in dots.</p> <p>- <code>aFontHeight</code>: height of the font characters in dots.</p> <p>- <code>aFontOffs</code>: number that represents difference between the mikroC PRO for dsPIC30/33 and PIC24 character set and regular ASCII set (eg. if 'A' is 65 in ASCII character, and 'A' is 45 in the mikroC PRO for dsPIC30/33 and PIC24 character set, aFontOffs is 20). Demo fonts supplied with the library have an offset of 32, which means that they start with space.</p> <p>The user can use fonts given in the file <code>__Lib_GLCDFonts</code> file located in the Uses folder or create his own fonts.</p> <p>List of supported fonts:</p> <ul style="list-style-type: none"> - <code>Font_Glcd_System3x5</code> - <code>Font_Glcd_System5x7</code> - <code>Font_Glcd_5x7</code> - <code>Font_Glcd_Character8x7</code> <p>For the sake of the backward compatibility, these fonts are supported also:</p> <ul style="list-style-type: none"> - <code>System3x5</code> (equivalent to <code>Font_Glcd_System3x5</code>) - <code>FontSystem5x7_v2</code> (equivalent to <code>Font_Glcd_System5x7</code>) - <code>font5x7</code> (equivalent to <code>Font_Glcd_5x7</code>) - <code>Character8x7</code> (equivalent to <code>Font_Glcd_Character8x7</code>)
Requires	Glcd needs to be initialized for SPI communication, see SPI_Glcd_Init routine.
Example	<pre>// Use the custom 5x7 font "myfont" which starts with space (32): SPI_Glcd_Set_Font(myfont, 5, 7, 32);</pre>
Notes	None.

SPI_Glcd_Write_Char

Prototype	<code>void SPI_Glcd_Write_Char(char chr1, char x_pos, char page_num, char color);</code>
Description	Prints character on Glcd.
Parameters	<ul style="list-style-type: none"> - <code>chr1</code>: character to be written - <code>x_pos</code>: character starting position on x-axis. Valid values: 0..(127-FontWidth) - <code>page_num</code>: the number of the page on which character will be written. Valid values: 0..7 - <code>color</code>: color parameter. Valid values: 0..2 <p>The parameter color determines the color of the character: 0 white, 1 black, and 2 inverts each dot.</p>
Returns	Nothing.
Requires	<p>Glcd needs to be initialized for SPI communication, see SPI_Glcd_Init routine.</p> <p>Use the SPI_Glcd_Set_Font to specify the font for display; if no font is specified, then the default Font_Glcd_System5x7 font supplied with the library will be used.</p>
Example	<pre>// Write character 'C' on the position 10 inside the page 2: SPI_Glcd_Write_Char('C', 10, 2, 1);</pre>
Notes	For x axis and page layout explanation see schematic at the bottom of this page.

SPI_Glcd_Write_Text

Prototype	<code>void SPI_Glcd_Write_Text(char text[], char x_pos, char page_num, char color);</code>
Description	Prints text on Glcd.
Parameters	<ul style="list-style-type: none"> - <code>text</code>: text to be written - <code>x_pos</code>: text starting position on x-axis. - <code>page_num</code>: the number of the page on which text will be written. Valid values: 0..7 - <code>color</code>: color parameter. Valid values: 0..2 <p>The parameter color determines the color of the text: 0 white, 1 black, and 2 inverts each dot.</p>
Returns	Nothing.
Requires	<p>Glcd needs to be initialized for SPI communication, see SPI_Glcd_Init routine.</p> <p>Use the SPI_Glcd_Set_Font to specify the font for display; if no font is specified, then the default Font_Glcd_System5x7 font supplied with the library will be used.</p>
Example	<pre>// Write text "Hello world!" on the position 10 inside the page 2: SPI_Glcd_Write_Text("Hello world!", 10, 2, 1);</pre>
Notes	For x axis and page layout explanation see schematic at the bottom of this page.

SPI_Glcd_Image

Prototype	<code>void SPI_Glcd_Image(const code char *image);</code>
Description	Displays bitmap on Glcd.
Parameters	- <code>image</code> : image to be displayed. Bitmap array can be located in both code and RAM memory (due to the mikroC PRO for dsPIC30/33 and PIC24 pointer to const and pointer to RAM equivalency).
Returns	Nothing.
Requires	Glcd needs to be initialized for SPI communication, see <code>SPI_Glcd_Init</code> routine.
Example	<pre>// Draw image my_image on Glcd SPI_Glcd_Image(my_image);</pre>
Notes	Use the mikroC PRO for dsPIC30/33 and PIC24 integrated Glcd Bitmap Editor, Tools > Glcd Bitmap Editor, to convert image to a constant array suitable for displaying on Glcd.

SPI_Glcd_PartialImage

Prototype	<code>void SPI_Glcd_PartialImage(unsigned int x_left, unsigned int y_top, unsigned int width, unsigned int height, unsigned int picture_width, unsigned int picture_height, code const unsigned short * image);</code>
Description	Displays a partial area of the image on a desired location.
Parameters	- <code>x_left</code> : x coordinate of the desired location (upper left coordinate). - <code>y_top</code> : y coordinate of the desired location (upper left coordinate). - <code>width</code> : desired image width. - <code>height</code> : desired image height. - <code>picture_width</code> : width of the original image. - <code>picture_height</code> : height of the original image. - <code>image</code> : image to be displayed. Bitmap array can be located in both code and RAM memory (due to the mikroC PRO for PIC pointer to const and pointer to RAM equivalency).
Returns	Nothing.
Requires	Glcd needs to be initialized for SPI communication, see <code>SPI_Glcd_Init</code> routine.
Example	<pre>// Draws a 10x15 part of the image starting from the upper left corner on the coordinate (10,12). Original image size is 16x32. SPI_Glcd_PartialImage(10, 12, 10, 15, 16, 32, image);</pre>
Notes	Use the mikroC PRO for dsPIC30/33 and PIC24 integrated Glcd Bitmap Editor, Tools > Glcd Bitmap Editor, to convert image to a constant array suitable for displaying on Glcd.

Library Example

The example demonstrates how to communicate to KS0108 Glcd via the SPI module, using serial to parallel convertor MCP23S17.

Copy Code To Clipboard

```

const code char truck_bmp[1024];

// Port Expander module connections
sbit SPExpanderRST at LATF0_bit;
sbit SPExpanderCS at LATF1_bit;
sbit SPExpanderRST_Direction at TRISF0_bit;
sbit SPExpanderCS_Direction at TRISF1_bit;
// End Port Expander module connections

void Delay2s() { // 2 seconds delay function
    Delay_ms(2000);
}

void main() {
    char counter;
    char *someText;

    #define COMPLETE_EXAMPLE
    ADPCFG = 0xFFFF; // initialize AN pins as digital

    // If Port Expander Library uses SPI1 module // Initialize SPI module used with
    SPI1_Init(); PortExpander

    SPI_Glcd_Init(0); // Initialize Glcd via SPI
    SPI_Glcd_Fill(0x00); // Clear Glcd
    Delay2s();

    while(1) {
        #ifdef COMPLETE_EXAMPLE
            SPI_Glcd_Image(truck_bmp); // Draw image
            Delay2s(); Delay2s();
        #endif
        SPI_Glcd_Fill(0x00); // Clear Glcd
        Delay2s();

        SPI_Glcd_Box(62,40,124,56,1); // Draw box
        SPI_Glcd_Rectangle(5,5,84,35,1); // Draw rectangle
        SPI_Glcd_Line(0, 63, 127, 0,1); // Draw line
        Delay2s();

        for(counter = 5; counter < 60; counter+=5 ) { // Draw horizontal and vertical line
            Delay_ms(250);
            SPI_Glcd_V_Line(2, 54, counter, 1);
            SPI_Glcd_H_Line(2, 120, counter, 1);
        }
    }
}

```

```
    Delay2s();

#ifdef COMPLETE_EXAMPLE
    SPI_Glcd_Fill(0x00);           // Clear Glcd
    SPI_Glcd_Set_Font(Character8x7, 8, 8, 32); // Choose font, see __Lib_GLCDFonts.c
in Uses folder
    SPI_Glcd_Write_Text("mikroE", 5, 7, 2); // Write string
#endif

    for (counter = 1; counter <= 10; counter++) // Draw circles
        SPI_Glcd_Circle(63,32, 3*counter, 1);
    Delay2s();

#ifdef COMPLETE_EXAMPLE
    SPI_Glcd_Box(12,20, 70,63, 2); // Draw box
    Delay2s();

    SPI_Glcd_Fill(0xFF); // Fill Glcd
    SPI_Glcd_Set_Font(Character8x7, 8, 7, 32); // Change font
    someText = "8x7 Font";
    SPI_Glcd_Write_Text(someText, 5, 1, 2); // Write string
    Delay2s();

    SPI_Glcd_Set_Font(System3x5, 3, 5, 32); // Change font
    someText = "3X5 CAPITALS ONLY";
    SPI_Glcd_Write_Text(someText, 5, 3, 2); // Write string
    Delay2s();

    SPI_Glcd_Set_Font(font5x7, 5, 7, 32); // Change font
    someText = "5x7 Font";
    SPI_Glcd_Write_Text(someText, 5, 5, 2); // Write string
    Delay2s();

    SPI_Glcd_Set_Font(FontSystem5x7_v2, 5, 7, 32); // Change font
    someText = "5x7 Font (v2)";
    SPI_Glcd_Write_Text(someText, 5, 7, 2); // Write string
    Delay2s();
#endif
}
}
```

SPI Lcd Library

The mikroC PRO for dsPIC30/33 and PIC24 provides a library for communication with Lcd (with HD44780 compliant controllers) in 4-bit mode via SPI interface.

For creating a custom set of Lcd characters use Lcd Custom Character Tool.

Important :

- When using this library with dsPIC33 and PIC24 family MCUs be aware of their voltage incompatibility with certain number of Lcd modules.
So, additional external power supply for these modules may be required.
- Library uses the SPI module for communication. The user must initialize the appropriate SPI module before using the SPI Lcd Library.
- For MCUs with multiple SPI modules it is possible to initialize all of them and then switch by using the `SPI_Set_Active()` routine. See the SPI Library functions.
- This Library is designed to work with the mikroElektronika's Serial Lcd Adapter Board pinout, see schematic at the bottom of this page for details.

Library Dependency Tree

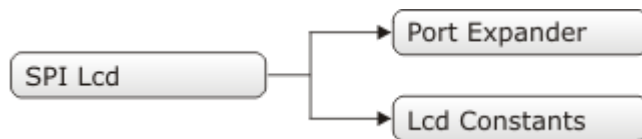

External dependencies of SPI Lcd Library

The implementation of SPI Lcd Library routines is based on Port Expander Library routines.

External dependencies are the same as Port Expander Library external dependencies.

Library Routines

- SPI_Lcd_Config
- SPI_Lcd_Out
- SPI_Lcd_Out_Cp
- SPI_Lcd_Chr
- SPI_Lcd_Chr_Cp
- SPI_Lcd_Cmd

SPI_Lcd_Config

Prototype	<code>void SPI_Lcd_Config(char DeviceAddress);</code>
Description	Initializes the Lcd module via SPI interface.
Parameters	- <code>DeviceAddress</code> : SPI expander hardware address, see schematic at the bottom of this page
Returns	Nothing.
Requires	<p>Global variables :</p> <ul style="list-style-type: none"> - <code>SPExpanderCS</code>: Chip Select line - <code>SPExpanderRST</code>: Reset line - <code>SPExpanderCS_Direction</code>: Direction of the Chip Select pin - <code>SPExpanderRST_Direction</code>: Direction of the Reset pin <p>must be defined before using this function.</p> <p>The SPI module needs to be initialized. See <code>SPIx_Init</code> and <code>SPIx_Init_Advanced</code> routines.</p>
Example	<pre>// Port Expander module connections sbit SPExpanderRST at LATF0_bit; sbit SPExpanderCS at LATF1_bit; sbit SPExpanderRST_Direction at TRISF0_bit; sbit SPExpanderCS_Direction at TRISF1_bit; // End Port Expander module connections // If Port Expander Library uses SPI1 module SPI1_Init(); // Initialize SPI module used with PortExpander SPI_Lcd_Config(0); // initialize Lcd over SPI interface</pre>
Notes	None.

SPI_Lcd_Out

Prototype	<code>void SPI_Lcd_Out(char row, char column, char *text);</code>
Description	Prints text on the Lcd starting from specified position. Both string variables and literals can be passed as a text.
Parameters	<ul style="list-style-type: none"> - <code>row</code>: starting position row number - <code>column</code>: starting position column number - <code>text</code>: text to be written
Returns	Nothing.
Requires	Lcd needs to be initialized for SPI communication, see <code>SPI_Lcd_Config</code> routine.
Example	<pre>// Write text "Hello!" on Lcd starting from row 1, column 3: SPI_Lcd_Out(1, 3, "Hello!");</pre>
Notes	None.

SPI_Lcd_Out_Cp

Prototype	<code>void SPI_Lcd_Out_CP(char *text);</code>
Description	Prints text on the Lcd at current cursor position. Both string variables and literals can be passed as a text.
Parameters	- <code>text</code> : text to be written
Returns	Nothing.
Requires	Lcd needs to be initialized for SPI communication, see SPI_Lcd_Config routine.
Example	<pre>// Write text "Here!" at current cursor position: SPI_Lcd_Out_CP("Here!");</pre>
Notes	None.

SPI_Lcd_Chr

Prototype	<code>void SPI_Lcd_Chr(char Row, char Column, char Out_Char);</code>
Description	Prints character on Lcd at specified position. Both variables and literals can be passed as character.
Parameters	- <code>Row</code> : writing position row number - <code>Column</code> : writing position column number - <code>Out_Char</code> : character to be written
Returns	Nothing.
Requires	Lcd needs to be initialized for SPI communication, see SPI_Lcd_Config routine.
Example	<pre>// Write character "i" at row 2, column 3: SPI_Lcd_Chr(2, 3, 'i');</pre>
Notes	None.

SPI_Lcd_Chr_Cp

Prototype	<code>void SPI_Lcd_Chr_CP(char Out_Char);</code>
Description	Prints character on Lcd at current cursor position. Both variables and literals can be passed as character.
Parameters	- <code>Out_Char</code> : character to be written
Returns	Nothing.
Requires	Lcd needs to be initialized for SPI communication, see SPI_Lcd_Config routine.
Example	<pre>// Write character "e" at current cursor position: SPI_Lcd_Chr_Cp('e');</pre>
Notes	None.

SPI_Lcd_Cmd

Prototype	<code>void SPI_Lcd_Cmd(char out_char);</code>
Description	Sends command to Lcd.
Parameters	- <code>out_char</code> : command to be sent
Returns	Nothing.
Requires	Lcd needs to be initialized for SPI communication, see SPI_Lcd_Config routine.
Example	<pre>// Clear Lcd display: SPI_Lcd_Cmd(_LCD_CLEAR);</pre>
Notes	Predefined constants can be passed to the routine, see Available SPI Lcd Commands.

SPI_Lcd_Cmd

SPI Lcd Command	Purpose
<code>_LCD_FIRST_ROW</code>	Move cursor to the 1st row
<code>_LCD_SECOND_ROW</code>	Move cursor to the 2nd row
<code>_LCD_THIRD_ROW</code>	Move cursor to the 3rd row
<code>_LCD_FOURTH_ROW</code>	Move cursor to the 4th row
<code>_LCD_CLEAR</code>	Clear display
<code>_LCD_RETURN_HOME</code>	Return cursor to home position, returns a shifted display to its original position. Display data RAM is unaffected.
<code>_LCD_CURSOR_OFF</code>	Turn off cursor
<code>_LCD_UNDERLINE_ON</code>	Underline cursor on
<code>_LCD_BLINK_CURSOR_ON</code>	Blink cursor on
<code>_LCD_MOVE_CURSOR_LEFT</code>	Move cursor left without changing display data RAM
<code>_LCD_MOVE_CURSOR_RIGHT</code>	Move cursor right without changing display data RAM
<code>_LCD_TURN_ON</code>	Turn Lcd display on
<code>_LCD_TURN_OFF</code>	Turn Lcd display off
<code>_LCD_SHIFT_LEFT</code>	Shift display left without changing display data RAM
<code>_LCD_SHIFT_RIGHT</code>	Shift display right without changing display data RAM

Library Example

Default Pin Configuration

Use SPI_Lcd_Init for default pin settings (see the first figure below).

Copy Code To Clipboard

```
char *text = "mikroElektronika";

// Port Expander module connections
sbit SPExpanderRST at LATF0_bit;
sbit SPExpanderCS at LATF1_bit;
sbit SPExpanderRST_Direction at TRISF0_bit;
sbit SPExpanderCS_Direction at TRISF1_bit;
// End Port Expander module connections

char i; // Loop variable

void Move_Delay() { // Function used for text moving
    Delay_ms(500); // You can change the moving speed here
}

void main() {
    ADPCFG = 0xFFFF; // initialize AN pins as digital

    // If Port Expander Library uses SPI1 module
    SPI1_Init(); // Initialize SPI module used with PortExpander

    SPI_Lcd_Config(0); // Initialize Lcd over SPI interface
    SPI_Lcd_Cmd(_LCD_CLEAR); // Clear display
    SPI_Lcd_Cmd(_LCD_CURSOR_OFF); // Turn cursor off
    SPI_Lcd_Out(1,6,"mikroE"); // Print text to Lcd, 1st row, 6th column
    SPI_Lcd_Chr_CP('!'); // Append '!'
    SPI_Lcd_Out(2,1, text); // Print text to Lcd, 2nd row, 1st column

    // SPI_Lcd_Out(3,1,"mikroE"); // For Lcd with more than two rows
    // SPI_Lcd_Out(4,15,"mikroE"); // For Lcd with more than two rows

    Delay_ms(2000);

    // Moving text
    for(i=0; i<4; i++) { // Move text to the right 4 times
        Spi_Lcd_Cmd(_LCD_SHIFT_RIGHT);
        Move_Delay();
    }

    while(1) { // Endless loop
        for(i=0; i<8; i++) { // Move text to the left 7 times
            Spi_Lcd_Cmd(_LCD_SHIFT_LEFT);
            Move_Delay();
        }

        for(i=0; i<8; i++) { // Move text to the right 7 times
            Spi_Lcd_Cmd(_LCD_SHIFT_RIGHT);
            Move_Delay();
        }
    }
}
```

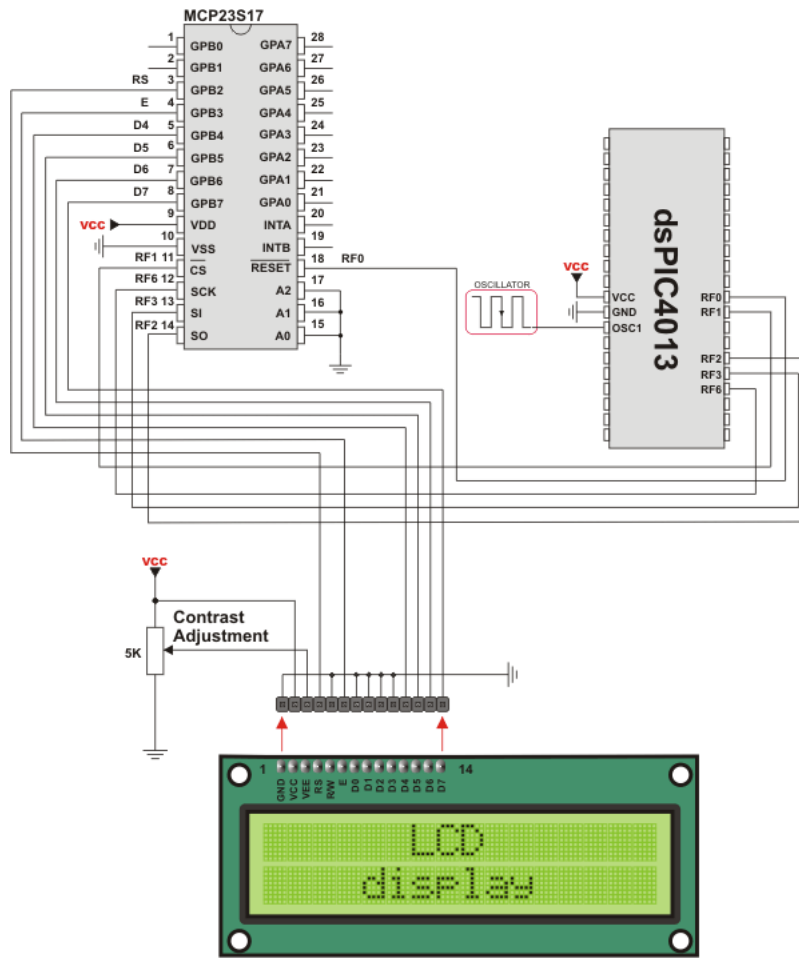

Lcd HW connection by default initialization (using SPI_Lcd_Init)

SPI Lcd8 (8-bit interface) Library

The mikroC PRO for dsPIC30/33 and PIC24 provides a library for communication with Lcd (with HD44780 compliant controllers) in 8-bit mode via SPI interface.

For creating a custom set of Lcd characters use Lcd Custom Character Tool.

Important :

- When using this library with dsPIC33 and PIC24 family MCUs be aware of their voltage incompatibility with certain number of Lcd modules.
So, additional external power supply for these modules may be required.
- Library uses the SPI module for communication. The user must initialize the appropriate SPI module before using the SPI Lcd8 Library.
- For MCUs with multiple SPI modules it is possible to initialize all of them and then switch by using the SPI_Set_Active() routine. See the SPI Library functions.
- This Library is designed to work with the mikroElektronika's Serial Lcd/Glcd Adapter Board pinout, see schematic at the bottom of this page for details.

Library Dependency Tree

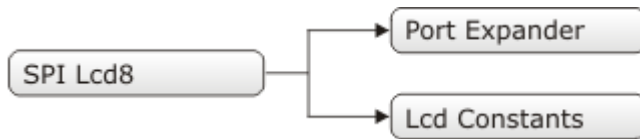

External dependencies of SPI Lcd Library

The implementation of SPI Lcd Library routines is based on Port Expander Library routines.

External dependencies are the same as Port Expander Library external dependencies.

Library Routines

- SPI_Lcd8_Config
- SPI_Lcd8_Out
- SPI_Lcd8_Out_Cp
- SPI_Lcd8_Chr
- SPI_Lcd8_Chr_Cp
- SPI_Lcd8_Cmd

SPI_Lcd8_Config

Prototype	<code>void SPI_Lcd8_Config(char DeviceAddress);</code>
Description	Initializes the Lcd module via SPI interface.
Parameters	- <code>DeviceAddress</code> : SPI expander hardware address, see schematic at the bottom of this page
Returns	Nothing.
Requires	<p>Global variables :</p> <ul style="list-style-type: none"> - <code>SPExpanderCS</code>: Chip Select line - <code>SPExpanderRST</code>: Reset line - <code>SPExpanderCS_Direction</code>: Direction of the Chip Select pin - <code>SPExpanderRST_Direction</code>: Direction of the Reset pin <p>must be defined before using this function.</p> <p>The SPI module needs to be initialized. See <code>SPIx_Init</code> and <code>SPIx_Init_Advanced</code> routines.</p>
Example	<pre>// Port Expander module connections sbit SPExpanderRST at LATF0_bit; sbit SPExpanderCS at LATF1_bit; sbit SPExpanderRST_Direction at TRISF0_bit; sbit SPExpanderCS_Direction at TRISF1_bit; // End Port Expander module connections ... // If Port Expander Library uses SPI1 module SPI1_Init(); // Initialize SPI module used with PortExpander SPI_Lcd8_Config(0); // intialize Lcd in 8bit mode via SPI</pre>
Notes	None.

SPI_Lcd8_Out

Prototype	<code>void SPI_Lcd8_Out(unsigned short row, unsigned short column, char *text);</code>
Description	Prints text on Lcd starting from specified position. Both string variables and literals can be passed as a text.
Parameters	- <code>row</code> : starting position row number - <code>column</code> : starting position column number - <code>text</code> : text to be written
Returns	Nothing.
Requires	Lcd needs to be initialized for SPI communication, see SPI_Lcd8_Config routine.
Example	<pre>// Write text "Hello!" on Lcd starting from row 1, column 3: SPI_Lcd8_Out(1, 3, "Hello!");</pre>
Notes	None.

SPI_Lcd8_Out_Cp

Prototype	<code>void SPI_Lcd8_Out_CP(char *text);</code>
Description	Prints text on Lcd at current cursor position. Both string variables and literals can be passed as a text.
Parameters	- <code>text</code> : text to be written
Returns	Nothing.
Requires	Lcd needs to be initialized for SPI communication, see SPI_Lcd8_Config routine.
Example	<pre>// Write text "Here!" at current cursor position: SPI_Lcd8_Out_Cp("Here!");</pre>
Notes	None.

SPI_Lcd8_Chr

Prototype	<code>void SPI_Lcd8_Chr(unsigned short row, unsigned short column, char out_char);</code>
Description	Prints character on Lcd at specified position. Both variables and literals can be passed as character.
Parameters	- <code>row</code> : writing position row number - <code>column</code> : writing position column number - <code>out_char</code> : character to be written
Returns	Nothing.
Requires	Lcd needs to be initialized for SPI communication, see SPI_Lcd8_Config routine.
Example	<pre>// Write character "i" at row 2, column 3: SPI_Lcd8_Chr(2, 3, 'i');</pre>
Notes	None.

SPI_Lcd8_Chr_Cp

Prototype	<code>void SPI_Lcd8_Chr_CP(char out_char);</code>
Description	Prints character on Lcd at current cursor position. Both variables and literals can be passed as character.
Parameters	- <code>out_char</code> : character to be written
Returns	Nothing.
Requires	Lcd needs to be initialized for SPI communication, see <code>SPI_Lcd8_Config</code> routine.
Example	Print "e" at current cursor position: <pre>// Write character "e" at current cursor position: SPI_Lcd8_Chr_Cp('e');</pre>
Notes	None.

SPI_Lcd8_Cmd

Prototype	<code>void SPI_Lcd8_Cmd(char out_char);</code>
Description	Sends command to Lcd.
Parameters	- <code>out_char</code> : command to be sent
Returns	Nothing.
Requires	Lcd needs to be initialized for SPI communication, see <code>SPI_Lcd8_Config</code> routine.
Example	<pre>// Clear Lcd display: SPI_Lcd8_Cmd(_LCD_CLEAR);</pre>
Notes	Predefined constants can be passed to the routine, see Available SPI Lcd8 Commands.

Available SPI Lcd8 Commands

SPI Lcd8 Command	Purpose
<code>_LCD_FIRST_ROW</code>	Move cursor to the 1st row
<code>_LCD_SECOND_ROW</code>	Move cursor to the 2nd row
<code>_LCD_THIRD_ROW</code>	Move cursor to the 3rd row
<code>_LCD_FOURTH_ROW</code>	Move cursor to the 4th row
<code>_LCD_CLEAR</code>	Clear display
<code>_LCD_RETURN_HOME</code>	Return cursor to home position, returns a shifted display to its original position. Display data RAM is unaffected.
<code>_LCD_CURSOR_OFF</code>	Turn off cursor
<code>_LCD_UNDERLINE_ON</code>	Underline cursor on
<code>_LCD_BLINK_CURSOR_ON</code>	Blink cursor on
<code>_LCD_MOVE_CURSOR_LEFT</code>	Move cursor left without changing display data RAM
<code>_LCD_MOVE_CURSOR_RIGHT</code>	Move cursor right without changing display data RAM
<code>_LCD_TURN_ON</code>	Turn Lcd display on
<code>_LCD_TURN_OFF</code>	Turn Lcd display off
<code>_LCD_SHIFT_LEFT</code>	Shift display left without changing display data RAM
<code>_LCD_SHIFT_RIGHT</code>	Shift display right without changing display data RAM

Library Example

This example demonstrates how to communicate Lcd in 8-bit mode via the SPI module, using serial to parallel convertor MCP23S17.

Copy Code To Clipboard

```
char *text = "mikroElektronika";

// Port Expander module connections
sbit SPExpanderRST at LATF0_bit;
sbit SPExpanderCS at LATF1_bit;
sbit SPExpanderRST_Direction at TRISF0_bit;
sbit SPExpanderCS_Direction at TRISF1_bit;
// End Port Expander module connections

char i; // Loop variable

void Move_Delay() { // Function used for text moving
    Delay_ms(500); // You can change the moving speed here
}

void main() {

// If Port Expander Library uses SPI1 module
    SPI1_Init(); // Initialize SPI module used with PortExpander
```

```

SPI_Lcd8_Config(0); // Initialize Lcd over SPI interface
SPI_Lcd8_Cmd(_LCD_CLEAR); // Clear display
SPI_Lcd8_Cmd(_LCD_CURSOR_OFF); // Turn cursor off
SPI_Lcd8_Out(1,6, "mikroE"); // Print text to Lcd, 1st row, 6th column
SPI_Lcd8_Chr_CP('!'); // Append '!'
SPI_Lcd8_Out(2,1, text); // Print text to Lcd, 2nd row, 1st column

// SPI_Lcd8_Out(3,1,"mikroE"); // For Lcd with more than two rows
// SPI_Lcd8_Out(4,15,"mikroE"); // For Lcd with more than two rows

Delay_ms(2000);

// Moving text
for(i=0; i<4; i++) { // Move text to the right 4 times
    Spi_Lcd8_Cmd(_LCD_SHIFT_RIGHT);
    Move_Delay();
}

while(1) { // Endless loop
    for(i=0; i<8; i++) { // Move text to the left 7 times
        Spi_Lcd8_Cmd(_LCD_SHIFT_LEFT);
        Move_Delay();
    }

    for(i=0; i<8; i++) { // Move text to the right 7 times
        Spi_Lcd8_Cmd(_LCD_SHIFT_RIGHT);
        Move_Delay();
    }
}
}

```

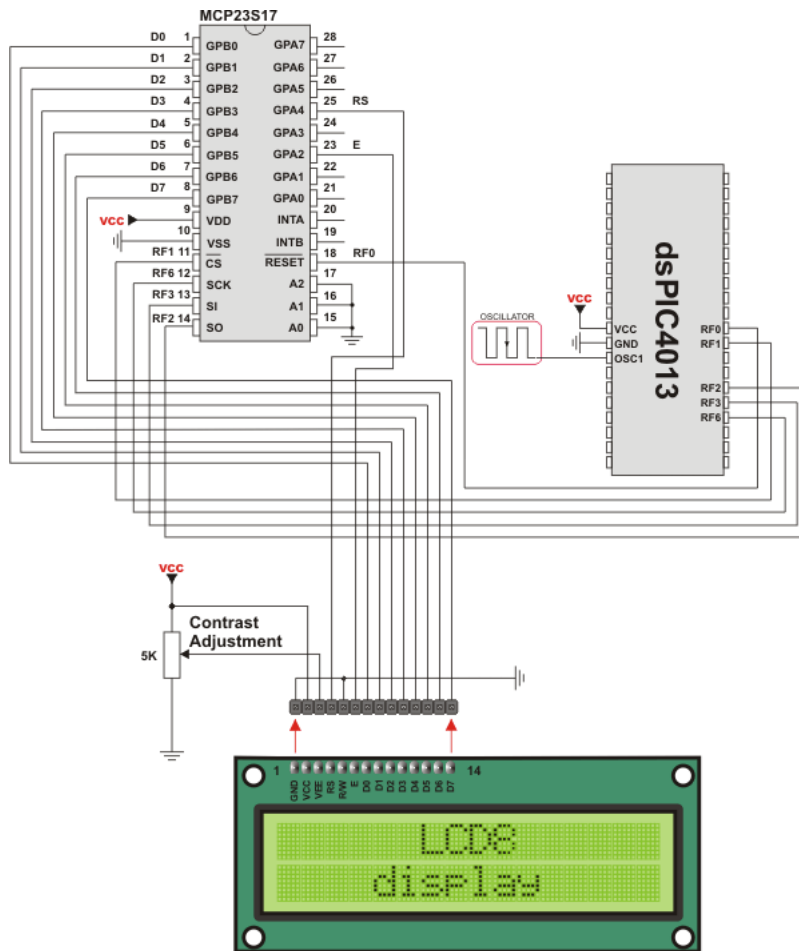
SPI Lcd8 HW connection

SPI T6963C Graphic Lcd Library

The mikroC PRO for dsPIC30/33 and PIC24 provides a library for working with Glcds based on TOSHIBA T6963C controller via SPI interface. The Toshiba T6963C is a very popular Lcd controller for the use in small graphics modules. It is capable of controlling displays with a resolution up to 240x128. Because of its low power and small outline it is most suitable for mobile applications such as PDAs, MP3 players or mobile measurement equipment. Although this controller is small, it has a capability of displaying and merging text and graphics and it manages all interfacing signals to the displays Row and Column drivers.

For creating a custom set of Glcd images use Glcd Bitmap Editor Tool.

Important :

- When using this library with dsPIC33 and PIC24 family MCUs be aware of their voltage incompatibility with certain number of T6963C based Glcd modules. So, additional external power supply for these modules may be required.
- Glcd size based initialization routines can be found in setup library files located in the Uses folder.
- The user must make sure that used MCU has appropriate ports and pins. If this is not the case the user should adjust initialization routines.
- The library uses the SPI module for communication. The user must initialize the appropriate SPI module before using the SPI T6963C Glcd Library.
- For MCUs with multiple SPI modules it is possible to initialize both of them and then switch by using the `SPI_Set_Active()` routine. See the SPI Library functions.
- This Library is designed to work with mikroElektronika's Serial Glcd 240x128 and 240x64 Adapter Boards pinout, see schematic at the bottom of this page for details.
- To use constants located in `__Lib_SPIT6963C_Const.h` file, user must include it the source file : `#include "__SPIT6963C.h"`.

Some mikroElektronika's adapter boards have pinout different from T6369C datasheets. Appropriate relations between these labels are given in the table below :

Adapter Board	T6369C datasheet
RS	C/D
R/W	/RD
E	/WR

Library Dependency Tree

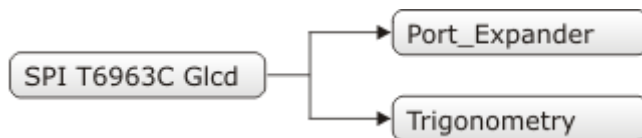

External dependencies of SPI T6963C Graphic Lcd Library

The implementation of SPI T6963C Graphic Lcd Library routines is based on Port Expander Library routines.

External dependencies are the same as Port Expander Library external dependencies.

Library Routines

- SPI_T6963C_config
- SPI_T6963C_writeData
- SPI_T6963C_writeCommand
- SPI_T6963C_setPtr
- SPI_T6963C_waitReady
- SPI_T6963C_fill
- SPI_T6963C_dot
- SPI_T6963C_write_char
- SPI_T6963C_write_text
- SPI_T6963C_line
- SPI_T6963C_rectangle
- SPI_T6963C_rectangle_round_edges
- SPI_T6963C_rectangle_round_edges_fill
- SPI_T6963C_box
- SPI_T6963C_circle
- SPI_T6963C_circle_fill
- SPI_T6963C_image
- SPI_T6963C_PartialImage
- SPI_T6963C_sprite
- SPI_T6963C_set_cursor
- SPI_T6963C_clearBit
- SPI_T6963C_setBit
- SPI_T6963C_negBit

The following low level library routines are implemented as macros. These macros can be found in the `__SPIT6963C.h` header file which is located in the SPI T6963C example projects folders.

- SPI_T6963C_displayGrPanel
- SPI_T6963C_displayTxtPanel
- SPI_T6963C_setGrPanel
- SPI_T6963C_setTxtPanel
- SPI_T6963C_panelFill
- SPI_T6963C_grFill
- SPI_T6963C_txtFill
- SPI_T6963C_cursor_height
- SPI_T6963C_graphics
- SPI_T6963C_text
- SPI_T6963C_cursor
- SPI_T6963C_cursor_blink

SPI_Lcd8_Cmd

Prototype	<code>void SPI_T6963C_config(unsigned int width, unsigned char height, unsigned char fntW, char DeviceAddress, unsigned char wr, unsigned char rd, unsigned char cd, unsigned char rst);</code>
Description	<p>Initializes T6963C Graphic Lcd controller.</p> <p>Display RAM organization: The library cuts RAM into panels : a complete panel is one graphics panel followed by a text panel (see schematic below).</p> <pre>+-----+ /\ + GRAPHICS PANEL #0 + + + + + + + +-----+ PANEL 0 + TEXT PANEL #0 + + + \ +-----+ /\ + GRAPHICS PANEL #1 + + + + + + + +-----+ PANEL 1 + TEXT PANEL #1 + + + +-----+ \</pre>
Parameters	<ul style="list-style-type: none"> - <code>width</code>: width of the Glcd panel - <code>height</code>: height of the Glcd panel - <code>fntW</code>: font width - <code>DeviceAddress</code>: SPI expander hardware address, see schematic at the bottom of this page - <code>wr</code>: write signal pin on Glcd control port - <code>rd</code>: read signal pin on Glcd control port - <code>cd</code>: command/data signal pin on Glcd control port - <code>rst</code>: reset signal pin on Glcd control port
Returns	Nothing.
Requires	<p>Global variables :</p> <ul style="list-style-type: none"> - <code>SPExpanderCS</code>: Chip Select line - <code>SPExpanderRST</code>: Reset line - <code>SPExpanderCS_Direction</code>: Direction of the Chip Select pin - <code>SPExpanderRST_Direction</code>: Direction of the Reset pin <p>must be defined before using this function.</p> <p>The SPI module needs to be initialized. See the <code>SPIx_Init</code> and <code>SPIx_Init_Advanced</code> routines.</p>

Example	<pre>// Port Expander module connections sbit SPExpanderRST at LATF0_bit; sbit SPExpanderCS at LATF1_bit; sbit SPExpanderRST_Direction at TRISF0_bit; sbit SPExpanderCS_Direction at TRISF1_bit; // End Port Expander module connections ... // Initialize SPI module SPI1_Init(); SPI_T6963C_Config(240, 64, 8, 0, 0, 1, 3, 4);</pre>
Notes	None.

SPI_T6963C_writeData

Prototype	<code>void SPI_T6963C_writeData(unsigned char data_);</code>
Description	Writes data to T6963C controller via SPI interface.
Parameters	- <code>data_</code> : data to be written
Returns	Nothing.
Requires	Toshiba Glcd module needs to be initialized. See SPI_T6963C_Config routine.
Example	<code>SPI_T6963C_writeData(data_);</code>
Notes	None.

SPI_T6963C_writeCommand

Prototype	<code>void SPI_T6963C_writeCommand(unsigned char data_);</code>
Description	Writes command to T6963C controller via SPI interface.
Parameters	- <code>data_</code> : command to be written
Returns	Nothing.
Requires	Toshiba Glcd module needs to be initialized. See SPI_T6963C_Config routine.
Example	<code>SPI_T6963C_writeCommand(SPI_T6963C_CURSOR_POINTER_SET);</code>
Notes	None.

SPI_T6963C_setPtr

Prototype	<code>void SPI_T6963C_setPtr(unsigned int p, unsigned char c);</code>
Description	Sets the memory pointer p for command p.
Parameters	- p: address where command should be written - c: command to be written
Returns	Nothing.
Requires	Toshiba Glcd module needs to be initialized. See SPI_T6963C_Config routine.
Example	<code>SPI_T6963C_setPtr(SPI_T6963C_grHomeAddr + start, SPI_T6963C_ADDRESS_POINTER_SET);</code>
Notes	None.

SPI_T6963C_waitReady

Prototype	<code>void SPI_T6963C_waitReady();</code>
Description	Pools the status byte, and loops until Toshiba Glcd module is ready.
Parameters	None.
Returns	Nothing.
Requires	Toshiba Glcd module needs to be initialized. See SPI_T6963C_Config routine.
Example	<code>SPI_T6963C_waitReady();</code>
Notes	None.

SPI_T6963C_fill

Prototype	<code>void SPI_T6963C_fill(unsigned char v, unsigned int start, unsigned int len);</code>
Description	Fills controller memory block with given byte.
Parameters	- v: byte to be written - start: starting address of the memory block - len: length of the memory block in bytes
Returns	Nothing.
Requires	Toshiba Glcd module needs to be initialized. See SPI_T6963C_Config routine.
Example	<code>SPI_T6963C_fill(0x33, 0x00FF, 0x000F);</code>
Notes	None.

SPI_T6963C_dot

Prototype	<code>void SPI_T6963C_dot(int x, int y, unsigned char color);</code>
Description	Writes a char in the current text panel of Glcd at coordinates (x, y).
Returns	- x : dot position on x-axis - y : dot position on y-axis - color : color parameter. Valid values: SPI_T6963C_BLACK and SPI_T6963C_WHITE
Requires	Toshiba Glcd module needs to be initialized. See SPI_T6963C_Config routine.
Example	<code>SPI_T6963C_dot(x0, y0, SPI_T6963C_BLACK);</code>
Notes	None.

SPI_T6963C_write_char

Prototype	<code>void SPI_T6963C_write_char(unsigned char c, unsigned char x, unsigned char y, unsigned char mode);</code>
Description	Writes a char in the current text panel of Glcd at coordinates (x, y).
Parameters	- c : char to be written - x : char position on x-axis - y : char position on y-axis - mode : mode parameter. Valid values: SPI_T6963C_ROM_MODE_OR, SPI_T6963C_ROM_MODE_XOR, SPI_T6963C_ROM_MODE_AND and SPI_T6963C_ROM_MODE_TEXT Mode parameter explanation: - OR Mode: In the OR-Mode, text and graphics can be displayed and the data is logically "OR-ed". This is the most common way of combining text and graphics for example labels on buttons. - XOR-Mode: In this mode, the text and graphics data are combined via the logical "exclusive OR". This can be useful to display text in negative mode, i.e. white text on black background. - AND-Mode: The text and graphic data shown on display are combined via the logical "AND function". - TEXT-Mode: This option is only available when displaying just a text. The Text Attribute values are stored in the graphic area of display memory. For more details see the T6963C datasheet.
Returns	Nothing.
Requires	Toshiba Glcd module needs to be initialized. See SPI_T6963C_Config routine.
Example	<code>SPI_T6963C_write_char("A", 22, 23, SPI_T6963C_ROM_MODE_AND);</code>
Notes	None.

SPI_T6963C_write_text

Prototype	<code>void SPI_T6963C_write_text(unsigned char *str, unsigned char x, unsigned char y, unsigned char mode);</code>
Description	Writes text in the current text panel of Glcd at coordinates (x, y).
Parameters	<ul style="list-style-type: none"> - <code>str</code>: text to be written - <code>x</code>: text position on x-axis - <code>y</code>: text position on y-axis - <code>mode</code>: mode parameter. Valid values: SPI_T6963C_ROM_MODE_OR, SPI_T6963C_ROM_MODE_XOR, SPI_T6963C_ROM_MODE_AND and SPI_T6963C_ROM_MODE_TEXT <p>Mode parameter explanation:</p> <ul style="list-style-type: none"> - OR Mode: In the OR-Mode, text and graphics can be displayed and the data is logically "OR-ed". This is the most common way of combining text and graphics for example labels on buttons. - XOR-Mode: In this mode, the text and graphics data are combined via the logical "exclusive OR". This can be useful to display text in negative mode, i.e. white text on black background. - AND-Mode: The text and graphic data shown on the display are combined via the logical "AND function". - TEXT-Mode: This option is only available when displaying just a text. The Text Attribute values are stored in the graphic area of display memory. <p>For more details see the T6963C datasheet.</p>
Returns	Nothing.
Requires	Toshiba Glcd module needs to be initialized. See SPI_T6963C_Config routine.
Example	<code>SPI_T6963C_write_text("Glcd LIBRARY DEMO, WELCOME !", 0, 0, SPI_T6963C_ROM_MODE_XOR);</code>
Notes	None.

SPI_T6963C_line

Prototype	<code>void SPI_T6963C_line(int x0, int y0, int x1, int y1, unsigned char pcolor);</code>
Description	Draws a line from (x0, y0) to (x1, y1).
Parameters	<ul style="list-style-type: none"> - <code>x0</code>: x coordinate of the line start - <code>y0</code>: y coordinate of the line end - <code>x1</code>: x coordinate of the line start - <code>y1</code>: y coordinate of the line end - <code>pcolor</code>: color parameter. Valid values: SPI_T6963C_BLACK and SPI_T6963C_WHITE
Returns	Nothing.
Requires	Toshiba Glcd module needs to be initialized. See SPI_T6963C_Config routine.
Example	<code>SPI_T6963C_line(0, 0, 239, 127, SPI_T6963C_WHITE);</code>
Notes	None.

SPI_T6963C_rectangle

Prototype	<code>void SPI_T6963C_rectangle(int x0, int y0, int x1, int y1, unsigned char pcolor);</code>
Description	Draws a rectangle on Glcd.
Parameters	<ul style="list-style-type: none"> - <code>x0</code>: x coordinate of the upper left rectangle corner - <code>y0</code>: y coordinate of the upper left rectangle corner - <code>x1</code>: x coordinate of the lower right rectangle corner - <code>y1</code>: y coordinate of the lower right rectangle corner - <code>pcolor</code>: color parameter. Valid values: SPI_T6963C_BLACK and SPI_T6963C_WHITE
Returns	Nothing.
Requires	Toshiba Glcd module needs to be initialized. See SPI_T6963C_Config routine.
Example	<code>SPI_T6963C_rectangle(20, 20, 219, 107, SPI_T6963C_WHITE);</code>
Notes	None.

SPI_T6963C_rectangle_round_edges

Prototype	<code>void SPI_T6963C_rectangle_round_edges(int x0, int y0, int x1, int y1, int round_radius, unsigned char pcolor);</code>
Description	Draws a rounded edge rectangle on Glcd.
Parameters	<ul style="list-style-type: none"> - <code>x0</code>: x coordinate of the upper left rectangle corner - <code>y0</code>: y coordinate of the upper left rectangle corner - <code>x1</code>: x coordinate of the lower right rectangle corner - <code>y1</code>: y coordinate of the lower right rectangle corner - <code>round_radius</code>: radius of the rounded edge. - <code>pcolor</code>: color parameter. Valid values: <code>SPI_T6963C_BLACK</code> and <code>SPI_T6963C_WHITE</code>
Returns	Nothing.
Requires	Toshiba Glcd module needs to be initialized. See <code>SPI_T6963C_Config</code> routine.
Example	<code>SPI_T6963C_rectangle_round_edges(20, 20, 219, 107, 12, SPI_T6963C_WHITE);</code>
Notes	None.

SPI_T6963C_rectangle_round_edges_fill

Prototype	<code>void SPI_T6963C_rectangle_round_edges_fill(int x0, int y0, int x1, int y1, int round_radius, unsigned char pcolor);</code>
Description	Draws a filled rounded edge rectangle on Glcd.
Parameters	<ul style="list-style-type: none"> - <code>x0</code>: x coordinate of the upper left rectangle corner - <code>y0</code>: y coordinate of the upper left rectangle corner - <code>x1</code>: x coordinate of the lower right rectangle corner - <code>y1</code>: y coordinate of the lower right rectangle corner - <code>round_radius</code>: radius of the rounded edge - <code>pcolor</code>: color parameter. Valid values: <code>SPI_T6963C_BLACK</code> and <code>SPI_T6963C_WHITE</code>
Returns	Nothing.
Requires	Toshiba Glcd module needs to be initialized. See <code>SPI_T6963C_Config</code> routine.
Example	<code>SPI_T6963C_rectangle_round_edges_fill(20, 20, 219, 107, 12, SPI_T6963C_WHITE);</code>
Notes	None.

SPI_T6963C_box

Prototype	<code>void SPI_T6963C_box(int x0, int y0, int x1, int y1, unsigned char pcolor);</code>
Description	Draws a box on the Glcd
Parameters	<ul style="list-style-type: none"> - <code>x0</code>: x coordinate of the upper left box corner - <code>y0</code>: y coordinate of the upper left box corner - <code>x1</code>: x coordinate of the lower right box corner - <code>y1</code>: y coordinate of the lower right box corner - <code>pcolor</code>: color parameter. Valid values: SPI_T6963C_BLACK and SPI_T6963C_WHITE
Returns	Nothing.
Requires	Toshiba Glcd module needs to be initialized. See SPI_T6963C_Config routine.
Example	<code>SPI_T6963C_box(0, 119, 239, 127, SPI_T6963C_WHITE);</code>
Notes	None.

SPI_T6963C_circle

Prototype	<code>void SPI_T6963C_circle(int x, int y, long r, unsigned char pcolor);</code>
Description	Draws a circle on the Glcd.
Parameters	<ul style="list-style-type: none"> - <code>x</code>: x coordinate of the circle center - <code>y</code>: y coordinate of the circle center - <code>r</code>: radius size - <code>pcolor</code>: color parameter. Valid values: SPI_T6963C_BLACK and SPI_T6963C_WHITE
Returns	Nothing.
Requires	Toshiba Glcd module needs to be initialized. See SPI_T6963C_Config routine.
Example	<code>SPI_T6963C_circle(120, 64, 110, SPI_T6963C_WHITE);</code>
Notes	None.

SPI_T6963C_circle_fill

Prototype	<code>void SPI_T6963C_circle_fill(int x, int y, long r, unsigned char pcolor);</code>
Description	Draws a filled circle on the Glcd.
Parameters	<ul style="list-style-type: none"> - <code>x</code>: x coordinate of the circle center - <code>y</code>: y coordinate of the circle center - <code>r</code>: radius size - <code>pcolor</code>: color parameter. Valid values: SPI_T6963C_BLACK and SPI_T6963C_WHITE
Returns	Nothing.
Requires	Toshiba Glcd module needs to be initialized. See SPI_T6963C_Config routine.
Example	<code>SPI_T6963C_circle_fill(120, 64, 110, SPI_T6963C_WHITE);</code>
Notes	None.

SPI_T6963C_image

Prototype	<code>void SPI_T6963C_image(const code char *pic);</code>
Description	Displays bitmap on Glcd.
Parameters	- <code>pic</code> : image to be displayed. Bitmap array can be located in both code and RAM memory (due to the mikroC PRO for dsPIC30/33 and PIC24 pointer to const and pointer to RAM equivalency).
Returns	Nothing.
Requires	Toshiba Glcd module needs to be initialized. See SPI_T6963C_Config routine.
Example	<code>SPI_T6963C_image(my_image);</code>
Notes	Image dimension must match the display dimension. Use the integrated Glcd Bitmap Editor (menu option Tools > Glcd Bitmap Editor) to convert image to a constant array suitable for displaying on Glcd.

SPI_T6963C_PartialImage

Prototype	<code>void SPI_T6963C_PartialImage(unsigned int x_left, unsigned int y_top, unsigned int width, unsigned int height, unsigned int picture_width, unsigned int picture_height, code const unsigned short * image);</code>
Description	Displays a partial area of the image on a desired location.
Parameters	- <code>x_left</code> : x coordinate of the desired location (upper left coordinate). - <code>y_top</code> : y coordinate of the desired location (upper left coordinate). - <code>width</code> : desired image width. - <code>height</code> : desired image height. - <code>picture_width</code> : width of the original image. - <code>picture_height</code> : height of the original image. - <code>image</code> : image to be displayed. Bitmap array can be located in both code and RAM memory (due to the mikroC PRO for PIC pointer to const and pointer to RAM equivalency).
Returns	Nothing.
Requires	Toshiba Glcd module needs to be initialized. See SPI_T6963C_Config routine.
Example	<code>// Draws a 10x15 part of the image starting from the upper left corner on the coordinate (10,12). Original image size is 16x32. SPI_T6963C_PartialImage(10, 12, 10, 15, 16, 32, image);</code>
Notes	Image dimension must match the display dimension. Use the integrated Glcd Bitmap Editor (menu option Tools > Glcd Bitmap Editor) to convert image to a constant array suitable for displaying on Glcd.

SPI_T6963C_sprite

Prototype	<code>void SPI_T6963C_sprite(unsigned char px, unsigned char py, const code char *pic, unsigned char sx, unsigned char sy);</code>
Description	Fills graphic rectangle area (px, py) to (px+sx, py+sy) with custom size picture.
Parameters	<ul style="list-style-type: none"> - <code>px</code>: x coordinate of the upper left picture corner. Valid values: multiples of the font width - <code>py</code>: y coordinate of the upper left picture corner - <code>pic</code>: picture to be displayed - <code>sx</code>: picture width. Valid values: multiples of the font width - <code>sy</code>: picture height
Returns	Nothing.
Requires	Toshiba Glcd module needs to be initialized. See SPI_T6963C_Config routine.
Example	<code>SPI_T6963C_sprite(76, 4, einstein, 88, 119); // draw a sprite</code>
Notes	If px and sx parameters are not multiples of the font width they will be scaled to the nearest lower number that is a multiple of the font width.

SPI_T6963C_set_cursor

Prototype	<code>void SPI_T6963C_set_cursor(unsigned char x, unsigned char y);</code>
Description	Sets cursor to row x and column y.
Parameters	<ul style="list-style-type: none"> - <code>x</code>: cursor position row number - <code>y</code>: cursor position column number
Returns	Nothing.
Requires	Toshiba Glcd module needs to be initialized. See SPI_T6963C_Config routine.
Example	<code>SPI_T6963C_set_cursor(cposx, cposy);</code>
Notes	None.

SPI_T6963C_clearBit

Prototype	<code>void SPI_T6963C_clearBit(char b);</code>
Description	Clears control port bit(s).
Parameters	- <code>b</code> : bit mask. The function will clear bit <code>x</code> on control port if bit <code>x</code> in bit mask is set to 1.
Returns	Nothing.
Requires	Toshiba Glcd module needs to be initialized. See SPI_T6963C_Config routine.
Example	<pre>// clear bits 0 and 1 on control port SPI_T6963C_clearBit(0x03);</pre>
Notes	None.

SPI_T6963C_setBit

Prototype	<code>void SPI_T6963C_setBit(char b);</code>
Description	Sets control port bit(s).
Parameters	- b : bit mask. The function will set bit x on control port if bit x in bit mask is set to 1.
Returns	Nothing.
Requires	Toshiba Glcd module needs to be initialized. See SPI_T6963C_Config routine.
Example	<pre>// set bits 0 and 1 on control port SPI_T6963C_setBit(0x03);</pre>
Notes	None.

SPI_T6963C_negBit

Prototype	<code>void SPI_T6963C_negBit(char b);</code>
Description	Negates control port bit(s).
Parameters	- b : bit mask. The function will negate bit x on control port if bit x in bit mask is set to 1.
Returns	Nothing.
Requires	Toshiba Glcd module needs to be initialized. See SPI_T6963C_Config routine.
Example	<pre>// negate bits 0 and 1 on control port SPI_T6963C_negBit(0x03);</pre>
Notes	None.

SPI_T6963C_displayGrPanel

Prototype	<code>void SPI_T6963C_displayGrPanel(unsigned int n);</code>
Description	Display selected graphic panel.
Parameters	- n : graphic panel number. Valid values: 0 and 1.
Returns	Nothing.
Requires	Toshiba Glcd module needs to be initialized. See SPI_T6963C_Config routine.
Example	<pre>// display graphic panel 1 SPI_T6963C_displayGrPanel(1);</pre>
Notes	None.

SPI_T6963C_displayTxtPanel

Prototype	<code>void SPI_T6963C_displayTxtPanel(unsigned int n);</code>
Description	Display selected text panel.
Parameters	- n: text panel number. Valid values: 0 and 1.
Returns	Nothing.
Requires	Toshiba Glcd module needs to be initialized. See SPI_T6963C_Config routine.
Example	<pre>// display text panel 1 SPI_T6963C_displayTxtPanel(1);</pre>
Notes	None.

SPI_T6963C_setGrPanel

Prototype	<code>void SPI_T6963C_setGrPanel(unsigned int n);</code>
Description	Compute start address for selected graphic panel and set appropriate internal pointers. All subsequent graphic operations will be preformed at this graphic panel.
Parameters	- n: graphic panel number. Valid values: 0 and 1.
Returns	Nothing.
Requires	Toshiba Glcd module needs to be initialized. See SPI_T6963C_Config routine.
Example	<pre>// set graphic panel 1 as current graphic panel. SPI_T6963C_setGrPanel(1);</pre>
Notes	None.

SPI_T6963C_setTxtPanel

Prototype	<code>void SPI_T6963C_setTxtPanel(unsigned int n);</code>
Description	Compute start address for selected text panel and set appropriate internal pointers. All subsequent text operations will be preformed at this text panel.
Parameters	- n: text panel number. Valid values: 0 and 1.
Returns	Nothing.
Requires	Toshiba Glcd module needs to be initialized. See SPI_T6963C_Config routine.
Example	<pre>// set text panel 1 as current text panel. SPI_T6963C_setTxtPanel(1);</pre>
Notes	None.

SPI_T6963C_panelFill

Prototype	<code>void SPI_T6963C_panelFill(unsigned char v);</code>
Description	Fill current panel in full (graphic+text) with appropriate value (0 to clear).
Parameters	- <code>v</code> : value to fill panel with.
Returns	Nothing.
Requires	Toshiba Glcd module needs to be initialized. See SPI_T6963C_Config routine.
Example	<pre>clear current panel SPI_T6963C_panelFill(0);</pre>
Notes	None.

SPI_T6963C_grFill

Prototype	<code>void SPI_T6963C_grFill(unsigned char v);</code>
Description	Fill current graphic panel with appropriate value (0 to clear).
Parameters	- <code>v</code> : value to fill graphic panel with.
Returns	Nothing.
Requires	Toshiba Glcd module needs to be initialized. See SPI_T6963C_Config routine.
Example	<pre>// clear current graphic panel SPI_T6963C_grFill(0);</pre>
Notes	None.

SPI_T6963C_txtFill

Prototype	<code>void SPI_T6963C_txtFill(unsigned char v);</code>
Description	Fill current text panel with appropriate value (0 to clear).
Parameters	- <code>v</code> : this value increased by 32 will be used to fill text panel.
Returns	Nothing.
Requires	Toshiba Glcd module needs to be initialized. See SPI_T6963C_Config routine.
Example	<pre>// clear current text panel SPI_T6963C_txtFill(0);</pre>
Notes	None.

SPI_T6963C_cursor_height

Prototype	<code>void SPI_T6963C_cursor_height(unsigned char n);</code>
Description	Set cursor size.
Parameters	- <i>n</i> : cursor height. Valid values: 0..7.
Returns	Nothing.
Requires	Toshiba Glcd module needs to be initialized. See SPI_T6963C_Config routine.
Example	<code>SPI_T6963C_cursor_height(7);</code>
Notes	None.

SPI_T6963C_graphics

Prototype	<code>void SPI_T6963C_graphics(unsigned int n);</code>
Description	Enable/disable graphic displaying.
Parameters	- <i>n</i> : graphic enable/disable parameter. Valid values: 0 (disable graphic displaying) and 1 (enable graphic displaying).
Returns	Nothing.
Requires	Toshiba Glcd module needs to be initialized. See SPI_T6963C_Config routine.
Example	<code>// enable graphic displaying SPI_T6963C_graphics(1);</code>
Notes	None.

SPI_T6963C_text

Prototype	<code>void SPI_T6963C_text(unsigned int n);</code>
Description	Enable/disable text displaying.
Parameters	- <i>n</i> : text enable/disable parameter. Valid values: 0 (disable text displaying) and 1 (enable text displaying).
Returns	Nothing.
Requires	Toshiba Glcd module needs to be initialized. See SPI_T6963C_Config routine.
Example	<code>// enable text displaying SPI_T6963C_text(1);</code>
Notes	None.

SPI_T6963C_cursor

Prototype	<code>void SPI_T6963C_cursor(unsigned int n);</code>
Description	Set cursor on/off.
Parameters	- n: on/off parameter. Valid values: 0 (set cursor off) and 1 (set cursor on).
Returns	Nothing.
Requires	Toshiba Glcd module needs to be initialized. See SPI_T6963C_Config routine.
Example	<pre>// set cursor on SPI_T6963C_cursor(1);</pre>
Notes	None.

SPI_T6963C_cursor_blink

Prototype	<code>void SPI_T6963C_cursor_blink(unsigned int n);</code>
Description	Enable/disable cursor blinking.
Parameters	- n: cursor blinking enable/disable parameter. Valid values: 0 (disable cursor blinking) and 1 (enable cursor blinking).
Returns	Nothing.
Requires	Toshiba Glcd module needs to be initialized. See SPI_T6963C_Config routine.
Example	<pre>// enable cursor blinking SPI_T6963C_cursor_blink(1);</pre>
Notes	None.

Library Example

The following drawing demo tests advanced routines of the SPI T6963C Glcd library. Hardware configurations in this example are made for the EasydsPIC3 board and dsPIC30F4013.

Copy Code To Clipboard

```
#include "__SPIT6963C.h"

/*
 * bitmap pictures stored in ROM
 */
const code char mikroE_240x128_bmp[];
const code char einstein[];

// Port Expander module connections
sbit SPExpanderRST at LATF0_bit;
sbit SPExpanderCS at LATF1_bit;
sbit SPExpanderRST_Direction at TRISF0_bit;
sbit SPExpanderCS_Direction at TRISF1_bit;
// End Port Expander module connections

void main() {
    char txt1[] = " EINSTEIN WOULD HAVE LIKED mE";
    char txt[] = " GLCD LIBRARY DEMO, WELCOME !";
```

```
unsigned char panel;           // Current panel
unsigned int  i;              // General purpose register
unsigned char curs;          // Cursor visibility
unsigned int  cposx, cposy;   // Cursor x-y position

#define COMPLETE_EXAMPLE     // comment this line to make simpler/smaller example

ADPCFG = 0xFFFF;

TRISB0_bit = 1;              // Set RB0 as input
TRISB1_bit = 1;              // Set RB1 as input
TRISB2_bit = 1;              // Set RB2 as input
TRISB3_bit = 1;              // Set RB3 as input
TRISB4_bit = 1;              // Set RB4 as input

// If Port Expander Library uses SPI1 module
SPI1_Init();                 // Initialize SPI module used with PortExpander

// // If Port Expander Library uses SPI2 module
// SPI2_Init();              // Initialize SPI module used with PortExpander

/*
 * init display for 240 pixel width and 128 pixel height
 * 8 bits character width
 * data bus on MCP23S17 portB
 * control bus on MCP23S17 portA
 * bit 2 is !WR
 * bit 1 is !RD
 * bit 0 is !CD
 * bit 4 is RST
 * chip enable, reverse on, 8x8 font internally set in library
 */

SPI_T6963C_Config(240, 128, 8, 0, 2, 1, 0, 4);
Delay_ms(1000);

/*
 * Enable both graphics and text display at the same time
 */
SPI_T6963C_graphics(1);
SPI_T6963C_text(1);

panel = 0;
i = 0;
curs = 0;
cposx = cposy = 0;
/*
 * Text messages
 */
SPI_T6963C_write_text(txt, 0, 0, SPI_T6963C_ROM_MODE_XOR);
SPI_T6963C_write_text(txt1, 0, 15, SPI_T6963C_ROM_MODE_XOR);
```

```

/*
 * Cursor
 */
SPI_T6963C_cursor_height(8);           // 8 pixel height
SPI_T6963C_set_cursor(0, 0);          // move cursor to top left
SPI_T6963C_cursor(0);                 // cursor off

/*
 * Draw rectangles
 */
SPI_T6963C_rectangle(0, 0, 239, 127, SPI_T6963C_WHITE);
SPI_T6963C_rectangle(20, 20, 219, 107, SPI_T6963C_WHITE);
SPI_T6963C_rectangle(40, 40, 199, 87, SPI_T6963C_WHITE);
SPI_T6963C_rectangle(60, 60, 179, 67, SPI_T6963C_WHITE);

/*
 * Draw a cross
 */
SPI_T6963C_line(0, 0, 239, 127, SPI_T6963C_WHITE);
SPI_T6963C_line(0, 127, 239, 0, SPI_T6963C_WHITE);

/*
 * Draw solid boxes
 */
SPI_T6963C_box(0, 0, 239, 8, SPI_T6963C_WHITE);
SPI_T6963C_box(0, 119, 239, 127, SPI_T6963C_WHITE);

#ifdef COMPLETE_EXAMPLE
/*
 * Draw circles
 */
SPI_T6963C_circle(120, 64, 10, SPI_T6963C_WHITE);
SPI_T6963C_circle(120, 64, 30, SPI_T6963C_WHITE);
SPI_T6963C_circle(120, 64, 50, SPI_T6963C_WHITE);
SPI_T6963C_circle(120, 64, 70, SPI_T6963C_WHITE);
SPI_T6963C_circle(120, 64, 90, SPI_T6963C_WHITE);
SPI_T6963C_circle(120, 64, 110, SPI_T6963C_WHITE);
SPI_T6963C_circle(120, 64, 130, SPI_T6963C_WHITE);

SPI_T6963C_sprite(76, 4, einstein, 88, 119);           // Draw a sprite

SPI_T6963C_setGrPanel(1);                               // Select other graphic
panel

SPI_T6963C_image(mikroE_240x128_bmp);                   // Draw an image

#endif

for(;;) {                                               // Endless loop
/*
 * If RB0 is pressed, display only graphic panel
 */

```

```

if(RB0_bit) {
    SPI_T6963C_graphics(1);
    SPI_T6963C_text(0);
    Delay_ms(300);
}
#ifndef COMPLETE_EXAMPLE
/*
    * If RB1 is pressed, toggle the display between graphic panel 0 and graphic panel
1
    */
    else if(RB1_bit) {
        panel++;
        panel &= 1;
        SPI_T6963C_displayGrPanel(panel);
        Delay_ms(300);
    }
#endif
/*
    * If RB2 is pressed, display only text panel
    */
else if(RB2_bit) {
    SPI_T6963C_graphics(0);
    SPI_T6963C_text(1);
    Delay_ms(300);
}

/*
    * If RB3 is pressed, display text and graphic panels
    */
else if(RB3_bit) {
    SPI_T6963C_graphics(1);
    SPI_T6963C_text(1);
    Delay_ms(300);
}
/*
    * If RB4 is pressed, change cursor
    */
else if(RB4_bit) {
    curs++;
    if(curs == 3) curs = 0;
    switch(curs) {
        case 0:
            // no cursor
            SPI_T6963C_cursor(0);
            break;
        case 1:
            // blinking cursor
            SPI_T6963C_cursor(1);
            SPI_T6963C_cursor_blink(1);
            break;
        case 2:
            // non blinking cursor
            SPI_T6963C_cursor(1);
            SPI_T6963C_cursor_blink(0);
            break;
    }
}

```

```
    Delay_ms(300);
}

/*
 * Move cursor, even if not visible
 */
cposx++;
if(cposx == SPI_T6963C_txtCols) {
    cposx = 0;
    cposy++;
    if(cposy == SPI_T6963C_grHeight / SPI_T6963C_CHARACTER_HEIGHT) {
        cposy = 0;
    }
}
SPI_T6963C_set_cursor(cposx, cposy);

Delay_ms(100);
}
}
```

HW Connection

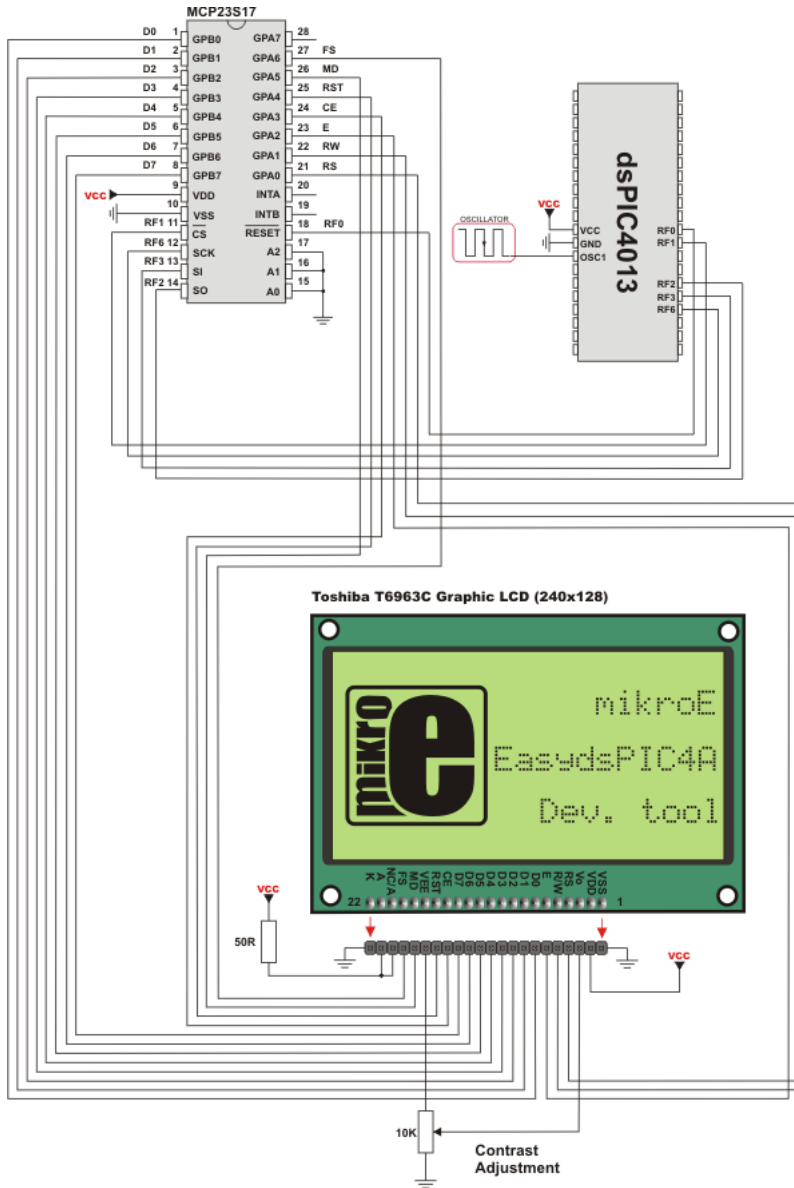

SPI T6963C Glcd HW connection

T6963C Graphic Lcd Library

The mikroC PRO for dsPIC30/33 and PIC24 provides a library for working with Glcds based on TOSHIBA T6963C controller. The Toshiba T6963C is a very popular Lcd controller for the use in small graphics modules. It is capable of controlling displays with a resolution up to 240x128. Because of its low power and small outline it is most suitable for mobile applications such as PDAs, MP3 players or mobile measurement equipment. Although small, this controller has a capability of displaying and merging text and graphics and it manages all the interfacing signals to the displays Row and Column drivers.

For creating a custom set of Glcd images use Glcd Bitmap Editor Tool.

Important :

- When using this library with dsPIC33 and PIC24 family of MCUs be aware of their voltage incompatibility with certain number of T6963C based Glcd modules. So, additional external power supply for these modules may be required.
- ChipEnable(CE), FontSelect(FS) and Reverse(MD) have to be set to appropriate levels by the user outside of the T6963C_Init() function. See the Library Example code at the bottom of this page.
- Glcd size based initialization routines can be found in setup library files located in the Uses folder.
- The user must make sure that used MCU has appropriate ports and pins. If this is not the case the user should adjust initialization routines.

Some mikroElektronika's adapter boards have pinout different from T6369C datasheets. Appropriate relations between these labels are given in the table below :

Adapter Board	T6369C datasheet
RS	C/D
R/W	/RD
E	/WR

Library Dependency Tree



Library Dependency Tree

The following variables must be defined in all projects using T6963C Graphic Lcd library:	Description :	Example :
<code>extern sfr unsigned int T6963C_dataPort;</code>	T6963C Data Port.	<code>char T6963C_dataPort at PORTB;</code>
<code>extern sfr sbit T6963C_ctrlwr;</code>	Write signal.	<code>sbit T6963C_ctrlwr at LATF2_bit;</code>
<code>extern sfr sbit T6963C_ctrlrd;</code>	Read signal.	<code>sbit T6963C_ctrlrd at LATF1_bit;</code>
<code>extern sfr sbit T6963C_ctrlcd;</code>	Command/Data signal.	<code>sbit T6963C_ctrlcd at LATF0_bit;</code>
<code>extern sfr sbit T6963C_ctrlrst;</code>	Reset signal.	<code>sbit T6963C_ctrlrst at LATF4_bit;</code>
<code>extern sfr sbit T6963C_ctrlwr_Direction;</code>	Direction of the Write pin.	<code>sbit T6963C_ctrlwr_Direction at TRISF2_bit;</code>
<code>extern sfr sbit T6963C_ctrlrd_Direction;</code>	Direction of the Read pin.	<code>sbit T6963C_ctrlrd_Direction at TRISF1_bit;</code>
<code>extern sfr sbit T6963C_ctrlcd_Direction;</code>	Direction of the Command/Data pin.	<code>sbit T6963C_ctrlcd_Direction at TRISF0_bit;</code>
<code>extern sfr sbit T6963C_ctrlrst_Direction;</code>	Direction of the Reset pin.	<code>sbit T6963C_ctrlrst_Direction at TRISF4_bit;</code>

Library Routines

- T6963C_init
- T6963C_writeData
- T6963C_writeCommand
- T6963C_setPtr
- T6963C_waitReady
- T6963C_fill
- T6963C_dot
- T6963C_write_char
- T6963C_write_text
- T6963C_line
- T6963C_rectangle
- T6963C_rectangle_round_edges
- T6963C_rectangle_round_edges_fill
- T6963C_box
- T6963C_circle
- T6963C_circle_fill
- T6963C_image
- T6963C_PartialImage
- T6963C_sprite
- T6963C_set_cursor

The following low level library routines are implemented as macros. These macros can be found in the `__T6963C.h` header file which is located in the T6963C example projects folders.

- T6963C_clearBit
- T6963C_setBit
- T6963C_negBit
- T6963C_displayGrPanel
- T6963C_displayTxtPanel
- T6963C_setGrPanel
- T6963C_setTxtPanel
- T6963C_panelFill
- T6963C_grFill
- T6963C_txtFill
- T6963C_cursor_height
- T6963C_graphics
- T6963C_text
- T6963C_cursor
- T6963C_cursor_blink

SPI_T6963C_cursor

Prototype	<code>void T6963C_init(unsigned int width, unsigned char height, unsigned char fntW);</code>
Description	<p>Initializes the Graphic Lcd controller.</p> <p>Display RAM organization: The library cuts the RAM into panels : a complete panel is one graphics panel followed by a text panel (see schematic below).</p> <pre> +-----+ /\ + GRAPHICS PANEL #0 + + + + + + + +-----+ PANEL 0 + TEXT PANEL #0 + + + \ +-----+ /\ + GRAPHICS PANEL #1 + + + + + + + +-----+ PANEL 1 + TEXT PANEL #1 + + + +-----+ \ </pre>
Parameters	<ul style="list-style-type: none"> - <code>width</code>: width of the Glcd panel - <code>height</code>: height of the Glcd panel - <code>fntW</code>: font width
Returns	Nothing.
Requires	<p>Global variables :</p> <ul style="list-style-type: none"> - <code>T6963C_dataPort</code>: Data Port - <code>T6963C_ctrlwr</code>: Write signal pin - <code>T6963C_ctrlrd</code>: Read signal pin - <code>T6963C_ctrlcd</code>: Command/Data signal pin - <code>T6963C_ctrlrst</code>: Reset signal pin - <code>T6963C_ctrlwr_Direction</code>: Direction of Write signal pin - <code>T6963C_ctrlrd_Direction</code>: Direction of Read signal pin - <code>T6963C_ctrlcd_Direction</code>: Direction of Command/Data signal pin - <code>T6963C_ctrlrst_Direction</code>: Direction of Reset signal pin <p>must be defined before using this function.</p>

Example	<pre>// T6963C module connections char T6963C_dataPort at PORTB; // DATA port sbit T6963C_ctrlwr at LATF2_bit; // WR write signal sbit T6963C_ctrlrd at LATF1_bit; // RD read signal sbit T6963C_ctrlcd at LATF0_bit; // CD command/data signal sbit T6963C_ctrlrst at LATF4_bit; // RST reset signal sbit T6963C_ctrlwr_Direction at TRISF2_bit; // WR write signal sbit T6963C_ctrlrd_Direction at TRISF1_bit; // RD read signal sbit T6963C_ctrlcd_Direction at TRISF0_bit; // CD command/data signal sbit T6963C_ctrlrst_Direction at TRISF4_bit; // RST reset signal // Signals not used by library, they are set in main function sbit T6963C_ctrlce at LATF3_bit; // CE signal sbit T6963C_ctrlfs at LATF6_bit; // FS signal sbit T6963C_ctrlmd at LATF5_bit; // MD signal sbit T6963C_ctrlce_Direction at TRISF3_bit; // CE signal direction sbit T6963C_ctrlfs_Direction at TRISF6_bit; // FS signal direction sbit T6963C_ctrlmd_Direction at TRISF5_bit; // MD signal direction // End T6963C module connections ... // init display for 240 pixel width, 128 pixel height and 8 bits character width T6963C_init(240, 128, 8);</pre>
Notes	None.

T6963C_writeData

Prototype	<code>void T6963C_writeData(unsigned char mydata);</code>
Description	Writes data to T6963C controller.
Parameters	- <code>mydata</code> : data to be written
Returns	Nothing.
Requires	Toshiba Glcd module needs to be initialized. See the T6963C_init routine.
Example	<code>T6963C_writeData(AddrL);</code>
Notes	None.

T6963C_writeCommand

Prototype	<code>void T6963C_writeCommand(unsigned char mydata);</code>
Description	Writes command to T6963C controller.
Parameters	- <code>mydata</code> : command to be written
Returns	Nothing.
Requires	Toshiba Glcd module needs to be initialized. See the T6963C_init routine.
Example	<code>T6963C_writeCommand(T6963C_CURSOR_POINTER_SET);</code>
Notes	None.

T6963C_setPtr

Prototype	<code>void T6963C_setPtr(unsigned int p, unsigned char c);</code>
Description	Sets the memory pointer p for command p.
Parameters	- <code>p</code> : address where command should be written - <code>c</code> : command to be written
Returns	Nothing.
Requires	Toshiba Glcd module needs to be initialized. See the T6963C_init routine.
Example	<code>T6963C_setPtr(T6963C_grHomeAddr + start, T6963C_ADDRESS_POINTER_SET);</code>
Notes	None.

T6963C_waitReady

Prototype	<code>void T6963C_waitReady();</code>
Description	Pools the status byte, and loops until Toshiba Glcd module is ready.
Parameters	None.
Returns	Nothing.
Requires	Toshiba Glcd module needs to be initialized. See the T6963C_init routine.
Example	<code>T6963C_waitReady();</code>
Notes	None.

T6963C_fill

Prototype	<code>void T6963C_fill(unsigned char v, unsigned int start, unsigned int len);</code>
Description	Fills controller memory block with given byte.
Parameters	- <code>v</code> : byte to be written - <code>start</code> : starting address of the memory block - <code>len</code> : length of the memory block in bytes
Returns	Nothing.
Requires	Toshiba Glcd module needs to be initialized. See the T6963C_init routine.
Example	<code>T6963C_fill(0x33, 0x00FF, 0x000F);</code>
Notes	None.

T6963C_dot

Prototype	<code>void T6963C_dot(int x, int y, unsigned char color);</code>
Description	Draws a dot in the current graphic panel of Glcd at coordinates (x, y).
Parameters	- <code>x</code> : dot position on x-axis - <code>y</code> : dot position on y-axis - <code>color</code> : color parameter. Valid values: T6963C_BLACK and T6963C_WHITE
Returns	Nothing.
Requires	Toshiba Glcd module needs to be initialized. See the T6963C_init routine.
Example	<code>T6963C_dot(x0, y0, pcolor);</code>
Notes	None.

T6963C_write_char

Prototype	<code>void T6963C_write_char(unsigned char c, unsigned char x, unsigned char y, unsigned char mode);</code>
Description	Writes a char in the current text panel of Glcd at coordinates (x, y).
Parameters	<ul style="list-style-type: none"> - <code>c</code>: char to be written - <code>x</code>: char position on x-axis - <code>y</code>: char position on y-axis - <code>mode</code>: mode parameter. Valid values: T6963C_ROM_MODE_OR, T6963C_ROM_MODE_XOR, T6963C_ROM_MODE_AND and T6963C_ROM_MODE_TEXT <p>Mode parameter explanation:</p> <ul style="list-style-type: none"> - OR Mode: In the OR-Mode, text and graphics can be displayed and the data is logically “OR-ed”. This is the most common way of combining text and graphics for example labels on buttons. - XOR-Mode: In this mode, the text and graphics data are combined via the logical “exclusive OR”. This can be useful to display text in the negative mode, i.e. white text on black background. - AND-Mode: The text and graphic data shown on display are combined via the logical “AND function”. - TEXT-Mode: This option is only available when displaying just a text. The Text Attribute values are stored in the graphic area of display memory. <p>For more details see the T6963C datasheet.</p>
Returns	Nothing.
Requires	Toshiba Glcd module needs to be initialized. See the T6963C_init routine.
Example	<code>T6963C_write_char('A', 22, 23, T6963C_ROM_MODE_AND);</code>
Notes	None.

T6963C_write_text

Prototype	<code>void T6963C_write_text(unsigned char *str, unsigned char x, unsigned char y, unsigned char mode);</code>
Description	Writes text in the current text panel of Glcd at coordinates (x, y).
Parameters	<ul style="list-style-type: none"> - <code>str</code>: text to be written - <code>x</code>: text position on x-axis - <code>y</code>: text position on y-axis - <code>mode</code>: mode parameter. Valid values: T6963C_ROM_MODE_OR, T6963C_ROM_MODE_XOR, T6963C_ROM_MODE_AND and T6963C_ROM_MODE_TEXT <p>Mode parameter explanation:</p> <ul style="list-style-type: none"> - OR Mode: In the OR-Mode, text and graphics can be displayed and the data is logically "OR-ed". This is the most common way of combining text and graphics for example labels on buttons. - XOR-Mode: In this mode, the text and graphics data are combined via the logical "exclusive OR". This can be useful to display text in the negative mode, i.e. white text on black background. - AND-Mode: The text and graphic data shown on display are combined via the logical "AND function". - TEXT-Mode: This option is only available when displaying just a text. The Text Attribute values are stored in the graphic area of display memory. <p>For more details see the T6963C datasheet.</p>
Returns	Nothing.
Requires	Toshiba Glcd module needs to be initialized. See the T6963C_init routine.
Example	<code>T6963C_write_text("Glcd LIBRARY DEMO, WELCOME !", 0, 0, T6963C_ROM_MODE_XOR);</code>
Notes	None.

T6963C_line

Prototype	<code>void T6963C_line(int x0, int y0, int x1, int y1, unsigned char pcolor);</code>
Description	Draws a line from (x0, y0) to (x1, y1).
Parameters	<ul style="list-style-type: none"> - <code>x0</code>: x coordinate of the line start - <code>y0</code>: y coordinate of the line end - <code>x1</code>: x coordinate of the line start - <code>y1</code>: y coordinate of the line end - <code>pcolor</code>: color parameter. Valid values: T6963C_BLACK and T6963C_WHITE
Returns	Nothing.
Requires	Toshiba Glcd module needs to be initialized. See the T6963C_init routine.
Example	<code>T6963C_line(0, 0, 239, 127, T6963C_WHITE);</code>
Notes	None.

T6963C_rectangle

Prototype	<code>void T6963C_rectangle(int x0, int y0, int x1, int y1, unsigned char pcolor);</code>
Description	Draws a rectangle on Glcd.
Parameters	- <code>x0</code> : x coordinate of the upper left rectangle corner - <code>y0</code> : y coordinate of the upper left rectangle corner - <code>x1</code> : x coordinate of the lower right rectangle corner - <code>y1</code> : y coordinate of the lower right rectangle corner - <code>pcolor</code> : color parameter. Valid values: T6963C_BLACK and T6963C_WHITE
Returns	Nothing.
Requires	Toshiba Glcd module needs to be initialized. See the T6963C_init routine.
Example	<code>T6963C_rectangle(20, 20, 219, 107, T6963C_WHITE);</code>
Notes	None.

T6963C_rectangle_round_edges

Prototype	<code>void T6963C_rectangle_round_edges(int x0, int y0, int x1, int y1, int round_radius, unsigned char pcolor);</code>
Description	Draws a rounded edge rectangle on Glcd.
Parameters	- <code>x0</code> : x coordinate of the upper left rectangle corner - <code>y0</code> : y coordinate of the upper left rectangle corner - <code>x1</code> : x coordinate of the lower right rectangle corner - <code>y1</code> : y coordinate of the lower right rectangle corner - <code>round_radius</code> : radius of the rounded edge. - <code>pcolor</code> : color parameter. Valid values: T6963C_BLACK and T6963C_WHITE
Returns	Nothing.
Requires	Toshiba Glcd module needs to be initialized. See the T6963C_init routine.
Example	<code>T6963C_rectangle_round_edges(20, 20, 219, 107, 12, T6963C_WHITE);</code>
Notes	None.

T6963C_rectangle_round_edges_fill

Prototype	<code>void T6963C_rectangle_round_edges_fill(int x0, int y0, int x1, int y1, int round_radius, unsigned char pcolor);</code>
Description	Draws a filled rounded edge rectangle on Glcd.
Parameters	<ul style="list-style-type: none"> - <code>x0</code>: x coordinate of the upper left rectangle corner - <code>y0</code>: y coordinate of the upper left rectangle corner - <code>x1</code>: x coordinate of the lower right rectangle corner - <code>y1</code>: y coordinate of the lower right rectangle corner - <code>round_radius</code>: radius of the rounded edge - <code>pcolor</code>: color parameter. Valid values: <code>T6963C_BLACK</code> and <code>T6963C_WHITE</code>
Returns	Nothing.
Requires	Toshiba Glcd module needs to be initialized. See the <code>T6963C_init</code> routine.
Example	<code>T6963C_rectangle_round_edges_fill(20, 20, 219, 107, 12, T6963C_WHITE);</code>
Notes	None.

T6963C_box

Prototype	<code>void T6963C_box(int x0, int y0, int x1, int y1, unsigned char pcolor);</code>
Description	Draws a box on Glcd
Parameters	<ul style="list-style-type: none"> - <code>x0</code>: x coordinate of the upper left box corner - <code>y0</code>: y coordinate of the upper left box corner - <code>x1</code>: x coordinate of the lower right box corner - <code>y1</code>: y coordinate of the lower right box corner - <code>pcolor</code>: color parameter. Valid values: <code>T6963C_BLACK</code> and <code>T6963C_WHITE</code>
Returns	Nothing.
Requires	Toshiba Glcd module needs to be initialized. See the <code>T6963C_init</code> routine.
Example	<code>T6963C_box(0, 119, 239, 127, T6963C_WHITE);</code>
Notes	None.

T6963C_circle

Prototype	<code>void T6963C_circle(int x, int y, long r, unsigned char pcolor);</code>
Description	Draws a circle on Glcd.
Parameters	<ul style="list-style-type: none"> - <code>x</code>: x coordinate of the circle center - <code>y</code>: y coordinate of the circle center - <code>r</code>: radius size - <code>pcolor</code>: color parameter. Valid values: <code>T6963C_BLACK</code> and <code>T6963C_WHITE</code>
Returns	Nothing.
Requires	Toshiba Glcd module needs to be initialized. See the <code>T6963C_init</code> routine.
Example	<code>T6963C_circle(0, 119, 239, 127, T6963C_WHITE);</code>
Notes	None.

T6963C_circle_fill

Prototype	<code>void T6963C_circle_fill(int x, int y, long r, unsigned char pcolor);</code>
Description	Draws a filled circle on Glcd.
Parameters	- <code>x</code> : x coordinate of the circle center - <code>y</code> : y coordinate of the circle center - <code>r</code> : radius size - <code>pcolor</code> : color parameter. Valid values: T6963C_BLACK and T6963C_WHITE
Returns	Nothing.
Requires	Toshiba Glcd module needs to be initialized. See the T6963C_init routine.
Example	<code>T6963C_circle_fill(120, 64, 110, T6963C_WHITE);</code>
Notes	None.

T6963C_image

Prototype	<code>void T6963C_image(const code char *pic);</code>
Description	Displays bitmap on Glcd.
Parameters	- <code>pic</code> : image to be displayed. Bitmap array can be located in both code and RAM memory (due to the mikroC PRO for dsPIC30/33 and PIC24 pointer to const and pointer to RAM equivalency).
Returns	Nothing.
Requires	Toshiba Glcd module needs to be initialized. See the T6963C_init routine.
Example	<code>T6963C_image(my_image);</code>
Notes	Image dimension must match the display dimension. Use the integrated Glcd Bitmap Editor (menu option Tools > Glcd Bitmap Editor) to convert image to a constant array suitable for displaying on Glcd.

T6963C_PartialImage

Prototype	<code>void T6963C_PartialImage(unsigned int x_left, unsigned int y_top, unsigned int width, unsigned int height, unsigned int picture_width, unsigned int picture_height, code const unsigned short * image);</code>
Description	Displays a partial area of the image on a desired location.
Parameters	<ul style="list-style-type: none"> - <code>x_left</code>: x coordinate of the desired location (upper left coordinate). - <code>y_top</code>: y coordinate of the desired location (upper left coordinate). - <code>width</code>: desired image width. - <code>height</code>: desired image height. - <code>picture_width</code>: width of the original image. - <code>picture_height</code>: height of the original image. - <code>image</code>: image to be displayed. Bitmap array can be located in both code and RAM memory (due to the mikroC PRO for PIC pointer to const and pointer to RAM equivalency).
Returns	Nothing.
Requires	Toshiba Glcd module needs to be initialized. See T6963C_init routine.
Example	<pre>// Draws a 10x15 part of the image starting from the upper left corner on the coordinate (10,12). Original image size is 16x32. T6963C_PartialImage(10, 12, 10, 15, 16, 32, image);</pre>
Notes	<p>Image dimension must match the display dimension.</p> <p>Use the integrated Glcd Bitmap Editor (menu option Tools > Glcd Bitmap Editor) to convert image to a constant array suitable for displaying on Glcd.</p>

T6963C_sprite

Prototype	<code>void T6963C_sprite(unsigned char px, unsigned char py, const code char *pic, unsigned char sx, unsigned char sy);</code>
Description	Fills graphic rectangle area (px, py) to (px+sx, py+sy) with custom size picture.
Parameters	<ul style="list-style-type: none"> - <code>px</code>: x coordinate of the upper left picture corner. Valid values: multiples of the font width - <code>py</code>: y coordinate of the upper left picture corner - <code>pic</code>: picture to be displayed - <code>sx</code>: picture width. Valid values: multiples of the font width - <code>sy</code>: picture height
Returns	Nothing.
Requires	Toshiba Glcd module needs to be initialized. See the T6963C_init routine.
Example	<pre>T6963C_sprite(76, 4, einstein, 88, 119); // draw a sprite</pre>
Notes	If px and sx parameters are not multiples of the font width they will be scaled to the nearest lower number that is a multiple of the font width.

T6963C_set_cursor

Prototype	<code>void T6963C_set_cursor(unsigned char x, unsigned char y);</code>
Description	Sets cursor to row x and column y.
Parameters	- x: cursor position row number - y: cursor position column number
Returns	Nothing.
Requires	Toshiba Glcd module needs to be initialized. See the T6963C_init routine.
Example	<code>T6963C_set_cursor(cposx, cposy);</code>
Notes	None.

T6963C_clearBit

Prototype	<code>void T6963C_clearBit(unsigned int b);</code>
Description	Clears control port bit(s).
Parameters	- b: bit mask. The function will clear bit x on control port if bit x in bit mask is set to 1.
Returns	Nothing.
Requires	Toshiba Glcd module needs to be initialized. See the T6963C_init routine.
Example	<code>// clear bits 0 and 1 on control port T6963C_clearBit(0x0003);</code>
Notes	None.

T6963C_setBit

Prototype	<code>void T6963C_setBit(unsigned int b);</code>
Description	Sets control port bit(s).
Parameters	- b: bit mask. The function will set bit x on control port if bit x in bit mask is set to 1.
Returns	Nothing.
Requires	Toshiba Glcd module needs to be initialized. See the T6963C_init routine.
Example	<code>// set bits 0 and 1 on control port T6963C_setBit(0x0003);</code>
Notes	None.

T6963C_negBit

Prototype	<code>void T6963C_negBit(unsigned int b);</code>
Description	Negates control port bit(s).
Parameters	- b : bit mask. The function will negate bit x on control port if bit x in bit mask is set to 1.
Returns	Nothing.
Requires	Toshiba Glcd module needs to be initialized. See the T6963C_init routine.
Example	<pre>// negate bits 0 and 1 on control port T6963C_negBit(0x0003);</pre>
Notes	None.

T6963C_displayGrPanel

Prototype	<code>void T6963C_displayGrPanel(unsigned int n);</code>
Description	Display selected graphic panel.
Parameters	- n : graphic panel number. Valid values: 0 and 1.
Returns	Nothing.
Requires	Toshiba Glcd module needs to be initialized. See the T6963C_init routine.
Example	<pre>// display graphic panel 1 T6963C_displayGrPanel(1);</pre>
Notes	None.

T6963C_displayTxtPanel

Prototype	<code>void T6963C_displayTxtPanel(unsigned int n);</code>
Description	Display selected text panel.
Parameters	- n : text panel number. Valid values: 0 and 1.
Returns	Nothing.
Requires	Toshiba Glcd module needs to be initialized. See the T6963C_init routine.
Example	<pre>// display text panel 1 T6963C_displayTxtPanel(1);</pre>
Notes	None.

T6963C_setGrPanel

Prototype	<code>void T6963C_setGrPanel(unsigned int n);</code>
Description	Compute start address for selected graphic panel and set appropriate internal pointers. All subsequent graphic operations will be preformed at this graphic panel.
Parameters	- <i>n</i> : graphic panel number. Valid values: 0 and 1.
Returns	Nothing.
Requires	Toshiba Glcd module needs to be initialized. See the T6963C_init routine.
Example	<pre>// set graphic panel 1 as current graphic panel. T6963C_setGrPanel(1);</pre>
Notes	None.

T6963C_setTxtPanel

Prototype	<code>void T6963C_setTxtPanel(unsigned int n);</code>
Description	Compute start address for selected text panel and set appropriate internal pointers. All subsequent text operations will be preformed at this text panel.
Parameters	- <i>n</i> : text panel number. Valid values: 0 and 1.
Returns	Nothing.
Requires	Toshiba Glcd module needs to be initialized. See the T6963C_init routine.
Example	<pre>// set text panel 1 as current text panel. T6963C_setTxtPanel(1);</pre>
Notes	None.

T6963C_panelFill

Prototype	<code>void T6963C_panelFill(unsigned char v);</code>
Description	Fill current panel in full (graphic+text) with appropriate value (0 to clear).
Parameters	- <i>v</i> : value to fill panel with.
Returns	Nothing.
Requires	Toshiba Glcd module needs to be initialized. See the T6963C_init routine.
Example	<pre>clear current panel T6963C_panelFill(0);</pre>
Notes	None.

T6963C_grFill

Prototype	<code>void T6963C_grFill(unsigned char v);</code>
Description	Fill current graphic panel with appropriate value (0 to clear).
Parameters	- <code>v</code> : value to fill graphic panel with.
Returns	Nothing.
Requires	Toshiba Glcd module needs to be initialized. See the T6963C_init routine.
Example	<pre>// clear current graphic panel T6963C_grFill(0);</pre>
Notes	None.

T6963C_txtFill

Prototype	<code>void T6963C_txtFill(unsigned char v);</code>
Description	Fill current text panel with appropriate value (0 to clear).
Parameters	- <code>v</code> : this value increased by 32 will be used to fill text panel.
Returns	Nothing.
Requires	Toshiba Glcd module needs to be initialized. See the T6963C_init routine.
Example	<pre>// clear current text panel T6963C_txtFill(0);</pre>
Notes	None.

T6963C_cursor_height

Prototype	<code>void T6963C_cursor_height(unsigned char n);</code>
Description	Set cursor size.
Parameters	- <code>n</code> : cursor height. Valid values: 0..7.
Returns	Nothing.
Requires	Toshiba Glcd module needs to be initialized. See the T6963C_init routine.
Example	<pre>T6963C_cursor_height(7);</pre>
Notes	None.

T6963C_graphics

Prototype	<code>void T6963C_graphics(unsigned int n);</code>
Description	Enable/disable graphic displaying.
Parameters	- <code>n</code> : graphic enable/disable parameter. Valid values: <code>0</code> (disable graphic displaying) and <code>1</code> (enable graphic displaying).
Returns	Nothing.
Requires	Toshiba Glcd module needs to be initialized. See the T6963C_init routine.
Example	<pre>// enable graphic displaying T6963C_graphics(1);</pre>
Notes	None.

T6963C_text

Prototype	<code>void T6963C_text(unsigned int n);</code>
Description	Enable/disable text displaying.
Parameters	- <code>n</code> : on/off parameter. Valid values: <code>0</code> (disable text displaying) and <code>1</code> (enable text displaying).
Returns	Nothing.
Requires	Toshiba Glcd module needs to be initialized. See the T6963C_init routine.
Example	<pre>// enable text displaying T6963C_text(1);</pre>
Notes	None.

T6963C_cursor

Prototype	<code>void T6963C_cursor(unsigned int n);</code>
Description	Set cursor on/off.
Parameters	- <code>n</code> : on/off parameter. Valid values: <code>0</code> (set cursor off) and <code>1</code> (set cursor on).
Returns	Nothing.
Requires	Toshiba Glcd module needs to be initialized. See the T6963C_init routine.
Example	<pre>// set cursor on T6963C_cursor(1);</pre>
Notes	None.

T6963C_cursor_blink

Prototype	<code>void T6963C_cursor_blink(unsigned int n);</code>
Description	Enable/disable cursor blinking.
Parameters	- n: cursor blinking enable/disable parameter. Valid values: 0 (disable cursor blinking) and 1 (enable cursor blinking).
Returns	Nothing.
Requires	Toshiba Glcd module needs to be initialized. See the T6963C_init routine.
Example	<pre>// enable cursor blinking T6963C_cursor_blink(1);</pre>
Notes	None.

Library Example

The following drawing demo tests advanced routines of the T6963C Glcd library. Hardware configurations in this example are made for the dsPICPRO2 board and dsPIC30F6014A.

Copy Code To Clipboard

```
#include      "__T6963C.h"

// T6963C module connections
char T6963C_dataPort at PORTB;           // DATA port

sbit T6963C_ctrlwr at LATF2_bit;        // WR write signal
sbit T6963C_ctrlrd at LATF1_bit;        // RD read signal
sbit T6963C_ctrlcd at LATF0_bit;        // CD command/data signal
sbit T6963C_ctrlrst at LATF4_bit;       // RST reset signal
sbit T6963C_ctrlwr_Direction at TRISF2_bit; // WR write signal
sbit T6963C_ctrlrd_Direction at TRISF1_bit; // RD read signal
sbit T6963C_ctrlcd_Direction at TRISF0_bit; // CD command/data signal
sbit T6963C_ctrlrst_Direction at TRISF4_bit; // RST reset signal

// Signals not used by library, they are set in main function
sbit T6963C_ctrlce at LATF3_bit;        // CE signal
sbit T6963C_ctrlfs at LATF6_bit;        // FS signal
sbit T6963C_ctrlmd at LATF5_bit;        // MD signal
sbit T6963C_ctrlce_Direction at TRISF3_bit; // CE signal direction
sbit T6963C_ctrlfs_Direction at TRISF6_bit; // FS signal direction
sbit T6963C_ctrlmd_Direction at TRISF5_bit; // MD signal direction

// End T6963C module connections

/*
 * bitmap pictures stored in ROM
 */
const code char mikroE_240x128_bmp[];
const code char einstein[];
```

```
void main() {
char txt1[] = " EINSTEIN WOULD HAVE LIKED mE";
char txt[] = " GLCD LIBRARY DEMO, WELCOME !";

unsigned char panel;           // Current panel
unsigned int i;                // General purpose register
unsigned char curs;           // Cursor visibility
unsigned int cposx, cposy;     // Cursor x-y position

#define COMPLETE_EXAMPLE      // comment this line to make simpler/smaller example

ADPCFG = 0xFFFF;              // Configure AN pins as digital

TRISB8_bit = 1;                // Set RF0 as input
TRISB9_bit = 1;                // Set RF1 as input
TRISB10_bit = 1;               // Set RF2 as input
TRISB11_bit = 1;              // Set RF3 as input
TRISB12_bit = 1;              // Set RF4 as input

T6963C_ctrlce_Direction = 0;
T6963C_ctrlce = 0;             // Enable T6963C
T6963C_ctrlfs_Direction = 0;
T6963C_ctrlfs = 0;            // Font Select 8x8
T6963C_ctrlmd_Direction = 0;
T6963C_ctrlmd = 0;            // Column number select

// Initialize T6963C
T6963C_init(240, 128, 8);

/*
 * Enable both graphics and text display at the same time
 */
T6963C_graphics(1);
T6963C_text(1);

panel = 0;
i = 0;
curs = 0;
cposx = cposy = 0;
/*
 * Text messages
 */
T6963C_write_text(txt, 0, 0, T6963C_ROM_MODE_XOR);
T6963C_write_text(txt1, 0, 15, T6963C_ROM_MODE_XOR);

/*
 * Cursor
 */
T6963C_cursor_height(8);      // 8 pixel height
T6963C_set_cursor(0, 0);     // Move cursor to top left
T6963C_cursor(0);            // Cursor off
```

```

/*
 * Draw rectangles
 */
T6963C_rectangle(0, 0, 239, 127, T6963C_WHITE);
T6963C_rectangle(20, 20, 219, 107, T6963C_WHITE);
T6963C_rectangle(40, 40, 199, 87, T6963C_WHITE);
T6963C_rectangle(60, 60, 179, 67, T6963C_WHITE);

/*
 * Draw a cross
 */
T6963C_line(0, 0, 239, 127, T6963C_WHITE);
T6963C_line(0, 127, 239, 0, T6963C_WHITE);

/*
 * Draw solid boxes
 */
T6963C_box(0, 0, 239, 8, T6963C_WHITE);
T6963C_box(0, 119, 239, 127, T6963C_WHITE);

#ifdef COMPLETE_EXAMPLE
/*
 * Draw circles
 */
T6963C_circle(120, 64, 10, T6963C_WHITE);
T6963C_circle(120, 64, 30, T6963C_WHITE);
T6963C_circle(120, 64, 50, T6963C_WHITE);
T6963C_circle(120, 64, 70, T6963C_WHITE);
T6963C_circle(120, 64, 90, T6963C_WHITE);
T6963C_circle(120, 64, 110, T6963C_WHITE);
T6963C_circle(120, 64, 130, T6963C_WHITE);

T6963C_sprite(76, 4, einstein, 88, 119);           // Draw a sprite

T6963C_setGrPanel(1);                             // Select other graphic panel

T6963C_image(mikroE_240x128_bmp);                 // Draw an image

#endif

for(;;) {                                         // Endless loop
/*
 * If RF0 is pressed, display only graphic panel
 */
if(RB8_bit) {
    T6963C_graphics(1);
    T6963C_text(0);
    Delay_ms(300);
}
#ifdef COMPLETE_EXAMPLE

```

```
1      /*
      * If RF1 is pressed, toggle the display between graphic panel 0 and graphic panel
      */
      else if(RB9_bit) {
          panel++;
          panel &= 1;
          T6963C_displayGrPanel(panel);
          Delay_ms(300);
      }
#endif
/*
* If RF2 is pressed, display only text panel
*/
else if(RB10_bit) {
    T6963C_graphics(0);
    T6963C_text(1);
    Delay_ms(300);
}

/*
* If RF3 is pressed, display text and graphic panels
*/
else if(RB11_bit) {
    T6963C_graphics(1);
    T6963C_text(1);
    Delay_ms(300);
}

/*
* If RF4 is pressed, change cursor
*/
else if(RB12_bit) {
    curs++;
    if(curs == 3) curs = 0;
    switch(curs) {
        case 0:
            // no cursor
            T6963C_cursor(0);
            break;
        case 1:
            // blinking cursor
            T6963C_cursor(1);
            T6963C_cursor_blink(1);
            break;
        case 2:
            // non blinking cursor
            T6963C_cursor(1);
            T6963C_cursor_blink(0);
            break;
    }
    Delay_ms(300);
}
```

```

/*
 * Move cursor, even if not visible
 */
cposx++;
if(cposx == T6963C_txtCols) {
    cposx = 0;
    cposy++;
    if(cposy == T6963C_grHeight / T6963C_CHARACTER_HEIGHT) {
        cposy = 0;
    }
}
T6963C_set_cursor(cposx, cposy);

Delay_ms(100);
}

```

HW Connection

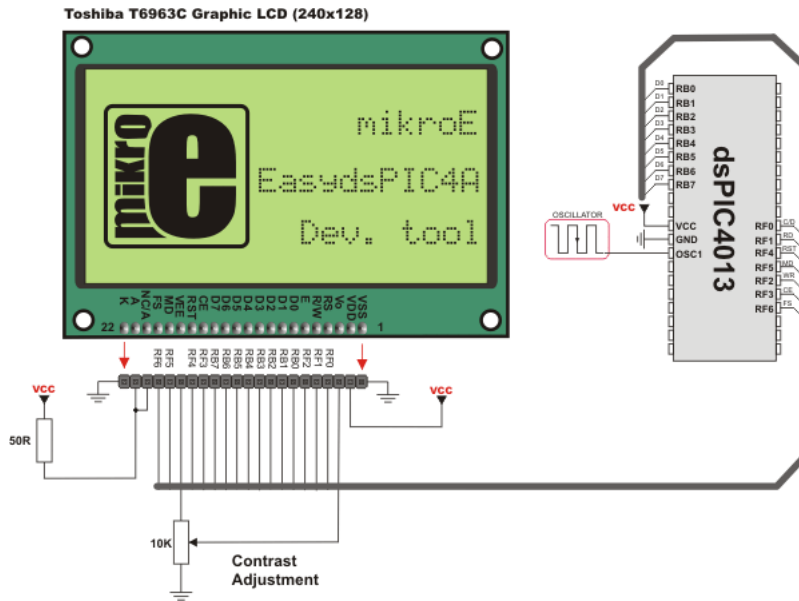

T6963C Glcd HW connection

TFT Library

Thin film transistor liquid crystal display (TFT-LCD) is a variant of liquid crystal display (LCD) which uses thin-film transistor (TFT) technology to improve image quality (e.g., addressability, contrast).

TFT LCD is one type of active matrix LCD, though all LCD-screens are based on TFT active matrix addressing.

TFT LCDs are used in television sets, computer monitors, mobile phones, handheld video game systems, personal digital assistants, navigation systems, projectors, etc.

The mikroC PRO for dsPIC30/33 and PIC24 provides a library for working with HX8347-D 320x240 TFT Lcd controller. The HX8347-D is designed to provide a single-chip solution that combines a gate driver, a source driver, power supply circuit for 262,144 colors to drive a TFT panel with 320x240 dots at maximum.

The HX8347-D is suitable for any small portable battery-driven and long-term driving products, such as small PDAs, digital cellular phones and bi-directional pagers.

External dependencies of TFT Library

The following variables must be defined in all projects using TFT library:	Description :	Example :
<code>extern sfr char TFT_DataPort;</code>	TFT Data Port.	<code>char TFT_DataPort at LATE;</code>
<code>extern sfr char TFT_DataPort_Direction;</code>	Direction of the TFT Data Port.	<code>char TFT_DataPort_Direction at TRISE;</code>
<code>extern sfr sbit TFT_WR;</code>	Write signal.	<code>sbit TFT_WR at LATD13_bit;</code>
<code>extern sfr sbit TFT_RD;</code>	Read signal.	<code>sbit TFT_RD at LATD12_bit;</code>
<code>extern sfr sbit TFT_CS;</code>	Chip Select signal.	<code>sbit TFT_CS at LATIC3_bit;</code>
<code>extern sfr sbit TFT_RS;</code>	Command/Register Select signal.	<code>sbit TFT_RS at LATB15_bit;</code>
<code>extern sfr sbit TFT_RST;</code>	Reset signal.	<code>sbit TFT_RST at LATIC1_bit;</code>
<code>extern sfr sbit TFT_WR_Direction;</code>	Direction of the Write pin.	<code>sbit TFT_WR_Direction at TRISD13_bit;</code>
<code>extern sfr sbit TFT_RD_Direction;</code>	Direction of the Read pin.	<code>sbit TFT_RD_Direction at TRISD12_bit;</code>
<code>extern sfr sbit TFT_CS_Direction;</code>	Direction of the Chip Select pin.	<code>sbit TFT_CS_Direction at TRISC3_bit;</code>
<code>extern sfr sbit TFT_RS_Direction;</code>	Direction of the Register Select pin.	<code>sbit TFT_RS_Direction at TRISB13_bit;</code>
<code>extern sfr sbit TFT_RST_Direction;</code>	Direction of the Reset pin.	<code>sbitTFT_RST_Direction at TRISC1_bit;</code>

Library Routines

- TFT_Init
- TFT_Set_Index
- TFT_Write_Command
- TFT_Write_Data
- TFT_Set_Active
- TFT_Set_Font
- TFT_Write_Char
- TFT_Write_Text
- TFT_Fill_Screen
- TFT_Set_Pen
- TFT_Set_Brush
- TFT_Dot
- TFT_Line
- TFT_H_Line
- TFT_V_Line
- TFT_Rectangle
- TFT_Rectangle_Round_Edges
- TFT_Circle
- TFT_Image
- TFT_PartialImage
- TFT_Image_Jpeg
- TFT_RGBToColor16bit
- TFT_Color16bitToRGB

TFT_Init

Prototype	<code>void TFT_Init(unsigned int display_width, unsigned char display_height);</code>
Returns	Nothing
Description	<p>Initializes TFT display in the 8-bit working mode.</p> <p>Parameters :</p> <ul style="list-style-type: none"> - <code>width</code>: width of the TFT panel - <code>height</code>: height of the TFT panel
Requires	<p>Global variables :</p> <ul style="list-style-type: none"> - <code>TFT_DataPort</code>: Data Port - <code>TFT_WR</code>: Write signal pin - <code>TFT_RD</code>: Read signal pin - <code>TFT_CS</code>: Chip Select signal pin - <code>TFT_RS</code>: Register Select signal pin - <code>TFT_RST</code>: Reset signal pin - <code>TFT_DataPort_Direction</code>: Direction of Data Port - <code>TFT_WR_Direction</code>: Direction of Write signal pin - <code>TFT_RD_Direction</code>: Direction of Read signal pin - <code>TFT_CS_Direction</code>: Direction of Chip Select signal pin - <code>TFT_RS_Direction</code>: Direction of Register Select signal pin - <code>TFT_RST_Direction</code>: Direction of Reset signal pin <p>must be defined before using this function.</p>
Example	<pre>// TFT display connections char TFT_DataPort at LATE; sbit TFT_WR at LATD13_bit; sbit TFT_RD at LATD12_bit; sbit TFT_CS at LATC3_bit; sbit TFT_RS at LATB15_bit; sbit TFT_RST at LATC1_bit; char TFT_DataPort_Direction at TRISE; sbit TFT_WR_Direction : at TRISD13_bit; sbit TFT_RD_Direction at TRISD12_bit; sbit TFT_CS_Direction at TRISC3_bit; sbit TFT_RS_Direction at TRISB15_bit; sbit TFT_RST_Direction at TRISC1_bit; // End of TFT display connections // Initialize 240x320 TFT display TFT_Init(240, 320);</pre>

TFT_Set_Index

Prototype	<code>void TFT_Set_Index(unsigned short index);</code>
Returns	Nothing
Description	<p>Accesses register space of the controller and sets the desired register.</p> <p>Parameters :</p> <p>- <code>index</code>: desired register number.</p>
Requires	TFT module needs to be initialized. See the TFT_Init routine.
Example	<pre>// Access register at the location 0x02 TFT_Set_Index(0x02);</pre>

TFT_Write_Command

Prototype	<code>void TFT_Write_Command(unsigned short cmd);</code>
Returns	Nothing
Description	<p>Accesses data space and writes a command.</p> <p>Parameters :</p> <p>- <code>cmd</code>: command to be written.</p>
Requires	TFT module needs to be initialized. See the TFT_Init routine.
Example	<pre>// Write a command TFT_Write_Command(0x02);</pre>

TFT_Write_Data

Prototype	<code>void TFT_Write_Data(unsigned int _data);</code>
Returns	Nothing
Description	<p>Writes data into display memory.</p> <p>Parameters :</p> <p>- <code>_data</code>: data to be written.</p>
Requires	TFT module needs to be initialized. See the TFT_Init routine.
Example	<pre>// Send data TFT_Write_Data(0x02);</pre>

TFT_Set_Active

Prototype	<code>void TFT_Set_Active(void (*Set_Index_Ptr)(unsigned short), void (*Write_Command_Ptr)(unsigned short), void (*Write_Data_Ptr)(unsigned int));</code>
Returns	Nothing
Description	<p>This function sets appropriate pointers to a user-defined basic routines in order to enable multiple working modes.</p> <p>Parameters :</p> <ul style="list-style-type: none"> - <code>Set_Index_Ptr</code>: Set_Index handler. - <code>Write_Command_Ptr</code>: Write_Command handler. - <code>Write_Data_Ptr</code>: Write_Data handler.
Requires	None.
Example	<pre>// Example of establishing 16-bit communication between TFT display and PORTD, PORTE of MCU : void Set_Index(unsigned short index) { TFT_RS = 0; Lo(LATD) = index; TFT_WR = 0; TFT_WR = 1; } void Write_Command(unsigned short cmd) { TFT_RS = 1; Lo(LATD) = cmd; TFT_WR = 0; TFT_WR = 1; } void Write_Data(unsigned int _data) { TFT_RS = 1; Lo(LATE) = Hi(_data); Lo(LATD) = Lo(_data); TFT_WR = 0; TFT_WR = 1; } void main(){ TRISE = 0; TRISD = 0; TFT_Set_Active(Set_Index,Write_Command,Write_Data); TFT_Init(320, 240); }</pre>

TFT_Set_Font

Prototype	<code>void TFT_Set_Font(const char far *activeFont, unsigned int font_color, char font_orientation);</code>																																								
Returns	Nothing																																								
Description	<p>Sets font, its color and font orientation.</p> <p>Parameters :</p> <ul style="list-style-type: none"> - <code>activeFont</code>: desired font. Currently, only TFT_defaultFont (Tahoma14x16) is supported. - <code>font_color</code>: sets font color : <table border="1"> <thead> <tr> <th>Value</th> <th>Description</th> </tr> </thead> <tbody> <tr><td><code>CL_AQUA</code></td><td>Aqua color</td></tr> <tr><td><code>CL_BLACK</code></td><td>Black color</td></tr> <tr><td><code>CL_BLUE</code></td><td>Blue color</td></tr> <tr><td><code>CL_FUCHSIA</code></td><td>Fuchsia color</td></tr> <tr><td><code>CL_GRAY</code></td><td>Gray color</td></tr> <tr><td><code>CL_GREEN</code></td><td>Green color</td></tr> <tr><td><code>CL_LIME</code></td><td>Lime color</td></tr> <tr><td><code>CL_MAROON</code></td><td>Maroon color</td></tr> <tr><td><code>CL_NAVY</code></td><td>Navy color</td></tr> <tr><td><code>CL_OLIVE</code></td><td>Olive color</td></tr> <tr><td><code>CL_PURPLE</code></td><td>Purple color</td></tr> <tr><td><code>CL_RED</code></td><td>Red color</td></tr> <tr><td><code>CL_SILVER</code></td><td>Silver color</td></tr> <tr><td><code>CL_TEAL</code></td><td>Teal color</td></tr> <tr><td><code>CL_WHITE</code></td><td>White color</td></tr> <tr><td><code>CL_YELLOW</code></td><td>Yellow color</td></tr> </tbody> </table> <ul style="list-style-type: none"> - <code>font_orientation</code>: sets font orientation : <table border="1"> <thead> <tr> <th>Value</th> <th>Description</th> </tr> </thead> <tbody> <tr><td><code>FO_HORIZONTAL</code></td><td>Horizontal orientation</td></tr> <tr><td><code>FO_VERTICAL</code></td><td>Vertical orientation</td></tr> </tbody> </table>	Value	Description	<code>CL_AQUA</code>	Aqua color	<code>CL_BLACK</code>	Black color	<code>CL_BLUE</code>	Blue color	<code>CL_FUCHSIA</code>	Fuchsia color	<code>CL_GRAY</code>	Gray color	<code>CL_GREEN</code>	Green color	<code>CL_LIME</code>	Lime color	<code>CL_MAROON</code>	Maroon color	<code>CL_NAVY</code>	Navy color	<code>CL_OLIVE</code>	Olive color	<code>CL_PURPLE</code>	Purple color	<code>CL_RED</code>	Red color	<code>CL_SILVER</code>	Silver color	<code>CL_TEAL</code>	Teal color	<code>CL_WHITE</code>	White color	<code>CL_YELLOW</code>	Yellow color	Value	Description	<code>FO_HORIZONTAL</code>	Horizontal orientation	<code>FO_VERTICAL</code>	Vertical orientation
Value	Description																																								
<code>CL_AQUA</code>	Aqua color																																								
<code>CL_BLACK</code>	Black color																																								
<code>CL_BLUE</code>	Blue color																																								
<code>CL_FUCHSIA</code>	Fuchsia color																																								
<code>CL_GRAY</code>	Gray color																																								
<code>CL_GREEN</code>	Green color																																								
<code>CL_LIME</code>	Lime color																																								
<code>CL_MAROON</code>	Maroon color																																								
<code>CL_NAVY</code>	Navy color																																								
<code>CL_OLIVE</code>	Olive color																																								
<code>CL_PURPLE</code>	Purple color																																								
<code>CL_RED</code>	Red color																																								
<code>CL_SILVER</code>	Silver color																																								
<code>CL_TEAL</code>	Teal color																																								
<code>CL_WHITE</code>	White color																																								
<code>CL_YELLOW</code>	Yellow color																																								
Value	Description																																								
<code>FO_HORIZONTAL</code>	Horizontal orientation																																								
<code>FO_VERTICAL</code>	Vertical orientation																																								
Requires	TFT module needs to be initialized. See the TFT_Init routine.																																								
Example	<code>TFT_Set_Font(TFT_defaultFont, CL_BLACK, FO_HORIZONTAL);</code>																																								

TFT_Write_Char

Prototype	<code>void TFT_Write_Char(unsigned int c, unsigned int x, unsigned int y);</code>
Returns	Nothing.
Description	Writes a char on the TFT at coordinates (x, y). - <code>c</code> : char to be written. - <code>x</code> : char position on x-axis. - <code>y</code> : char position on y-axis.
Requires	TFT module needs to be initialized. See the TFT_Init routine.
Example	<code>TFT_Write_Char('A', 22, 23,);</code>

TFT_Write_Text

Prototype	<code>void TFT_Write_Text(unsigned char *text, unsigned int x, unsigned int y);</code>
Returns	Nothing.
Description	Writes text on the TFT at coordinates (x, y). Parameters : - <code>text</code> : text to be written. - <code>x</code> : text position on x-axis. - <code>y</code> : text position on y-axis.
Requires	TFT module needs to be initialized. See the TFT_Init routine.
Example	<code>TFT_Write_Text("TFT LIBRARY DEMO, WELCOME !", 0, 0,);</code>

TFT_Fill_Screen

Prototype	<code>void TFT_Fill_Screen(unsigned int color);</code>																																		
Returns	Nothing.																																		
Description	<p>Fills screen memory block with given color.</p> <p>Parameters :</p> <p>- <code>color</code>: color to be filled :</p> <table border="1"> <thead> <tr> <th>Value</th> <th>Description</th> </tr> </thead> <tbody> <tr> <td><code>CL_AQUA</code></td> <td>Aqua color</td> </tr> <tr> <td><code>CL_BLACK</code></td> <td>Black color</td> </tr> <tr> <td><code>CL_BLUE</code></td> <td>Blue color</td> </tr> <tr> <td><code>CL_FUCHSIA</code></td> <td>Fuchsia color</td> </tr> <tr> <td><code>CL_GRAY</code></td> <td>Gray color</td> </tr> <tr> <td><code>CL_GREEN</code></td> <td>Green color</td> </tr> <tr> <td><code>CL_LIME</code></td> <td>Lime color</td> </tr> <tr> <td><code>CL_MAROON</code></td> <td>Maroon color</td> </tr> <tr> <td><code>CL_NAVY</code></td> <td>Navy color</td> </tr> <tr> <td><code>CL_OLIVE</code></td> <td>Olive color</td> </tr> <tr> <td><code>CL_PURPLE</code></td> <td>Purple color</td> </tr> <tr> <td><code>CL_RED</code></td> <td>Red color</td> </tr> <tr> <td><code>CL_SILVER</code></td> <td>Silver color</td> </tr> <tr> <td><code>CL_TEAL</code></td> <td>Teal color</td> </tr> <tr> <td><code>CL_WHITE</code></td> <td>White color</td> </tr> <tr> <td><code>CL_YELLOW</code></td> <td>Yellow color</td> </tr> </tbody> </table>	Value	Description	<code>CL_AQUA</code>	Aqua color	<code>CL_BLACK</code>	Black color	<code>CL_BLUE</code>	Blue color	<code>CL_FUCHSIA</code>	Fuchsia color	<code>CL_GRAY</code>	Gray color	<code>CL_GREEN</code>	Green color	<code>CL_LIME</code>	Lime color	<code>CL_MAROON</code>	Maroon color	<code>CL_NAVY</code>	Navy color	<code>CL_OLIVE</code>	Olive color	<code>CL_PURPLE</code>	Purple color	<code>CL_RED</code>	Red color	<code>CL_SILVER</code>	Silver color	<code>CL_TEAL</code>	Teal color	<code>CL_WHITE</code>	White color	<code>CL_YELLOW</code>	Yellow color
Value	Description																																		
<code>CL_AQUA</code>	Aqua color																																		
<code>CL_BLACK</code>	Black color																																		
<code>CL_BLUE</code>	Blue color																																		
<code>CL_FUCHSIA</code>	Fuchsia color																																		
<code>CL_GRAY</code>	Gray color																																		
<code>CL_GREEN</code>	Green color																																		
<code>CL_LIME</code>	Lime color																																		
<code>CL_MAROON</code>	Maroon color																																		
<code>CL_NAVY</code>	Navy color																																		
<code>CL_OLIVE</code>	Olive color																																		
<code>CL_PURPLE</code>	Purple color																																		
<code>CL_RED</code>	Red color																																		
<code>CL_SILVER</code>	Silver color																																		
<code>CL_TEAL</code>	Teal color																																		
<code>CL_WHITE</code>	White color																																		
<code>CL_YELLOW</code>	Yellow color																																		
Requires	TFT module needs to be initialized. See the TFT_Init routine.																																		
Example	<code>TFT_Fill_Screen(CL_BLACK);</code>																																		

TFT_Dot

Prototype	<code>void TFT_Dot(int x, int y, unsigned int color);</code>																																		
Returns	Nothing.																																		
Description	<p>Draws a dot on the TFT at coordinates (x, y).</p> <p>Parameters :</p> <ul style="list-style-type: none"> - x: dot position on x-axis. - y: dot position on y-axis. - color: color parameter. Valid values : <table border="1" style="margin-left: 20px;"> <thead> <tr> <th>Value</th> <th>Description</th> </tr> </thead> <tbody> <tr> <td><code>CL_AQUA</code></td> <td>Aqua color</td> </tr> <tr> <td><code>CL_BLACK</code></td> <td>Black color</td> </tr> <tr> <td><code>CL_BLUE</code></td> <td>Blue color</td> </tr> <tr> <td><code>CL_FUCHSIA</code></td> <td>Fuchsia color</td> </tr> <tr> <td><code>CL_GRAY</code></td> <td>Gray color</td> </tr> <tr> <td><code>CL_GREEN</code></td> <td>Green color</td> </tr> <tr> <td><code>CL_LIME</code></td> <td>Lime color</td> </tr> <tr> <td><code>CL_MAROON</code></td> <td>Maroon color</td> </tr> <tr> <td><code>CL_NAVY</code></td> <td>Navy color</td> </tr> <tr> <td><code>CL_OLIVE</code></td> <td>Olive color</td> </tr> <tr> <td><code>CL_PURPLE</code></td> <td>Purple color</td> </tr> <tr> <td><code>CL_RED</code></td> <td>Red color</td> </tr> <tr> <td><code>CL_SILVER</code></td> <td>Silver color</td> </tr> <tr> <td><code>CL_TEAL</code></td> <td>Teal color</td> </tr> <tr> <td><code>CL_WHITE</code></td> <td>White color</td> </tr> <tr> <td><code>CL_YELLOW</code></td> <td>Yellow color</td> </tr> </tbody> </table>	Value	Description	<code>CL_AQUA</code>	Aqua color	<code>CL_BLACK</code>	Black color	<code>CL_BLUE</code>	Blue color	<code>CL_FUCHSIA</code>	Fuchsia color	<code>CL_GRAY</code>	Gray color	<code>CL_GREEN</code>	Green color	<code>CL_LIME</code>	Lime color	<code>CL_MAROON</code>	Maroon color	<code>CL_NAVY</code>	Navy color	<code>CL_OLIVE</code>	Olive color	<code>CL_PURPLE</code>	Purple color	<code>CL_RED</code>	Red color	<code>CL_SILVER</code>	Silver color	<code>CL_TEAL</code>	Teal color	<code>CL_WHITE</code>	White color	<code>CL_YELLOW</code>	Yellow color
Value	Description																																		
<code>CL_AQUA</code>	Aqua color																																		
<code>CL_BLACK</code>	Black color																																		
<code>CL_BLUE</code>	Blue color																																		
<code>CL_FUCHSIA</code>	Fuchsia color																																		
<code>CL_GRAY</code>	Gray color																																		
<code>CL_GREEN</code>	Green color																																		
<code>CL_LIME</code>	Lime color																																		
<code>CL_MAROON</code>	Maroon color																																		
<code>CL_NAVY</code>	Navy color																																		
<code>CL_OLIVE</code>	Olive color																																		
<code>CL_PURPLE</code>	Purple color																																		
<code>CL_RED</code>	Red color																																		
<code>CL_SILVER</code>	Silver color																																		
<code>CL_TEAL</code>	Teal color																																		
<code>CL_WHITE</code>	White color																																		
<code>CL_YELLOW</code>	Yellow color																																		
Requires	TFT module needs to be initialized. See the TFT_Init routine.																																		
Example	<code>TFT_Dot(50, 50, CL_BLACK);</code>																																		

TFT_Set_Pen

Prototype	<code>void TFT_Set_Pen(unsigned int pen_color, char pen_width);</code>																																		
Returns	Nothing.																																		
Description	<p>Sets color and thickness parameter for drawing line, circle and rectangle elements.</p> <p>Parameters :</p> <ul style="list-style-type: none"> - <code>pen_color</code>: Sets color. <table border="1"> <thead> <tr> <th>Value</th> <th>Description</th> </tr> </thead> <tbody> <tr> <td><code>CL_AQUA</code></td> <td>Aqua color</td> </tr> <tr> <td><code>CL_BLACK</code></td> <td>Black color</td> </tr> <tr> <td><code>CL_BLUE</code></td> <td>Blue color</td> </tr> <tr> <td><code>CL_FUCHSIA</code></td> <td>Fuchsia color</td> </tr> <tr> <td><code>CL_GRAY</code></td> <td>Gray color</td> </tr> <tr> <td><code>CL_GREEN</code></td> <td>Green color</td> </tr> <tr> <td><code>CL_LIME</code></td> <td>Lime color</td> </tr> <tr> <td><code>CL_MAROON</code></td> <td>Maroon color</td> </tr> <tr> <td><code>CL_NAVY</code></td> <td>Navy color</td> </tr> <tr> <td><code>CL_OLIVE</code></td> <td>Olive color</td> </tr> <tr> <td><code>CL_PURPLE</code></td> <td>Purple color</td> </tr> <tr> <td><code>CL_RED</code></td> <td>Red color</td> </tr> <tr> <td><code>CL_SILVER</code></td> <td>Silver color</td> </tr> <tr> <td><code>CL_TEAL</code></td> <td>Teal color</td> </tr> <tr> <td><code>CL_WHITE</code></td> <td>White color</td> </tr> <tr> <td><code>CL_YELLOW</code></td> <td>Yellow color</td> </tr> </tbody> </table> <ul style="list-style-type: none"> - <code>pen_width</code>: sets thickness. 	Value	Description	<code>CL_AQUA</code>	Aqua color	<code>CL_BLACK</code>	Black color	<code>CL_BLUE</code>	Blue color	<code>CL_FUCHSIA</code>	Fuchsia color	<code>CL_GRAY</code>	Gray color	<code>CL_GREEN</code>	Green color	<code>CL_LIME</code>	Lime color	<code>CL_MAROON</code>	Maroon color	<code>CL_NAVY</code>	Navy color	<code>CL_OLIVE</code>	Olive color	<code>CL_PURPLE</code>	Purple color	<code>CL_RED</code>	Red color	<code>CL_SILVER</code>	Silver color	<code>CL_TEAL</code>	Teal color	<code>CL_WHITE</code>	White color	<code>CL_YELLOW</code>	Yellow color
Value	Description																																		
<code>CL_AQUA</code>	Aqua color																																		
<code>CL_BLACK</code>	Black color																																		
<code>CL_BLUE</code>	Blue color																																		
<code>CL_FUCHSIA</code>	Fuchsia color																																		
<code>CL_GRAY</code>	Gray color																																		
<code>CL_GREEN</code>	Green color																																		
<code>CL_LIME</code>	Lime color																																		
<code>CL_MAROON</code>	Maroon color																																		
<code>CL_NAVY</code>	Navy color																																		
<code>CL_OLIVE</code>	Olive color																																		
<code>CL_PURPLE</code>	Purple color																																		
<code>CL_RED</code>	Red color																																		
<code>CL_SILVER</code>	Silver color																																		
<code>CL_TEAL</code>	Teal color																																		
<code>CL_WHITE</code>	White color																																		
<code>CL_YELLOW</code>	Yellow color																																		
Requires	TFT module needs to be initialized. See the <code>TFT_Init</code> routine.																																		
Example	<code>TFT_Set_Pen(CL_BLACK, 10);</code>																																		

TFT_Set_Brush

Prototype	<code>void TFT_Set_Brush(char brush_enabled, unsigned int brush_color, char gradient_enabled, char gradient_orientation, unsigned int gradient_color_from, unsigned int gradient_color_to);</code>																																								
Returns	Nothing.																																								
Description	<p>Sets color and gradient which will be used to fill circles or rectangles.</p> <p>Parameters :</p> <ul style="list-style-type: none"> - <code>brush_enabled</code>: enable brush fill. <table border="1"> <thead> <tr> <th>Value</th> <th>Description</th> </tr> </thead> <tbody> <tr> <td>1</td> <td>Enable brush fill.</td> </tr> <tr> <td>0</td> <td>Disable brush fill.</td> </tr> </tbody> </table> <ul style="list-style-type: none"> - <code>brush_color</code>: set brush fill color. <table border="1"> <thead> <tr> <th>Value</th> <th>Description</th> </tr> </thead> <tbody> <tr> <td><code>CL_AQUA</code></td> <td>Aqua color</td> </tr> <tr> <td><code>CL_BLACK</code></td> <td>Black color</td> </tr> <tr> <td><code>CL_BLUE</code></td> <td>Blue color</td> </tr> <tr> <td><code>CL_FUCHSIA</code></td> <td>Fuchsia color</td> </tr> <tr> <td><code>CL_GRAY</code></td> <td>Gray color</td> </tr> <tr> <td><code>CL_GREEN</code></td> <td>Green color</td> </tr> <tr> <td><code>CL_LIME</code></td> <td>Lime color</td> </tr> <tr> <td><code>CL_MAROON</code></td> <td>Maroon color</td> </tr> <tr> <td><code>CL_NAVY</code></td> <td>Navy color</td> </tr> <tr> <td><code>CL_OLIVE</code></td> <td>Olive color</td> </tr> <tr> <td><code>CL_PURPLE</code></td> <td>Purple color</td> </tr> <tr> <td><code>CL_RED</code></td> <td>Red color</td> </tr> <tr> <td><code>CL_SILVER</code></td> <td>Silver color</td> </tr> <tr> <td><code>CL_TEAL</code></td> <td>Teal color</td> </tr> <tr> <td><code>CL_WHITE</code></td> <td>White color</td> </tr> <tr> <td><code>CL_YELLOW</code></td> <td>Yellow color</td> </tr> </tbody> </table>	Value	Description	1	Enable brush fill.	0	Disable brush fill.	Value	Description	<code>CL_AQUA</code>	Aqua color	<code>CL_BLACK</code>	Black color	<code>CL_BLUE</code>	Blue color	<code>CL_FUCHSIA</code>	Fuchsia color	<code>CL_GRAY</code>	Gray color	<code>CL_GREEN</code>	Green color	<code>CL_LIME</code>	Lime color	<code>CL_MAROON</code>	Maroon color	<code>CL_NAVY</code>	Navy color	<code>CL_OLIVE</code>	Olive color	<code>CL_PURPLE</code>	Purple color	<code>CL_RED</code>	Red color	<code>CL_SILVER</code>	Silver color	<code>CL_TEAL</code>	Teal color	<code>CL_WHITE</code>	White color	<code>CL_YELLOW</code>	Yellow color
Value	Description																																								
1	Enable brush fill.																																								
0	Disable brush fill.																																								
Value	Description																																								
<code>CL_AQUA</code>	Aqua color																																								
<code>CL_BLACK</code>	Black color																																								
<code>CL_BLUE</code>	Blue color																																								
<code>CL_FUCHSIA</code>	Fuchsia color																																								
<code>CL_GRAY</code>	Gray color																																								
<code>CL_GREEN</code>	Green color																																								
<code>CL_LIME</code>	Lime color																																								
<code>CL_MAROON</code>	Maroon color																																								
<code>CL_NAVY</code>	Navy color																																								
<code>CL_OLIVE</code>	Olive color																																								
<code>CL_PURPLE</code>	Purple color																																								
<code>CL_RED</code>	Red color																																								
<code>CL_SILVER</code>	Silver color																																								
<code>CL_TEAL</code>	Teal color																																								
<code>CL_WHITE</code>	White color																																								
<code>CL_YELLOW</code>	Yellow color																																								

Description

- `gradient_enabled`: enable gradient

Value	Description
1	Enable gradient.
0	Disable gradient.

- `gradient_orientation`: sets gradient orientation :

Value	Description
<code>LEFT_TO_RIGHT</code>	Left to right gradient orientation
<code>TOP_TO_BOTTOM</code>	Top to bottom gradient orientation

- `gradient_color_from`: sets the starting gradient color.

Value	Description
<code>CL_AQUA</code>	Aqua color
<code>CL_BLACK</code>	Black color
<code>CL_BLUE</code>	Blue color
<code>CL_FUCHSIA</code>	Fuchsia color
<code>CL_GRAY</code>	Gray color
<code>CL_GREEN</code>	Green color
<code>CL_LIME</code>	Lime color
<code>CL_MAROON</code>	Maroon color
<code>CL_NAVY</code>	Navy color
<code>CL_OLIVE</code>	Olive color
<code>CL_PURPLE</code>	Purple color
<code>CL_RED</code>	Red color
<code>CL_SILVER</code>	Silver color
<code>CL_TEAL</code>	Teal color
<code>CL_WHITE</code>	White color
<code>CL_YELLOW</code>	Yellow color

Description	- <code>gradient_color_to</code> : sets the ending gradient color.	
	Value	Description
	<code>CL_AQUA</code>	Aqua color
	<code>CL_BLACK</code>	Black color
	<code>CL_BLUE</code>	Blue color
	<code>CL_FUCHSIA</code>	Fuchsia color
	<code>CL_GRAY</code>	Gray color
	<code>CL_GREEN</code>	Green color
	<code>CL_LIME</code>	Lime color
	<code>CL_MAROON</code>	Maroon color
	<code>CL_NAVY</code>	Navy color
	<code>CL_OLIVE</code>	Olive color
	<code>CL_PURPLE</code>	Purple color
	<code>CL_RED</code>	Red color
	<code>CL_SILVER</code>	Silver color
<code>CL_TEAL</code>	Teal color	
<code>CL_WHITE</code>	White color	
<code>CL_YELLOW</code>	Yellow color	
Requires	TFT module needs to be initialized. See the <code>TFT_Init</code> routine.	
Example	<pre>// Enable gradient from black to white color, left-right orientation TFT_Set_Brush(0, 0, 1, LEFT_TO_RIGHT, CL_BLACK, CL_WHITE);</pre>	

TFT_Line

Prototype	<code>void TFT_Line(int x1, int y1, int x2, int y2);</code>
Returns	Nothing.
Description	<p>Draws a line from (x1, y1) to (x2, y2).</p> <p>Parameters :</p> <ul style="list-style-type: none"> - <code>x1</code>: x coordinate of the line start. - <code>y1</code>: y coordinate of the line end. - <code>x2</code>: x coordinate of the line start. - <code>y2</code>: y coordinate of the line end.
Requires	TFT module needs to be initialized. See the <code>TFT_Init</code> routine.
Example	<code>TFT_Line(0, 0, 239, 127);</code>

TFT_H_Line

Prototype	<code>void TFT_H_Line(int x_start, int x_end, int y_pos);</code>
Returns	Nothing.
Description	<p>Draws a horizontal line on TFT.</p> <p>Parameters :</p> <ul style="list-style-type: none"> - <code>x_start</code>: x coordinate of the line start. - <code>x_end</code>: x coordinate of the line end. - <code>y_pos</code>: y coordinate of horizontal line.
Requires	TFT module needs to be initialized. See the TFT_Init routine.
Example	<pre>// Draw a horizontal line between dots (10,20) and (50,20) TFT_H_Line(10, 50, 20);</pre>

TFT_V_Line

Prototype	<code>void TFT_V_Line(int y_start, int y_end, int x_pos);</code>
Returns	Nothing.
Description	<p>Draws a vertical line on TFT.</p> <p>Parameters :</p> <ul style="list-style-type: none"> - <code>y_start</code>: y coordinate of the line start. - <code>y_end</code>: y coordinate of the line end. - <code>x_pos</code>: x coordinate of vertical line.
Requires	TFT module needs to be initialized. See the TFT_Init routine.
Example	<pre>// Draw a vertical line between dots (10,5) and (10,25) TFT_V_Line(5, 25, 10);</pre>

TFT_Rectangle_Round_Edges

Prototype	<code>void TFT_Rectangle_Round_Edges(unsigned int x_upper_left, unsigned int y_upper_left, unsigned int x_bottom_right, unsigned int y_bottom_right, unsigned int round_radius);</code>
Returns	Nothing.
Description	<p>Draws a rounded edge rectangle on TFT.</p> <p>Parameters :</p> <ul style="list-style-type: none"> - <code>x_upper_left</code>: x coordinate of the upper left rectangle corner. - <code>y_upper_left</code>: y coordinate of the upper left rectangle corner. - <code>x_bottom_right</code>: x coordinate of the lower right rectangle corner. - <code>y_bottom_right</code>: y coordinate of the lower right rectangle corner. - <code>round_radius</code>: radius of the rounded edge.
Requires	TFT module needs to be initialized. See the TFT_Init routine.
Example	<code>TFT_Rectangle_Round_Edges(20, 20, 219, 107, 12);</code>

TFT_Circle

Prototype	<code>void TFT_Circle(int x_center, int y_center, int radius);</code>
Returns	Nothing.
Description	<p>Draws a circle on TFT.</p> <p>Parameters :</p> <ul style="list-style-type: none"> - <code>x</code>: x coordinate of the circle center. - <code>y</code>: y coordinate of the circle center. - <code>r</code>: radius size.
Requires	TFT module needs to be initialized. See the TFT_Init routine.
Example	<code>TFT_Circle(120, 64, 110);</code>

TFT_Image

Prototype	<code>void TFT_Image(unsigned int left, unsigned int top, code const far unsigned short * image, unsigned short stretch);</code>
Returns	Nothing.
Description	<p>Displays an image on a desired location.</p> <p>Parameters :</p> <ul style="list-style-type: none"> - <code>left</code>: position of the image's left edge. - <code>top</code>: position of the image's top edge. - <code>image</code>: image to be displayed. Bitmap array is located in code memory. - <code>stretch</code>: stretches image by a given factor (if 2, it will double the image.).
Requires	TFT module needs to be initialized. See the TFT_Init routine.
Example	<code>TFT_Image(0, 0, image, 1);</code>

TFT_Partial_Image

Prototype	<code>void TFT_Partial_Image(unsigned int left, unsigned int top, unsigned int width, unsigned int height, code const far unsigned short * image, unsigned short stretch);</code>
Returns	Nothing.
Description	<p>Displays a partial area of the image on a desired location.</p> <p>Parameters :</p> <ul style="list-style-type: none"> - <code>left</code>: left coordinate of the image. - <code>top</code>: top coordinate of the image. - <code>width</code>: desired image width. - <code>height</code>: desired image height. - <code>image</code>: image to be displayed. Bitmap array is located in code memory. - <code>stretch</code>: stretches image by a given factor (if 2, it will double the image.).
Requires	TFT module needs to be initialized. See the TFT_Init routine.
Example	<pre>// Draws a 10x15 part of the image starting from the upper left corner on the coordinate (10,12) TFT_PartialImage(10, 12, 10, 15, image, 1);</pre>

TFT_Image_Jpeg

Prototype	<code>char TFT_Image_Jpeg(unsigned int left, unsigned int top, code const far unsigned short *image);</code>
Returns	<ul style="list-style-type: none"> - 0 - if image is loaded and displayed successfully. - 1 - if error occurred.
Description	<p>Displays a JPEG image on a desired location.</p> <p>Parameters :</p> <ul style="list-style-type: none"> - <code>left</code>: left coordinate of the image. - <code>top</code>: top coordinate of the image. - <code>image</code>: image to be displayed. Bitmap array is located in code memory.
Requires	TFT module needs to be initialized. See the TFT_Init routine.
Example	<code>TFT_Image_Jpeg(0, 0, image);</code>

TFT_RGBToColor16bit

Prototype	<code>unsigned int TFT_RGBToColor16bit(char rgb_red, char rgb_green, char rgb_blue);</code>
Returns	Returns a color value in the following bit-order : 5 bits red, 6 bits green and 5 bits blue color.
Description	Converts 5:6:5 RGB format into true color format. Parameters : - <code>rgb_red</code> : red component of the image. - <code>rgb_green</code> : green component of the image. - <code>rgb_blue</code> : blue component of the image.
Requires	TFT module needs to be initialized. See the TFT_Init routine.
Example	<code>color16 = TFT_Image_Jpeg(150, 193, 65);</code>

TFT_Color16bitToRGB

Prototype	<code>void TFT_Color16bitToRGB(unsigned int color, char *rgb_red, char *rgb_green, char *rgb_blue);</code>
Returns	Nothing.
Description	Converts true color into 5:6:5 RGB format. Parameters : - <code>color</code> : true color to be converted. - <code>rgb_red</code> : red component of the input color. - <code>rgb_green</code> : green component of the input color. - <code>rgb_blue</code> : blue component of the input color.
Requires	TFT module needs to be initialized. See the TFT_Init routine.
Example	<code>TFT_Color16bitToRGB(start_color, &red_start, &green_start, &blue_start);</code>

Touch Panel Library

The mikroC PRO for dsPIC30/33 and PIC24 provides a library for working with Touch Panel.

Library Dependency Tree



External dependencies of Touch Panel Library

The following variables must be defined in all projects using Touch Panel Library:	Description:	Example:
<code>extern sfr sbit DriveA;</code>	DriveA line.	<code>sbit DriveA at LATC13_bit;</code>
<code>extern sfr sbit DriveB;</code>	DriveB line.	<code>sbit DriveB at LATC14_bit;</code>
<code>extern sfr sbit DriveA_Direction;</code>	Direction of the DriveA pin.	<code>sbit DriveA_Direction at TRISC13_bit;</code>
<code>extern sfr sbit DriveB_Direction;</code>	Direction of the DriveB pin.	<code>sbit DriveB_Direction at TRISC14_bit;</code>

Library Routines

- TP_Init
- TP_Set_ADC_Threshold
- TP_Press_Detect
- TP_Get_Coordinates
- TP_Calibrate_Bottom_Left
- TP_Calibrate_Upper_Right
- TP_Get_Calibration_Consts
- TP_Set_Calibration_Consts

TP_Init

Prototype	<code>void TP_Init(unsigned int display_width, unsigned int display_height, unsigned int readX_ChNo, unsigned int readY_ChNo);</code>
Description	Initialize touch panel display. Default touch panel ADC threshold value is set to 3900.
Parameters	<ul style="list-style-type: none"> - <code>display_width</code>: set display width. - <code>display_height</code>: set display height. - <code>readX_ChNo</code>: read X coordinate from desired ADC channel. - <code>readY_ChNo</code>: read Y coordinate from desired ADC channel.
Returns	Nothing.
Requires	Before calling this function initialize ADC module.
Example	<pre>ADC1_Init(); // Initialize ADC module TP_Init(128, 64, 6, 7); // Initialize touch panel, dimensions 128x64</pre>
Notes	None.

TP_Set_ADC_Threshold

Prototype	<code>void TP_Set_ADC_Threshold(unsigned int threshold);</code>
Description	Set custom ADC threshold value, call this function after TP_Init.
Parameters	<ul style="list-style-type: none"> - <code>threshold</code>: custom ADC threshold value.
Returns	Nothing.
Requires	TP_Init has to be called before using this routine.
Example	<pre>TP_Set_ADC_Threshold(3900); // Set touch panel ADC threshold</pre>
Notes	None.

TP_Press_Detect

Prototype	<code>char TP_Press_Detect();</code>
Description	Detects if the touch panel has been pressed.
Parameters	None.
Returns	- 1 - if touch panel is pressed. - 0 - otherwise.
Requires	Global variables: - <code>DriveA</code> : DriveA. - <code>DriveB</code> : DriveB. - <code>DriveA_Direction</code> : Direction of DriveA pin. - <code>DriveB_Direction</code> : Direction of DriveB pin. must be defined before using this function.
Example	<pre>// Touch Panel module connections sbit DriveA at LATC13_bit; sbit DriveB at LATC14_bit; sbit DriveA_Direction at TRISC13_bit; sbit DriveB_Direction at TRISC14_bit; // End Touch Panel module connections if (TP_Press_Detect()) { ... }</pre>
Notes	None.

TP_Get_Coordinates

Prototype	<code>char TP_Get_Coordinates(unsigned int *x_coordinate, unsigned int *y_coordinate);</code>
Description	Get touch panel coordinates and store them in <code>x_coordinate</code> and <code>y_coordinate</code> parameters.
Parameters	<ul style="list-style-type: none"> - <code>x_coordinate</code>: x coordinate of the place of touch. - <code>y_coordinate</code>: y coordinate of the place of touch.
Returns	<ul style="list-style-type: none"> - 1 - if reading is within display dimension range. - 0 - if reading is out of display dimension range.
Requires	Nothing.
Example	<pre>if (TP_Get_Coordinates(&x_coord, &y_coord) == 0) { ... }</pre>
Notes	None.

TP_Calibrate_Bottom_Left

Prototype	<code>void TP_Calibrate_Bottom_Left();</code>
Description	Calibrate bottom left corner of the touch Panel.
Parameters	None.
Returns	Nothing.
Requires	Nothing.
Example	<code>TP_Calibrate_Bottom_Left(); // Calibration of bottom left corner</code>
Notes	None.

TP_Calibrate_Upper_Right

Prototype	<code>void TP_Calibrate_Upper_Right();</code>
Description	Calibrate upper right corner of the touch panel.
Parameters	None.
Returns	Nothing.
Requires	Nothing.
Example	<code>TP_Calibrate_Upper_Right(); // Calibration of upper right corner</code>
Notes	None.

TP_Get_Calibration_Consts

Prototype	<code>void TP_Get_Calibration_Consts(unsigned int *x_min, unsigned int *x_max, unsigned int *y_min, unsigned int *y_max);</code>
Description	Gets calibration constants after calibration is done and stores them in <code>x_min</code> , <code>x_max</code> , <code>y_min</code> and <code>y_max</code> parameters.
Parameters	<ul style="list-style-type: none"> - <code>x_min</code>: x coordinate of the bottom left corner of the working area. - <code>x_max</code>: x coordinate of the upper right corner of the working area. - <code>y_min</code>: y coordinate of the bottom left corner of the working area. - <code>y_max</code>: y coordinate of the upper right corner of the working area.
Returns	Nothing.
Requires	Nothing.
Example	<code>TP_Get_Calibration_Consts(&x_min, &y_min, &x_max, &y_max); // Get calibration constants</code>
Notes	None.

TP_Set_Calibration_Consts

Prototype	<code>void TP_Set_Calibration_Consts(unsigned int x_min, unsigned int x_max, unsigned int y_min, unsigned int y_max);</code>
Description	Sets calibration constants.
Parameters	<ul style="list-style-type: none"> - <code>x_min</code>: x coordinate of the bottom left corner of the working area. - <code>x_max</code>: x coordinate of the upper right corner of the working area. - <code>y_min</code>: y coordinate of the bottom left corner of the working area. - <code>y_max</code>: y coordinate of the upper right corner of the working area.
Returns	Nothing.
Requires	Nothing.
Example	<code>TP_Set_Calibration_Consts(148, 3590, 519, 3370); // Set calibration constants</code>
Notes	None.

Library Example

The following drawing demo tests routines of the Touch Panel library:

Copy Code To Clipboard

```
// Glcd module connections
sbit GLCD_D7 at RD3_bit;
sbit GLCD_D6 at RD2_bit;
sbit GLCD_D5 at RD1_bit;
sbit GLCD_D4 at RD0_bit;
sbit GLCD_D3 at RB3_bit;
sbit GLCD_D2 at RB2_bit;
sbit GLCD_D1 at RB1_bit;
sbit GLCD_D0 at RB0_bit;
sbit GLCD_D7_Direction at TRISD3_bit;
sbit GLCD_D6_Direction at TRISD2_bit;
sbit GLCD_D5_Direction at TRISD1_bit;
sbit GLCD_D4_Direction at TRISD0_bit;
sbit GLCD_D3_Direction at TRISB3_bit;
sbit GLCD_D2_Direction at TRISB2_bit;
sbit GLCD_D1_Direction at TRISB1_bit;
sbit GLCD_D0_Direction at TRISB0_bit;
```

```
sbit GLCD_CS1 at LATB4_bit;
sbit GLCD_CS2 at LATB5_bit;
sbit GLCD_RS  at LATF0_bit;
sbit GLCD_RW  at LATF1_bit;
sbit GLCD_EN  at LATF4_bit;
sbit GLCD_RST at LATF5_bit;
sbit GLCD_CS1_Direction at TRISB4_bit;
sbit GLCD_CS2_Direction at TRISB5_bit;
sbit GLCD_RS_Direction  at TRISF0_bit;
sbit GLCD_RW_Direction  at TRISF1_bit;
sbit GLCD_EN_Direction  at TRISF4_bit;
sbit GLCD_RST_Direction at TRISF5_bit;
// End Glcd module connections

// Touch Panel module connections
sbit DriveA at LATC13_bit;
sbit DriveB at LATC14_bit;
sbit DriveA_Direction at TRISC13_bit;
sbit DriveB_Direction at TRISC14_bit;
// End Touch Panel module connections

bit          write_erase;
char         pen_size;
char write_msg[] = "WRITE";           // GLCD menu messages
char clear_msg[] = "CLEAR";
char erase_msg[] = "ERASE";
unsigned int x_coord, y_coord;

void Initialize() {
    ADPCFG = 0xFF3F;                 // set AN6 and AN7 channel pins as analog

    DriveA_Direction = 0;            // Set DriveA pin as output
    DriveB_Direction = 0;            // Set DriveB pin as output

    Glcd_Init();                     // Initialize GLCD
    Glcd_Fill(0);                    // Clear GLCD

    ADC1_Init();                     // Initalize ADC module
    TP_Init(128, 64, 6, 7);          // Initialize touch panel
    TP_Set_ADC_Threshold(3900);      // Set touch panel ADC threshold
}

void Calibrate() {

    Glcd_Dot(0,63,1);                // Draw bottom left dot
    Glcd_Write_Text("TOUCH BOTTOM LEFT",12,3,1);
    TP_Calibrate_Bottom_Left();      // Calibration of bottom left corner
    Delay_ms(1000);
}
```

```

    Glcd_Dot(0,63,0);           // Clear bottom left dot
    Glcd_Dot(127,0,1);        // Draw upper right dot
    Glcd_Write_Text("        ",12,3,1);
    Glcd_Write_Text("TOUCH UPPER RIGHT",12,4,1);
    TP_Calibrate_Upper_Right(); // Calibration of upper right corner

    Delay_ms(1000);
}

void main() {

Initialize();

    Glcd_Write_Text("CALIBRATION",12,3,1);
    Delay_ms(1000);
    Glcd_Fill(0);           // Clear GLCD
    Calibrate();

    Glcd_Fill(0);
    Glcd_Write_Text("WRITE ON SCREEN", 20, 5, 1) ;
    Delay_ms(1000);

    Glcd_Fill(0);           // Clear GLCD
    Glcd_V_Line(0,7,0,1);
    Glcd_Write_Text(clear_msg,1,0,0);
    Glcd_V_Line(0,7,97,1);
    Glcd_Write_Text(erase_msg,98,0,0);

    // Pen Menu:
    Glcd_Rectangle(41,0,52,9,1);
    Glcd_Box(45,3,48,6,1);
    Glcd_Rectangle(63,0,70,7,1);
    Glcd_Box(66,3,67,4,1);
    Glcd_Rectangle(80,0,86,6,1);
    Glcd_Dot(83,3,1);

    write_erase = 1;
    pen_size = 1;
    while (1) {

if (TP_Press_Detect()) {
    // After a PRESS is detected read X-Y and convert it to 128x64 space
    if (TP_Get_Coordinates(&x_coord, &y_coord) == 0) {

        if ((x_coord < 31) && (y_coord < 8)) {

            Glcd_Fill(0);

```



```
// Pen Menu:
    Glcd_Rectangle(41,0,52,9,1);
    Glcd_Box(45,3,48,6,1);
    Glcd_Rectangle(63,0,70,7,1);
    Glcd_Box(66,3,67,4,1);
    Glcd_Rectangle(80,0,86,6,1);
    Glcd_Dot(83,3,1);

    Glcd_V_Line(0,7,0,1);
    Glcd_Write_Text(clear_msg,1,0,0);
    Glcd_V_Line(0,7,97,1);
    if (write_erase)
        Glcd_Write_Text(erase_msg,98,0,0);
    else
        Glcd_Write_Text(write_msg,98,0,0);
}

// If write/erase is pressed
if ((x_coord > 96) && (y_coord < 8)) {
    if (write_erase) {
        write_erase = 0;
        Glcd_Write_Text(write_msg,98,0,0);
        Delay_ms(500);
    }
    else {
        write_erase = 1;
        Glcd_Write_Text(erase_msg,98,0,0);
        Delay_ms(500);
    }
}

// If pen size is selected
if ((x_coord >= 41) && (x_coord <= 52) && (y_coord <= 9))
    pen_size = 3;

if ((x_coord >= 63) && (x_coord <= 70) && (y_coord <= 7))
    pen_size = 2;

if ((x_coord >= 80) && (x_coord <= 86) && (y_coord <= 6))
    pen_size = 1;

if (y_coord < 11)
    continue;

switch (pen_size) {
    case 1 : {
        if ( (x_coord >= 0) && (y_coord >= 0) && (x_coord <= 127) && (y_coord <= 63) )
            Glcd_Dot(x_coord, y_coord, write_erase);
        break;
    }
}
```

```
case 2 : {
    if ( (x_coord >= 0) && (y_coord >= 0) && (x_coord <= 127-1) && (y_coord <= 63-1) )
        Glcd_Box(x_coord, y_coord, x_coord + 1, y_coord + 1, write_erase);
        break;
    }
case 3 : {
    if ( (x_coord >= 1) && (y_coord >= 1) && (x_coord <= 127-2) && (y_coord <= 63-2) )
        Glcd_Box(x_coord-1, y_coord-1, x_coord + 2, y_coord + 2, write_erase);
        break;
    }
}
}
}
}
```

Touch Panel TFT Library

The mikroC PRO for dsPIC30/33 and PIC24 provides a library for working with Touch Panel for TFT.

Library Dependency Tree



External dependencies of Touch Panel TFT Library

The following variables must be defined in all projects using Touch Panel TFT Library:	Description:	Example:
<code>extern sfr sbit DriveX_Left;</code>	DriveX_Left line.	<code>sbit DriveX_Left at LATB13_bit;</code>
<code>extern sfr sbit DriveX_Right;</code>	DriveX_Right line.	<code>sbit DriveX_Right at LATB11_bit;</code>
<code>extern sfr sbit DriveY_Up;</code>	DriveY_Up line.	<code>sbit DriveY_Up at LATB12_bit;</code>
<code>extern sfr sbit DriveY_Down;</code>	DriveY_Down line.	<code>sbit DriveY_Down at LATB10_bit;</code>
<code>extern sfr sbit DriveX_Left_Direction;</code>	Direction of the DriveX_Left pin.	<code>sbit DriveX_Left_Direction at TRISB13_bit;</code>
<code>extern sfr sbit DriveX_Right_Direction;</code>	Direction of the DriveX_Right pin.	<code>sbit DriveX_Right_Direction at TRISB11_bit;</code>
<code>extern sfr sbit DriveY_Up_Direction;</code>	Direction of the DriveY_Up pin.	<code>sbit DriveY_Up_Direction at TRISB12_bit;</code>
<code>extern sfr sbit DriveY_Down_Direction;</code>	Direction of the DriveY_Down pin.	<code>sbit DriveY_Down_Direction at TRISB10_bit;</code>

Library Routines

- TP_TFT_Init
- TP_TFT_Set_ADC_Threshold
- TP_TFT_Press_Detect
- TP_TFT_Get_Coordinates
- TP_TFT_Calibrate_Min
- TP_TFT_Calibrate_Max
- TP_TFT_Get_Calibration_Consts
- TP_TFT_Set_Calibration_Consts

TP_TFT_Init

Prototype	<code>void TP_TFT_Init(unsigned int display_width, unsigned int display_height, unsigned int readX_ChNo, unsigned int readY_ChNo);</code>
Description	Initialize TFT touch panel display. Default touch panel ADC threshold value is set to 900.
Parameters	<ul style="list-style-type: none"> - <code>display_width</code>: set display width. - <code>display_height</code>: set display height. - <code>readX_ChNo</code>: read X coordinate from desired ADC channel. - <code>readY_ChNo</code>: read Y coordinate from desired ADC channel.
Returns	Nothing.
Requires	Before calling this function initialize ADC module.
Example	<pre>ADC1_Init(); // Initalize ADC module TP_TFT_Init(320, 240, 13, 12); // Initialize touch panel</pre>
Notes	None.

TP_TFT_Set_ADC_Threshold

Prototype	<code>void TP_TFT_Set_ADC_Threshold(unsigned int threshold);</code>
Description	Set custom ADC threshold value, call this function after TP_TFT_Init.
Parameters	<ul style="list-style-type: none"> - <code>threshold</code>: custom ADC threshold value.
Returns	Nothing.
Requires	TP_TFT_Init has to be called before using this routine.
Example	<pre>TP_TFT_Set_ADC_Threshold(900); // Set touch panel ADC threshold</pre>
Notes	None.

TP_TFT_Press_Detect

Prototype	<code>char TP_TFT_Press_Detect();</code>
Description	Detects if the touch panel has been pressed.
Parameters	None.
Returns	- 1 - if touch panel is pressed. - 0 - otherwise.
Requires	Global variables: <ul style="list-style-type: none"> - <code>DriveX_Left</code>: DriveX_Left pin. - <code>DriveX_Right</code>: DriveX_Right pin. - <code>DriveY_Up</code>: DriveY_Up pin. - <code>DriveY_Down</code>: DriveY_Down pin. - <code>DriveX_Left_Direction</code>: Direction of DriveX_Left pin. - <code>DriveX_Right_Direction</code>: Direction of DriveX_Right pin. - <code>DriveY_Up_Direction</code>: Direction of DriveY_Up pin. - <code>DriveY_Down_Direction</code>: Direction of DriveY_Down pin. <p>must be defined before using this function.</p>
Example	<pre>// Touch Panel module connections sbit DriveX_Left at LATB13_bit; sbit DriveX_Right at LATB11_bit; sbit DriveY_Up at LATB12_bit; sbit DriveY_Down at LATB10_bit; sbit DriveX_Left_Direction at TRISB13_bit; sbit DriveX_Right_Direction at TRISB11_bit; sbit DriveY_Up_Direction at TRISB12_bit; sbit DriveY_Down_Direction at TRISB10_bit; // End Touch Panel module connections if (TP_TFT_Press_Detect()) { ... }</pre>
Notes	None.

TP_TFT_Get_Coordinates

Prototype	<code>char TP_TFT_Get_Coordinates(unsigned int *x_coordinate, unsigned int *y_coordinate);</code>
Description	Get touch panel coordinates and store them in <code>x_coordinate</code> and <code>y_coordinate</code> parameters.
Parameters	<ul style="list-style-type: none"> - <code>x_coordinate</code>: x coordinate of the place of touch. - <code>y_coordinate</code>: y coordinate of the place of touch.
Returns	<ul style="list-style-type: none"> - 1 - if reading is within display dimension range. - 0 - if reading is out of display dimension range.
Requires	Nothing.
Example	<pre>if (TP_TFT_Get_Coordinates(&x_coord, &y_coord) == 0) { ... }</pre>
Notes	None.

TP_TFT_Calibrate_Min

Prototype	<code>void TP_TFT_Calibrate_Min();</code>
Description	Calibrate bottom left corner of the touch Panel.
Parameters	None.
Returns	Nothing.
Requires	Nothing.
Example	<code>TP_TFT_Calibrate_Min(); // Calibration of bottom left corner</code>
Notes	None.

TP_TFT_Calibrate_Max

Prototype	<code>void TP_TFT_Calibrate_Max();</code>
Description	Calibrate upper right corner of the touch panel.
Parameters	None.
Returns	Nothing.
Requires	Nothing.
Example	<code>TP_TFT_Calibrate_Max(); // Calibration of upper right corner</code>
Notes	None.

TP_TFT_Get_Calibration_Consts

Prototype	<code>void TP_TFT_Get_Calibration_Consts(unsigned int *x_min, unsigned int *x_max, unsigned int *y_min, unsigned int *y_max);</code>
Description	Gets calibration constants after calibration is done and stores them in <code>x_min</code> , <code>x_max</code> , <code>y_min</code> and <code>y_max</code> parameters.
Parameters	<ul style="list-style-type: none"> - <code>x_min</code>: x coordinate of the bottom left corner of the working area. - <code>x_max</code>: x coordinate of the upper right corner of the working area. - <code>y_min</code>: y coordinate of the bottom left corner of the working area. - <code>y_max</code>: y coordinate of the upper right corner of the working area.
Returns	Nothing.
Requires	Nothing.
Example	<code>TP_TFT_Get_Calibration_Consts(&x_min, &y_min, &x_max, &y_max);</code>
Notes	None.

TP_TFT_Set_Calibration_Consts

Prototype	<code>void TP_TFT_Set_Calibration_Consts(unsigned int x_min, unsigned int x_max, unsigned int y_min, unsigned int y_max);</code>
Description	Sets calibration constants.
Parameters	<ul style="list-style-type: none"> - <code>x_min</code>: x coordinate of the bottom left corner of the working area. - <code>x_max</code>: x coordinate of the upper right corner of the working area. - <code>y_min</code>: y coordinate of the bottom left corner of the working area. - <code>y_max</code>: y coordinate of the upper right corner of the working area.
Returns	Nothing.
Requires	Nothing.
Example	<code>TP_TFT_Set_Calibration_Consts(173, 776, 75, 760); // Set calibration constants</code>
Notes	None.

HW Connection

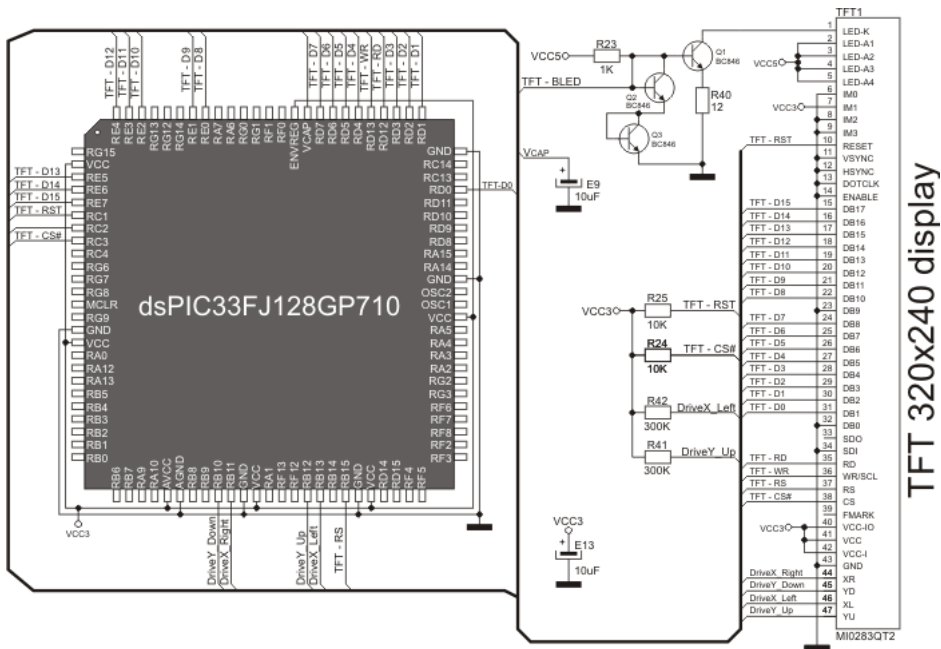

UART Library

The UART hardware module is available with a number of dsPIC30/33 and PIC24 MCUs. The mikroC PRO for dsPIC30/33 and PIC24 UART Library provides comfortable work with the Asynchronous (full duplex) mode.

Important:

- UART library routines require you to specify the module you want to use. To select the desired UART module, simply change the letter **x** in the routine prototype for a number from **1** to **4**.
- Switching between the UART modules in the UART library is done by the `UART_Set_Active` function (UART modules have to be previously initialized).
- Number of UART modules per MCU differs from chip to chip. Please, read the appropriate datasheet before utilizing this library.

Library Routines

- `UARTx_Init`
- `UARTx_Init_Advanced`
- `UARTx_Data_Ready`
- `UARTx_Tx_Idle`
- `UARTx_Read`
- `UARTx_Read_Text`
- `UARTx_Write`
- `UARTx_Write_Text`
- `UART_Set_Active`

UARTx_Init

Prototype	<code>void UARTx_Init(unsigned long baud_rate);</code>
Description	<p>Configures and initializes the UART module.</p> <p>The internal UART module module is set to:</p> <ul style="list-style-type: none"> - continue operation in IDLE mode - default Tx and Rx pins - loopback mode disabled - 8-bit data, no parity - 1 STOP bit - transmitter enabled - generate interrupt on transmission end - interrupt on reception enabled - Address Detect mode disabled
Parameters	- <code>baud_rate</code> : requested baud rate
Returns	Nothing.
Requires	Routine requires the UART module.
Example	<pre>// Initialize hardware UART1 module and establish communication at 2400 bps UART1_Init(2400);</pre>
Notes	<p>Refer to the device data sheet for baud rates allowed for specific Fosc.</p> <p>For the dsPIC33 and PIC24 MCUs, the compiler will choose for which speed the calculation is to be performed (high or low). This does not mean that it is the best choice for desired baud rate. If the baud rate error generated in this way is too big then UARTx_Init_Advanced routine, which allows speed select be used.</p> <p>UART library routines require you to specify the module you want to use. To select the desired UART module, simply change the letter x in the routine prototype for a number from 1 to 4.</p> <p>Switching between the UART modules in the UART library is done by the UART_Set_Active function (UART modules have to be previously initialized).</p> <p>Number of UART modules per MCU differs from chip to chip. Please, read the appropriate datasheet before utilizing this library.</p>

UARTx_Init_Advanced

Prototype	<pre>// dsPIC30 prototype void UARTx_Init_Advanced(unsigned long baud_rate, unsigned int parity, unsigned int stop_bits); // dsPIC33 and PIC24 prototype void UARTx_Init_Advanced(unsigned long baud_rate, unsigned int parity, unsigned int stop_bits, unsigned int high_low_speed);</pre>																												
Description	Configures and initializes the UART module with user defined settings.																												
Parameters	<p>- <code>baud_rate</code>: requested baud rate - <code>parity</code>: parity and data selection parameter.</p> <p>Valid values:</p> <table border="1" data-bbox="396 611 1110 836"> <thead> <tr> <th colspan="2">Data/Parity Mode</th> </tr> <tr> <th>Description</th> <th>Predefined library const</th> </tr> </thead> <tbody> <tr> <td>8-bit data, no parity</td> <td><code>_UART_8BIT_NOPARITY</code></td> </tr> <tr> <td>8-bit data, even parity</td> <td><code>_UART_8BIT_EVENPARITY</code></td> </tr> <tr> <td>8-bit data, odd parity</td> <td><code>_UART_8BIT_ODDPARITY</code></td> </tr> <tr> <td>9-bit data, no parity</td> <td><code>_UART_9BIT_NOPARITY</code></td> </tr> </tbody> </table> <p>- <code>stop_bits</code>: stop bit selection parameter.</p> <p>Valid values:</p> <table border="1" data-bbox="396 987 931 1137"> <thead> <tr> <th colspan="2">Stop bits</th> </tr> <tr> <th>Description</th> <th>Predefined library const</th> </tr> </thead> <tbody> <tr> <td>One stop bit</td> <td><code>_UART_ONE_STOPBIT</code></td> </tr> <tr> <td>Two stop bit</td> <td><code>_UART_TWO_STOPBITS</code></td> </tr> </tbody> </table> <p>- <code>high_low_speed</code>: high/low speed selection parameter. Available only for dsPIC33 and PIC24 MCUs.</p> <p>Valid values:</p> <table border="1" data-bbox="396 1342 962 1492"> <thead> <tr> <th colspan="2">High/Low Speed</th> </tr> <tr> <th>Description</th> <th>Predefined library const</th> </tr> </thead> <tbody> <tr> <td>Low Speed UART</td> <td><code>_UART_LOW_SPEED</code></td> </tr> <tr> <td>Hi Speed UART</td> <td><code>_UART_HI_SPEED</code></td> </tr> </tbody> </table>	Data/Parity Mode		Description	Predefined library const	8-bit data, no parity	<code>_UART_8BIT_NOPARITY</code>	8-bit data, even parity	<code>_UART_8BIT_EVENPARITY</code>	8-bit data, odd parity	<code>_UART_8BIT_ODDPARITY</code>	9-bit data, no parity	<code>_UART_9BIT_NOPARITY</code>	Stop bits		Description	Predefined library const	One stop bit	<code>_UART_ONE_STOPBIT</code>	Two stop bit	<code>_UART_TWO_STOPBITS</code>	High/Low Speed		Description	Predefined library const	Low Speed UART	<code>_UART_LOW_SPEED</code>	Hi Speed UART	<code>_UART_HI_SPEED</code>
Data/Parity Mode																													
Description	Predefined library const																												
8-bit data, no parity	<code>_UART_8BIT_NOPARITY</code>																												
8-bit data, even parity	<code>_UART_8BIT_EVENPARITY</code>																												
8-bit data, odd parity	<code>_UART_8BIT_ODDPARITY</code>																												
9-bit data, no parity	<code>_UART_9BIT_NOPARITY</code>																												
Stop bits																													
Description	Predefined library const																												
One stop bit	<code>_UART_ONE_STOPBIT</code>																												
Two stop bit	<code>_UART_TWO_STOPBITS</code>																												
High/Low Speed																													
Description	Predefined library const																												
Low Speed UART	<code>_UART_LOW_SPEED</code>																												
Hi Speed UART	<code>_UART_HI_SPEED</code>																												

Returns	Nothing.
Requires	Routine requires the UART module.
Example	<pre><i>// dsPIC30 family example</i> <i>// Initialize hardware UART1 module and establish communication at 2400 bps,</i> <i>8-bit data, even parity and 2 STOP bits</i> UART1_Init_Advanced(2400, 2, 1); <i>// dsPIC33 and PIC24 family example</i> <i>// Initialize hardware UART2 module and establish communication at 2400 bps,</i> <i>8-bit data, even parity, 2 STOP bits and high speed baud rate calculations</i> UART2_Init_Advanced(2400, 2, 1, 1);</pre>
Notes	<p>Refer to the device data sheet for baud rates allowed for specific Fosc.</p> <p>UART library routines require you to specify the module you want to use. To select the desired UART module, simply change the letter x in the routine prototype for a number from 1 to 4.</p> <p>Switching between the UART modules in the UART library is done by the UART_Set_Active function (UART modules have to be previously initialized).</p> <p>Number of UART modules per MCU differs from chip to chip. Please, read the appropriate datasheet before utilizing this library.</p>

UARTx_Data_Ready

Prototype	<code>unsigned UARTx_Data_Ready();</code>
Description	The function tests if data in receive buffer is ready for reading.
Parameters	None.
Returns	- 1 if data is ready for reading - 0 if there is no data in the receive register
Requires	Routine requires at least one UART module. Used UART module must be initialized before using this routine. See UARTx_Init and UARTx_Init_Advanced routines.
Example	<pre>unsigned receive; ... // read data if ready if (UART1_Data_Ready()) receive = UART1_Read();</pre>
Notes	UART library routines require you to specify the module you want to use. To select the desired UART module, simply change the letter x in the routine prototype for a number from 1 to 4 . Number of UART modules per MCU differs from chip to chip. Please, read the appropriate datasheet before utilizing this library.

UARTx_Tx_Idle

Prototype	<code>char UARTx_Tx_Idle();</code>
Description	Use the function to test if the transmit shift register is empty or not.
Parameters	None.
Returns	- 1 if the data has been transmitted - 0 otherwise
Requires	Routine requires at least one UART module. Used UART module must be initialized before using this routine. See UARTx_Init and UARTx_Init_Advanced routines.
Example	<pre>// If the previous data has been shifted out, send next data: if (UART1_Tx_Idle() == 1) { UART1_Write(_data); }</pre>
Notes	UART library routines require you to specify the module you want to use. To select the desired UART module, simply change the letter x in the routine prototype for a number from 1 to 4 . Number of UART modules per MCU differs from chip to chip. Please, read the appropriate datasheet before utilizing this library.

UARTx_Read

Prototype	<code>unsigned UARTx_Read();</code>
Description	The function receives a byte via UART. Use the <code>UARTx_Data_Ready</code> function to test if data is ready first.
Parameters	None.
Returns	Received byte.
Requires	Routine requires at least one UART module. Used UART module must be initialized before using this routine. See <code>UARTx_Init</code> and <code>UARTx_Init_Advanced</code> routines.
Example	<pre> unsigned receive; ... // read data if ready if (UART1_Data_Ready()) receive = UART1_Read(); </pre>
Notes	UART library routines require you to specify the module you want to use. To select the desired UART module, simply change the letter x in the routine prototype for a number from 1 to 4 . Number of UART modules per MCU differs from chip to chip. Please, read the appropriate datasheet before utilizing this library.

UARTx_Read_Text

Prototype	<code>void UARTx_Read_Text(char *Output, char *Delimiter, char Attempts);</code>
Description	<p>Reads characters received via UART until the delimiter sequence is detected. The read sequence is stored in the parameter <code>output</code>; delimiter sequence is stored in the parameter <code>delimiter</code>.</p> <p>This is a blocking call: the delimiter sequence is expected, otherwise the procedure exits (if the delimiter is not found).</p>
Parameters	<ul style="list-style-type: none"> - <code>Output</code>: received text - <code>Delimiter</code>: sequence of characters that identifies the end of a received string - <code>Attempts</code>: defines number of received characters in which <code>Delimiter</code> sequence is expected. If <code>Attempts</code> is set to 255, this routine will continuously try to detect the <code>Delimiter</code> sequence.
Returns	Nothing.
Requires	<p>Routine requires at least one UART module.</p> <p>Used UART module must be initialized before using this routine. See <code>UARTx_Init</code> and <code>UARTx_Init_Advanced</code> routines.</p>
Example	<p>Read text until the sequence "OK" is received, and send back what's been received:</p> <pre> UART1_Init(4800); // initialize UART1 module Delay_ms(100); while (1) { if (UART1_Data_Ready() == 1) { // if data is received UART1_Read_Text(output, "OK", 10); // reads text until 'OK' is found UART1_Write_Text(output); // sends back text } } </pre>
Notes	<p>UART library routines require you to specify the module you want to use. To select the desired UART module, simply change the letter x in the routine prototype for a number from 1 to 4.</p> <p>Number of UART modules per MCU differs from chip to chip. Please, read the appropriate datasheet before utilizing this library.</p>

UARTx_Write

Prototype	<code>void UARTx_Write(unsigned char data);</code>
Description	The function transmits a byte via the UART module.
Parameters	- <code>data</code> : data to be sent
Returns	Nothing.
Requires	Routine requires at least one UART module. Used UART module must be initialized before using this routine. See <code>UARTx_Init</code> and <code>UARTx_Init_Advanced</code> routines.
Example	<pre>unsigned char data = 0x1E; ... UART1_Write(data);</pre>
Notes	UART library routines require you to specify the module you want to use. To select the desired UART module, simply change the letter x in the routine prototype for a number from 1 to 4 . Number of UART modules per MCU differs from chip to chip. Please, read the appropriate datasheet before utilizing this library.

UARTx_Write_Text

Prototype	<code>void UARTx_Write_Text(char * UART_text);</code>
Description	Sends text via UART. Text should be zero terminated.
Parameters	- <code>UART_text</code> : text to be sent
Returns	Nothing.
Requires	Routine requires at least one UART module. Used UART module must be initialized before using this routine. See <code>UARTx_Init</code> and <code>UARTx_Init_Advanced</code> routines.
Example	Read text until the sequence "OK" is received, and send back what's been received: <pre> UART1_Init(4800); //initialize UART1 module Delay_ms(100); while (1) { if (UART1_Data_Ready() == 1) { // if data is received UART1_Read_Text(output, "OK", 10); // reads text until 'OK' is found UART1_Write_Text(output); // sends back text } } </pre>
Notes	UART library routines require you to specify the module you want to use. To select the desired UART module, simply change the letter x in the routine prototype for a number from 1 to 4 . Number of UART modules per MCU differs from chip to chip. Please, read the appropriate datasheet before utilizing this library.

UART_Set_Active

Prototype	<code>void UART_Set_Active(unsigned (*read_ptr)(), void (*write_ptr)(unsigned char _data), unsigned (*ready_ptr)(), unsigned (*tx_idle_ptr)());</code>
Description	Sets active UART module which will be used by UARTx_Data_Ready, UARTx_Read and UARTx_Write routines.
Parameters	Parameters: <ul style="list-style-type: none"> - <code>read_ptr</code>: UARTx_Read handler - <code>write_ptr</code>: UARTx_Write handler - <code>ready_ptr</code>: UARTx_Data_Ready handler - <code>tx_idle_ptr</code>: UARTx_Tx_Idle handler
Returns	Nothing.
Requires	Routine is available only for MCUs with multiple UART modules. Used UART module must be initialized before using this routine. See UARTx_Init and UARTx_Init_Advanced routines.
Example	<pre> UART1_Init(9600); // initialize UART1 module UART2_Init(9600); // initialize UART2 module RS485Master_Init(); // initialize MCU as Master UART_Set_Active(&UART1_Read, &UART1_Write, &UART1_Data_Ready, &UART1_Tx_Idle); // set UART1 active RS485Master_Send(dat,1,160); // send message through UART1 UART_Set_Active(&UART2_Read, &UART2_Write, &UART2_Data_Ready, &UART2_Tx_Idle); // set UART2 active RS485Master_Send(dat,1,160); // send through UART2 </pre>
Notes	None.

Library Example

This example demonstrates simple data exchange via UART. If MCU is connected to the PC, you can test the example from the mikroC PRO for dsPIC30/33 and PIC24 USART communication terminal, launch it from the drop-down menu **Tools > USART Terminal** or simply click the USART Terminal icon .

Copy Code To Clipboard

```
char uart_rd;

void main() {

    UART1_Init(9600);           // Initialize UART module at 9600 bps
    Delay_ms(100);             // Wait for UART module to stabilize

    // U1MODEbits.ALTIO = 1; // un-comment this line to have Rx and Tx pins on their
    // alternate               // locations. This is used to free the pins for other module,
    // namely the SPI.

    UART1_Write_Text("Start");
    UART1_Write(10);
    UART1_Write(13);

    while (1) {                // Endless loop
        if (UART1_Data_Ready()) { // If data is received,
            uart_rd = UART1_Read(); // read the received data,
            UART1_Write(uart_rd);   // and send data via UART
        }
    }
}
```

USB Library

Universal Serial Bus (USB) provides a serial bus standard for connecting a wide variety of devices, including computers, cell phones, game consoles, PDA's, etc.

USB Library contains HID routines that support HID class devices, and also the generic routines that can be used with vendor specified drivers.

USB HID Class

The HID class consists primarily of devices that are used by humans to control the operation of computer systems. Typical examples of HID class devices include:

- Keyboards and pointing devices, for example: standard mouse devices, trackballs, and joysticks.
- Front-panel controls, for example: knobs, switches, buttons, and sliders.
- Controls that might be found on devices such as telephones, VCR remote controls, games or simulation devices, for example: data gloves, throttles, steering wheels, and rudder pedals.
- Devices that may not require human interaction but provide data in a similar format to HID class devices, for example, bar-code readers, thermometers, or voltmeters.

Many typical HID class devices include indicators, specialized displays, audio feedback, and force or tactile feedback. Therefore, the HID class definition includes support for various types of output directed to the end user.

Descriptor File

Each project based on the USB library should include a descriptor source file which contains vendor id and name, product id and name, report length, and other relevant information. To create a descriptor file, use the integrated USB HID terminal of mikroC PRO for dsPIC30/33 and PIC24(**Tools** > **USB HID Terminal**). The default name for descriptor file is `USBdsc.c`, but you may rename it.

Library Routines

- HID_Enable
- HID_Read
- HID_Write
- HID_Disable
- USB_Interrupt_Proc
- USB_Polling_Proc
- Gen_Enable
- Gen_Read
- Gen_Write

HID_Enable

Prototype	<code>void HID_Enable(char *readbuff, char *writebuff);</code>
Description	Enables USB HID communication.
Parameters	<ul style="list-style-type: none"> - <code>readbuff</code>: Read Buffer. - <code>writebuff</code>: Write Buffer. <p>These parameters are used for HID communication.</p>
Returns	Nothing.
Requires	Nothing.
Example	<code>HID_Enable(&readbuff, &writebuff);</code>
Notes	This function needs to be called before using other routines of USB HID Library.

HID_Read

Prototype	<code>char HID_Read(void);</code>
Description	Receives message from host and stores it in the Read Buffer.
Parameters	None.
Returns	If the data reading has failed, the function returns 0. Otherwise, it returns number of characters received from the host.
Requires	USB HID needs to be enabled before using this function. See <code>HID_Enable</code> .
Example	<pre><code>// retry until success while(!HID_Read()) ;</code></pre>
Notes	None.

HID_Write

Prototype	<code>char HID_Write(char *writebuff, char len);</code>
Description	Function sends data from Write Buffer writebuff to host.
Parameters	<ul style="list-style-type: none"> - <code>writebuff</code>: Write Buffer, same parameter as used in initialization; see <code>HID_Enable</code>. - <code>len</code>: specifies a length of the data to be transmitted.
Returns	If the data transmitting has failed, the function returns 0. Otherwise, it returns number of transmitted bytes.
Requires	USB HID needs to be enabled before using this function. See <code>HID_Enable</code> .
Example	<pre><code>// retry until success while(!HID_Write(&writebuff, 64)) ;</code></pre>
Notes	Function call needs to be repeated as long as data is not successfully sent.

HID_Disable

Prototype	<code>void HID_Disable(void);</code>
Description	Disables USB HID communication.
Parameters	None.
Returns	Nothing.
Requires	USB HID needs to be enabled before using this function. See <code>HID_Enable</code> .
Example	<code>HID_Disable();</code>
Notes	None.

USB_Interrupt_Proc

Prototype	<code>void USB_Interrupt_Proc(void);</code>
Description	This routine is used for servicing various USB bus events. Should be called inside USB interrupt routine.
Parameters	None.
Returns	Nothing.
Requires	Nothing.
Example	<pre>void USB1Interrupt() iv IVT_ADDR_USB1INTERRUPT { USB_Interrupt_Proc(); }</pre>
Notes	Do not use this function with USB_Polling_Proc, only one should be used. To enable servicing through interrupt, <code>USB_INTERRUPT</code> constant should be set (it is set by default in descriptor file).

USB_Polling_Proc

Prototype	<code>void USB_Polling_Proc(void);</code>
Description	This routine is used for servicing various USB bus events. It should be periodically, preferably every 100 microseconds.
Parameters	None.
Returns	Nothing.
Requires	Nothing.
Example	<pre>while(1) { USB_Polling_Proc(); kk = HID_Read(); if (kk != 0) { for(cnt=0; cnt < 64; cnt++) writebuff[cnt]=readbuff[cnt]; HID_Write(&writebuff,64); } }</pre>
Notes	Do not use this functions with USB_Interrupt_Proc. To enable servicing by polling, <code>USB_INTERRUPT</code> constant should be set to 0 (it is located in descriptor file).

Gen_Enable

Prototype	<code>void Gen_Enable(char* readbuff, char* writebuff);</code>
Description	Initialize the USB module of the MCU.
Parameters	<ul style="list-style-type: none"> - <code>readbuff</code>: Read Buffer. - <code>writebuff</code>: Write Buffer.
Returns	Nothing.
Requires	USB needs to be enabled before using this function. See <code>HID_Enable</code> .
Example	<code>Gen_Enable(&readbuff, &writebuff);</code>
Notes	None.

Gen_Read

Prototype	<code>char Gen_Read(char *readbuff, char length, char ep);</code>
Description	Generic routine that receives the specified data from the specified endpoint.
Parameters	<ul style="list-style-type: none"> - <code>readbuff</code>: Received data. - <code>length</code>: The length of the data that you wish to receive. - <code>ep</code>: Endpoint number you want to receive the data into.
Returns	Returns the number of received bytes, otherwise 0.
Requires	USB needs to be enabled before using this function. See <code>HID_Enable</code> .
Example	<code>while (Gen_Read(readbuff, 64, 1) == 0) ;</code>
Notes	None.

Gen_Write

Prototype	<code>char Gen_Write(char* writebuff, char length, char ep);</code>
Description	Sends the specified data to the specified endpoint.
Parameters	<ul style="list-style-type: none">- <code>writebuff</code>: The data that you want to send.- <code>length</code>: the length of the data that you wish to send.- <code>ep</code>: Endpoint number you want to send the data into.
Returns	Returns the number of transmitted bytes, otherwise 0.
Requires	USB needs to be enabled before using this function. See <code>HID_Enable</code> .
Example	<pre>while (Gen_Write(writebuff, 64, 1) == 0) ;</pre>
Notes	None.

Library Example

This example establishes connection with the HID terminal that is active on the PC. Upon connection establishment, the HID Device Name will appear in the respective window. After that software will wait for data and it will return received data back. Examples uses `USBdsc.c` descriptor file, which is in the same folder, and can be created by the HID Terminal.

Copy Code To Clipboard

```
char cnt;
char readbuff[64];
char writebuff[64];

void USB1Interrupt() iv IVT_ADDR_USB1INTERRUPT {
    USB_Interrupt_Proc();
}

void main(void){
    AD1PCFGL = 0xFFFF;

    HID_Enable(&readbuff, &writebuff);

    while(1){
        while(!HID_Read())
            ;

        for(cnt=0;cnt<64;cnt++)
            writebuff[cnt]=readbuff[cnt];

        while(!HID_Write(&writebuff, 64))
            ;
    }
}
```

HW Connection

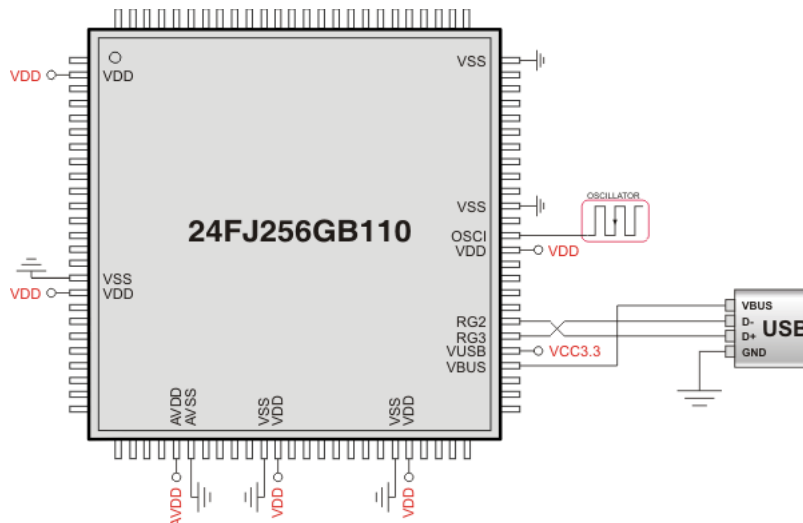

DSP Libraries

mikroC PRO for dsPIC30/33 and PIC24 includes various libraries for DSP engine. All DSP routines work with fractional Q15 format.

Digital Signal Processing Libraries

- FIR Filter Library
- IIR Filter Library
- FFT Library
- Bit Reverse Complex Library
- Vectors Library
- Matrices Library

FIR Filter Library

mikoC PRO for dsPIC30/33 and PIC24 includes a library for finite impulse response (FIR) filter. All routines work with fractional Q15 format.

A finite impulse response (FIR) filter is a type of a digital filter, whose impulse response (the filter's response to a delta function) is finite because it settles to zero in a finite number of sample intervals.

Library Routines

- FIR_Radix

FIR_Radix

Prototype	<code>unsigned FIR_Radix(unsigned FilterOrder, const unsigned *ptrCoeffs, unsigned BuffLength, unsigned *ptrInput, unsigned Index);</code>
Description	This function applies FIR filter to <code>ptrInput</code> .
Parameters	<ul style="list-style-type: none"> - <code>FilterOrder</code>: order of the filter + 1 - <code>ptrCoeffs</code>: pointer to filter coefficients in program memory - <code>BuffLength</code>: number of input samples - <code>ptrInput</code>: pointer to input samples - <code>Index</code>: index of current sample
Returns	$\sum_{k=0}^{N-1} \text{coef}[k] * \text{input}[N-k]$ with : N - buffer length k - current index
Requires	Nothing.
Example	<pre>const unsigned BUFFFER_SIZE = 32; const unsigned FILTER_ORDER = 20; const COEFF_B[FILTER_ORDER+1] = { 0x0000, 0x0048, 0x0133, 0x02D3, 0x052B, 0x0826, 0x0BA0, 0x0F62, 0x1329, 0x16AA, 0x199A, 0x16AA, 0x1329, 0x0F62, 0x0BA0, 0x0826, 0x052B, 0x02D3, 0x0133, 0x0048, 0x0000 }; ydata unsigned input[BUFFFER_SIZE]; // Input buffer unsigned inext; // Input buffer index ... unsigned CurrentValue; CurrentValue = FIR_Radix(FILTER_ORDER+1, // Filter order COEFF_B, // b coefficients of the filter BUFFFER_SIZE, // Input buffer length input, // Input buffer inext); // Current sample</pre>
Notes	Input samples must be in Y data space.

IIR Filter Library

mikroC PRO for dsPIC30/33 and PIC24 includes a library for Infinite Impulse Response (IIR) filter. All routines work with fractional Q15 format.

A infinite impulse response (IIR) filter is a type of a digital filter, whose impulse response (the filter's response to a delta function) is non-zero over an infinite length of time.

Library Routines

IIR_Radix

IIR_Radix

Prototype	<code>unsigned IIR_Radix (const int BScale, const int AScale, const signed *ptrB, const signed *ptrA, unsigned FilterOrder, unsigned *ptrInput, unsigned InputLen, unsigned *ptrOutput, unsigned Index);</code>
Description	This function applies IIR filter to <code>ptrInput</code> .
Parameters	<ul style="list-style-type: none"> - <code>BScale</code>: B scale factor. - <code>AScale</code>: A scale factor. - <code>ptrB</code>: pointer to B coefficients (in program memory). - <code>ptrA</code>: pointer to A coefficients (in program memory). - <code>FilterOrder</code>: order of the filter + 1. - <code>ptrInput</code>: address of input samples. - <code>InputLen</code>: number of samples. - <code>ptrOutput</code>: pointer to output samples. Output length is equal to Input length. - <code>Index</code>: index of current sample.
Returns	$y[n] = \sum_{k=0}^N (Acoeff[n] * x[n-k]) - \sum_{k=1}^M (Bcoef[k] * y[n-k])$
Requires	Nothing.
Example	<pre>const unsigned int BUFFER_SIZE = 8; const unsigned int FILTER_ORDER = 6; const signed int COEFF_B[FILTER_ORDER+1] = {0x0548, 0x1FAE, 0x4F34, 0x699B, 0x4F34, 0x1FAE, 0x0548}; const signed int COEFF_A[FILTER_ORDER+1] = {0x4000, 0xB3FE, 0x5389, 0xD4D8, 0x10DD, 0xFCB0, 0x0052}; const unsigned int SCALE_B = 2; const unsigned int SCALE_A = -1; unsigned int inext; // Input buffer index ydata unsigned int input[BUFFER_SIZE]; // Input buffer ydata unsigned int output[BUFFER_SIZE]; // Output buffer ... unsigned int CurrentValue; CurrentValue = IIR_Radix(SCALE_B, SCALE_A, COEFF_B, // b coefficients of the filter COEFF_A, // a coefficients of the filter FILTER_ORDER+1, // Filter order + 1 input, // Input buffer BUFFER_SIZE, // Input buffer length output, // Input buffer inext); // Current sample</pre>
Notes	Input and output samples must be in Y data space.

FFT Library

mikoC PRO for dsPIC30/33 and PIC24 includes a library for FFT calculation. All routines work with fractional Q15 format.

Library Dependency Tree



Library Routines

- FFT

FFT

Prototype	<code>void FFT(unsigned log2N, const unsigned *TwiddleFactorsAddress, unsigned *Samples);</code>
Description	<p>Function applies FFT transformation to input samples, input samples must be in Y data space.</p> $F(k) = \frac{1}{N} * \sum_{(n,k)=0}^{N-1} (f(n) * WN(kn)), \quad WN(kn) = e^{\frac{-j * 2 * \pi * k * n}{N}}$ <ul style="list-style-type: none"> - $f(n)$: array of complex input samples - WN: TwiddleFactors - $N = 2^m, m \in \mathbb{Z}$ <p>The amplitude of current FFT sample is calculated as:</p> $ F(k) = \sqrt{\text{Re}^2[k] + \text{Im}^2[k]}$
Parameters	<ul style="list-style-type: none"> - <code>log2N</code>: buffer length (must be the power of 2). - <code>TwiddleFactorsAddress</code>: address of constant array which contains complex twiddle factors. The array is expected to be in program memory. See Twiddle Factors for adequate array values. - <code>Samples</code>: array of input samples. Upon completion, complex array of FFT samples is placed in the <code>Samples</code> parameter.
Returns	Nothing.
Requires	Nothing.
Example	<pre> ydata unsigned InputSamples[512]; ... // Perform FFT (DFT), 7 stages, 128 samples of complex pairs FFT(8, TwiddleCoeff_256, InputSamples); </pre>
Notes	<p>Complex array of FFT samples is placed in <code>Samples</code> parameter. Input Samples are arranged in manner Re,Im,Re,Im... (where Im is always zero). Output samples are arranged in the same manner but Im parts are different from zero. Output samples are symmetrical (First half of output samples (index from 0 to N/2) is identical as second half of output samples(index from N/2 to N)).</p> <p>Input data is a complex vector such that the magnitude of the real and imaginary parts of each of its elements is less than 0.5. If greater or equal to this value the results could produce saturation. Note that the output values are scaled by a factor of 1/N, with N the length of the FFT. input is expected in natural ordering, while output is produced in bit reverse ordering.</p>

Twiddle Factors:

TwiddleCoeff_64

```
const unsigned TwiddleCoeff_64[64] = {
    0x7FFF, 0x0000, 0x7F62, 0xF374, 0x7D8A, 0xE707, 0x7A7D, 0xDAD8,
    0x7642, 0xCF04, 0x70E3, 0xC3A9, 0x6A6E, 0xB8E3, 0x62F2, 0xAECC,
    0x5A82, 0xA57E, 0x5134, 0x9D0E, 0x471D, 0x9592, 0x3C57, 0x8F1D,
    0x30FC, 0x89BE, 0x2528, 0x8583, 0x18F9, 0x8276, 0x0C8C, 0x809E,
    0x0000, 0x8000, 0xF374, 0x809E, 0xE707, 0x8276, 0xDAD8, 0x8583,
    0xCF04, 0x89BE, 0xC3A9, 0x8F1D, 0xB8E3, 0x9592, 0xAECC, 0x9D0E,
    0xA57E, 0xA57E, 0x9D0E, 0xAECC, 0x9592, 0xB8E3, 0x8F1D, 0xC3A9,
    0x89BE, 0xCF04, 0x8583, 0xDAD8, 0x8276, 0xE707, 0x809E, 0xF374};
```

TwiddleCoeff_128

```
const unsigned TwiddleCoeff_128[128] = {
    0x7FFF, 0x0000, 0x7FD9, 0xF9B8, 0x7F62, 0xF374, 0x7E9D, 0xED38,
    0x7D8A, 0xE707, 0x7C2A, 0xE0E6, 0x7A7D, 0xDAD8, 0x7885, 0xD4E1,
    0x7642, 0xCF04, 0x73B6, 0xC946, 0x70E3, 0xC3A9, 0x6DCA, 0xBE32,
    0x6A6E, 0xB8E3, 0x66D0, 0xB3C0, 0x62F2, 0xAECC, 0x5ED7, 0xAA0A,
    0x5A82, 0xA57E, 0x55F6, 0xA129, 0x5134, 0x9D0E, 0x4C40, 0x9930,
    0x471D, 0x9592, 0x41CE, 0x9236, 0x3C57, 0x8F1D, 0x36BA, 0x8C4A,
    0x30FC, 0x89BE, 0x2B1F, 0x877B, 0x2528, 0x8583, 0x1F1A, 0x83D6,
    0x18F9, 0x8276, 0x12C8, 0x8163, 0x0C8C, 0x809E, 0x0648, 0x8027,
    0x0000, 0x8000, 0xF9B8, 0x8027, 0xF374, 0x809E, 0xED38, 0x8163,
    0xE707, 0x8276, 0xE0E6, 0x83D6, 0xDAD8, 0x8583, 0xD4E1, 0x877B,
    0xCF04, 0x89BE, 0xC946, 0x8C4A, 0xC3A9, 0x8F1D, 0xBE32, 0x9236,
    0xB8E3, 0x9592, 0xB3C0, 0x9930, 0xAECC, 0x9D0E, 0xAA0A, 0xA129,
    0xA57E, 0xA57E, 0xA129, 0xAA0A, 0x9D0E, 0xAECC, 0x9930, 0xB3C0,
    0x9592, 0xB8E3, 0x9236, 0xBE32, 0x8F1D, 0xC3A9, 0x8C4A, 0xC946,
    0x89BE, 0xCF04, 0x877B, 0xD4E1, 0x8583, 0xDAD8, 0x83D6, 0xE0E6,
    0x8276, 0xE707, 0x8163, 0xED38, 0x809E, 0xF374, 0x8027, 0xF9B8};
```

TwiddleCoeff_256

```

const unsigned TwiddleCoeff_256[256] = {
    0x7FFF, 0x0000, 0x7FF6, 0xFCDC, 0x7FD9, 0xF9B8, 0x7FA7, 0xF695,
    0x7F62, 0xF374, 0x7F0A, 0xF055, 0x7E9D, 0xED38, 0x7E1E, 0xEA1E,
    0x7D8A, 0xE707, 0x7CE4, 0xE3F4, 0x7C2A, 0xE0E6, 0x7B5D, 0xDDCC,
    0x7A7D, 0xDAD8, 0x798A, 0xD7D9, 0x7885, 0xD4E1, 0x776C, 0xD1EF,
    0x7642, 0xCF04, 0x7505, 0xCC21, 0x73B6, 0xC946, 0x7255, 0xC673,
    0x70E3, 0xC3A9, 0x6F5F, 0xC0E9, 0x6DCA, 0xBE32, 0x6C24, 0xBB85,
    0x6A6E, 0xB8E3, 0x68A7, 0xB64C, 0x66D0, 0xB3C0, 0x64E9, 0xB140,
    0x62F2, 0xAECC, 0x60EC, 0xAC65, 0x5ED7, 0xAA0A, 0x5CB4, 0xA7BD,
    0x5A82, 0xA57E, 0x5843, 0xA34C, 0x55F6, 0xA129, 0x539B, 0x9F14,
    0x5134, 0x9D0E, 0x4EC0, 0x9B17, 0x4C40, 0x9930, 0x49B4, 0x9759,
    0x471D, 0x9592, 0x447B, 0x93DC, 0x41CE, 0x9236, 0x3F17, 0x90A1,
    0x3C57, 0x8F1D, 0x398D, 0x8DAB, 0x36BA, 0x8C4A, 0x33DF, 0x8AFB,
    0x30FC, 0x89BE, 0x2E11, 0x8894, 0x2B1F, 0x877B, 0x2827, 0x8676,
    0x2528, 0x8583, 0x2224, 0x84A3, 0x1F1A, 0x83D6, 0x1C0C, 0x831C,
    0x18F9, 0x8276, 0x15E2, 0x81E2, 0x12C8, 0x8163, 0x0FAB, 0x80F6,
    0x0C8C, 0x809E, 0x096B, 0x8059, 0x0648, 0x8027, 0x0324, 0x800A,
    0x0000, 0x8000, 0xFCDC, 0x800A, 0xF9B8, 0x8027, 0xF695, 0x8059,
    0xF374, 0x809E, 0xF055, 0x80F6, 0xED38, 0x8163, 0xEA1E, 0x81E2,
    0xE707, 0x8276, 0xE3F4, 0x831C, 0xE0E6, 0x83D6, 0xDDCC, 0x84A3,
    0xDAD8, 0x8583, 0xD7D9, 0x8676, 0xD4E1, 0x877B, 0xD1EF, 0x8894,
    0xCF04, 0x89BE, 0xCC21, 0x8AFB, 0xC946, 0x8C4A, 0xC673, 0x8DAB,
    0xC3A9, 0x8F1D, 0xC0E9, 0x90A1, 0xBE32, 0x9236, 0xBB85, 0x93DC,
    0xB8E3, 0x9592, 0xB64C, 0x9759, 0xB3C0, 0x9930, 0xB140, 0x9B17,
    0xAECC, 0x9D0E, 0xAC65, 0x9F14, 0xAA0A, 0xA129, 0xA7BD, 0xA34C,
    0xA57E, 0xA57E, 0xA34C, 0xA7BD, 0xA129, 0xAA0A, 0x9F14, 0xAC65,
    0x9D0E, 0xAECC, 0x9B17, 0xB140, 0x9930, 0xB3C0, 0x9759, 0xB64C,
    0x9592, 0xB8E3, 0x93DC, 0xBB85, 0x9236, 0xBE32, 0x90A1, 0xC0E9,
    0x8F1D, 0xC3A9, 0x8DAB, 0xC673, 0x8C4A, 0xC946, 0x8AFB, 0xCC21,
    0x89BE, 0xCF04, 0x8894, 0xD1EF, 0x877B, 0xD4E1, 0x8676, 0xD7D9,
    0x8583, 0xDAD8, 0x84A3, 0xDDCC, 0x83D6, 0xE0E6, 0x831C, 0xE3F4,
    0x8276, 0xE707, 0x81E2, 0xEA1E, 0x8163, 0xED38, 0x80F6, 0xF055,
    0x809E, 0xF374, 0x8059, 0xF695, 0x8027, 0xF9B8, 0x800A, 0xFCDC};

```

TwiddleCoeff_512

```

const unsigned TwiddleCoeff_512[512] = {
    0x7FFF, 0x0000, 0x7FFE, 0xFE6E, 0x7FF6, 0xFCDC, 0x7FEA, 0xFB4A,
    0x7FD9, 0xF9B8, 0x7FC2, 0xF827, 0x7FA7, 0xF695, 0x7F87, 0xF505,
    0x7F62, 0xF374, 0x7F38, 0xF1E4, 0x7F0A, 0xF055, 0x7ED6, 0xEEC6,
    0x7E9D, 0xED38, 0x7E60, 0xEBAB, 0x7E1E, 0xEA1E, 0x7DD6, 0xE892,
    0x7D8A, 0xE707, 0x7D3A, 0xE57D, 0x7CE4, 0xE3F4, 0x7C89, 0xE26D,
    0x7C2A, 0xE0E6, 0x7BC6, 0xDF61, 0x7B5D, 0xDDCC, 0x7AEF, 0xDC59,
    0x7A7D, 0xDAD8, 0x7A06, 0xD958, 0x798A, 0xD7D9, 0x790A, 0xD65C,
    0x7885, 0xD4E1, 0x77FB, 0xD367, 0x776C, 0xD1EF, 0x76D9, 0xD079,
    0x7642, 0xCF04, 0x75A6, 0xCD92, 0x7505, 0xCC21, 0x7460, 0xCAB2,
    0x73B6, 0xC946, 0x7308, 0xC7DB, 0x7255, 0xC673, 0x719E, 0xC50D,
    0x70E3, 0xC3A9, 0x7023, 0xC248, 0x6F5F, 0xC0E9, 0x6E97, 0xBF8C,
    0x6DCA, 0xBE32, 0x6CF9, 0xBCDA, 0x6C24, 0xBB85, 0x6B4B, 0xBA33,

```

```
0x6A6E, 0xB8E3, 0x698C, 0xB796, 0x68A7, 0xB64C, 0x67BD, 0xB505,  
0x66D0, 0xB3C0, 0x65DE, 0xB27F, 0x64E9, 0xB140, 0x63EF, 0xB005,  
0x62F2, 0xAECC, 0x61F1, 0xAD97, 0x60EC, 0xAC65, 0x5FE4, 0xAB36,  
0x5ED7, 0xAA0A, 0x5DC8, 0xA8E2, 0x5CB4, 0xA7BD, 0x5B9D, 0xA69C,  
0x5A82, 0xA57E, 0x5964, 0xA463, 0x5843, 0xA34C, 0x571E, 0xA238,  
0x55F6, 0xA129, 0x54CA, 0xA01C, 0x539B, 0x9F14, 0x5269, 0x9E0F,  
0x5134, 0x9D0E, 0x4FFB, 0x9C11, 0x4EC0, 0x9B17, 0x4D81, 0x9A22,  
0x4C40, 0x9930, 0x4AFB, 0x9843, 0x49B4, 0x9759, 0x486A, 0x9674,  
0x471D, 0x9592, 0x45CD, 0x94B5, 0x447B, 0x93DC, 0x4326, 0x9307,  
0x41CE, 0x9236, 0x4074, 0x9169, 0x3F17, 0x90A1, 0x3DB8, 0x8FDD,  
0x3C57, 0x8F1D, 0x3AF3, 0x8E62, 0x398D, 0x8DAB, 0x3825, 0x8CF8,  
0x36BA, 0x8C4A, 0x354E, 0x8BA0, 0x33DF, 0x8AFB, 0x326E, 0x8A5A,  
0x30FC, 0x89BE, 0x2F87, 0x8927, 0x2E11, 0x8894, 0x2C99, 0x8805,  
0x2B1F, 0x877B, 0x29A4, 0x86F6, 0x2827, 0x8676, 0x26A8, 0x85FA,  
0x2528, 0x8583, 0x23A7, 0x8511, 0x2224, 0x84A3, 0x209F, 0x843A,  
0x1F1A, 0x83D6, 0x1D93, 0x8377, 0x1C0C, 0x831C, 0x1A83, 0x82C6,  
0x18F9, 0x8276, 0x176E, 0x822A, 0x15E2, 0x81E2, 0x1455, 0x81A0,  
0x12C8, 0x8163, 0x113A, 0x812A, 0x0FAB, 0x80F6, 0x0E1C, 0x80C8,  
0x0C8C, 0x809E, 0x0AFB, 0x8079, 0x096B, 0x8059, 0x07D9, 0x803E,  
0x0648, 0x8027, 0x04B6, 0x8016, 0x0324, 0x800A, 0x0192, 0x8002,  
0x0000, 0x8000, 0xFE6E, 0x8002, 0xFCDC, 0x800A, 0xFB4A, 0x8016,  
0xF9B8, 0x8027, 0xF827, 0x803E, 0xF695, 0x8059, 0xF505, 0x8079,  
0xF374, 0x809E, 0xF1E4, 0x80C8, 0xF055, 0x80F6, 0xEEC6, 0x812A,  
0xED38, 0x8163, 0xEBAB, 0x81A0, 0xEA1E, 0x81E2, 0xE892, 0x822A,  
0xE707, 0x8276, 0xE57D, 0x82C6, 0xE3F4, 0x831C, 0xE26D, 0x8377,  
0xE0E6, 0x83D6, 0xDF61, 0x843A, 0xDDDC, 0x84A3, 0xDC59, 0x8511,  
0xDAD8, 0x8583, 0xD958, 0x85FA, 0xD7D9, 0x8676, 0xD65C, 0x86F6,  
0xD4E1, 0x877B, 0xD367, 0x8805, 0xD1EF, 0x8894, 0xD079, 0x8927,  
0xCF04, 0x89BE, 0xCD92, 0x8A5A, 0xCC21, 0x8AFB, 0xCAB2, 0x8BA0,  
0xC946, 0x8C4A, 0xC7DB, 0x8CF8, 0xC673, 0x8DAB, 0xC50D, 0x8E62,  
0xC3A9, 0x8F1D, 0xC248, 0x8FDD, 0xC0E9, 0x90A1, 0xBF8C, 0x9169,  
0xBE32, 0x9236, 0xBCDA, 0x9307, 0xBB85, 0x93DC, 0xBA33, 0x94B5,  
0xB8E3, 0x9592, 0xB796, 0x9674, 0xB64C, 0x9759, 0xB505, 0x9843,  
0xB3C0, 0x9930, 0xB27F, 0x9A22, 0xB140, 0x9B17, 0xB005, 0x9C11,  
0xAECC, 0x9D0E, 0xAD97, 0x9E0F, 0xAC65, 0x9F14, 0xAB36, 0xA01C,  
0xAA0A, 0xA129, 0xA8E2, 0xA238, 0xA7BD, 0xA34C, 0xA69C, 0xA463,  
0xA57E, 0xA57E, 0xA463, 0xA69C, 0xA34C, 0xA7BD, 0xA238, 0xA8E2,  
0xA129, 0xAA0A, 0xA01C, 0xAB36, 0x9F14, 0xAC65, 0x9E0F, 0xAD97,  
0x9D0E, 0xAECC, 0x9C11, 0xB005, 0x9B17, 0xB140, 0x9A22, 0xB27F,  
0x9930, 0xB3C0, 0x9843, 0xB505, 0x9759, 0xB64C, 0x9674, 0xB796,  
0x9592, 0xB8E3, 0x94B5, 0xBA33, 0x93DC, 0xBB85, 0x9307, 0xBCDA,  
0x9236, 0xBE32, 0x9169, 0xBF8C, 0x90A1, 0xC0E9, 0x8FDD, 0xC248,  
0x8F1D, 0xC3A9, 0x8E62, 0xC50D, 0x8DAB, 0xC673, 0x8CF8, 0xC7DB,  
0x8C4A, 0xC946, 0x8BA0, 0xCAB2, 0x8AFB, 0xCC21, 0x8A5A, 0xCD92,  
0x89BE, 0xCF04, 0x8927, 0xD079, 0x8894, 0xD1EF, 0x8805, 0xD367,  
0x877B, 0xD4E1, 0x86F6, 0xD65C, 0x8676, 0xD7D9, 0x85FA, 0xD958,  
0x8583, 0xDAD8, 0x8511, 0xDC59, 0x84A3, 0xDDDC, 0x843A, 0xDF61,  
0x83D6, 0xE0E6, 0x8377, 0xE26D, 0x831C, 0xE3F4, 0x82C6, 0xE57D,  
0x8276, 0xE707, 0x822A, 0xE892, 0x81E2, 0xEA1E, 0x81A0, 0xEBAB,  
0x8163, 0xED38, 0x812A, 0xEEC6, 0x80F6, 0xF055, 0x80C8, 0xF1E4,  
0x809E, 0xF374, 0x8079, 0xF505, 0x8059, 0xF695, 0x803E, 0xF827,  
0x8027, 0xF9B8, 0x8016, 0xFB4A, 0x800A, 0xFCDC, 0x8002, 0xFE6E};
```

Bit Reverse Complex Library

mikroC PRO for dsPIC30/33 and PIC24 includes a Bit Reverse Complex Library for DSP engine. All routines work with fractional Q15 format.

Library Routines

- BitReverseComplex

BitReverseComplex

Prototype	<code>void BitReverseComplex(unsigned log2N, unsigned *ReIm);</code>
Description	This function does Complex (in-place) Bit Reverse re-organization.
Parameters	<ul style="list-style-type: none"> - N: buffer length (must be the power of 2). - ReIm: output sample(from FFT).
Returns	Nothing.
Requires	Nothing.
Example	<pre>ydata unsigned InputSamples[512]; ... // Perform FFT (DFT), 7 stages, 128 samples of complex pairs // Twiddle factors are taken from the <TwiddleFactors.c> FFT(8, TwiddleCoeff_256, InputSamples); // DFT butterfly algorythm bit-reverses output samples. // We have to restore them in natural order BitReverseComplex(8, InputSamples);</pre>
Notes	Input samples must be in Y data space.

Vectors Library

mikroC PRO for dsPIC30/33 and PIC24 includes a library for working and using vectors. All routines work with fractional Q15 format.

Library Routines

- Vector_Set
- Vector_Power
- Vector_Subtract
- Vector_Scale
- Vector_Negate
- Vector_Multiply
- Vector_Min
- Vector_Max
- Vector_Dot
- Vector_Correlate
- Vector_Convolve
- Vector_Add

Vector_Set

Prototype	<code>void Vector_Set(unsigned *input, unsigned size, unsigned value);</code>
Description	Sets <code>size</code> elements of <code>input</code> to <code>value</code> , starting from the first element.
Parameters	<ul style="list-style-type: none"> - <code>input</code>: pointer to original vector - <code>size</code>: number of vector elements - <code>value</code>: value written to the elements
Returns	Nothing.
Requires	Nothing.
Example	<pre>unsigned vec2[3] = {1,1,1}; Vector_Set(vec2, 3, 0x4000);</pre>
Notes	<ul style="list-style-type: none"> - <code>size</code> must be > 0 - Length of <code>input</code> is limited by available RAM

Vector_Power

Prototype	<code>unsigned Vector_Power(unsigned numElems, unsigned *srcV);</code>
Description	Function returns result of power value (powVal) in radix point 1.15
Parameters	<ul style="list-style-type: none"> - <code>numElems</code>: number elements in vector(s) - <code>srcV</code>: pointer to source vector
Returns	$\text{powVal} = \sum_{n=0}^{\text{numElems}-1} (\text{srcV}[n] * \text{srcV}[n])$
Requires	Nothing.
Example	<pre>unsigned vec1[3] = {1,2,3}; Vector_Power(3, vec1);</pre>
Notes	<ul style="list-style-type: none"> - [W0..W2] used, not restored - [W4] used, not restored - AccuA used, not restored - CORCON saved, used, restored

Vector_Subtract

Prototype	<code>void Vector_Subtract(unsigned *dest, unsigned *v1, unsigned *v2, unsigned numElems);</code>
Description	<p>This function does subtraction of two vectors.</p> $\text{dstV}[n] = \text{v1}[n] - \text{v2}[n], n \in [0, \text{numElems}-1]$
Parameters	<ul style="list-style-type: none"> - <code>dest</code>: result vector - <code>v1</code>: first vector - <code>v2</code>: second vector - <code>numElems</code>: must be less or equal to minimum size of two vectors.
Returns	Nothing.
Requires	Nothing.
Example	<pre>unsigned vec1[3] = {1,2,3}; unsigned vec2[3] = {1,1,1}; unsigned vecDest[3]; Vector_Subtract(vecDest, vec1, vec2, 3);</pre>
Notes	<ul style="list-style-type: none"> - AccuA used, not restored. - CORCON saved, used, restored.

Vector_Scale

Prototype	<code>void Vector_Scale(unsigned N, int ScaleValue, unsigned *SrcVector, unsigned *DestVector);</code>
Description	This function does vector scaling with scale value. $dstV[n] = sclVal * srcV[n]$, $n \in [0, numElems-1]$
Parameters	<ul style="list-style-type: none"> - N: buffer length (number of elements to be scaled) - ScaleValue: scale value - SrcVector: pointer to original vector - DestVector: pointer to scaled vector
Returns	Nothing.
Requires	Nothing.
Example	<pre>unsigned vec1[3] = {1,2,3}; unsigned vecDest[3]; Vector_Scale(3, 2, vec1, vecDest);</pre>
Notes	<ul style="list-style-type: none"> - [W0..W5] used, not restored - AccuA used, not restored - CORCON saved, used, restored

Vector_Negate

Prototype	<code>void Vector_Negate(unsigned *srcVector, unsigned *DestVector, unsigned numElems);</code>
Description	This function does negation of vector. $dstV[n] = (-1)*srcV1[n] + 0$, $n \in [0, numElems]$
Parameters	<ul style="list-style-type: none"> - srcVector: pointer to original vector - destVector: pointer to result vector - numElems: number of elements in vector(s)
Returns	Nothing.
Requires	Nothing.
Example	<pre>unsigned vecDest[3]; unsigned vec1[3] = {1,2,3}; Vector_Negate(vec1, vecDest, 3);</pre>
Notes	<ul style="list-style-type: none"> - Negate of 0x8000 is 0x7FFF - [W0..W5] used, not restored - AccuA used, not restored - CORCON saved, used, restored

Vector_Multiply

Prototype	<code>void Vector_Multiply(unsigned *v1, unsigned *v2, unsigned *dest, unsigned numElems);</code>
Description	This function does multiplication of two vectors. <code>dstV[n] = srcV1[n] * srcV2[n], n ∈ [0, numElems-1]</code>
Parameters	<ul style="list-style-type: none"> - <code>v1</code>: pointer to first vector - <code>v2</code>: pointer to second vector - <code>dest</code>: pointer to result vector - <code>numElems</code>: number elements in vector(s) (must be less or equal to minimum size of two vectors)
Returns	Nothing.
Requires	Nothing.
Example	<pre>unsigned vec1[3] = {1,2,3}; unsigned vec2[3] = {1,1,1}; unsigned vConDest[10]; Vector_Multiply(vec1, vConDest, vec2, 3);</pre>
Notes	<ul style="list-style-type: none"> - [W0..W5] used, not restored - AccuA used, not restored - CORCON saved, used, restored

Vector_Min

Prototype	<code>unsigned Vector_Min(unsigned *Vector, unsigned numElems, unsigned *MinIndex);</code>
Description	This function finds minimal value in vector. <code>minVal = min (srcV[n]), n ∈ [0, numElems-1]</code> If <code>srcV[i] = srcV[j] = minVal</code> , and <code>i < j</code> , then <code>MinIndex = j</code> .
Parameters	<ul style="list-style-type: none"> - <code>Vector</code>: pointer to original vector - <code>numElems</code>: number of elements in vector - <code>MinIndex</code>: pointer to index of minimum value
Returns	Minimum value (<code>minVal</code>).
Requires	Nothing.
Example	<pre>unsigned vec1[3] = {1,2,3}; unsigned index; unsigned rslt; rslt = Vector_Min(vec1, 3, &index);</pre>
Notes	<ul style="list-style-type: none"> - [W0..W5] used, not restored

Vector_Max

Prototype	<code>unsigned Vector_Max(unsigned *srcV, unsigned numElems, unsigned *MaxIndex);</code>
Description	This function find maximal value in vector. <code>maxVal = max (srcV[n]), n ∈ [0, numElems-1]</code> If <code>srcV[i] = srcV[j] = maxVal</code> , and <code>i < j</code> , then <code>maxIndex = j</code> .
Parameters	<ul style="list-style-type: none"> - <code>srcV</code>: pointer to original vector - <code>numElems</code>: number of elements in vector(s) - <code>MaxIndex</code>: pointer to index of maximum value
Returns	Minimum value (<code>maxVal</code>).
Requires	Nothing.
Example	<pre> unsigned vec1[3] = {1,2,3}; unsigned index; unsigned rslt; rslt = Vector_Max(vec1, 3, &index); </pre>
Notes	- [W0..W5] used, not restored

Vector_Dot

Prototype	<code>unsigned Vector_Dot(unsigned *v1, unsigned *v2, unsigned numElems);</code>
Description	Function calculates vector dot product.
Parameters	<ul style="list-style-type: none"> - <code>v1</code>: pointer to first vector - <code>v2</code>: pointer to second vector - <code>numElems</code>: number of elements in vector(s)
Returns	Dot product value : $\text{dotVal} = \sum_{n=0}^{\text{numElems}-1} (\text{srcV1}[n] * \text{srcV2}[n])$
Requires	Nothing.
Example	<pre> unsigned vec2[3] = {1,1,1}; unsigned rslt; rslt = Vector_Dot(vec2,vec2,3); </pre>
Notes	<ul style="list-style-type: none"> - [W0..W2] used, not restored - [W4..W5] used, not restored - AccuA used, not restored - CORCON saved, used, restored

Vector_Correlate

Prototype	<code>void Vector_Correlate(unsigned *v1, unsigned *v2, unsigned *dest, unsigned numElemsV1, unsigned numElemsV2);</code>
Description	Function calculates Vector correlation (using convolution). $r[n] = \sum_{k=0}^{N-1} (x[k] * y[k+n]);$ <p>where: <code>x[n]</code> defined for $n \in [0, N)$ <code>y[n]</code> defined for $n \in [0, M), M \leq N$ <code>r[n]</code> defined for $n \in [0, N+M-1)$</p>
Parameters	<ul style="list-style-type: none"> - <code>v1</code>: pointer to first vector - <code>v2</code>: pointer to second vector - <code>dest</code>: pointer to result vector - <code>numElemsV1</code>: number of the first vector elements - <code>numElemsV2</code>: number of the second vector elements
Returns	Nothing.
Requires	Nothing.
Example	<pre>unsigned vConDest[10]; unsigned vec2[3] = {1,1,1}; Vector_Correlate(vec2,vec2,vConDest,3,3);</pre>
Notes	[W0..W7] used, not restored

Vector_Convolve

Prototype	<code>void Vector_Convolve(unsigned *v1, unsigned *v2, unsigned *dest, unsigned numElemsV1, unsigned numElemsV2);</code>
Description	<p>Function calculates Vector using convolution.</p> $y[n] = \sum_{k=0}^n (x[k]*h[n-k]), n \in [0, M)$ $y[n] = \sum_{(k=n-M+1)}^n (x[k]*h[n-k]), n \in [M, N)$ $y[n] = \sum_{k=n-M+1}^{N-1} x[k]*h[n-k], n \in [N, N+M-1)$
Parameters	<ul style="list-style-type: none"> - <code>v1</code>: pointer to first vector - <code>v2</code>: pointer to second vector - <code>dest</code>: pointer to result vector - <code>numElemsV1</code>: number of the first vector elements - <code>numElemsV2</code>: number of the second vector elements
Returns	Nothing.
Requires	Nothing.
Example	<pre> unsigned vec2[3] = {1,1,1}; unsigned vConDest2[10]; Vector_Convolve(vec2,vec2,vConDest2,3,3); </pre>
Notes	<ul style="list-style-type: none"> - [W0..W7] used, not restored - [W8..W10] saved, used, restored - AccuA used, not restored - CORCON saved, used, restored

Vector_Add

Prototype	<code>void Vector_Add(unsigned *dest, unsigned *v1, unsigned *v2, unsigned numElems);</code>
Description	Function calculates vector addition. <code>dstV[n] = srcV1[n] + srcV2[n]</code> , $n \in [0, \text{numElems}-1]$
Parameters	<ul style="list-style-type: none"> - <code>dest</code>: pointer to result vector - <code>v1</code>: pointer to first vector - <code>v2</code>: pointer to second vector - <code>numElemsV1</code>: number of vector(s) elements
Returns	Nothing.
Requires	Nothing.
Example	<pre> unsigned vec1[3] = {1,2,3}; unsigned vec2[3] = {1,1,1}; unsigned vecDest[3]; Vector_Add(vecDest, vec1, vec2, 3); </pre>
Notes	<ul style="list-style-type: none"> - [W0..W4] used, not restored - AccuA used, not restored - CORCON saved, used, restored

Matrices Library

mikroC PRO for dsPIC30/33 and PIC24 includes a library for operating and working with matrices. All routines work with fractional Q15 format.

Library Routines

Matrix_Transpose
 Matrix_Subtract
 Matrix_Scale
 Matrix_Multiply
 Matrix_Add

Matrix_Transpose

Prototype	<code>void Matrix_Transpose(unsigned *src, unsigned *dest, unsigned numRows, unsigned numCols);</code>
Description	Function does matrix transposition. <code>dstM[i][j] = srcM[j][i]</code>
Parameters	<ul style="list-style-type: none"> - <code>src</code>: pointer to original matrix - <code>dest</code>: pointer to result matrix - <code>numRows</code>: number of rows in the source matrix - <code>numCols</code>: number of cols in the source matrix
Returns	Nothing.
Requires	Nothing.
Example	<pre>int mx1[6] = {1,2,3,4,5,6}; int mxDest[9]; Matrix_Transpose(mx1, mxDest, 2,3);</pre>
Notes	[W0..W5] used, not restored

Matrix_Subtract

Prototype	<code>void Matrix_Subtract(unsigned *src1, unsigned *src2, unsigned *dest, unsigned num_rows, unsigned num_cols);</code>
Description	Function does matrix subtraction. <code>dstM[i][j] = srcM1[i][j] - srcM2[i][j]</code>
Parameters	<ul style="list-style-type: none"> - <code>src1</code>: pointer to the first matrix - <code>src2</code>: pointer to the second matrix - <code>dest</code>: pointer to the result matrix - <code>numRows</code>: number of rows in the source matrix - <code>numCols</code>: number of cols in the source matrix
Returns	Nothing.
Requires	Nothing.
Example	<pre>int mx1[6] = {1,2,3,4,5,6}; int mx2[6] = {2,2,2,2,2,2}; int mxDest[9]; Matrix_Subtract(mx1, mx2, mxDest, 2, 3);</pre>
Notes	<ul style="list-style-type: none"> - [W0.W4] used, not restored - AccuA used, not restored - AccuB used, not restored - CORCON saved, used, restored

Matrix_Scale

Prototype	<code>void Matrix_Scale(unsigned ScaleValue, unsigned *src1, unsigned *dest, unsigned numRows, unsigned numCols);</code>
Description	Function does matrix scale. <code>dstM[i][j] = sclVal * srcM[i][j]</code>
Parameters	<ul style="list-style-type: none"> - <code>ScaleValue</code>: scale value - <code>src1</code>: pointer to the original matrix - <code>dest</code>: pointer to the result matrix - <code>numRows</code>: number of rows in the source matrix - <code>numCols</code>: number of cols in the source matrix
Returns	Nothing.
Requires	Nothing.
Example	<pre>int mx1[6] = {1,2,3,4,5,6}; int mxDest[9]; Matrix_Scale(0x4000, mx1, mxDest, 2,3);</pre>
Notes	<ul style="list-style-type: none"> - [W0.W5] used, not restored - AccuA used, not restored - CORCON saved, used, restored - <code>numRows*numCols < 2¹⁴</code>

Matrix_Multiply

Prototype	<code>void Matrix_Multiply(unsigned *src1, unsigned *src2, unsigned *dest, unsigned numRows1, unsigned numCols2, unsigned numCols1Rows2);</code>
Description	<p>Function does matrix multiplication.</p> $dstM[i][j] = \sum_{(i,j,k)} srcM1[i][k] * srcM2[k][j]$ <p>with:</p> <ul style="list-style-type: none"> i □ [0, numRows1-1] j □ [0, numCols2-1] k □ [0, numCols1Rows2-1]
Parameters	<ul style="list-style-type: none"> - <code>src1</code>: pointer to the first matrix - <code>src2</code>: pointer to the second matrix - <code>dest</code>: pointer to result matrix - <code>numRows1</code>: number of rows in the first matrix - <code>numCols2</code>: number of columns in the second matrix - <code>numCols1Rows2</code>: number of columns in the first matrix and rows in the second matrix
Returns	Nothing.
Requires	Nothing.
Example	<pre>int mx1[6] = {1,2,3,4,5,6} ; int mx2[6] = {2,2,2,2,2,2} ; int mxDest[9]; Matrix_Multiply(mx1,mx2,mxDest,2,2,3);</pre>
Notes	<ul style="list-style-type: none"> - [W0..W7] used, not restored - [W8..W13] used, and restored - AccuA used, not restored - CORCON saved, used, restored

Matrix_Add

Prototype	<code>void Matrix_Add(unsigned *src1, unsigned *src2, unsigned *dest, unsigned numRows, unsigned numCols);</code>
Description	Function does matrix addition. <code>dstM[i][j] = srcM1[i][j] + srcM2[i][j]</code>
Parameters	<ul style="list-style-type: none"> - <code>src1</code>: pointer to the first matrix - <code>src2</code>: pointer to the second matrix - <code>dest</code>: pointer to the result matrix - <code>numRows1</code>: number of rows in the first matrix - <code>numCols2</code>: number of columns in the second matrix
Returns	Nothing.
Requires	Nothing.
Example	<pre>int mx1[6] = {1,2,3,4,5,6}; int mx2[6] = {2,2,2,2,2,2}; int mxDest[9]; Matrix_Add(mx1,mx2, mxDest,2,3);</pre>
Notes	<ul style="list-style-type: none"> - [W0..W4] used, not restored - AccuA used, not restored. - CORCON saved, used, restored. - <code>numRows1*numCols2 < 2¹⁴</code>

Standard ANSI C Libraries

- ANSI C Ctype Library
- ANSI C Math Library
- ANSI C Stdlib Library
- ANSI C String Library

ANSI C Ctype Library

The mikroC PRO for dsPIC30/33 and PIC24 provides a set of standard ANSI C library functions for testing and mapping characters.

Important:

- Not all of the standard functions have been included.
- The functions have been mostly implemented according to the ANSI C standard, but certain functions have been modified in order to facilitate dsPIC30/33 and PIC24 programming. Be sure to skim through the description before using standard C functions.

Library Functions

- isalnum
- isalpha
- iscntrl
- isdigit
- isgraph
- islower
- ispunct
- isspace
- isupper
- isxdigit
- toupper
- tolower

isalnum

Prototype	<code>unsigned int isalnum(char character);</code>
Description	Function returns 1 if the <code>character</code> is alphanumeric (A-Z, a-z, 0-9), otherwise returns zero.
Example	<code>res = isalnum('o'); // returns 1</code> <code>res = isalnum('\r'); // returns 0</code>

isalpha

Prototype	<code>unsigned int isalpha(char character);</code>
Description	Function returns 1 if the <code>character</code> is alphabetic (A-Z, a-z), otherwise returns zero.
Example	<code>res = isalpha('A'); // returns 1</code> <code>res = isalpha('1'); // returns 0</code>

iscntrl

Prototype	<code>unsigned int iscntrl(char character);</code>
Description	Function returns 1 if the <code>character</code> is a control or delete character(decimal 0-31 and 127), otherwise returns zero.
Example	<code>res = iscntrl('\r'); // returns 1</code> <code>res = iscntrl('o'); // returns 0</code>

isdigit

Prototype	<code>unsigned int isdigit(char character);</code>
Description	Function returns 1 if the <code>character</code> is a digit (0-9), otherwise returns zero.
Example	<code>res = isdigit('o'); // returns 1</code> <code>res = isdigit('1'); // returns 0</code>

isgraph

Prototype	<code>unsigned int isgraph(char character);</code>
Description	Function returns 1 if the <code>character</code> is a printable, excluding the space (decimal 32), otherwise returns zero.
Example	<pre>res = isgraph('o'); // returns 1 res = isgraph(' '); // returns 0</pre>

islower

Prototype	<code>unsigned int islower(char character);</code>
Description	Function returns 1 if the <code>character</code> is a lowercase letter (a-z), otherwise returns zero.
Example	<pre>res = islower('o'); // returns 1 res = islower('A'); // returns 0</pre>

ispunct

Prototype	<code>unsigned int ispunct(char character);</code>
Description	Function returns 1 if the <code>character</code> is a punctuation (decimal 32-47, 58-63, 91-96, 123-126), otherwise returns zero.
Example	<pre>res = ispunct('.'); // returns 1 res = ispunct('1'); // returns 0</pre>

isspace

Prototype	<code>unsigned int isspace(char character);</code>
Description	Function returns 1 if the <code>character</code> is a white space (space, tab, CR, HT, VT, NL, FF), otherwise returns zero.
Example	<pre>res = isspace(' '); // returns 1 res = isspace('1'); // returns 0</pre>

isupper

Prototype	<code>unsigned int isupper(char character);</code>
Description	Function returns 1 if the <code>character</code> is an uppercase letter (A-Z), otherwise returns zero.
Example	<code>res = isupper('A'); // returns 1</code> <code>res = isupper('a'); // returns 0</code>

isxdigit

Prototype	<code>unsigned int isxdigit(char character);</code>
Description	Function returns 1 if the <code>character</code> is a hex digit (0-9, A-F, a-f), otherwise returns zero.
Example	<code>res = isxdigit('A'); // returns 1</code> <code>res = isxdigit('P'); // returns 0</code>

toupper

Prototype	<code>unsigned int toupper(char character);</code>
Description	If the <code>character</code> is a lowercase letter (a-z), the function returns an uppercase letter. Otherwise, the function returns an unchanged input parameter.
Example	<code>res = toupper('a'); // returns A</code> <code>res = toupper('B'); // returns B</code>

tolower

Prototype	<code>unsigned int tolower(char character);</code>
Description	If the <code>character</code> is an uppercase letter (A-Z), function returns a lowercase letter. Otherwise, function returns an unchanged input parameter.
Example	<code>res = tolower('A'); // returns a</code> <code>res = tolower('b'); // returns b</code>

ANSI C Math Library

The mikroC PRO for dsPIC30/33 and PIC24 provides a set of standard ANSI C library functions for floating point math handling.

Important:

- Not all of the standard functions have been included.
- The functions have been mostly implemented according to the ANSI C standard, but certain functions have been modified in order to facilitate dsPIC30/33 and PIC24 programming. Be sure to skim through the description before using standard C functions.

Library Functions

- acos
- asin
- atan
- atan2
- ceil
- cos
- cosh
- exp
- fabs
- floor
- frexp
- ldexp
- log
- log10
- modf
- pow
- sin
- sinh
- sqrt
- tan

acos

Prototype	<code>double acos(double x);</code>
Description	Function returns the arc cosine of parameter <code>x</code> ; that is, the value whose cosine is <code>x</code> . The input parameter <code>x</code> must be between -1 and 1 (inclusive). The return value is in radians, between 0 and Π (inclusive).
Example	<code>doub = acos(0.5); // doub = 1.047198</code>

asin

Prototype	<code>double asin(double x);</code>
Description	Function returns the arc sine of parameter <code>x</code> ; that is, the value whose sine is <code>x</code> . The input parameter <code>x</code> must be between -1 and 1 (inclusive). The return value is in radians, between $-\pi/2$ and $\pi/2$ (inclusive).
Example	<code>doub = asin(0.5); // doub = 5.235987e-1</code>

atan

Prototype	<code>double atan(double f);</code>
Description	Function computes the arc tangent of parameter <code>f</code> ; that is, the value whose tangent is <code>f</code> . The return value is in radians, between $-\pi/2$ and $\pi/2$ (inclusive).
Example	<code>doub = atan(1.0); // doub = 7.853982e-1</code>

atan2

Prototype	<code>double atan2(double y, double x);</code>
Description	This is the two-argument arc tangent function. It is similar to computing the arc tangent of y/x , except that the signs of both arguments are used to determine the quadrant of the result and <code>x</code> is permitted to be zero. The return value is in radians, between $-\pi$ and π (inclusive).
Example	<code>doub = atan2(2., 1.); // doub = 4.636475e-1</code>

ceil

Prototype	<code>double ceil(double x);</code>
Description	Function returns value of parameter <code>x</code> rounded up to the next whole number.
Example	<code>doub = ceil(0.5); // doub = 1.000000</code>

COS

Prototype	<code>double cos(double f);</code>
Description	Function returns the cosine of <code>f</code> in radians. The return value is from -1 to 1.
Example	<code>doub = cos(PI/3.); // doub = 0.500008</code>

cosh

Prototype	<code>double cosh(double x);</code>
Description	Function returns the hyperbolic cosine of <code>x</code> , defined mathematically as $(e^x + e^{-x}) / 2$. If the value of <code>x</code> is too large (if overflow occurs), the function fails.
Example	<code>doub = cosh(PI/3.); // doub = 1.600286</code>

exp

Prototype	<code>double exp(double x);</code>
Description	Function returns the value of e — the base of natural logarithms — raised to the power <code>x</code> (i.e. e^x).
Example	<code>doub = exp(0.5); // doub = 1.648721</code>

fabs

Prototype	<code>double fabs(double d);</code>
Description	Function returns the absolute (i.e. positive) value of <code>d</code> .
Example	<code>doub = fabs(-1.3); // doub = 1.3</code>

floor

Prototype	<code>double floor(double x);</code>
Description	Function returns the value of parameter <code>x</code> rounded down to the nearest integer.
Example	<code>doub = floor(15.258); // doub = 15.000000</code>

frexp

Prototype	<code>double frexp(double value, int *eptr);</code>
Description	Function splits a floating-point value into a normalized fraction and an integral power of 2. The return value is the normalized fraction and the integer exponent is stored in the object pointed to by <code>eptr</code> .

ldexp

Prototype	<code>double ldexp(double value, int newexp);</code>
Description	Function returns the result of multiplying the floating-point number <code>num</code> by 2 raised to the power <code>n</code> (i.e. returns $x * 2^n$).
Example	<code>doub = ldexp(2.5, 2); // doub = 10</code>

log

Prototype	<code>double log(double x);</code>
Description	Function returns the natural logarithm of <code>x</code> (i.e. $\log_e(x)$).
Example	<code>doub = log(10); // doub = 2.302585E</code>

log10

Prototype	<code>double log10(double x);</code>
Description	Function returns the base-10 logarithm of <code>x</code> (i.e. $\log_{10}(x)$).
Example	<code>doub = log10(100.); // doub = 2.000000</code>

modf

Prototype	<code>double modf(double val, double *iptr);</code>
Description	Function returns the signed fractional component of <code>val</code> , placing its whole number component into the variable pointed to by <code>iptr</code> .
Example	<code>doub = modf(6.25, &iptr); // doub = 0.25, iptr = 6.00</code>

pow

Prototype	<code>double pow(double x, double y);</code>
Description	Function returns the value of <code>x</code> raised to the power <code>y</code> (i.e. x^y). If <code>x</code> is negative, the function will automatically cast <code>y</code> into <code>unsigned long</code> .
Example	<code>doub = pow(10.,5.); // doub = 9.999984e+4</code>

sin

Prototype	<code>double sin(double f);</code>
Description	Function returns the sine of <code>f</code> in radians. The return value is from -1 to 1.
Example	<code>doub = sin(PI/2.); // doub = 1.000000</code>

sinh

Prototype	<code>double sinh(double x);</code>
Description	Function returns the hyperbolic sine of <code>x</code> , defined mathematically as $(e^x - e^{-x}) / 2$. If the value of <code>x</code> is too large (if overflow occurs), the function fails.
Example	<code>doub = sinh(PI/2.); // doub = 2.301296</code>

sqrt

Prototype	<code>double sqrt(double x);</code>
Description	Function returns the non negative square root of x .
Example	<code>doub = sqrt(10000.); // doub = 100.0000</code>

tan

Prototype	<code>double tan(double x);</code>
Description	Function returns the tangent of x in radians. The return value spans the allowed range of floating point in the mikroC PRO for dsPIC30/33 and PIC24.
Example	<code>doub = tan(PI/4.); // doub = 0.999998</code>

tanh

Prototype	<code>double tanh(double x);</code>
Description	Function returns the hyperbolic tangent of x , defined mathematically as $\sinh(x)/\cosh(x)$.
Example	<code>doub = tanh(-PI/4.); // doub = -0.655793</code>

ANSI C Stdlib Library

The mikroC PRO for dsPIC30/33 and PIC24 provides a set of standard ANSI C library functions of general utility.

Important:

- Not all of the standard functions have been included.
- The functions have been mostly implemented according to the ANSI C standard, but certain functions have been modified in order to facilitate dsPIC30/33 and PIC24 programming. Be sure to skim through the description before using standard C functions.

Library Dependency Tree



Library Functions

- abs
- atof
- atoi
- atol
- div
- ldiv
- uldiv
- labs
- max
- min
- rand
- srand
- xtoi

abs

Prototype	<code>int abs(int a);</code>
Description	Function returns the absolute (i.e. positive) value of <code>a</code> .
Example	<code>result = abs(-12); // result = 12</code>

atof

Prototype	<code>double atof(char *s);</code>
Description	Function converts the input string <code>s</code> into a double precision value and returns the value. Input string <code>s</code> should conform to the floating point literal format, with an optional whitespace at the beginning. The string will be processed one character at a time, until the function reaches a character which it doesn't recognize (including a null character).
Example	<code>doub = atof("-1.23"); // doub = -1.23</code>

atoi

Prototype	<code>int atoi(char *s);</code>
Description	Function converts the input string <code>s</code> into an integer value and returns the value. The input string <code>s</code> should consist exclusively of decimal digits, with an optional whitespace and a sign at the beginning. The string will be processed one character at a time, until the function reaches a character which it doesn't recognize (including a null character).
Example	<code>result = atoi("32000"); // result = 32000</code>

atol

Prototype	<code>long atol(char *s);</code>
Description	Function converts the input string <code>s</code> into a long integer value and returns the value. The input string <code>s</code> should consist exclusively of decimal digits, with an optional whitespace and a sign at the beginning. The string will be processed one character at a time, until the function reaches a character which it doesn't recognize (including a null character).
Example	<code>result = atol("-32560"); // result = -32560</code>

div

Prototype	<code>div_t div(int number, int denom);</code>
Description	Function computes the result of division of the numerator <code>number</code> by the denominator <code>denom</code> ; the function returns a structure of type <code>div_t</code> comprising quotient (<code>quot</code>) and remainder (<code>rem</code>), see Div Structures.
Example	<code>dt = div(1234,100);</code>

ldiv

Prototype	<code>ldiv_t ldiv(long number, long denom);</code>
Description	<p>Function is similar to the div function, except that the arguments and result structure members all have type <code>long</code>.</p> <p>Function computes the result of division of the numerator <code>number</code> by the denominator <code>denom</code>; the function returns a structure of type <code>ldiv_t</code> comprising quotient (<code>quot</code>) and remainder (<code>rem</code>), see Div Structures.</p>
Example	<code>dl = ldiv(-123456, 1000);</code>

uldiv

Prototype	<code>uldiv_t uldiv(unsigned long number, unsigned long denom);</code>
Description	<p>Function is similar to the div function, except that the arguments and result structure members all have type <code>unsigned long</code>.</p> <p>Function computes the result of division of the numerator <code>number</code> by the denominator <code>denom</code>; the function returns a structure of type <code>uldiv_t</code> comprising quotient (<code>quot</code>) and remainder (<code>rem</code>), see Div Structures.</p>
Example	<code>dul = uldiv(123456,1000);</code>

labs

Prototype	<code>long labs(long x);</code>
Description	Function returns the absolute (i.e. positive) value of long integer <code>x</code> .
Example	<code>result = labs(-2147483647);</code>

max

Prototype	<code>int max(int a, int b);</code>
Description	Function returns greater of the two integers, <code>a</code> and <code>b</code> .
Example	<code>result = max(123,67); // function returns 123</code>

min

Prototype	<code>int min(int a, int b);</code>
Description	Function returns lower of the two integers, <code>a</code> and <code>b</code> .
Example	<code>result = min(123,67); // function returns 67</code>

rand

Prototype	<code>int rand();</code>
Description	Function returns a sequence of pseudo-random numbers between 0 and 32767. The function will always produce the same sequence of numbers unless <code>srand</code> is called to seed the start point.
Example	<pre>while(1) result = rand() ;</pre>

srand

Prototype	<code>void srand(unsigned x);</code>
Description	Function uses <code>x</code> as a starting point for a new sequence of pseudo-random numbers to be returned by subsequent calls to <code>rand</code> . No values are returned by this function.
Example	<code>srand(9);</code>

xtoi

Prototype	<code>unsigned xtoi(char *s);</code>
Description	Function converts the input string <code>s</code> consisting of hexadecimal digits into an integer value. The input parameter <code>s</code> should consist exclusively of hexadecimal digits, with an optional whitespace and a sign at the beginning. The string will be processed one character at a time, until the function reaches a character which it doesn't recognize (including a null character).
Example	<code>result = xtoi("1FF"); // result = 511</code>

Div Structures

Copy Code To Clipboard

```
typedef struct divstruct {
    int quot;
    int rem;
} div_t;

typedef struct ldivstruct {
    long quot;
    long rem;
} ldiv_t;

typedef struct uldivstruct {
    unsigned long quot;
    unsigned long rem;
} uldiv_t;
```

ANSI C String Library

The mikroC PRO for dsPIC30/33 and PIC24 provides a set of standard ANSI C library functions useful for manipulating strings and RAM memory.

Important:

- Not all of the standard functions have been included.
- The functions have been mostly implemented according to the ANSI C standard, but certain functions have been modified in order to facilitate dsPIC30/33 and PIC24 programming. Be sure to skim through the description before using standard C functions.

Library Functions

- memchr
- memcmp
- memcpy
- memmove
- memset
- strcat
- strchr
- strcmp
- strcpy
- strlen
- strncat
- strncpy
- strspn
- strncmp
- strstr
- strcspn
- strpbrk
- strrchr
- strtok

memchr

Prototype	<code>void *memchr(void *p, char n, unsigned int v);</code>
Description	<p>Function locates the first occurrence of char <code>n</code> in the initial <code>v</code> bytes of memory area starting at the address <code>p</code>. The function returns the pointer to this location or <code>0</code> if the <code>n</code> was not found.</p> <p>For parameter <code>p</code> you can use either a numerical value (literal/variable/constant) indicating memory address or a dereferenced value of an object, for example <code>&mystring</code> or <code>&PORTB</code>.</p>
Example	<pre>char txt[] = "mikroElektronika"; res = memchr(txt, 'e', 16); // example locates first occurrence of the letter 'e' in the string 'txt' in the first 16 characters of the string</pre>

memcmp

Prototype	<code>int memcmp(void *s1, void *s2, int n);</code>
Description	Function compares the first <code>n</code> characters of objects pointed to by <code>s1</code> and <code>s2</code> and returns zero if the objects are equal, or returns a difference between the first differing characters (in a left-to-right evaluation). Accordingly, the result is greater than zero if the object pointed to by <code>s1</code> is greater than the object pointed to by <code>s2</code> and vice versa.
Example	<pre>char txt[] = "mikroElektronika"; char txt_sub[] = "mikro; res = memcmp(txt, txt_sub, 16); // returns 69, which is ASCII code of the first differing character - letter 'E'</pre>

memcpy

Prototype	<code>void *memcpy(void *d1, void *s1, int n);</code>
Description	Function copies <code>n</code> characters from the object pointed to by <code>s1</code> into the object pointed to by <code>d1</code> . If copying takes place between objects that overlap, the behavior is undefined. The function returns address of the object pointed to by <code>d1</code> .
Example	<pre>char txt[] = "mikroElektronika"; char txt_sub[] = "mikr; res = memcpy(txt+4, txt_sub, 4); // string 'txt' will be populated with the first 4 characters of the 'txt_sub' string, beginning from the 4th character // routine returns the address of the first populated character, if memory areas of the strings don't overlap</pre>

memmove

Prototype	<code>void *memmove(void *to, void *from, int n);</code>
Description	Function copies <code>n</code> characters from the object pointed to by <code>from</code> into the object pointed to by <code>to</code> . Unlike <code>memcpy</code> , the memory areas <code>to</code> and <code>from</code> may overlap. The function returns address of the object pointed to by <code>to</code> .
Example	<pre>char txt[] = "mikroElektronika"; char txt_sub[] = "mikr; res = memmove(txt+7, txt_sub, 4); // string 'txt' will be populated with first 4 characters of the 'txt_sub' string, beginning from the 7th character // routine returns the address of the first populated character (memory areas of the object may overlap)</pre>

memset

Prototype	<code>void *memset(void *p1, char character, int n);</code>
Description	Function copies the value of the <code>character</code> into each of the first <code>n</code> characters of the object pointed by <code>p1</code> . The function returns address of the object pointed to by <code>p1</code> .
Example	<pre>char txt[] = "mikroElektronika"; memset(txt, 'a', 2); // routine will copy the character 'a' into each of the first 'n' characters of the string 'txt',</pre>

strcat

Prototype	<code>char *strcat(char *to, char *from);</code>
Description	Function appends a copy of the string <code>from</code> to the string <code>to</code> , overwriting the null character at the end of <code>to</code> . Then, a terminating null character is added to the result. If copying takes place between objects that overlap, the behavior is undefined. <code>to</code> string must have enough space to store the result. The function returns address of the object pointed to by <code>to</code> .
Example	<pre>char txt[] = "mikroElektronika"; char *res; txt[3] = 0; res = strcat(txt, "_test"); // routine will append the '_test' at the place of the first null character, adding terminating null character to the result // routine returns the address of the 'txt' string</pre>

strchr

Prototype	<code>char *strchr(char *ptr, char chr);</code>
Description	Function locates the first occurrence of character <code>chr</code> in the string <code>ptr</code> . The function returns a pointer to the first occurrence of character <code>chr</code> , or a null pointer if <code>chr</code> does not occur in <code>ptr</code> . The terminating null character is considered to be a part of the string.
Example	<pre>char txt[] = "mikroElektronika"; char *res; res = strchr(txt, 'E'); // routine will locate the character 'E' in the 'txt' string, and return the address of the character</pre>

strcmp

Prototype	<code>int strcmp(char *s1, char *s2);</code>
Description	Function compares strings <code>s1</code> and <code>s2</code> and returns zero if the strings are equal, or returns a difference between the first differing characters (in a left-to-right evaluation). Accordingly, the result is greater than zero if <code>s1</code> is greater than <code>s2</code> and vice versa.
Example	<pre>char txt = "mikroElektronika"; char txt_sub = "mikro"; int res; res = strcmp(txt,txt_sub); // compares strings 'txt' and 'txt_sub' and returns returns a difference between the first differing characters, in this case 69</pre>

strcpy

Prototype	<code>char *strcpy(char *to, char *from);</code>
Description	Function copies the string <code>from</code> into the string <code>to</code> . If copying is successful, the function returns <code>to</code> . If copying takes place between objects that overlap, the behavior is undefined.
Example	<pre>char txt = "mikroElektronika"; char txt_sub = "mikro_test"; int res; res = strcpy(txt,txt_sub); // copies string 'txt_sub' to 'txt'</pre>

strlen

Prototype	<code>int strlen(char *s);</code>
Description	Function returns the length of the string <code>s</code> (the terminating null character does not count against string's length).
Example	<pre>char txt = "mikroElektronika"; int result; result = strlen(txt); // calculates the length of the 'txt' string, result = 16</pre>

strncat

Prototype	<code>char *strncat(char *to, char *from, int size);</code>
Description	Function appends not more than <code>size</code> characters from the string <code>from</code> to <code>to</code> . The initial character of <code>from</code> overwrites the null character at the end of <code>to</code> . The terminating null character is always appended to the result. The function returns <code>to</code> .
Example	<pre>char txt = "mikroElektronika"; char txt_sub = "mikro"; char *result; txt[5] = 0; result = strncat(txt,txt_sub,4); // routine appends first 4 characters from the string 'txt_sub' at the place of first null character in the 'txt' string</pre>

strncpy

Prototype	<code>char *strncpy(char *to, char *from, int size);</code>
Description	Function copies not more than <code>size</code> characters from string <code>from</code> to <code>to</code> . If copying takes place between objects that overlap, the behavior is undefined. If <code>from</code> is shorter than <code>size</code> characters, then <code>to</code> will be padded out with null characters to make up the difference. The function returns the resulting string <code>to</code> .
Example	<pre>char txt = "mikroElektronika"; char txt_sub = "mikro_test"; int res; res = strncpy(txt,txt_sub,4); // copies first 4 characters form the string 'txt_sub' to 'txt'</pre>

strspn

Prototype	<code>int strspn(char *str1, char *str2);</code>
Description	Function returns the length of the maximum initial segment of <code>str1</code> which consists entirely of characters from <code>str2</code> . The terminating null character at the end of the string is not compared.
Example	<pre>char txt = "mikroElektronika"; char txt_sub = "mikro_test"; int res; result = strspn(txt,txt_sub); // routne returns 4</pre>

strncmp

Prototype	<code>int strncmp(char *s1, char *s2, char len);</code>								
Description	<p>Function lexicographically compares not more than <code>len</code> characters (characters that follow the null character are not compared) from the string pointed by <code>s1</code> to the string pointed by <code>s2</code>. The function returns a value indicating the <code>s1</code> and <code>s2</code> relationship:</p> <table border="0"> <tr> <td>Value</td> <td>Meaning</td> </tr> <tr> <td>< 0</td> <td>s1 "less than" s2</td> </tr> <tr> <td>= 0</td> <td>s1 "equal to" s2</td> </tr> <tr> <td>> 0</td> <td>s1 "greater than" s2</td> </tr> </table>	Value	Meaning	< 0	s1 "less than" s2	= 0	s1 "equal to" s2	> 0	s1 "greater than" s2
Value	Meaning								
< 0	s1 "less than" s2								
= 0	s1 "equal to" s2								
> 0	s1 "greater than" s2								
Example	<pre>char txt = "mikroElektronika"; char txt_sub = "mikro"; int res; res = strncmp(txt_sub,txt,3); // compares the first 3 characters from the string 'txt' with the sting 'txt_sub' and returns a difference</pre>								

strstr

Prototype	<code>char *strstr(char *s1, char *s2);</code>
Description	<p>Function locates the first occurrence of the string <code>s2</code> in the string <code>s1</code> (excluding the terminating null character).</p> <p>The function returns pointer to first occurrence of <code>s2</code> in <code>s1</code>; if no string was found, function returns 0. If <code>s2</code> is a null string, the function returns 0.</p>
Example	<pre>char txt = "mikroElektronika"; char txt_sub = "mikro"; char *res; res = strstr(txt_sub,txt);</pre>

strcspn

Prototype	<code>char *strcspn(char * s1, char *s2);</code>
Description	Function computes the length of the maximum initial segment of the string pointed to by <code>s1</code> that consists entirely of characters that are not in the string pointed to by <code>s2</code> . The function returns the length of the initial segment.
Example	<pre>char txt = "mikroElektronika"; char txt_sub = "mikro"; char *res; res = strcspn(txt_sub,txt);</pre>

strpbrk

Prototype	<code>char *strpbrk(char * s1, char *s2);</code>
Description	Function searches <code>s1</code> for the first occurrence of any character from the string <code>s2</code> . The terminating null character is not included in the search. The function returns pointer to the matching character in <code>s1</code> . If <code>s1</code> contains no characters from <code>s2</code> , the function returns 0.
Example	<pre>char txt = "mikroElektronika"; char txt_sub = "mikro"; char *res; res = strpbrk(txt_sub,txt);</pre>

strrchr

Prototype	<code>char *strrchr(char * ptr, char chr);</code>
Description	Function searches the string <code>ptr</code> for the last occurrence of character <code>chr</code> . The null character terminating <code>ptr</code> is not included in the search. The function returns pointer to the last <code>chr</code> found in <code>ptr</code> ; if no matching character was found, function returns 0.
Example	<pre>char txt = "mikroElektronika"; res = strrchr(txt_sub,'k'); // returns the pointer to the 'k' character of the 'txt' string</pre>

strtok

Prototype	<code>char *strtok(char *s1, char *s2);</code>
Returns	The strtok function returns a pointer to the first character of a token, or a null pointer if there is no token.
Description	<p>A sequence of calls to the strtok function breaks the string pointed to by <code>s1</code> into a sequence of tokens, each of which is delimited by a character from the string pointed to by <code>s2</code>. The first call in the sequence has <code>s1</code> as its first argument, and is followed by calls with a null pointer as their first argument. The separator string pointed to by <code>s2</code> may be different from call to call.</p> <p>The first call in the sequence searches the string pointed to by <code>s1</code> for the first character that is not contained in the current separator string pointed to by <code>s2</code>. If no such character is found, then there are no tokens in the string pointed to by <code>s1</code> and the strtok function returns a null pointer. If such character is found, it is the start of the first token.</p> <p>The strtok function then searches from there for a character that is contained in the current separator string. If no such character is found, the current token extends to the end of the string pointed to by <code>s1</code>, and subsequent searches for a token will return a null pointer. If such a character is found, it is overwritten by a null character, which terminates the current token. The strtok function saves a pointer to the following character, from which the next search for a token will start.</p> <p>Each subsequent call, with a null pointer as the value of the first argument, starts searching from the saved pointer and behaves as described above.</p>
Example	<pre>char x[10] ; void main(){ strcpy(x, strtok("mikroE1", "Ek")); strcpy(x, strtok(0, "kE")); }</pre>

Miscellaneous Libraries

- Button Library
- Conversions Library
- PrintOut Library
- Setjmp Library
- Sprint Library
- Time Library
- Trigonometry Library

Button Library

The Button Library provides routines for detecting button presses and debouncing (eliminating the influence of contact flickering upon pressing a button).

Library Routines

- Button

strchr

Prototype	<code>unsigned int Button(unsigned int *port, unsigned int pin, unsigned int time, unsigned int active_state);</code>
Description	The function eliminates the influence of contact flickering upon pressing a button (debouncing). The Button pin is tested just after the function call and then again after the debouncing period has expired. If the pin was in the active state in both cases then the function returns 255 (true).
Parameters	<ul style="list-style-type: none"> - <code>port</code>: button port address - <code>pin</code>: button pin - <code>time</code>: debouncing period in milliseconds - <code>active_state</code>: determines what is considered as active state. Valid values: 0 (logical zero) and 1 (logical one)
Returns	<ul style="list-style-type: none"> - 255 if the pin was in the active state for given period. - 0 otherwise
Requires	Nothing.
Example	<pre>if (Button(&PORTD, 0, 1, 1)) PORTB = 0xFF; ...</pre>
Notes	None.

```
unsigned int oldstate;

void main() {
    ADPCFG = 0xFFFF;           // initialize AN pins as digital
    TRISD = 0xFFFF;           // initialize portd as input
    TRISB = 0x0000;           // initialize portb as output

    do {
        if (Button(&PORTD, 0, 1, 1))           // detect logical one state
            oldstate = 1;
        if (oldstate && Button(&PORTD, 0, 1, 0)) { // detect logical one to logical zero
transition
            LATB = ~LATB;                       // toggle portb
            oldstate = 0;
        }
    } while(1);
}
```

Conversions Library

The mikroC PRO for dsPIC30/33 and PIC24 Conversions Library provides routines for numerals to strings and BCD/decimal conversions.

Library Dependency Tree



Library Routines

You can get text representation of numerical value by passing it to one of the following routines:

- ByteToStr
- ShortToStr
- WordToStr
- IntToStr
- LongToStr
- LongWordToStr
- FloatToStr

- WordToStrWithZeros
- IntToStrWithZeros
- LongWordToStrWithZeros
- LongIntToStrWithZeros

- ByteToHex
- ShortToHex
- WordToHex
- IntToHex
- LongWordToHex
- LongIntToHex

- Rtrim
- Ltrim

The following functions convert decimal values to BCD and vice versa:

- Bcd2Dec
- Dec2Bcd
- Bcd2Dec16
- Dec2Bcd16

ByteToStr

Prototype	<code>void ByteToStr(unsigned short input, char *output);</code>
Description	Converts input byte to a string. The output string has fixed width of 4 characters including null character at the end (string termination). The output string is right justified and remaining positions on the left (if any) are filled with blanks.
Parameters	- <code>input</code> : byte to be converted - <code>output</code> : destination string
Returns	Nothing.
Requires	Destination string should be at least 4 characters in length.
Example	<pre>unsigned short t = 24; char txt[4]; ... ByteToStr(t, txt); // txt is " 24" (one blank here)</pre>
Notes	None.

ShortToStr

Prototype	<code>void ShortToStr(short input, char *output);</code>
Description	Converts input signed short number to a string. The output string has fixed width of 5 characters including null character at the end (string termination). The output string is right justified and remaining positions on the left (if any) are filled with blanks.
Parameters	- <code>input</code> : signed short number to be converted - <code>output</code> : destination string
Returns	Nothing.
Requires	Destination string should be at least 5 characters in length.
Example	<pre>short t = -24; char txt[5]; ... ShortToStr(t, txt); // txt is " -24" (one blank here)</pre>
Notes	None.

WordToStr

Prototype	<code>void WordToStr(unsigned input, char *output);</code>
Description	Converts input word to a string. The output string has fixed width of 6 characters including null character at the end (string termination). The output string is right justified and the remaining positions on the left (if any) are filled with blanks.
Parameters	<ul style="list-style-type: none"> - <code>input</code>: word to be converted - <code>output</code>: destination string
Returns	Nothing.
Requires	Destination string should be at least 6 characters in length.
Example	<pre>unsigned t = 437; char txt[6]; ... WordToStr(t, txt); // txt is " 437" (two blanks here)</pre>
Notes	None.

IntToStr

Prototype	<code>void IntToStr(int input, char *output);</code>
Description	Converts input signed integer number to a string. The output string has fixed width of 7 characters including null character at the end (string termination). The output string is right justified and the remaining positions on the left (if any) are filled with blanks.
Parameters	<ul style="list-style-type: none"> - <code>input</code>: signed integer number to be converted - <code>output</code>: destination string
Returns	Nothing.
Requires	Destination string should be at least 7 characters in length.
Example	<pre>int j = -4220; char txt[7]; ... IntToStr(j, txt); // txt is "-4220" (one blank here)</pre>
Notes	None.

LongToStr

Prototype	<code>void LongToStr(long input, char *output);</code>
Description	Converts input signed long integer number to a string. The output string has fixed width of 12 characters including null character at the end (string termination). The output string is right justified and the remaining positions on the left (if any) are filled with blanks.
Parameters	- <code>input</code> : signed long integer number to be converted - <code>output</code> : destination string
Returns	Nothing.
Requires	Destination string should be at least 12 characters in length.
Example	<pre>long jj = -3700000; char txt[12]; ... LongToStr(jj, txt); // txt is " -3700000" (three blanks here)</pre>
Notes	None.

LongWordToStr

Prototype	<code>void LongWordToStr(unsigned long input, char *output);</code>
Description	Converts input unsigned long integer number to a string. The output string has fixed width of 11 characters including null character at the end (string termination). The output string is right justified and the remaining positions on the left (if any) are filled with blanks.
Parameters	- <code>input</code> : unsigned long integer number to be converted - <code>output</code> : destination string
Returns	Nothing.
Requires	Destination string should be at least 11 characters in length.
Example	<pre>unsigned long jj = 3700000; char txt[11]; ... LongWordToStr(jj, txt); // txt is " 3700000" (three blanks here)</pre>
Notes	None.

FloatToStr

Prototype	<code>unsigned char FloatToStr(float fnum, unsigned char *str);</code>
Description	Converts a floating point number to a string. The output string is left justified and null terminated after the last digit.
Parameters	- <code>fnum</code> : floating point number to be converted - <code>str</code> : destination string
Returns	- 3 if input number is NaN - 2 if input number is -INF - 1 if input number is +INF - 0 if conversion was successful
Requires	Destination string should be at least 14 characters in length.
Example	<pre>float ff1 = -374.2; float ff2 = 123.456789; float ff3 = 0.000001234; char txt[15]; ... FloatToStr(ff1, txt); // txt is "-374.2" FloatToStr(ff2, txt); // txt is "123.4567" FloatToStr(ff3, txt); // txt is "1.234e-6"</pre>
Notes	Given floating point number will be truncated to 7 most significant digits before conversion.

WordToStrWithZeros

Prototype	<code>void WordToStrWithZeros(unsigned int input, char *output);</code>
Description	Converts input word to a string. The output string has fixed width of 6 characters including null character at the end (string termination). The output string is right justified and remaining positions on the left (if any) are filled with zeros.
Parameters	- <code>input</code> : unsigned integer to be converted - <code>output</code> : destination string
Returns	Nothing.
Requires	Destination string should be at least 6 characters in length.
Example	<pre>unsigned short t = 437; char txt[6]; ... WordToStrWithZeros(t, txt); // txt is "0437" (one zero here)</pre>
Notes	None.

IntToStrWithZeros

Prototype	<code>void IntToStrWithZeros(int input, char *output);</code>
Description	Converts input integer to a string. The output string has fixed width of 7 characters including null character at the end (string termination). The output string is right justified and remaining positions on the left (if any) are filled with zeros.
Parameters	- <code>input</code> : integer number to be converted - <code>output</code> : destination string
Returns	Nothing.
Requires	Destination string should be at least 7 characters in length.
Example	<pre>short t = -3276; char txt[7]; ... IntToStrWithZeros(t, txt); // txt is "-03276" (one zero here)</pre>
Notes	None.

LongWordToStrWithZeros

Prototype	<code>void LongWordToStrWithZeros(unsigned long input, char *output);</code>
Description	Converts input longword to a string. The output string has fixed width of 11 characters including null character at the end (string termination). The output string is right justified and the remaining positions on the left (if any) are filled with zeros.
Parameters	- <code>input</code> : unsigned long number to be converted - <code>output</code> : destination string
Returns	Nothing.
Requires	Destination string should be at least 11 characters in length.
Example	<pre>unsigned t = 12345678; char txt[11]; ... LongWordToStrWithZeros(t, txt); // txt is "0012345678" (two zeros)</pre>
Notes	None.

LongIntToStrWithZeros

Prototype	<code>void LongIntToStrWithZeros(long input, char *output);</code>
Description	Converts input signed long integer number to a string. The output string has fixed width of 12 characters including null character at the end (string termination). The output string is right justified and the remaining positions on the left (if any) are filled with zeros.
Parameters	- <code>input</code> : signed long number to be converted - <code>output</code> : destination string
Returns	Nothing.
Requires	Destination string should be at least 12 characters in length.
Example	<pre>int j = -12345678; char txt[12]; ... LongIntToStrWithZeros(j, txt); // txt is "-0012345678" (one zero here)</pre>
Notes	None.

ByteToHex

Prototype	<code>void ByteToHex(char input, char *output);</code>
Description	Converts input number to a string containing the number's hexadecimal representation. The output string has fixed width of 3 characters including null character at the end (string termination).
Parameters	- <code>input</code> : byte to be converted - <code>output</code> : destination string
Returns	Nothing.
Requires	Destination string should be at least 3 characters in length.
Example	<pre>unsigned short t = 2; char txt[3]; ... ByteToHex(t, txt); // txt is "02"</pre>
Notes	None.

ShortToHex

Prototype	<code>void ShortToHex(unsigned short input, char *output);</code>
Description	Converts input number to a string containing the number's hexadecimal representation. The output string has fixed width of 3 characters including null character at the end (string termination).
Parameters	- <code>input</code> : signed short number to be converted - <code>output</code> : destination string
Returns	Nothing.
Requires	Destination string should be at least 3 characters in length.
Example	<pre>short t = -100; char txt[3]; ... ShortToHex(t, txt); // txt is "9C"</pre>
Notes	None.

WordToHex

Prototype	<code>void WordToHex(unsigned input, char *output);</code>
Description	Converts input number to a string containing the number's hexadecimal representation. The output string has fixed width of 5 characters including null character at the end (string termination).
Parameters	<ul style="list-style-type: none"> - <code>input</code>: unsigned integer to be converted - <code>output</code>: destination string
Returns	Nothing.
Requires	Destination string should be at least 5 characters in length.
Example	<pre>unsigned t = 1111; char txt[5]; ... WordToHex(t, txt); // txt is "0457"</pre>
Notes	None.

IntToHex

Prototype	<code>void IntToHex(int input, char *output);</code>
Description	Converts input number to a string containing the number's hexadecimal representation. The output string has fixed width of 5 characters including null character at the end (string termination).
Parameters	<ul style="list-style-type: none"> - <code>input</code>: signed integer number to be converted - <code>output</code>: destination string
Returns	Nothing.
Requires	Destination string should be at least 5 characters in length.
Example	<pre>int j = -32768; char txt[5]; ... IntToHex(j, txt); // txt is "8000"</pre>
Notes	None.

LongWordToHex

Prototype	<code>void LongWordToHex(unsigned long input, char *output);</code>
Description	Converts input number to a string containing the number's hexadecimal representation. The output string has fixed width of 9 characters including null character at the end (string termination).
Parameters	- <code>input</code> : unsigned long integer number to be converted - <code>output</code> : destination string
Returns	Nothing.
Requires	Destination string should be at least 9 characters in length.
Example	<pre>unsigned long jj = 65535; char txt[9]; ... LongWordToHex(jj, txt); // txt is "0000FFFF"</pre>
Notes	None.

LongIntToHex

Prototype	<code>void LongIntToHex(long int input, char *output);</code>
Description	Converts input number to a string containing the number's hexadecimal representation. The output string has fixed width of 9 characters including null character at the end (string termination).
Parameters	- <code>input</code> : signed long integer number to be converted - <code>output</code> : destination string
Returns	Nothing.
Requires	Destination string should be at least 9 characters in length.
Example	<pre>long int jj = -2147483648; char txt[9]; ... LongIntToHex(jj, txt); // txt is "80000000"</pre>
Notes	None.

Dec2Bcd

Prototype	<code>unsigned short Dec2Bcd(unsigned short decnum);</code>
Description	Converts input unsigned short integer number to its appropriate BCD representation.
Parameters	- <code>decnum</code> : unsigned short integer number to be converted
Returns	Converted BCD value.
Requires	Nothing.
Example	<pre>unsigned short a, b; ... a = 22; b = Dec2Bcd(a); // b equals 34</pre>
Notes	None.

Bcd2Dec

Prototype	<code>unsigned short Bcd2Dec(unsigned short bcdnum);</code>
Description	Converts 8-bit BCD numeral to its decimal equivalent.
Parameters	- <code>bcdnum</code> : 8-bit BCD numeral to be converted
Returns	Converted decimal value.
Requires	Nothing.
Example	<pre>unsigned short a, b; ... a = 34; b = Bcd2Dec(22); // b equals 22</pre>
Notes	None.

Dec2Bcd16

Prototype	<code>unsigned Dec2Bcd16(unsigned decnum);</code>
Description	Converts unsigned 16-bit decimal value to its BCD equivalent.
Parameters	- <code>decnum</code> unsigned 16-bit decimal number to be converted
Returns	Converted BCD value.
Requires	Nothing.
Example	<pre> unsigned a, b; ... a = 2345; b = Dec2Bcd16(a); // b equals 9029 </pre>
Notes	None.

Bcd2Dec16

Prototype	<code>unsigned Bcd2Dec16(unsigned bcdnum);</code>
Description	Converts 16-bit BCD numeral to its decimal equivalent.
Parameters	- <code>bcdnum</code> 16-bit BCD numeral to be converted
Returns	Converted decimal value.
Requires	Nothing.
Example	<pre> unsigned a, b; ... a = 0x1234; // a equals 4660 b = Bcd2Dec16(a); // b equals 1234 </pre>
Notes	None.

Rtrim

Prototype	<code>char *Rtrim(char *string);</code>
Description	Trims the trailing spaces from array given with <code>*string</code>
Parameters	- <code>string</code> : array to be trimmed.
Returns	The function returns the address of the first non-space character.
Requires	Nothing.
Example	<pre>char *res; res = Rtrim(" mikroe"); // trims the trailing spaces and returns the address of the first non-space character</pre>
Notes	None.

Ltrim

Prototype	<code>char *Ltrim(char *string);</code>
Description	66 Trims the leading spaces from array given with <code>*string</code>
Parameters	- <code>string</code> : array to be trimmed.
Returns	The function returns the address of the first non-space character.
Requires	Nothing.
Example	<pre>char *res; res = Ltrim(" mikroe"); // trims the leading spaces and returns the address of the first non-space character</pre>
Notes	None.

PrintOut Library

The mikroC PRO for dsPIC30/33 and PIC24 provides the PrintOut routine for easy data formatting and printing.

Library Dependency Tree



Library Routines

-PrintOut

PrintOut

Prototype	<code>void PrintOut(void (*prntoutfunc)(char ch), const char *f,...);</code>
Description	<code>PrintOut</code> is used to format data and print them in a way defined by the user through a print handler function.
Parameters	<p>- <code>prntoutfunc</code>: print handler function - <code>f</code>: format string</p> <p>The <code>f</code> argument is a format string and may be composed of characters, escape sequences, and format specifications. Ordinary characters and escape sequences are copied to the print handler in order in which they are interpreted. Format specifications always begin with a percent sign (%) and require additional arguments to be included in the function call.</p> <p>The format string is read from left to right. The first format specification encountered refers to the first argument after the <code>f</code> parameter and then converts and outputs it using the format specification. The second format specification accesses the second argument after <code>f</code>, and so on. If there are more arguments than format specifications, the extra arguments are ignored. Results are unpredictable if there are not enough arguments for the format specifications. The format specifications have the following format:</p> <pre>% [flags] [width] [.precision] [{ l L }] conversion_type</pre> <p>Each field in the format specification can be a single character or a number which specifies a particular format option. The <code>conversion_type</code> field is where a single character specifies that an argument is interpreted as a character, string, number, or pointer, as shown in the following table:</p>

Parameters	<i>conversion_type</i>	Argument Type	Output Format
	d	int	Signed decimal number
	u	unsigned int	Unsigned decimal number
	o	unsigned int	Unsigned octal number
	x	unsigned int	Unsigned hexadecimal number using 0123456789abcdef
	X	unsigned int	Unsigned hexadecimal number using 0123456789ABCDEF
	f	double	Floating-point number using the format [-]dddd.dddd
	e	double	Floating-point number using the format [-]d.dddde[-]dd
	E	double	Floating-point number using the format [-]d.ddddE[-]dd
	g	double	Floating-point number using either e or f format, whichever is more compact for the specified value and precision
	c	int	int is converted to an unsigned char, and the resulting character is written
	s	char *	String with a terminating null character
	p	void *	Pointer value, the X format is used
	%	<none>	A % is written. No argument is converted. The complete conversion specification shall be %%.

The *flags* field is where a single character is used to justify the output and to print +/- signs and blanks, decimal points, and octal and hexadecimal prefixes, as shown in the following table.

<i>flags</i>	Meaning
-	Left justify the output in the specified field width.
+	Prefix the output value with + or - sign if the output is a signed type.
space (' ')	Prefix the output value with a blank if it is a signed positive value. Otherwise, no blank is prefixed.
#	Prefix a non-zero output value with 0, 0x, or 0X when used with o, x, and X field types, respectively. When used with the e, E, f, g, and G field types, the # flag forces the output value to include a decimal point. In any other case the # flag is ignored.
*	Ignore format specifier.

The *width* field is a non-negative number that specifies a minimum number of printed characters. If a number of characters in the output value is less than width, blanks are added on the left or right (when the - flag is specified) in order to pad to the minimum width. If the width is prefixed with 0, then zeros are padded instead of blanks. The *width* field never truncates a field. If the length of the output value exceeds the specified width, all characters are output.

Parameters	<p>The <code>precision</code> field is a non-negative number that specifies the number of characters to print, number of significant digits, or number of decimal places. The precision field can cause truncation or rounding of the output value in the case of a floating-point number as specified in the following table.</p> <table border="1" data-bbox="275 232 1329 736"> <thead> <tr> <th data-bbox="275 232 484 269"><i>flags</i></th> <th data-bbox="484 232 1329 269">Meaning of the <i>precision</i> field</th> </tr> </thead> <tbody> <tr> <td data-bbox="275 269 484 428"><code>d, u, o, x, X</code></td> <td data-bbox="484 269 1329 428">The precision field is where you specify the minimum number of digits that will be included in the output value. Digits are not truncated if the number of digits in an argument exceeds that defined in the precision field. If the number of digits in the argument is less than the precision field, the output value is padded on the left with zeros.</td> </tr> <tr> <td data-bbox="275 428 484 497"><code>f</code></td> <td data-bbox="484 428 1329 497">The precision field is where you specify the number of digits to the right of the decimal point. The last digit is rounded.</td> </tr> <tr> <td data-bbox="275 497 484 565"><code>e, E</code></td> <td data-bbox="484 497 1329 565">The precision field is where you specify the number of digits to the right of the decimal point. The last digit is rounded.</td> </tr> <tr> <td data-bbox="275 565 484 633"><code>g</code></td> <td data-bbox="484 565 1329 633">The precision field is where you specify the maximum number of significant digits in the output value.</td> </tr> <tr> <td data-bbox="275 633 484 671"><code>c, C</code></td> <td data-bbox="484 633 1329 671">The precision field has no effect on these field types.</td> </tr> <tr> <td data-bbox="275 671 484 736"><code>s</code></td> <td data-bbox="484 671 1329 736">The precision field is where you specify the maximum number of characters in the output value. Excess characters are not output.</td> </tr> </tbody> </table> <p>The optional characters <code>l</code> or <code>L</code> may immediately precede <code>conversion_type</code> to respectively specify long versions of the integer types <code>d</code>, <code>i</code>, <code>u</code>, <code>o</code>, <code>x</code>, and <code>X</code>.</p> <p>You must ensure that the argument type matches that of the format specification. You can use type casts to ensure that the proper type is passed to <code>printout</code>.</p>	<i>flags</i>	Meaning of the <i>precision</i> field	<code>d, u, o, x, X</code>	The precision field is where you specify the minimum number of digits that will be included in the output value. Digits are not truncated if the number of digits in an argument exceeds that defined in the precision field. If the number of digits in the argument is less than the precision field, the output value is padded on the left with zeros.	<code>f</code>	The precision field is where you specify the number of digits to the right of the decimal point. The last digit is rounded.	<code>e, E</code>	The precision field is where you specify the number of digits to the right of the decimal point. The last digit is rounded.	<code>g</code>	The precision field is where you specify the maximum number of significant digits in the output value.	<code>c, C</code>	The precision field has no effect on these field types.	<code>s</code>	The precision field is where you specify the maximum number of characters in the output value. Excess characters are not output.
<i>flags</i>	Meaning of the <i>precision</i> field														
<code>d, u, o, x, X</code>	The precision field is where you specify the minimum number of digits that will be included in the output value. Digits are not truncated if the number of digits in an argument exceeds that defined in the precision field. If the number of digits in the argument is less than the precision field, the output value is padded on the left with zeros.														
<code>f</code>	The precision field is where you specify the number of digits to the right of the decimal point. The last digit is rounded.														
<code>e, E</code>	The precision field is where you specify the number of digits to the right of the decimal point. The last digit is rounded.														
<code>g</code>	The precision field is where you specify the maximum number of significant digits in the output value.														
<code>c, C</code>	The precision field has no effect on these field types.														
<code>s</code>	The precision field is where you specify the maximum number of characters in the output value. Excess characters are not output.														
Returns	Nothing.														
Requires	Nothing.														
Example	Print mikroElektronika example's header file to UART. <pre data-bbox="275 1140 651 1397"> void PrintHandler(char c){ UART1_Write(c); } void main(){ UART1_Init(9600); Delay_ms(100); </pre>														

Example	<pre> PrintOut(PrintHandler, "/*\r\n" " * Project name:\r\n" " PrintOutExample (Sample usage of PrintOut() function)\r\n" " * Copyright:\r\n" " (c) MikroElektronika, 2006.\r\n" " * Revision History:\r\n" " 20060710:\r\n" " - Initial release\r\n" " * Description:\r\n" " Simple demonstration on usage of the PrintOut() function\r\n" " * Test configuration:\r\n" " MCU: PIC30F4013\r\n" " Dev.Board: EasydsPIC4A\r\n" " Oscillator: HS, %10.3fMHz\r\n" " Ext. Modules: None.\r\n" " SW: mikroC PRO for dsPIC30/33 and PIC24\r\n" " * NOTES:\r\n" " None.\r\n" " */\r\n", Get_Fosc_kHz()/1000.); } </pre>
Notes	None.

Setjmp Library

The Setjmp library contains functions and types definitions for bypassing the normal function call and return discipline.

`jmp_buf` is an array of unsigned int type suitable for holding information needed to restore a calling environment. Type declaration is contained in the `sejmp.h` header file which can be found in the `include` folder of the compiler.

Library Routines

- Setjmp
- Longjmp

Setjmp

Prototype	<code>int Setjmp(jmp_buf env);</code>
Description	This function saves calling position for a later use by Longjmp.
Parameters	- <code>env</code> : buffer suitable for holding information needed for restoring calling environment
Returns	- 0 if the return is from direct invocation - <code>nonzero value</code> if the return is from a call to Longjmp (this value will be set by the Longjmp routine)
Requires	Nothing.
Example	<pre>jmp_buf buf; ... Setjmp(buf);</pre>
Notes	None.

Longjmp

Prototype	<code>void Longjmp(jmp_buf env, int val);</code>
Description	Restores calling environment saved in <code>env</code> buffer by the most recent invocation of <code>Setjmp</code> . If there has been no such invocation, or the function containing the invocation of <code>Setjmp</code> has terminated in the interim, the behavior is undefined.
Parameters	<ul style="list-style-type: none"> - <code>env</code>: buffer holding the information saved by the corresponding <code>Setjmp</code> invocation - <code>val</code>: value to be returned by the corresponding <code>Setjmp</code> function
Returns	Nothing.
Requires	Invocation of <code>Longjmp</code> must occur before return from the function in which <code>Setjmp</code> was called encounters.
Example	<pre>jmp_buf buf; ... Longjmp(buf, 2);</pre>
Notes	None.

Library Example

This example demonstrates function cross calling using the `Setjmp` and `Longjmp` functions. When called, `Setjmp` saves its calling environment in its `jmp_buf` argument for a later use by `Longjmp`. `Longjmp`, on the other hand, restores the environment saved by the most recent invocation of `Setjmp` with the corresponding `jmp_buf` argument.

Copy Code To Clipboard

```

#include <Setjmp.h>

jmp_buf buf;           // Note: Program flow diagrams are indexed according
                       // to the sequence of execution

void func33(){         // 2<-----|
                       //          |
    Delay_ms(1000);   //          |
                       //          |
    asm nop;          //          |
    Longjmp(buf, 2);  // 3----->|
    asm nop;          //          |
}                       //          |
                       //          |
void func(){           // 1<-----|
                       //          |
    portb = 3;         //          |
    if (Setjmp(buf) == 2) // 3<-----|
        portb = 1;    // 4-->|
    else                //          |
        func33();      // 2----->|
                       //          |
                       // 4<--|
}                       // 5----->|
                       //          |

void main() {         //          |
                       //          |
    PORTB = 0;         //          |
    TRISB = 0;         //          |
                       //          |
    asm nop;          //          |
                       //          |
    func();            // 1----->|
                       //          |
    asm nop;          // 5<-----|
    Delay_ms(1000);
    PORTB = 0xFFFF;
}

```

Sprint Library

The mikroC PRO for dsPIC30/33 and PIC24 provides the standard ANSI C `sprintf` function for easy data formatting.

Note: In addition to ANSI C standard, the Sprint Library also includes two limited versions of the `sprintf` function (`sprinti` and `sprintl`)

These functions take less ROM and RAM and may be more convenient for use in some cases.

Library Dependency Tree



Functions

- `sprintf`
- `sprintl`
- `sprinti`

sprintf

Prototype	<code>void sprintf(char *wh, const code char *f,...);</code>
Returns	The function returns the number of characters actually written to destination string.
Description	<p><code>sprintf</code> is used to format data and print them into destination string.</p> <p>Parameters:</p> <ul style="list-style-type: none"> - <code>wh</code>: destination string - <code>f</code>: format string <p>The <code>f</code> argument is a format string and may be composed of characters, escape sequences, and format specifications. Ordinary characters and escape sequences are copied to the destination string in the order in which they are interpreted. Format specifications always begin with a percent sign (<code>%</code>) and require additional arguments to be included in the function call.</p> <p>The format string is read from left to right. The first format specification encountered refers to the first argument after <code>f</code> and then converts and outputs it using the format specification. The second format specification accesses the second argument after <code>f</code>, and so on. If there are more arguments than format specifications, then these extra arguments are ignored. Results are unpredictable if there are not enough arguments for the format specifications. The format specifications have the following format:</p> <pre>% [flags] [width] [.precision] [{ l L }] conversion_type</pre> <p>Each field in the format specification can be a single character or a number which specifies a particular format option. The <code>conversion_type</code> field is where a single character specifies that the argument is interpreted as a character, string, number, or pointer, as shown in the following table:</p>

Description	<i>conversion_type</i>	Argument Type	Output Format
	d		<i>int</i>
u		<i>unsigned int</i>	Unsigned decimal number
o		<i>unsigned int</i>	Unsigned octal number
x		<i>unsigned int</i>	Unsigned hexadecimal number using 0123456789abcdef
X		<i>unsigned int</i>	Unsigned hexadecimal number using 0123456789ABCDEF
f		<i>double</i>	Floating-point number using the format [-]dddd.dddd
e		<i>double</i>	Floating-point number using the format [-]d.dddde[-]dd
E		<i>double</i>	Floating-point number using the format [-]d.ddddE[-]dd
g		<i>double</i>	Floating-point number using either e or f format, whichever is more compact for the specified value and precision
c		<i>int</i>	<i>int</i> is converted to an <i>unsigned char</i> , and the resulting character is written
s		<i>char *</i>	String with a terminating null character
p		<i>void *</i>	Pointer value, the X format is used
%		<none>	A % is written. No argument is converted. The complete conversion specification shall be %%.

The *flags* field is where a single character is used to justify the output and to print +/- signs and blanks, decimal points, and octal and hexadecimal prefixes, as shown in the following table.

<i>flags</i>	Meaning
-	Left justify the output in the specified field width.
+	Prefix the output value with + or - sign if the output is a signed type.
space (' ')	Prefix the output value with a blank if it is a signed positive value. Otherwise, no blank is prefixed.
#	Prefix a non-zero output value with 0, 0x, or 0X when used with o, x, and X field types, respectively. When used with the e, E, f, g, and G field types, the # flag forces the output value to include a decimal point. In any other case the # flag is ignored.
*	Ignore format specifier.

The *width* field is a non-negative number that specifies the minimum number of printed characters. If a number of characters in the output value is less than width, then blanks are added on the left or right (when the - flag is specified) to pad to the minimum width. If width is prefixed with 0, then zeros are padded instead of blanks. The width field never truncates a field. If a length of the output value exceeds the specified width, all characters are output.

Parameters	The <code>precision</code> field is a non-negative number that specifies a number of characters to print, number of significant digits or number of decimal places. The precision field can cause truncation or rounding of the output value in the case of a floating-point number as specified in the following table.	
	<i>flags</i>	Meaning of the <code>precision</code> field
	<code>d, u, o, x, X</code>	The precision field is where you specify the minimum number of digits that will be included in the output value. Digits are not truncated if the number of digits in an argument exceeds that defined in the precision field. If the number of digits in the argument is less than the precision field, the output value is padded on the left with zeros.
	<code>f</code>	The precision field is where you specify the number of digits to the right of the decimal point. The last digit is rounded.
	<code>e, E</code>	The precision field is where you specify the number of digits to the right of the decimal point. The last digit is rounded.
	<code>g</code>	The precision field is where you specify the maximum number of significant digits in the output value.
	<code>c, C</code>	The precision field has no effect on these field types.
	<code>s</code>	The precision field is where you specify the maximum number of characters in the output value. Excess characters are not output.
The optional characters <code>l</code> or <code>L</code> may immediately precede <code>conversion_type</code> to respectively specify long versions of the integer types <code>d, i, u, o, x, and X</code> .		
You must ensure that the argument type matches that of the format specification. You can use type casts to ensure that the proper type is passed to <code>sprintf</code> .		

sprintf

Prototype	<code>void sprintf(char *wh, const code char *f,...);</code>
Returns	The function returns the number of characters actually written to destination string.
Description	The same as <code>sprintf</code> , except it doesn't support float-type numbers.

sprintfi

Prototype	<code>void sprintfi(char *wh, const code char *f,...);</code>
Returns	The function returns the number of characters actually written to destination string.
Description	The same as <code>sprintf</code> , except it doesn't support long integers and float-type numbers.

Library Example

This is a demonstration of the standard C library sprintf routine usage. Three different representations of the same floating point number obtained by using the sprintf routine are sent via UART.

Copy Code To Clipboard

```
double ww = -1.2587538e+1;
char  buffer[15];

void main(){

    UART1_Init(4800);                // Initialize UART module at 4800 bps
    Delay_ms(10);

    UART1_Write_Text("Floating point number representation"); // Write message on UART

    sprintf(buffer, "%12e", ww);      // Format ww and store it to buffer
    UART1_Write_Text("rne format:"); // Write message on UART
    UART1_Write_Text(buffer);        // Write buffer on UART

    sprintf(buffer, "%12f", ww);      // Format ww and store it to buffer
    UART1_Write_Text("rnf format:"); // Write message on UART
    UART1_Write_Text(buffer);        // Write buffer on UART

    sprintf(buffer, "%12g", ww);      // Format ww and store it to buffer
    UART1_Write_Text("rng format:"); // Write message on UART
    UART1_Write_Text(buffer);        // Write buffer on UART
}
```

Time Library

The Time Library contains functions and type definitions for time calculations in the UNIX time format which counts the number of seconds since the “epoch”. This is very convenient for programs that work with time intervals: the difference between two UNIX time values is a real-time difference measured in seconds.

What is the epoch?

Originally it was defined as the beginning of 1970 GMT. (January 1, 1970 Julian day) GMT, Greenwich Mean Time, is a traditional term for the time zone in England.

The **TimeStruct** type is a structure type suitable for time and date storage. Type declaration is contained in `__Time.h` which can be found in the mikroC PRO for dsPIC30/33 and PIC24 Time Library Demo example folder.

Library Routines

- Time_dateToEpoch
- Time_epochToDate
- Time_dateDiff

Time_dateToEpoch

Prototype	<code>long Time_dateToEpoch(TimeStruct *ts);</code>
Description	This function returns the UNIX time : number of seconds since January 1, 1970 0h00mn00s.
Parameters	- <code>ts</code> : time and date value for calculating UNIX time.
Returns	Number of seconds since January 1, 1970 0h00mn00s.
Requires	Nothing.
Example	<pre>#include "__Time.h" ... TimeStruct ts1; long epoch ; ... //what is the epoch of the date in ts ? epoch = Time_dateToEpoch(&ts1) ;</pre>
Notes	None.

Time_epochToDate

Prototype	<code>void Time_epochToDate(long e, TimeStruct *ts);</code>
Description	Converts the UNIX time to time and date.
Parameters	<ul style="list-style-type: none"> - <code>e</code>: UNIX time (seconds since UNIX epoch) - <code>ts</code>: time and date structure for storing conversion output
Returns	Nothing.
Requires	Nothing.
Example	<pre>#include "__Time.h" ... TimeStruct ts2; long epoch ; ... //what date is epoch 1234567890 ? epoch = 1234567890 ; Time_epochToDate(epoch, &ts2) ;</pre>
Notes	None.

Time_dateDiff

Prototype	<code>long Time_dateDiff(TimeStruct *t1, TimeStruct *t2);</code>
Description	This function compares two dates and returns time difference in seconds as a signed long. Result is positive if <code>t1</code> is before <code>t2</code> , result is null if <code>t1</code> is the same as <code>t2</code> and result is negative if <code>t1</code> is after <code>t2</code> .
Parameters	<ul style="list-style-type: none"> - <code>t1</code>: time and date structure (the first comparison parameter) - <code>t2</code>: time and date structure (the second comparison parameter)
Parameters	None.
Returns	Time difference in seconds as a signed long.
Requires	Nothing.
Example	<pre>#include "__Time.h" ... TimeStruct ts1, ts2; long diff ; ... // how many seconds between these two dates contained in ts1 and ts2 // buffers? diff = Time_dateDiff(&ts1, &ts2) ;</pre>
Notes	None.

Library Example

Demonstration of Time library routines usage for time calculations in UNIX time format.

Copy Code To Clipboard

```
#include          "__Time.h"

TimeStruct ts1, ts2;
long epoch;
long diff;

void main() {

    ts1.ss = 0;
    ts1.mn = 7;
    ts1.hh = 17;
    ts1.md = 23;
    ts1.mo = 5;
    ts1.yy = 2006;

    /*
     * What is the epoch of the date in ts ?
     */
    epoch = Time_dateToEpoch(&ts1);          // 1148404020

    /*
     * What date is epoch 1234567890 ?
     */
    epoch = 1234567890;
    Time_epochToDate(epoch, &ts2);          // {0x1E, 0x1F,0x17, 0x0D, 0x04, 0x02, 0x07D9}

    /*
     * How much seconds between this two dates?
     */
    diff = Time_dateDiff(&ts1, &ts2);      // 86163870
}
```

Trigonometry Library

The mikroC PRO for dsPIC30/33 and PIC24 implements fundamental trigonometry functions. These functions are implemented as look-up tables. Trigonometry functions are implemented in integer format in order to save memory.

Library Routines

- sinE3
- cosE3

sinE3

Prototype	<code>int sinE3(unsigned angle_deg);</code>
Description	The function calculates sine multiplied by 1000 and rounded to the nearest integer: <code>result = round(sin(angle_deg)*1000)</code>
Parameters	- <code>angle_deg</code> : input angle in degrees
Returns	The function returns the sine of input parameter multiplied by 1000.
Requires	Nothing.
Example	<pre>int res; ... res = sinE3(45); // result is 707</pre>
Notes	Return value range: -1000..1000.

cosE3

Prototype	<code>int cosE3(unsigned angle_deg);</code>
Description	The function calculates cosine multiplied by 1000 and rounded to the nearest integer: <code>result = round(cos(angle_deg)*1000)</code>
Parameters	- <code>angle_deg</code> : input angle in degrees
Returns	The function returns the cosine of input parameter multiplied by 1000.
Requires	Nothing.
Example	<pre>int res; ... res = cosE3(196); // result is -193</pre>
Notes	Return value range: -1000..1000.

CHAPTER 10

Tutorials

Managing Project

Projects

The mikroC PRO for dsPIC30/33 and PIC24 organizes applications into *projects*, consisting of a single project file (extension `.mcpds`) and one or more source files (extension `.c`). mikroC PRO for dsPIC30/33 and PIC24 IDE allows you to manage multiple projects (see Project Manager). Source files can be compiled only if they are part of a project.

The project file contains the following information:

- project name and optional description,
- target device,
- device flags (config word),
- device clock,
- list of the project source files with paths,
- header files (*.h),
- binary files (*.mcl),
- image files,
- other files.

Note that the project does not include files in the same way as preprocessor does, see Add/Remove Files from Project.

New Project

The easiest way to create a project is by means of the New Project Wizard, drop-down menu **Project** > **New Project** or by clicking the New Project Icon  from Project Toolbar.

New Project Wizard Steps

Start creating your New project, by clicking Next button:

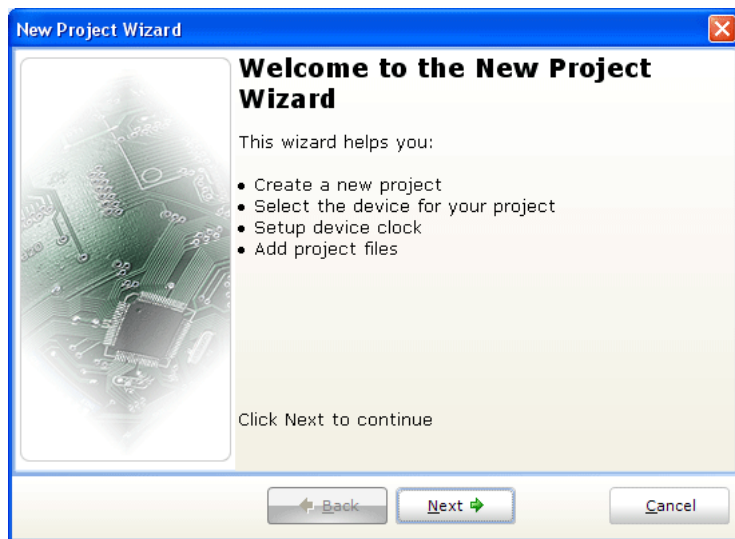

Step One - Select the device from the device drop-down list:

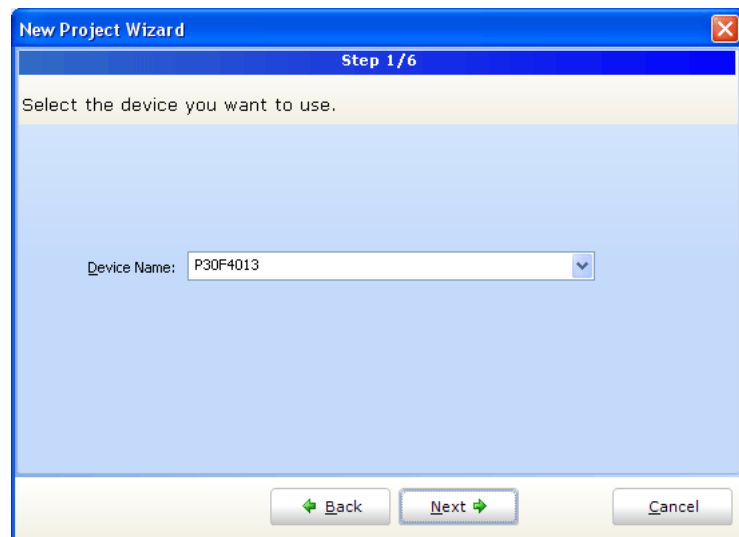

Step Two - Enter the oscillator frequency value:

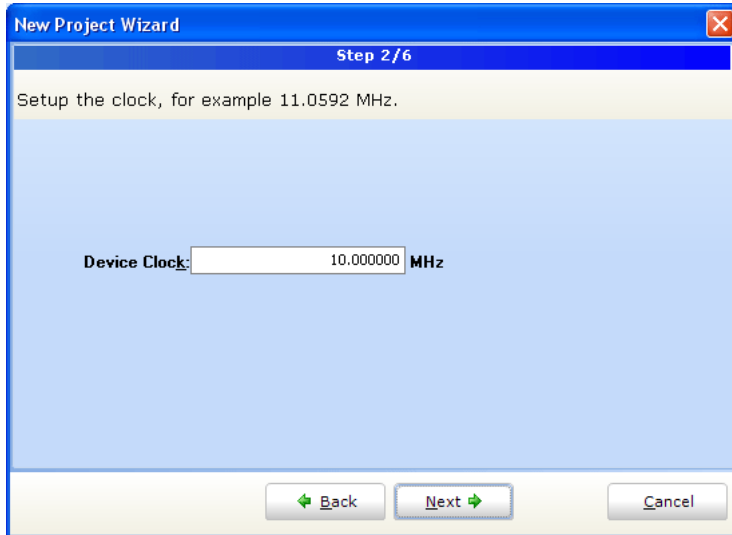

Step Three - Specify the location where your project will be saved:

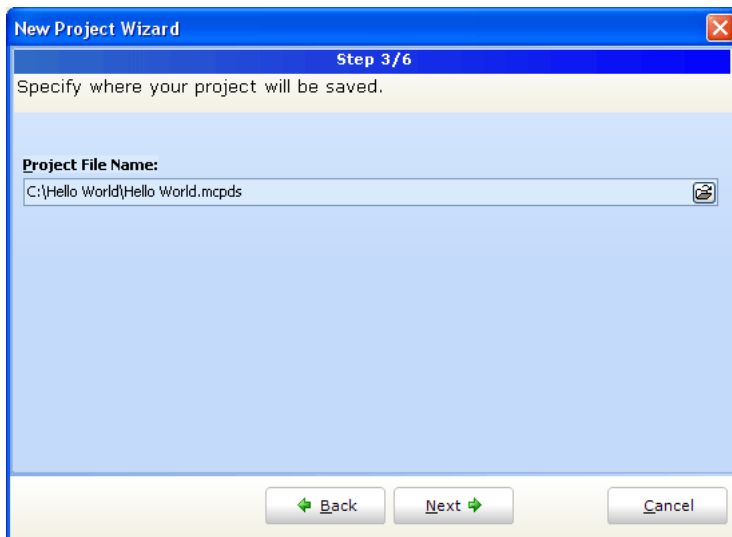

Step Four - Add project file to the project if they are available at this point. You can always add project files later using Project Manager:

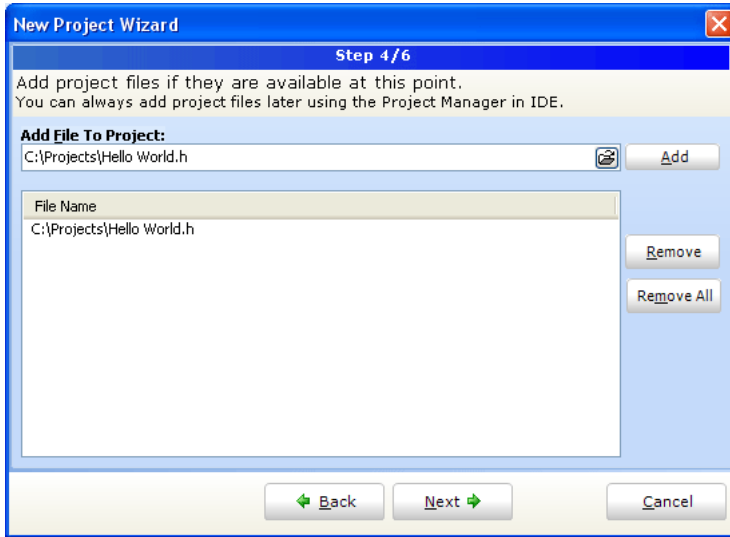

Step Five - Select initial Library Manager state:

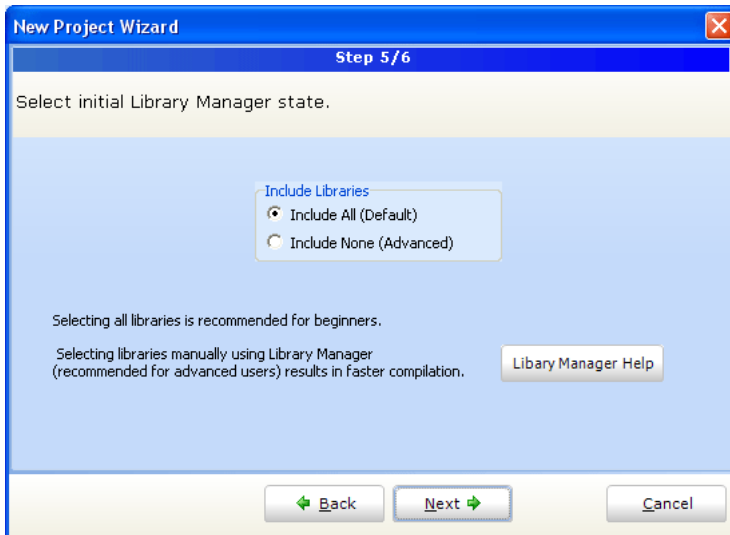

Step Six - Click Finish button to create your New Project:

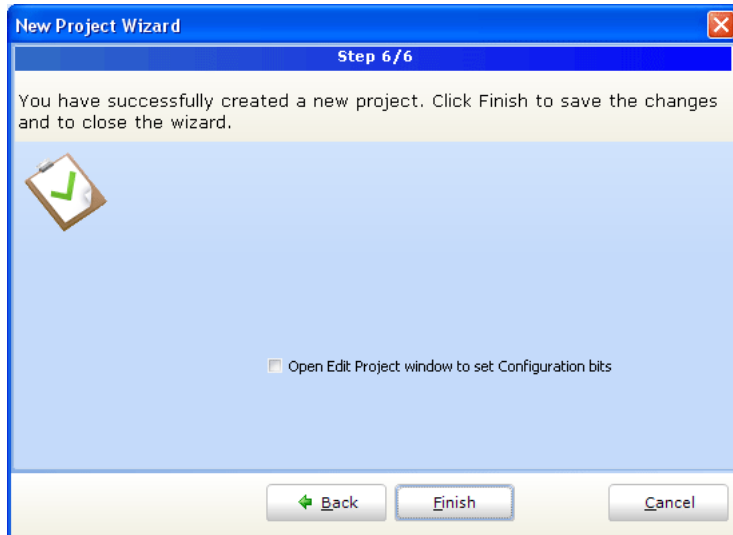

Related topics: Project Manager, Project Settings

New Project

The easiest way to create a project is by means of the New Project Wizard, drop-down menu Project › New Project or by clicking the New Project Icon  from Project Toolbar.

New Project Wizard Steps

Start creating your New project, by clicking Next button:



Step One - Select the device from the device drop-down list:



Step Two - Enter the oscillator frequency value:

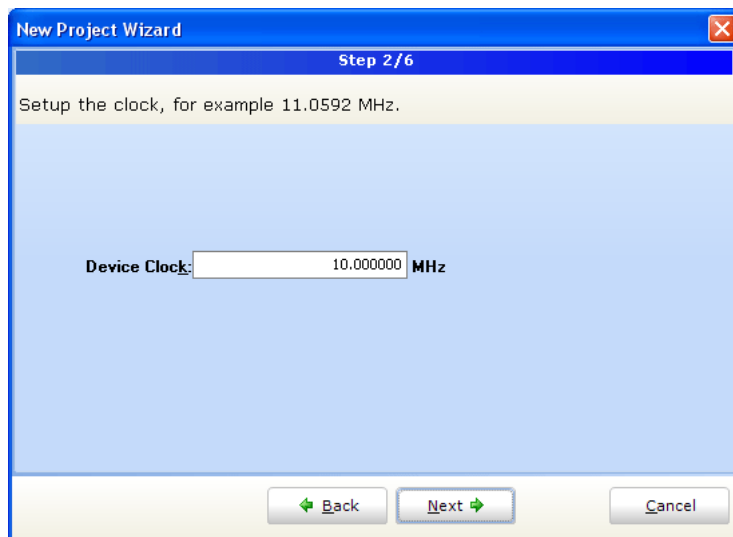

Step Three - Specify the location where your project will be saved:

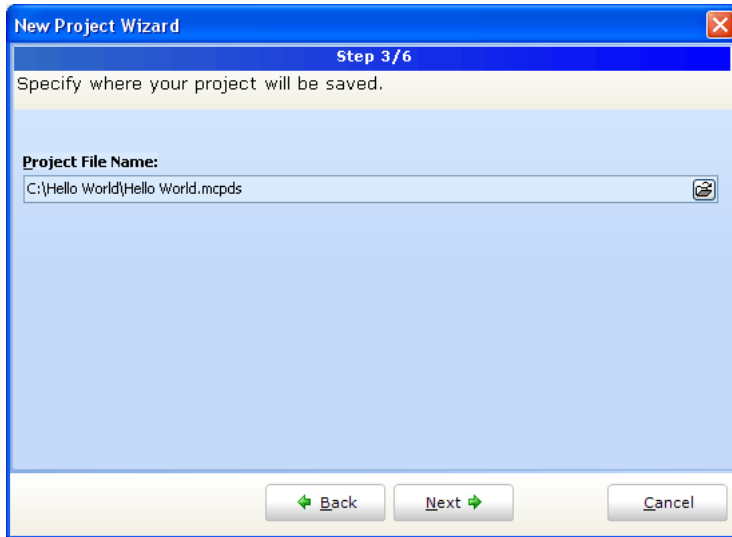

Step Four - Add project file to the project if they are available at this point. You can always add project files later using Project Manager:

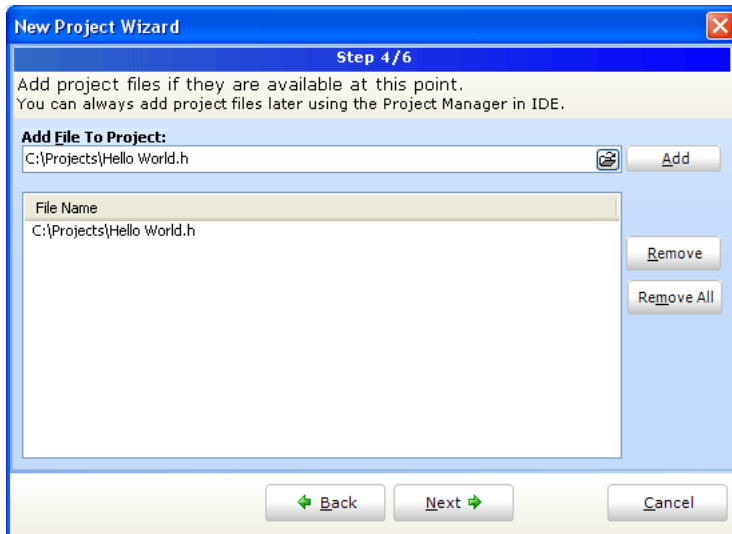

Step Five - Select initial Library Manager state:

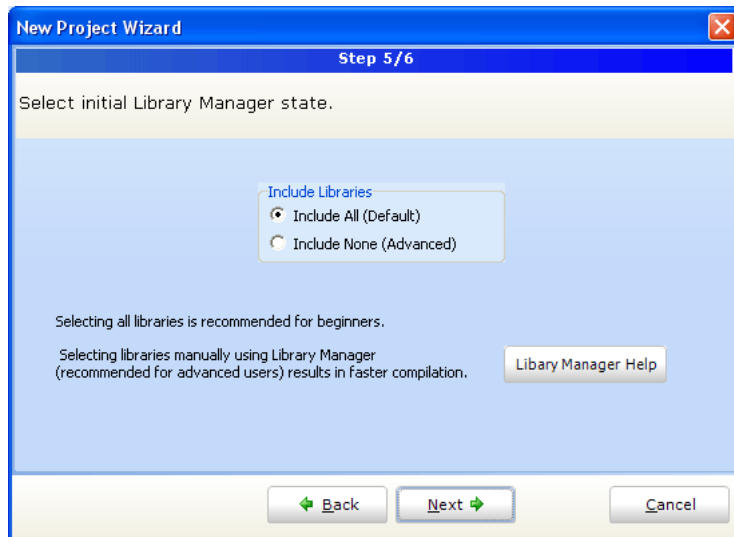

Step Six - Click Finish button to create your New Project:

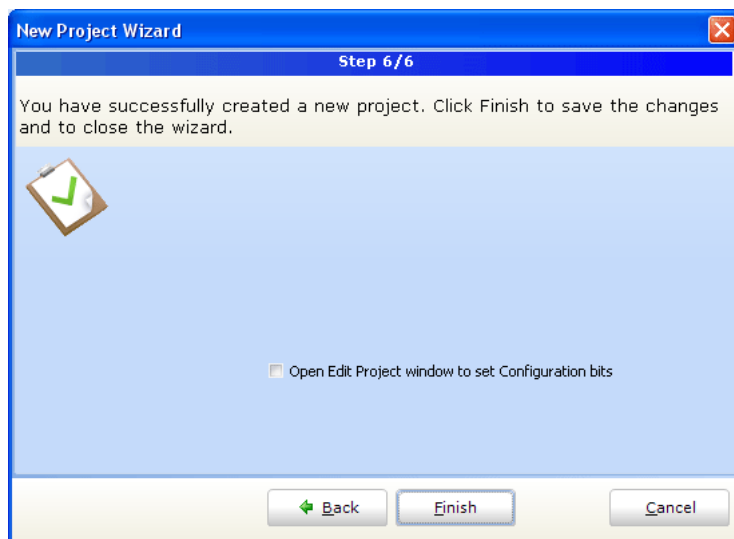

Related topics: Project Manager, Project Settings

Customizing Projects

You can change basic project settings in the Project Settings window. You can change chip, and oscillator frequency. Any change in the Project Setting Window affects currently active project only, so in case more than one project is open, you have to ensure that exactly the desired project is set as active one in the Project Manager. Also, you can change configuration bits of the selected chip in the Edit Project window.

Managing Project Group

mikroC PRO for dsPIC30/33 and PIC24 IDE provides convenient option which enables several projects to be open simultaneously. If you have several projects being connected in some way, you can create a project group.

The project group may be saved by clicking the Save Project Group Icon  from the Project Manager window.

The project group may be reopened by clicking the Open Project Group Icon . All relevant data about the project group is stored in the project group file (extension `.mcdsgroup`)

Add/Remove Files from Project

The project can contain the following file types:

- `.c` source files
- `.h` header files
- `.mcl` binary files
- `.pld` project level defines files
- image files
- `.ihex` EEPROM files
- `.hex`, `.asm` and `.lst` files, see output files. These files can not be added or removed from project.
- other files

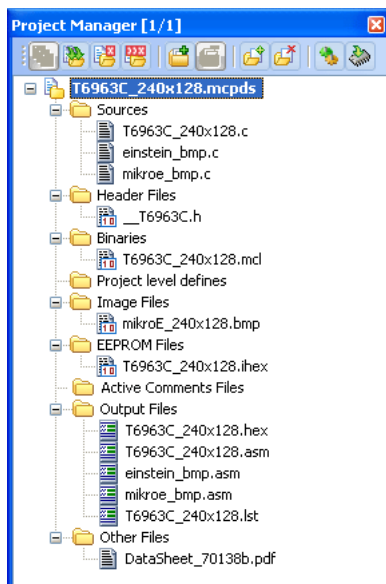

The list of relevant files is stored in the project file (extension `.mcpds`).

To add a file to the project, click the Add File to Project Icon  or press Insert button on your keyboard. Each added source file must be self-contained, i.e. it must have all necessary definitions after preprocessing.

To remove file(s) from the project, click the Remove File from Project Icon  or press Delete button on your keyboard.

Project Level Defines:

Project Level Defines (`.pld`) files can also be added to project. Project level define files enable you to have defines that are visible in all source files in the project. A file must contain one definition per line in the following form:

```
<symbol>=<value>
```

Define a macro named symbol. To specify a value, use `=<value>`. If `<value>` is omitted, 1 is assumed. Do not enter white-space characters immediately before the `"="`. If a white-space character is entered immediately after the `"="`, the macro is defined as zero token. This option can be specified repeatedly. Each appearance of symbol will be replaced by the value before compilation.

For example, lets make a project level define named `pld_test`. First of all, create a new file with the `.pld` extension, `pld_test_file.pld`.

Next, open it, and write something like this:

```
pld_test=3
```

Once you have done this, save the file. In the Project Manager, add `pld_test_file.pld` file by right-clicking the Project Level Defines node.

In the source code write the following:

```
#if pld_test == 3  
...  
#endif
```

There are number of predefined project level defines. See predefined project level defines

Note: For inclusion of the header files (extension `.h`), use the preprocessor directive `#include`. See File Inclusion for more information.

Related topics: Project Manager, Project Settings, Edit Project

Add/Remove Files from Project

The project can contain the following file types:

- .c source files
- .h header files
- .mcl binary files
- .pld project level defines files
- image files
- .ihex EEPROM files
- .hex, .asm and .lst files, see output files. These files can not be added or removed from project.
- other files

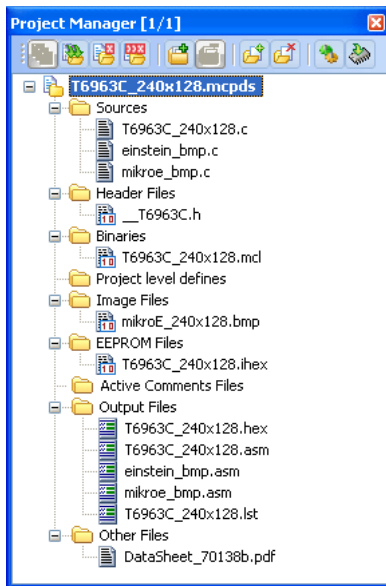

The list of relevant files is stored in the project file (extension `.mcpds`).

To add a file to the project, click the Add File to Project Icon  or press Insert button on your keyboard. Each added source file must be self-contained, i.e. it must have all necessary definitions after preprocessing.

To remove file(s) from the project, click the Remove File from Project Icon  or press Delete button on your keyboard.

Project Level Defines:

Project Level Defines (.pld) files can also be added to project. Project level define files enable you to have defines that are visible in all source files in the project. A file must contain one definition per line in the following form:

```
<symbol>=<value>
```

Define a macro named symbol. To specify a value, use =<value>. If =<value> is omitted, 1 is assumed. Do not enter white-space characters immediately before the “=”. If a white-space character is entered immediately after the “=”, the macro is defined as zero token. This option can be specified repeatedly. Each appearance of symbol will be replaced by the value before compilation.

For example, lets make a project level define named `pld_test`. First of all, create a new file with the .pld extension, `pld_test_file.pld`.

Next, open it, and write something like this:

```
pld_test=3
```

Once you have done this, save the file. In the Project Manager, add `pld_test_file.pld` file by right-clicking the Project Level Defines node.

In the source code write the following:

```
#if pld_test == 3  
...  
#endif
```

There are number of predefined project level defines. See predefined project level defines

Note: For inclusion of the header files (extension .h), use the preprocessor directive `#include`. See File Inclusion for more information.

Related topics: Project Manager, Project Settings, Edit Project

Source Files



Source files containing source code should have the extension `.c`. The list of source files relevant to the application is stored in project file with extension `.mcpds`, along with other project information. You can compile source files only if they are part of the project.

Use the preprocessor directive `#include` to include header files with the extension `.h`. Do not rely on the preprocessor to include source files other than headers — see Add/Remove Files from Project for more information.

Managing Source Files

Creating new source file

To create a new source file, do the following:

1. Select **File** › **New Unit** from the drop-down menu, or press Ctrl+N, or click the New File Icon  from the File Toolbar.
2. A new tab will be opened. This is a new source file. Select **File** › **Save** from the drop-down menu, or press Ctrl+S, or click the Save File Icon  from the File Toolbar and name it as you want.

If you use the New Project Wizard, an empty source file, named after the project with extension `.c`, will be created automatically. The mikroC PRO for dsPIC30/33 and PIC24 does not require you to have a source file named the same as the project, it's just a matter of convenience.

Opening an existing file

1. Select **File** › **Open** from the drop-down menu, or press Ctrl+O, or click the Open File Icon  from the File Toolbar. In Open Dialog browse to the location of the file that you want to open, select it and click the Open button.
2. The selected file is displayed in its own tab. If the selected file is already open, its current Editor tab will become active.

Printing an open file

1. Make sure that the window containing the file that you want to print is the active window.
2. Select **File** › **Print** from the drop-down menu, or press Ctrl+P.
3. In the Print Preview Window, set a desired layout of the document and click the OK button. The file will be printed on the selected printer.

Saving file

1. Make sure that the window containing the file that you want to save is the active window.
2. Select **File** › **Save** from the drop-down menu, or press Ctrl+S, or click the Save File Icon  from the File Toolbar.

Saving file under a different name

1. Make sure that the window containing the file that you want to save is the active window.
2. Select **File** > **Save As** from the drop-down menu. The New File Name dialog will be displayed.
3. In the dialog, browse to the folder where you want to save the file.
4. In the File Name field, modify the name of the file you want to save.
5. Click the Save button.

Closing file



1. Make sure that the tab containing the file that you want to close is the active tab.
2. Select **File** > **Close** from the drop-down menu, or right click the tab of the file that you want to close and select **Close** option from the context menu.
3. If the file has been changed since it was last saved, you will be prompted to save your changes.

Search Paths

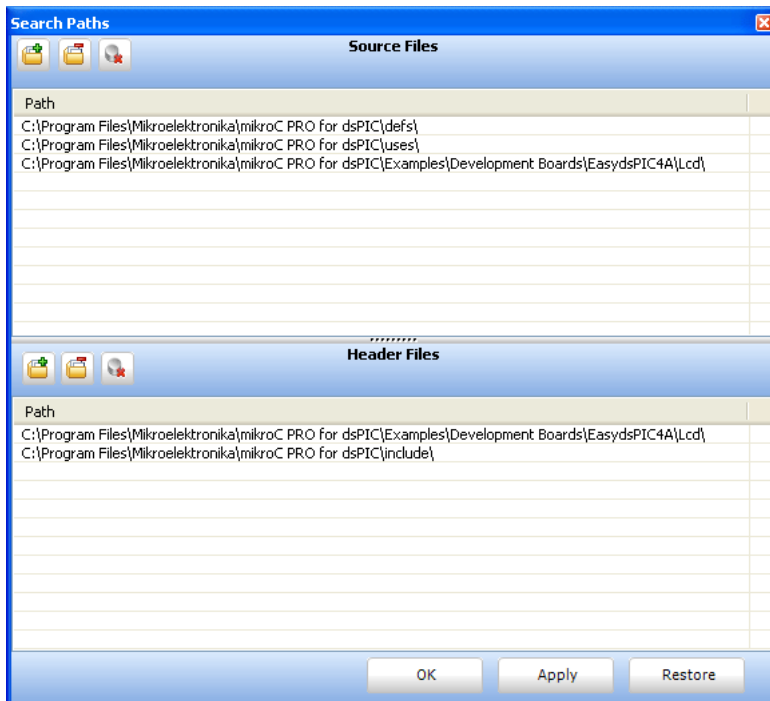
You can specify your own custom search paths: select **Project** > **Edit Search Paths...** option from the drop-down menu:



Following options are available:

Icon	Description
	Add Search Path.
	Remove Search Path.
	Purge Invalid Paths.

Paths for Source Files (.c)

You can specify either absolute or relative path to the source file. If you specify a relative path, mikroC PRO for dsPIC30/33 and PIC24 will look for the file in following locations, in this particular order:

1. the project folder (folder which contains the project file `.mcpds`),
2. your custom search paths,
3. mikroC PRO for dsPIC30/33 and PIC24 installation folder > `Uses` folder.

Paths for Header Files (.h)

Header files are included by means of preprocessor directive `#include`. If you place an explicit path to the header file in preprocessor directive, only that location will be searched.

You can specify either absolute or relative path to the header. If you specify a relative path, mikroC PRO for dsPIC30/33 and PIC24 will look for the file in following locations, in this particular order:

1. the project folder (folder which contains the project file `.h`),
2. mikroC PRO for dsPIC30/33 and PIC24 installation folder > `Include` folder.
3. your custom search paths

Related topics: File Menu, File Toolbar, Project Manager, Project Settings

Edit Project

Edit Project gives you option to change MCU you wish to use, change its oscillator frequency and build type. Also, Edit Project enables you to alter specific configuration bits of the selected device.

As you alter these bits, appropriate register values will be updated also. This can be viewed in the **Configuration Registers** pane.

When you have finished configuring your device, you can save bit configuration as a scheme, using **Load Scheme** button.

In case you need this scheme in another project, you can load it using **Save Scheme** button.

There is also a **Default** button which lets you select default configuration bit settings for the selected device.

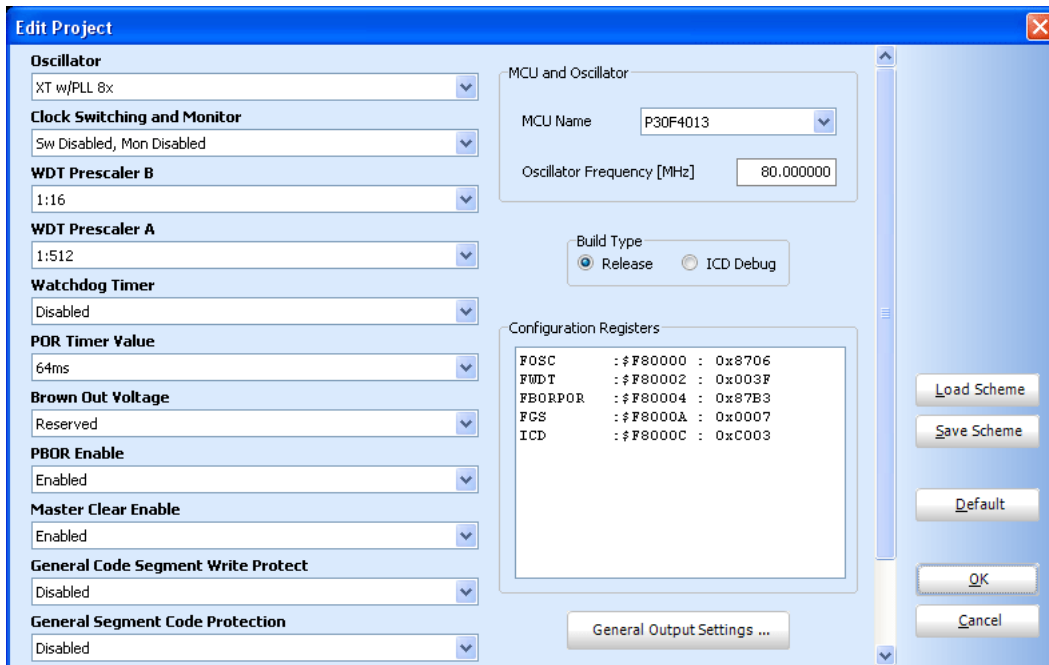

Related topics: Project Settings, Customizing Projects

Source Files



Source files containing source code should have the extension `.c`. The list of source files relevant to the application is stored in project file with extension `.mcpds`, along with other project information. You can compile source files only if they are part of the project.

Use the preprocessor directive `#include` to include header files with the extension `.h`. Do not rely on the preprocessor to include source files other than headers — see Add/Remove Files from Project for more information.

Managing Source Files

Creating new source file

To create a new source file, do the following:

1. Select **File** › **New Unit** from the drop-down menu, or press Ctrl+N, or click the New File Icon  from the File Toolbar.
2. A new tab will be opened. This is a new source file. Select **File** › **Save** from the drop-down menu, or press Ctrl+S, or click the Save File Icon  from the File Toolbar and name it as you want.

If you use the New Project Wizard, an empty source file, named after the project with extension `.c`, will be created automatically. The mikroC PRO for dsPIC30/33 and PIC24 does not require you to have a source file named the same as the project, it's just a matter of convenience.

Opening an existing file

1. Select **File** › **Open** from the drop-down menu, or press Ctrl+O, or click the Open File Icon  from the File Toolbar.
- In Open Dialog browse to the location of the file that you want to open, select it and click the Open button.
2. The selected file is displayed in its own tab. If the selected file is already open, its current Editor tab will become active.

Printing an open file

1. Make sure that the window containing the file that you want to print is the active window.
2. Select **File** › **Print** from the drop-down menu, or press Ctrl+P.
3. In the Print Preview Window, set a desired layout of the document and click the OK button. The file will be printed on the selected printer.

Saving file

1. Make sure that the window containing the file that you want to save is the active window.
2. Select **File** › **Save** from the drop-down menu, or press Ctrl+S, or click the Save File Icon  from the File Toolbar.

Saving file under a different name

1. Make sure that the window containing the file that you want to save is the active window.
2. Select **File** › **Save As** from the drop-down menu. The New File Name dialog will be displayed.
3. In the dialog, browse to the folder where you want to save the file.
4. In the File Name field, modify the name of the file you want to save.
5. Click the Save button.

Closing file



1. Make sure that the tab containing the file that you want to close is the active tab.
2. Select **File** › **Close** from the drop-down menu, or right click the tab of the file that you want to close and select **Close** option from the context menu.
3. If the file has been changed since it was last saved, you will be prompted to save your changes.

Search Paths

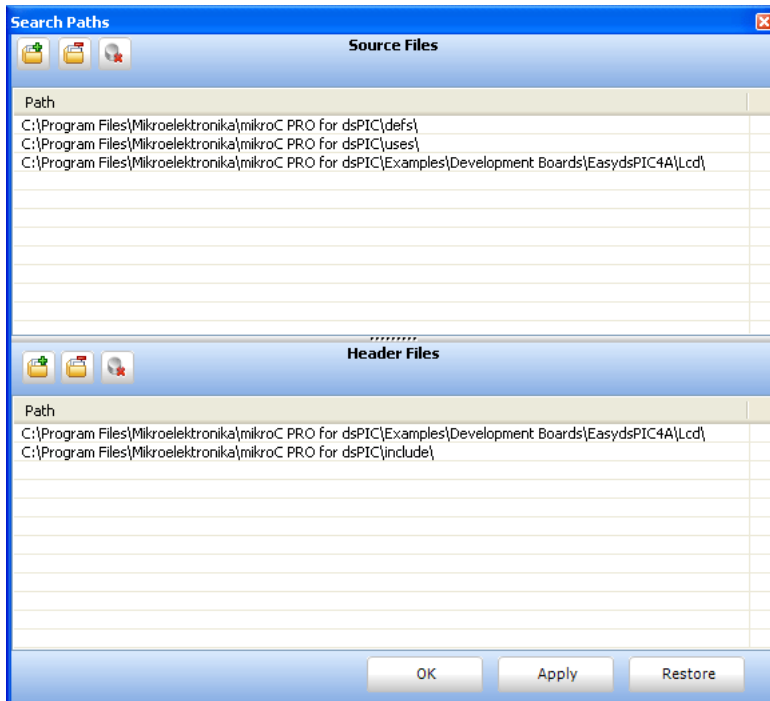
You can specify your own custom search paths: select **Project** › **Edit Search Paths...** option from the drop-down menu:



Following options are available:

Icon	Description
	Add Search Path.
	Remove Search Path.
	Purge Invalid Paths.

Paths for Source Files (.c)

You can specify either absolute or relative path to the source file. If you specify a relative path, mikroC PRO for dsPIC30/33 and PIC24 will look for the file in following locations, in this particular order:

1. the project folder (folder which contains the project file `.mcpds`),
2. your custom search paths,
3. mikroC PRO for dsPIC30/33 and PIC24 installation folder > `Uses` folder.

Paths for Header Files (.h)

Header files are included by means of preprocessor directive `#include`. If you place an explicit path to the header file in preprocessor directive, only that location will be searched.

You can specify either absolute or relative path to the header. If you specify a relative path, mikroC PRO for dsPIC30/33 and PIC24 will look for the file in following locations, in this particular order:

1. the project folder (folder which contains the project file `.h`),
2. mikroC PRO for dsPIC30/33 and PIC24 installation folder > `Include` folder.
3. your custom search paths

Related topics: File Menu, File Toolbar, Project Manager, Project Settings,

Clean Project Folder

This menu gives you option to choose which files from your current project you want to delete. Files marked in bold can be easily recreated by building a project. Other files should be marked for deletion only with a great care, because IDE cannot recover them.

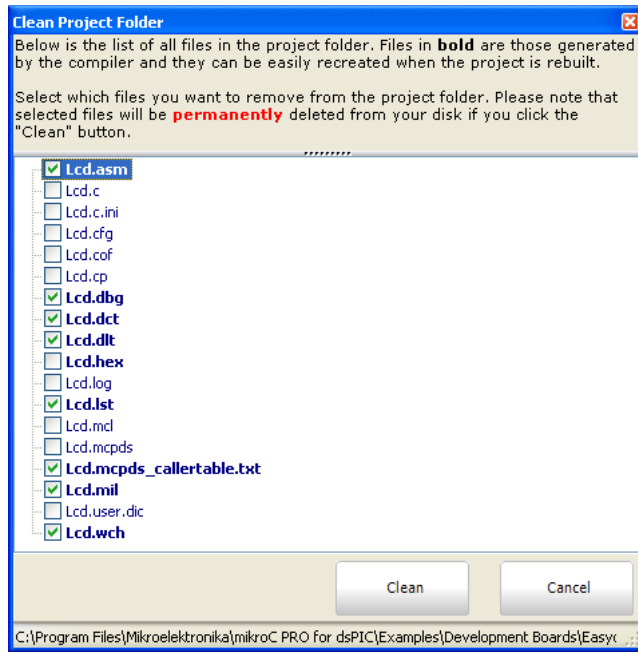

Related topics: Customizing Projects

Compilation

When you have created the project and written the source code, it's time to compile it. Select **Project** > **Build** from the drop-down menu, or click the Build Icon  from the Build Toolbar. If more more than one project is open you

can compile all open projects by selecting **Project** > **Build All Projects** from the drop-down menu, or click the Build All Projects Icon  from the Build Toolbar.

Progress bar will appear to inform you about the status of compiling. If there are some errors, you will be notified in the Messages Window. If no errors are encountered, the mikroC PRO for dsPIC30/33 and PIC24 will generate output files.

Output Files

Upon successful compilation, the mikroC PRO for dsPIC30/33 and PIC24 will generate output files in the project folder (folder which contains the project file `.mcpds`). Output files are summarized in the table below:

Format	Description	File Type
Intel HEX	Intel style hex records. Use this file to program MCU.	<code>.hex</code>
Binary	mikro Compiled Library. Binary distribution of application that can be included in other projects.	<code>.mcl</code>
List File	Overview of MCU memory allotment: instruction addresses, registers, routines and labels.	<code>.lst</code>
Assembler File	Human readable assembly with symbolic names, extracted from the List File.	<code>.asm</code>

Assembly View

After compiling the program in the mikroC PRO for dsPIC30/33 and PIC24, you can click the View Assembly icon 

or select **Project** > **View Assembly** from the drop-down menu to review the generated assembly code (`.asm` file) in a new tab window.

Assembly is human-readable with symbolic names.

Related topics: Project Menu, Project Toolbar, Messages Window, Project Manager, Project Settings

Creating New Library

mikroC PRO for dsPIC30/33 and PIC24 allows you to create your own libraries. In order to create a library in mikroC PRO for dsPIC30/33 and PIC24 follow the steps below:

1. Create a new source file, see Managing Source Files
2. Save the file in one of the subfolders of the compiler's Uses folder:
`DriveName:\Program Files\Mikroelektronika\mikroC PRO for dsPIC\Uses\`
3. Write a code for your library and save it.
4. Add `__Lib_Example` file in some project, see Project Manager. Recompile the project.
If you wish to use this library for all MCUs, then you should go to **Tools > Options > Output settings**, and check **Build all files as library** box.
This will build libraries in a common form which will work with all MCUs. If this box is not checked, then library will be built for selected MCU.
Bear in mind that compiler will report an error if a library built for specific MCU is used for another one.
5. Compiled file `__Lib_Example.mcl` should appear in `...\mikroC PRO for dsPIC\Uses\` folder.
6. Open the definition file for the MCU that you want to use. This file is placed in the compiler's Defs folder:
`DriveName:\Program Files\Mikroelektronika\mikroC PRO for dsPIC\Defs\`
and it is named `MCU_NAME.mlk`, for example `30F4013.mlk`
7. Add the the following segment of code to `<LIBRARIES>` node of the definition file (definition file is in XML format):

```
<LIB>
  <ALIAS>Example_Library</ALIAS>
  <FILE>__Lib_Example</FILE>
  <TYPE>REGULAR</TYPE>
</LIB>
```
8. Add Library to `mlk` file for each MCU that you want to use with your library.
9. Click Refresh button in Library Manager
10. `Example_Library` should appear in the Library manager window.

Multiple Library Versions

Library Alias represents unique name that is linked to corresponding Library `.mcl` file. For example UART library for 30F4013 is different from UART library for 30F6014 MCU. Therefore, two different UART Library versions were made, see `mlk` files for these two MCUs. Note that these two libraries have the same Library Alias (UART) in both `mlk` files. This approach enables you to have identical representation of UART library for both MCUs in Library Manager.

Related topics: Library Manager, Project Manager, Managing Source Files

Using Microchip MPLAB® IDE with mikroElektronika compilers

This new feature will boost your productivity by enabling you to import your code in a non-mikroElektronika environment - Microchip's MPLAB®.

With the introduction of COFF File in mikroElektronika compiler, it is possible to debug and analyze your code through a software or hardware simulator.

Debugging Your Code

If your program has been built correctly, the compiler should generate a `.hex` file and a `.cof` file. The `cof` file contains all the information necessary for high-level debugging in MPLAB®, and it should be loaded by selecting the **File > Import...** menu in the MPLAB®.

Once you have done this, you have two choices: either to use MPLAB® ICD 2 Debugger, if you have the appropriate hardware, or MPLAB® Simulator.

Trademarks:

The Microchip name and logo, the Microchip logo, Accuron, dsPIC, KEELOQ, KEELOQ logo, microID, MPLAB, PIC, PICmicro, PICSTART, PRO MATE, rPIC and SmartShunt are registered trademarks of Microchip Technology Incorporated in the U.S.A. and other countries.

Related topics: COFF File, Using MPLAB® ICD 2 Debugger, Using MPLAB® Simulator

Using MPLAB® ICD 2 Debugger

Important:

- It is assumed that MPLAB® and USB drivers for MPLAB® ICD 2 Debugger are previously installed.
- Procedure described below is also relevant for MPLAB® ICD 3 Debugger.
- Be sure to import compiled `.hex` file prior to importing `.cof` file, because it contains configuration bit settings which are essential for the proper functioning of the user code.

To successfully use MPLAB® ICD 2 Debugger with generated `.cof` file, follow the steps below:

1. First of all, start mikroC PRO for dsPIC30/33 and PIC24 and open the desired project. In this example, UART project for EasydsPIC4A board and dsPIC30F4013 will be opened.
2. Open **Tools > Options > Output settings**, and check the **“Generate COFF file”** option, and click the OK button.
3. After that, compile the project by pressing Ctrl + F9.
4. Connect USB cable and turn on power supply on EasydsPIC4A.
5. Program the MCU by pressing F11.
6. Connect external power supply, USB cable from PC and modular interface cable to the MPLAB® ICD 2 Debugger's appropriate sockets, like on the picture below :



7. Connect second end of the modular interface cable to the ICD (RJ12) socket of EasydsPIC4A :

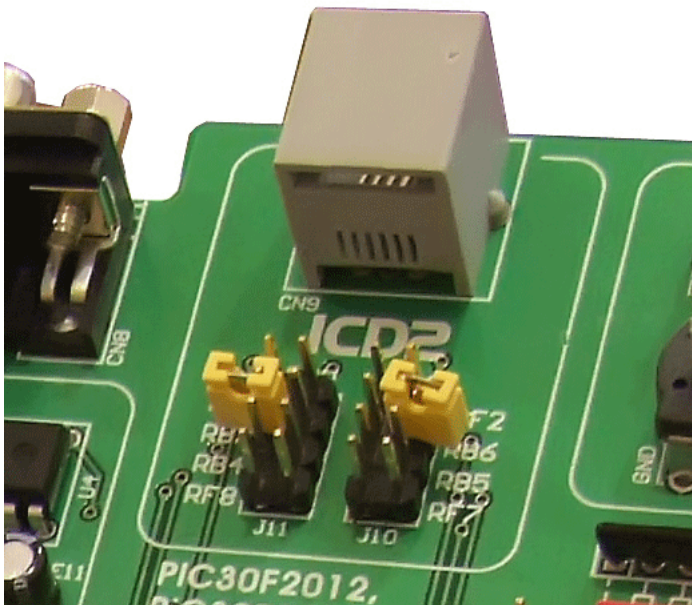

8. Put the J11 and J10 Jumpers in the correct position, as showed in the picture below:

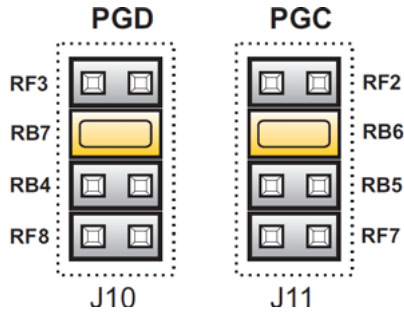

9. Next, open MPLAB®, and select the appropriate device by choosing **Configure > Select Device...** :

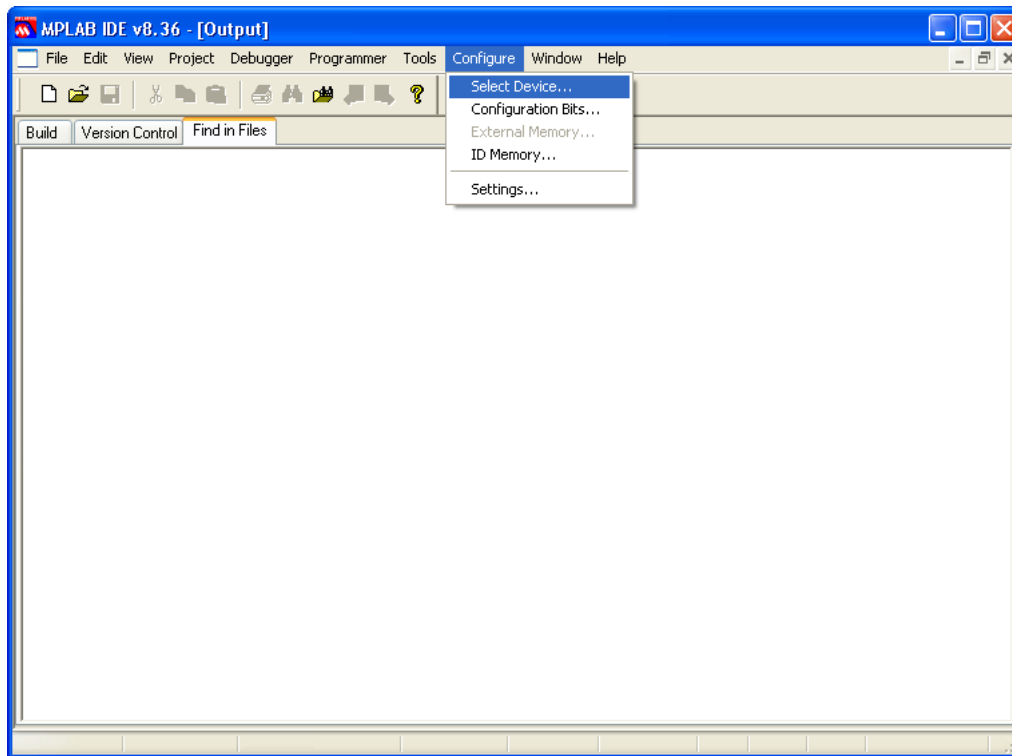

10. After device selection, click on the **File > Import**. Open file dialog box should appear. Then, go to the project folder and open the generated HEX file, `UART.hex`.

Note: This is very important, because hex file contains configuration bit settings which are essential for the proper functioning of the user code.

- Next, click the **File > Import**. Open file dialog box should appear. Then, go to the project folder and open the generated COFF file, `UART.cof`:

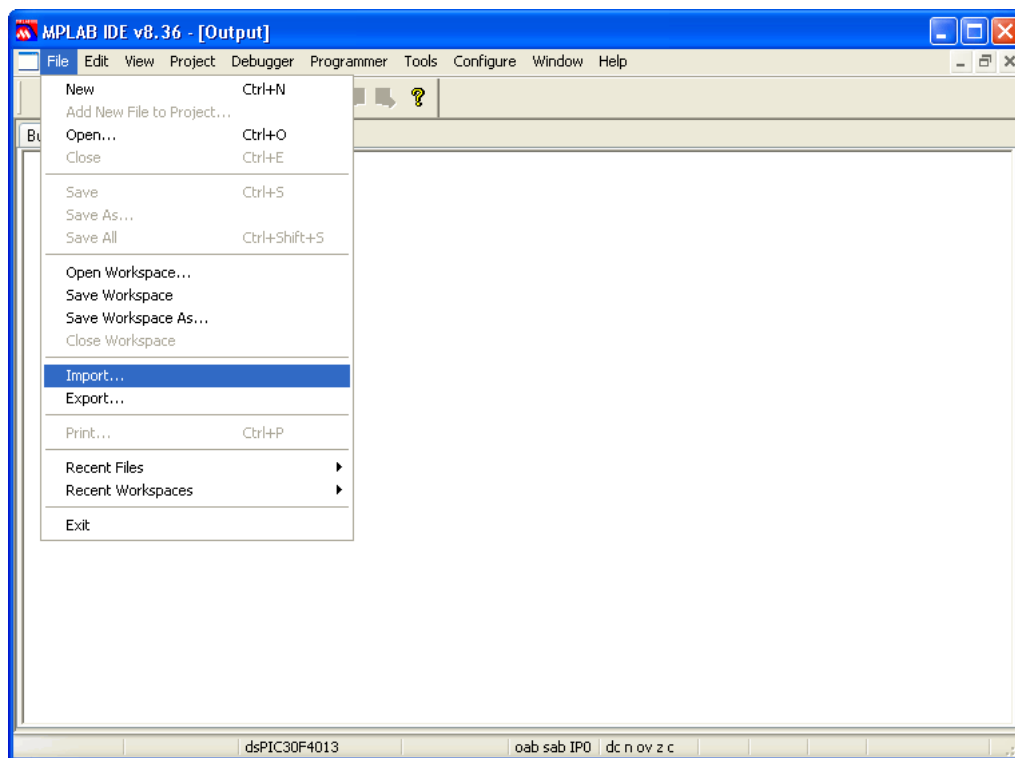

12. Then, select the **MPLAB® ICD 2** from the **Debugger > Select Tool** menu for hardware debugging:

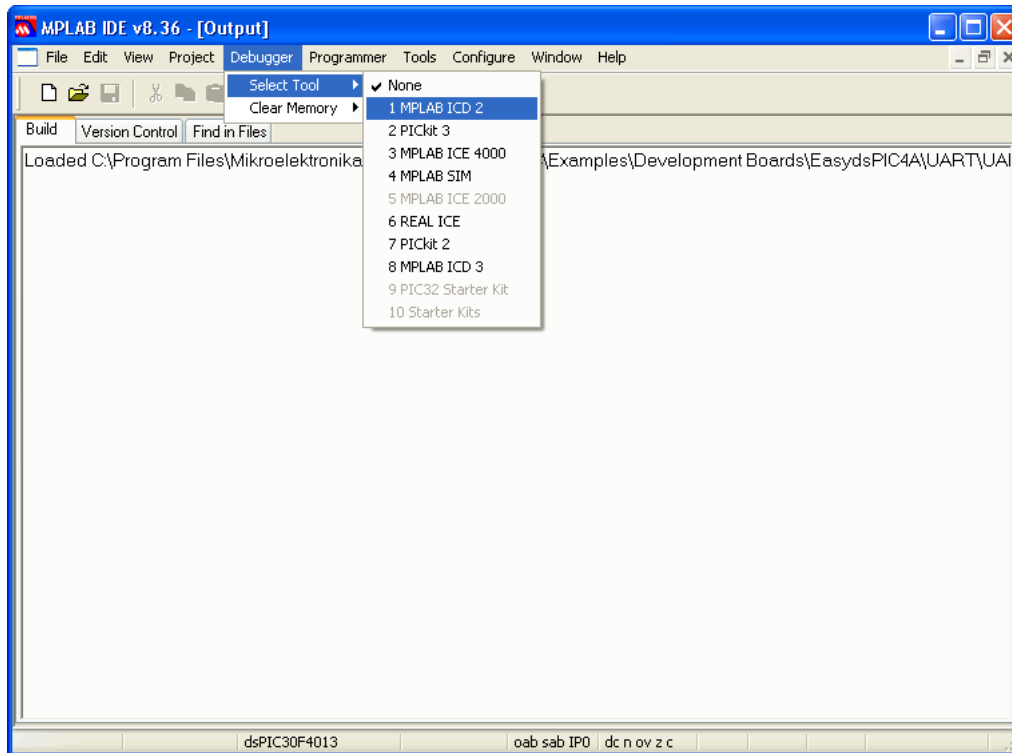

13. Complete the MPLAB® ICD 2 Setup Wizard from the **Debugger** menu (if needed).

14. After completing MPLAB® ICD 2 Setup Wizard, click on the **Debugger > Connect:**

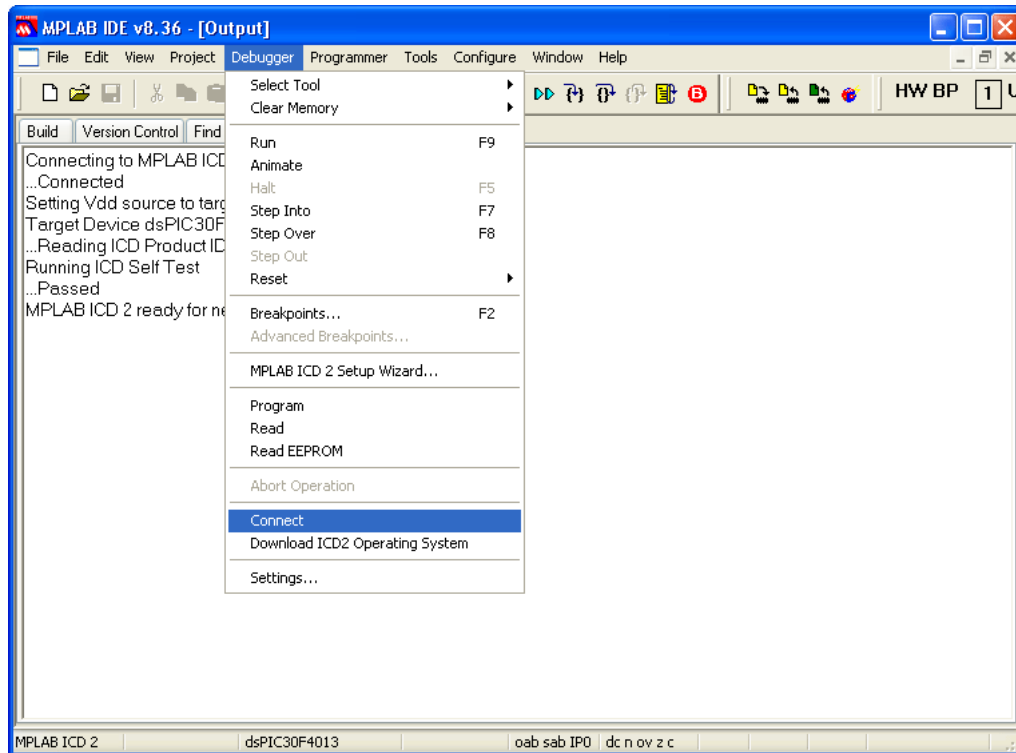

15. Finally, click on the **Debugger > Program**:

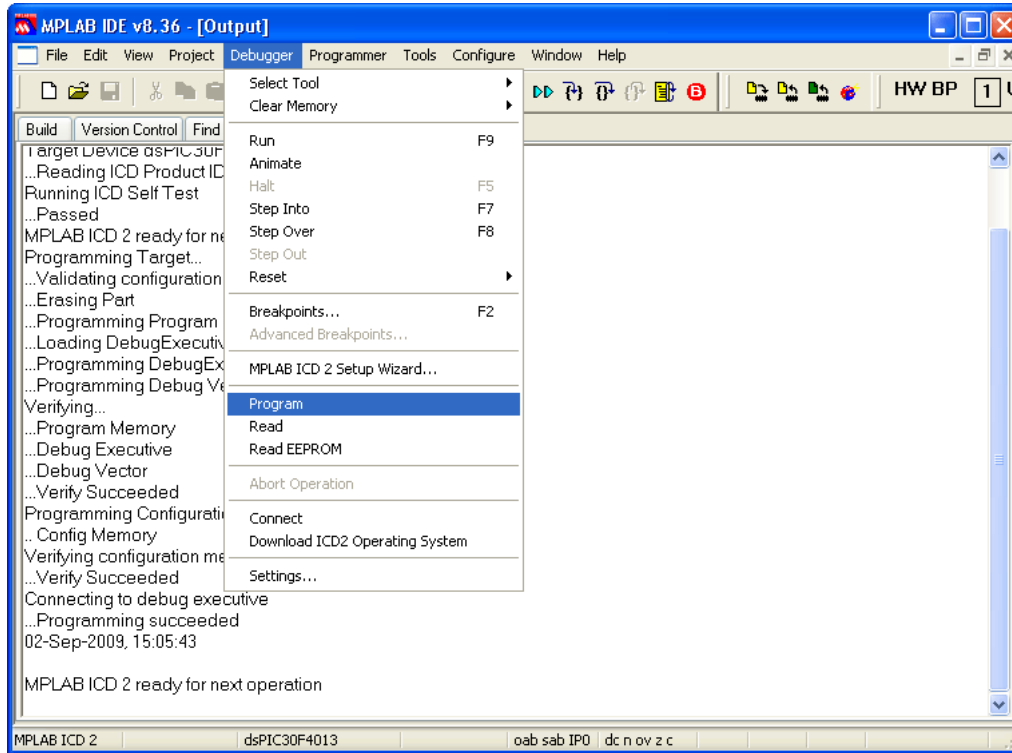

16. Now, you can start debugging the code by clicking Step Over button  on the Debug toolbar, or by pressing F8:

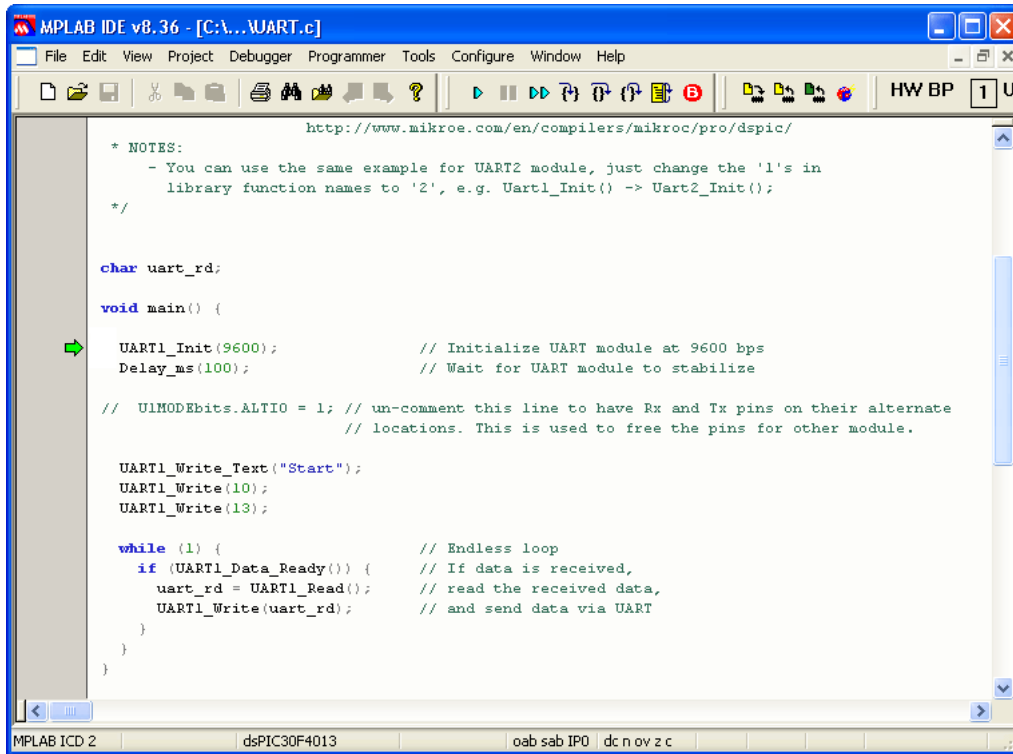

```
http://www.mikroe.com/en/compiler/mikroc/pro/dspic/

* NOTES:
- You can use the same example for UART2 module, just change the '1's in
  library function names to '2', e.g. Uart1_Init() -> Uart2_Init();
*/

char uart_rd;

void main() {
    UART1_Init(9600);           // Initialize UART module at 9600 bps
    Delay_ms(100);             // Wait for UART module to stabilize

    // U1MODEbits.ALTIO = 1; // un-comment this line to have Rx and Tx pins on their alternate
    // locations. This is used to free the pins for other module.

    UART1_Write_Text("Start");
    UART1_Write(10);
    UART1_Write(13);

    while (1) {                // Endless loop
        if (UART1_Data_Ready()) { // If data is received,
            uart_rd = UART1_Read(); // read the received data,
            UART1_Write(uart_rd);   // and send data via UART
        }
    }
}
```

Related topics: COFF File, Using MPLAB® Simulator

Using MPLAB® Simulator

Note: It is assumed that MPLAB® is previously installed.

1. First of all, start mikroC PRO for dsPIC30/33 and PIC24 Help and open the desired project. In this example, UART project for EasydsPIC4A board and dsPIC30F4013 will be opened.
2. Open **Tools > Options > Output settings**, and check the “**Generate COFF file**” option, and click the OK button.
3. After that, compile the project by pressing **Ctrl + F9**.
4. Next, open MPLAB®, and select the appropriate device by choosing **Configure > Select Device...** :

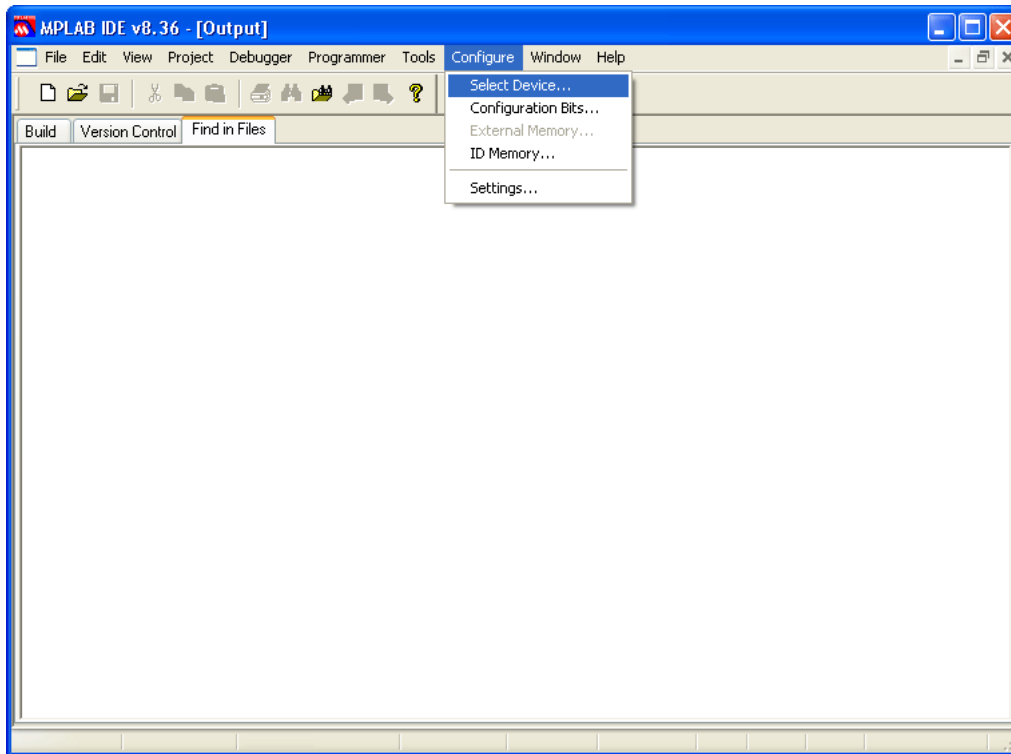

5. After device selection, click on the **File > Import**. Open file dialog box should appear. Then, go to the project folder and open the generated COFF file, `UART.cof` :

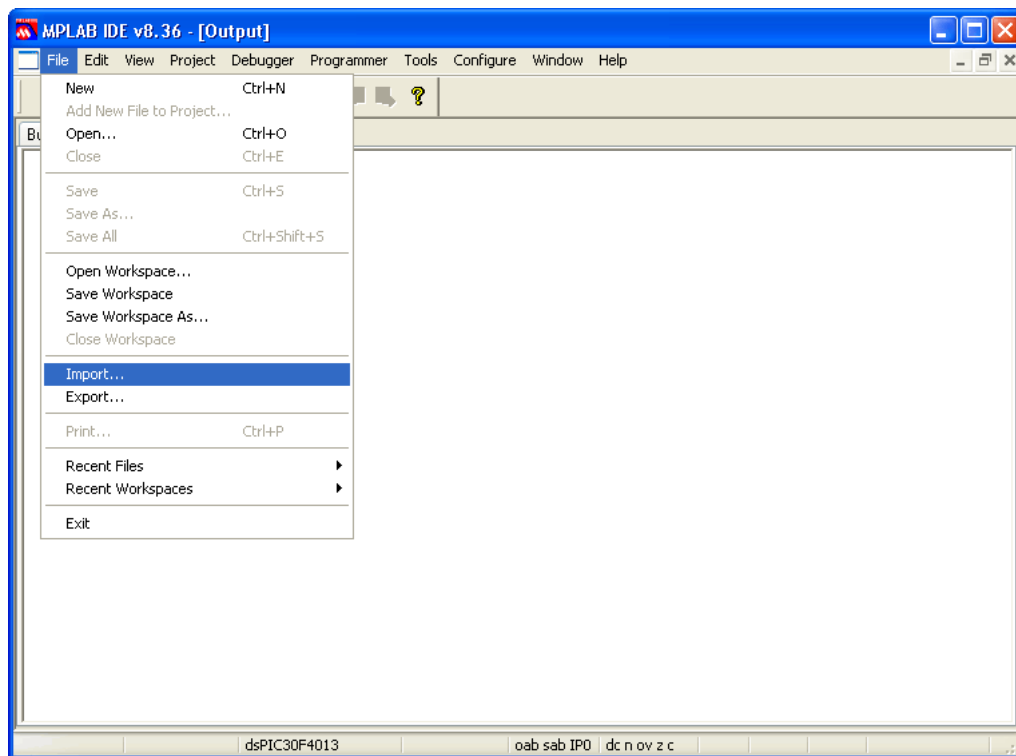

6. Then, select the **MPLAB® SIM** from the **Debugger > Select Tool** menu for software debugging:

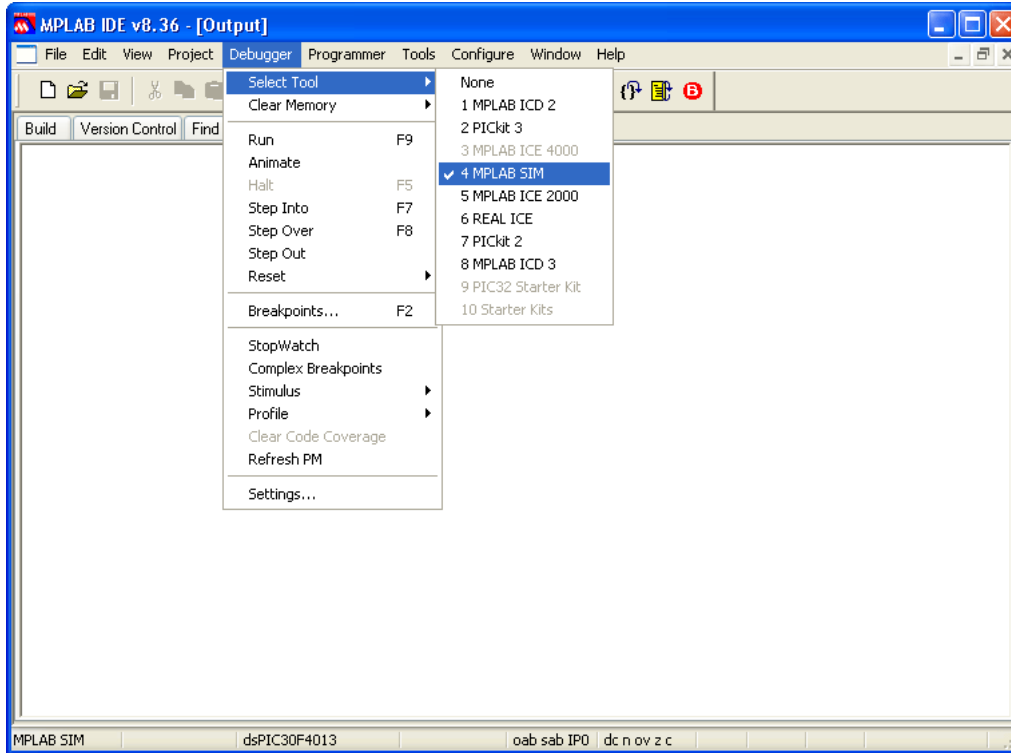

7. Now, you can start debugging the code by clicking Step Over button  on the Debug toolbar, or by pressing F8:

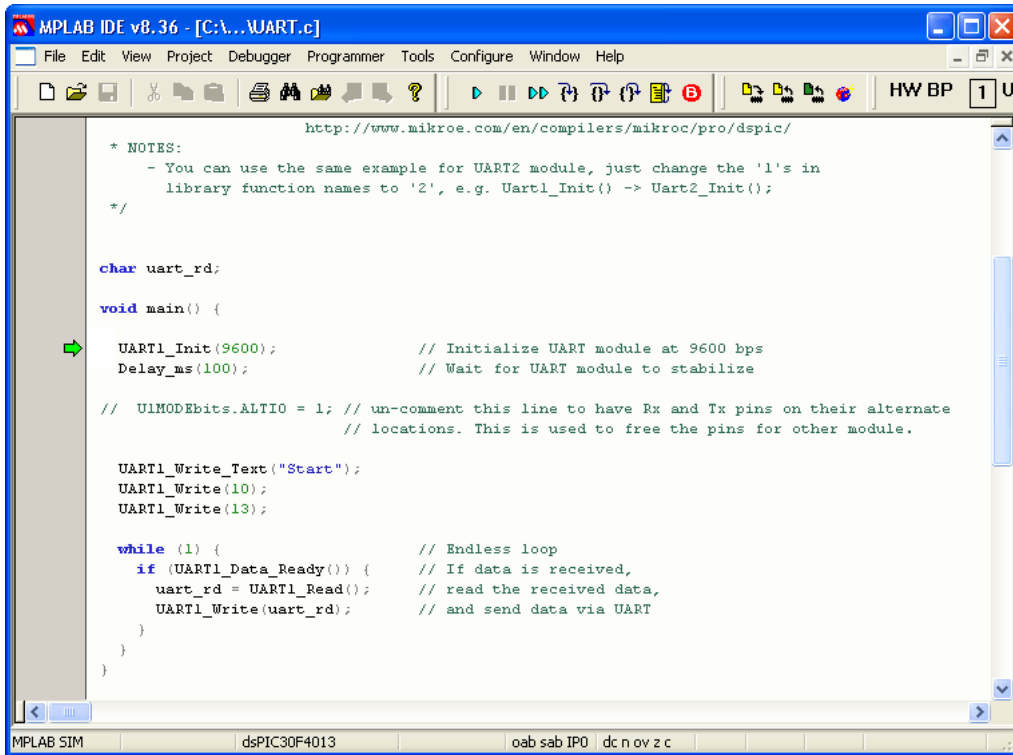

```
http://www.mikroe.com/en/compilers/mikroc/pro/dspic/
* NOTES:
- You can use the same example for UART2 module, just change the '1's in
  library function names to '2', e.g. Uart1_Init() -> Uart2_Init();
*/

char uart_rd;

void main() {
    UART1_Init(9600);           // Initialize UART module at 9600 bps
    Delay_ms(100);             // Wait for UART module to stabilize

    // U1MODEbits.ALTI0 = 1; // un-comment this line to have Rx and Tx pins on their alternate
    // locations. This is used to free the pins for other module.

    UART1_Write_Text("Start");
    UART1_Write(10);
    UART1_Write(13);

    while (1) {                // Endless loop
        if (UART1_Data_Ready()) { // If data is received,
            uart_rd = UART1_Read(); // read the received data,
            UART1_Write(uart_rd);   // and send data via UART
        }
    }
}
```

MPLAB SIM dsPIC30F4013 oab sab IPO dc n ov z c

Related topics: COFF File, Using MPLAB® ICD 2 Debugger

Frequently Asked Questions

This is a list of frequently asked questions about using mikroElektronika compilers. If your question is not answered on this page, please contact mikroElektronika Support Desk.

Can I use your compilers and programmer on Windows Vista (Windows 7) ?

Our compilers and programmer software are developed to work on and tested on Windows 98, Windows 2000, Windows ME, Windows XP (32 and 64 bit), Windows Vista (32 and 64 bit) and Windows 7 (32 and 64 bit) and they work fine on these operating systems.

You can find the latest drivers on our website.

I am getting “Access is denied” error in Vista, how to solve this problem ?

Please turn off User Account Control (UAC). This should make your software fully functional. To do this, follow the path in your Windows Vista (logged in as administrator) **Control Panel** > **User Accounts** > **Turn User Account Control** on or off, uncheck Use User Account Control (UAC) and click OK.

What are differences between mikroC PRO, mikroPascal PRO and mikroBasic PRO compilers ? Why do they have different prices ?

Basically, there is little differences between these compilers. mikroC PRO is standardized with ANSI C, and it is much more complex and it is far more difficult to write the compiler for it. We used a lot more resources for making it than what we used for mikroPascal and mikroBasic. We also worked on some very complex topics such as floating point, typedef, union, a completely new debugger and many other. Because of that there is difference in price.

Why do your PIC compilers don't support 12F508 and some similar chips ?

Unfortunately our PIC compilers don't support 12F508 and similar chips because these chips are designed to use 12-bit wide instructions. Our compiler support MCUs which use 14-bit or wider instructions.

What are limitations of demo versions of mikroElektronika's compilers ?

The only limitation of the free demo version is that it cannot generate hex output over 2K of program words. Although it may sound restrictive, this margin allows you to develop practical, working applications without ever thinking of demo limit. If you intend to develop really complex projects in one of our compilers, you should consider purchasing the license key.

Why do I still get demo limit error when I purchased and installed license key ?

If you are first time installing and registering compiler, you need to follow instructions exactly as described in registration procedure. License is valid only for the computer from which request is made, so license requested from one computer won't work on another computer. You can find on our site manual and video describing in detail how to get your license. If you previously had an older version of our compiler and have working license key for it but it doesn't work with new compiler, you have to repeat registration procedure from the new compiler and you will get a new license.

I have bought license for the older version, do I have to pay license for the new version of the compiler ?

No, once you pay for the license key you get a lifetime license. When we release a new major release of the compiler, you might need to repeat registration procedure from your new compiler and you will get new license free of charge.

Do your compilers work on Windows Vista (Windows 7) ?

Yes!

What does this function/procedure/routine do ?

Please see your compiler's Help where all of the functions are explained in detail.

I try to compile one of the provided examples and nothing happens, what is the problem?

You need to open project, not file. When you want to open an example, go to **Project › Open Project**, then browse through projects and choose project file. Now you will be able to compile and program with success.

Can I get your library sources ? I need to provide all sources with my project.

It is our company's policy not to share our source code.

Can I use code I developed in your compilers in commercial purposes ? Are there some limitations ?

Regarding your code, there are no limitations. Your application is your own property and you can do whatever you like with it. If you want to include some of code we provide with our compilers or on our site, you may include them in your project, however, you are not allowed to charge your users for these.

Why does an example provided with your compilers doesn't work ?

All of the examples provided with our compilers are tested and work fine. You need to read commented header of the example and be sure that you have used the same MCU example is written for and that you have hardware connections (DIP switches, jumpers etc.) set as described.

Your example works if I use the same MCU you did, but how to make it work for another MCU ?

You should read your MCU's datasheet. Different MCUs can have different pin assignments and may require different settings. If you need help regarding this, you can find free online books on our website and recommend you starting there. You can also ask for help on our forum.

I need this project finished, can you help me ?

We currently do not do custom projects, however, we can give you some directions when you start working on your project and come to a problem. Also, our forum is very active community and as you can find there experts in different fields, we encourage you to look for help there.

Do you have some discount on your compilers/development systems for students/professors ?

Since large percentage of our customers are schools, laboratories and students, our prices are already scaled for these kinds of users. If you plan ordering more than one of our products, see special offers page on our website. Also, you can contact our Sales Department and see if you are eligible for some additional discount.

I have a question about your compilers which is not listed here. Where can I find an answer ?

Firstly, look for it in your compiler's Help. If you don't find an answer there, please create a support ticket on our website.



MikroElektronika
SOFTWARE AND HARDWARE SOLUTIONS FOR EMBEDDED WORLD ...making it simple

If you want to learn more about our products, please visit our website at www.mikroe.com

If you are experiencing some problems with any of our products or just need additional information, please place your ticket at www.mikroe.com/en/support

If you have any questions, comments or business proposals, do not hesitate to contact us at office@mikroe.com