

LOC	DIST	REVISIONS					
E	B	P	LTR	DESCRIPTION	DATE	DWN	APVD
			BA	NEW RELEASE	04-NOV-08	SM	St.P

FOR FURTHER INFORMATION SEE DATA SHEET FOR
CRG SERIES-THICK FILM CHIP RESISTORS

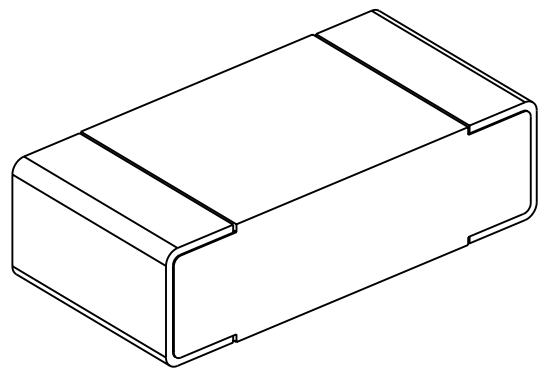
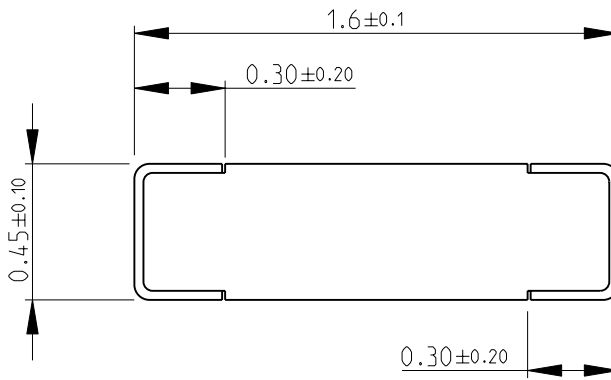
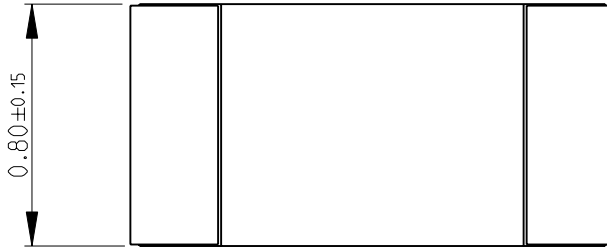

RoHS Compliant

2008

RELEASED FOR PUBLICATION

THIS DRAWING IS UNPUBLISHED.

© COPYRIGHT 2008 BY TYCO ELECTRONICS CORPORATION. ALL RIGHTS RESERVED.

DIMENSIONS: mm	DWN	04-NOV-08	MATERIAL	-	FINISH	-
	CHK	04-NOV-08	Tyco Electronics Corporation Dorcan, Swindon, SN3 5HH			
TOLERANCES UNLESS OTHERWISE SPECIFIED:	APVD	04-NOV-08				
0 PLC ±0.5	STEPHEN.P		NAME THICK FILM CHIP RESISTORS SERIES CRG 0603			
1 PLC ±0.2	PRODUCT SPEC	-				
2 PLC ±0.1	APPLICATION SPEC	-	SIZE	CAGE CODE	DRAWING NO	RESTRICTED TO
3 PLC ±-	WEIGHT	-	A 4	00779	© = 1622944	-
4 PLC ±-			CUSTOMER DRAWING			
ANGLES ±5°			SCALE	40:1	SHEET	1 OF 1
			REV BA			