

# SM05T1 Series

Preferred Device

## Transient Voltage Suppressor Diode Array

### SOT-23 Dual Common Anode Zeners for ESD Protection

These dual monolithic silicon zener diodes are designed for applications requiring transient overvoltage protection capability. They are intended for use in voltage and ESD sensitive equipment such as computers, printers, business machines, communication systems, medical equipment and other applications. Their dual junction common anode design protects two separate lines using only one package. These devices are ideal for situations where board space is at a premium.

#### Specification Features:

- SOT-23 Package Allows Either Two Separate Unidirectional Configurations or a Single Bidirectional Configuration
- Working Peak Reverse Voltage Range - 5.0 V to 12 V
- Peak Power - 300 Watt (8 X 20  $\mu$ s)
- Low Leakage
- Flammability Rating UL 94 V-0

#### Mechanical Characteristics:

**CASE:** Void-free, transfer-molded, thermosetting plastic case

**FINISH:** Corrosion resistant finish, easily solderable

**MAXIMUM CASE TEMPERATURE FOR SOLDERING PURPOSES:**  
260°C for 10 Seconds

Package designed for optimal automated board assembly  
Small package size for high density applications  
Available in 8 mm Tape and Reel

Use the Device Number to order the 7 inch/3,000 unit reel.  
Replace the "T1" with "T3" in the Device Number to order the 13 inch/10,000 unit reel.



ON Semiconductor®

<http://onsemi.com>

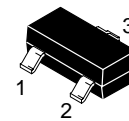
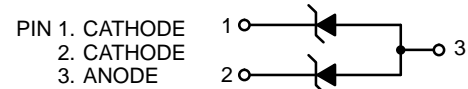

SOT-23  
CASE 318  
STYLE 12

#### MARKING DIAGRAM

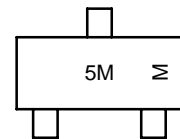

5M = Device Code  
M = Date Code

#### ORDERING INFORMATION

| Device | Package | Shipping         |
|--------|---------|------------------|
| SM05T1 | SOT-23  | 3000/Tape & Reel |
| SM12T1 | SOT-23  | 3000/Tape & Reel |

Preferred devices are recommended choices for future use and best overall value.

# SM05T1 Series

## MAXIMUM RATINGS

| Rating  | Symbol          | Value                 | Unit                       |
|---|-----------------|-----------------------|----------------------------|
| Peak Power Dissipation @ 20 $\mu$ s (Note 1)<br>@ $T_L \leq 25^\circ\text{C}$                                       | $P_{pk}$        | 300                   | Watts                      |
| IEC 61000-4-2 (ESD) Air Contact   |                 | $\pm 15$<br>$\pm 8.0$ | kV                         |
| IEC 61000-4-4 (EFT)   |                 | 40                    | A                          |
| IEC 61000-4-5 (Lightening)  |                 | 12                    | A                          |
| Total Power Dissipation on FR-5 Board (Note 2) @ $T_A = 25^\circ\text{C}$<br>Derate above $25^\circ\text{C}$        | $P_D$           | 225<br>1.8            | mW<br>mW/ $^\circ\text{C}$ |
| Thermal Resistance Junction to Ambient  | $R_{\theta JA}$ | 556                   | $^\circ\text{C/W}$         |
| Total Power Dissipation on Alumina Substrate (Note 3) @ $T_A = 25^\circ\text{C}$<br>Derate above $25^\circ\text{C}$ | $P_D$           | 300<br>2.4            | mW<br>mW/ $^\circ\text{C}$ |
| Thermal Resistance Junction to Ambient  | $R_{\theta JA}$ | 417                   | $^\circ\text{C/W}$         |
| Junction and Storage Temperature Range  | $T_J, T_{stg}$  | - 55 to +150          | $^\circ\text{C}$           |
| Lead Solder Temperature - Maximum (10 Second Duration)  | $T_L$           | 260                   | $^\circ\text{C}$           |

1. Non-repetitive current pulse per Figure 3
  2. FR-5 = 1.0 x 0.75 x 0.62 in.
  3. Alumina = 0.4 x 0.3 x 0.024 in., 99.5% alumina
- \*Other voltages may be available upon request

## ELECTRICAL CHARACTERISTICS

( $T_A = 25^\circ\text{C}$  unless otherwise noted)

**UNIDIRECTIONAL** (Circuit tied to Pins 1 and 3 or 2 and 3)

| Symbol          | Parameter                                   |
|-----------------|---|
| $I_{PP}$        | Maximum Reverse Peak Pulse Current          |
| $V_C$           | Clamping Voltage @ $I_{PP}$                 |
| $V_{RWM}$       | Working Peak Reverse Voltage                |
| $I_R$           | Maximum Reverse Leakage Current @ $V_{RWM}$ |
| $V_{BR}$        | Breakdown Voltage @ $I_T$                   |
| $I_T$           | Test Current                                |
| $\Theta V_{BR}$ | Maximum Temperature Coefficient of $V_{BR}$ |
| $I_F$           | Forward Current                             |
| $V_F$           | Forward Voltage @ $I_F$                     |
| $Z_{ZT}$        | Maximum Zener Impedance @ $I_{ZT}$          |
| $I_{ZK}$        | Reverse Current                             |
| $Z_{ZK}$        | Maximum Zener Impedance @ $I_{ZK}$          |

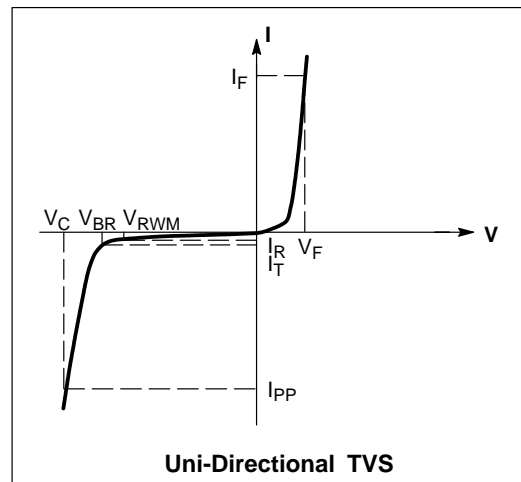

## ELECTRICAL CHARACTERISTICS

| Device | Device Marking | $V_{RWM}$<br>(Volts) | $I_R$ @ $V_{RWM}$<br>( $\mu\text{A}$ ) | $V_{BR}$ , Breakdown Voltage |       | $I_T$<br>mA | $V_C$ @<br>$I_{PP} = 1$ Amp<br>(Volts) | Max $I_{PP}$<br>(Note 4)<br>(Amps) | Typical Capacitance     |
|--------|----------------|----------------------|--|------------------------------|-------|-------------|--|------------------------------------|-------------------------|
|        |                |                      |  | (Volts)                      |       |             |  |                                    | (pF)                    |
|        |                |                      |  | Min                          | Max   |             |  |                                    | Pin 1 to 3<br>@ 0 Volts |
| SM05T1 | 5M             | 5                    | 10                                     | 6.2                          | 7.3   | 1.0         | 9.8                                    | 17                                 | 225                     |
| SM12T1 | 12M            | 12                   | 1.0                                    | 13.3                         | 15.75 | 1.0         | 19                                     | 12                                 | 95                      |

4.  $8 \times 20 \mu\text{s}$  pulse waveform per Figure 3

# SM05T1 Series

## TYPICAL CHARACTERISTICS

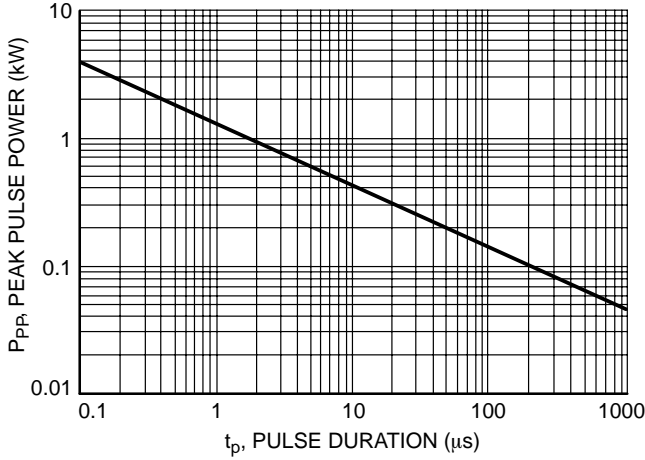

Figure 1. Non-Repetitive Peak Pulse Power versus Pulse Time

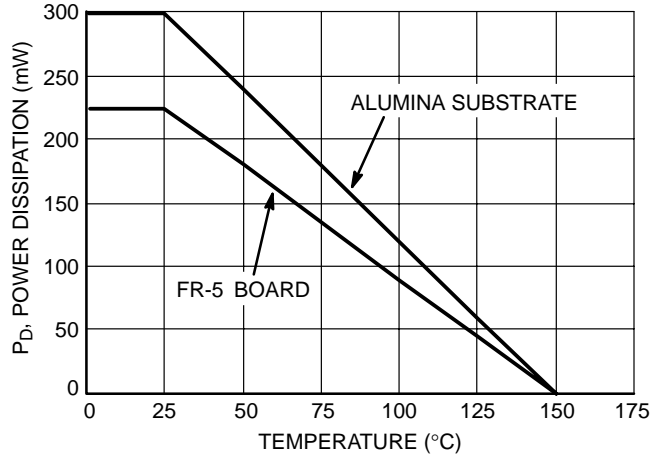

Figure 2. Steady State Power Derating Curve

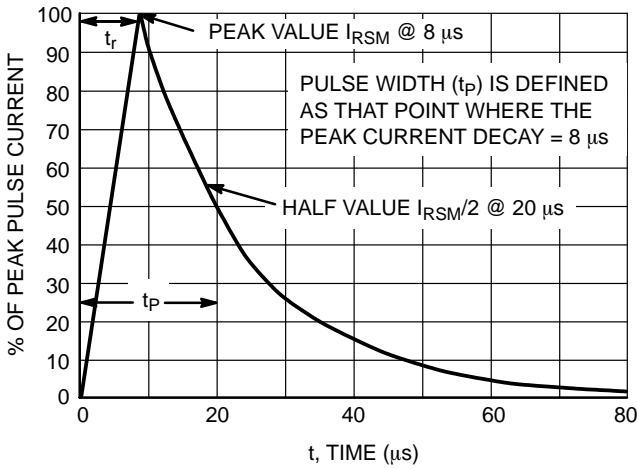

Figure 3. 8 x 20 μs Pulse Waveform

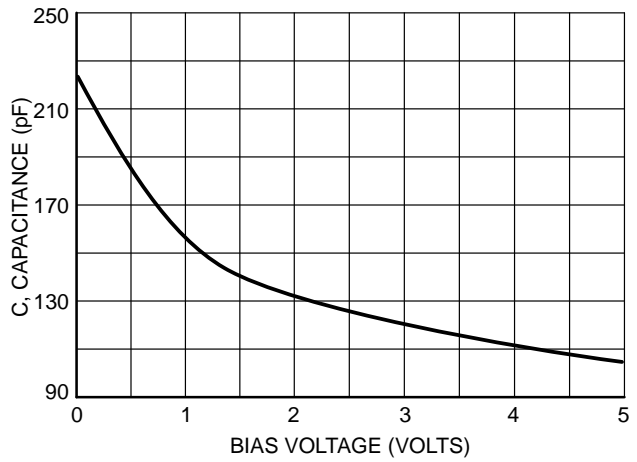

Figure 4. Typical Diode Capacitance (SM05)

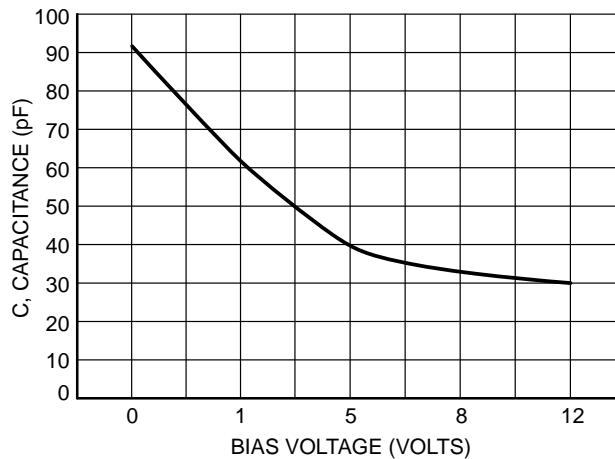

Figure 5. Typical Diode Capacitance (SM12)

# SM05T1 Series

## TYPICAL COMMON ANODE APPLICATIONS

A quad junction common anode design in a SOT-23 package protects four separate lines using only one package. This adds flexibility and creativity to PCB design especially

when board space is at a premium. Two simplified examples of TVS applications are illustrated below.

### Computer Interface Protection

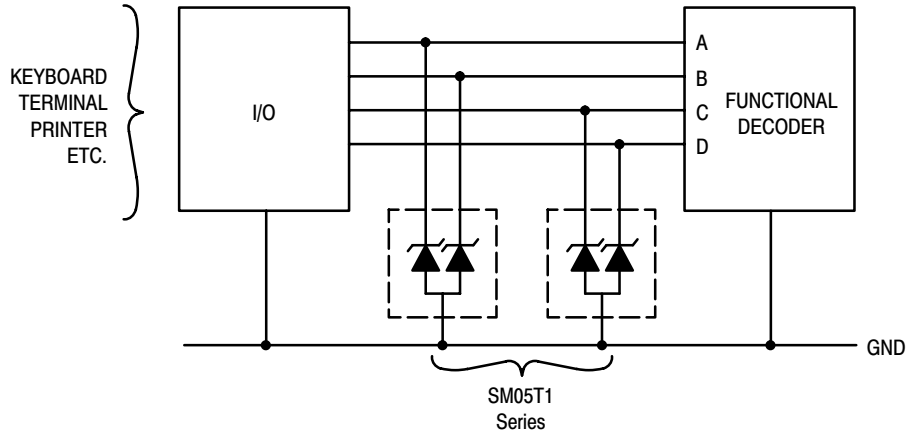

### Microprocessor Protection

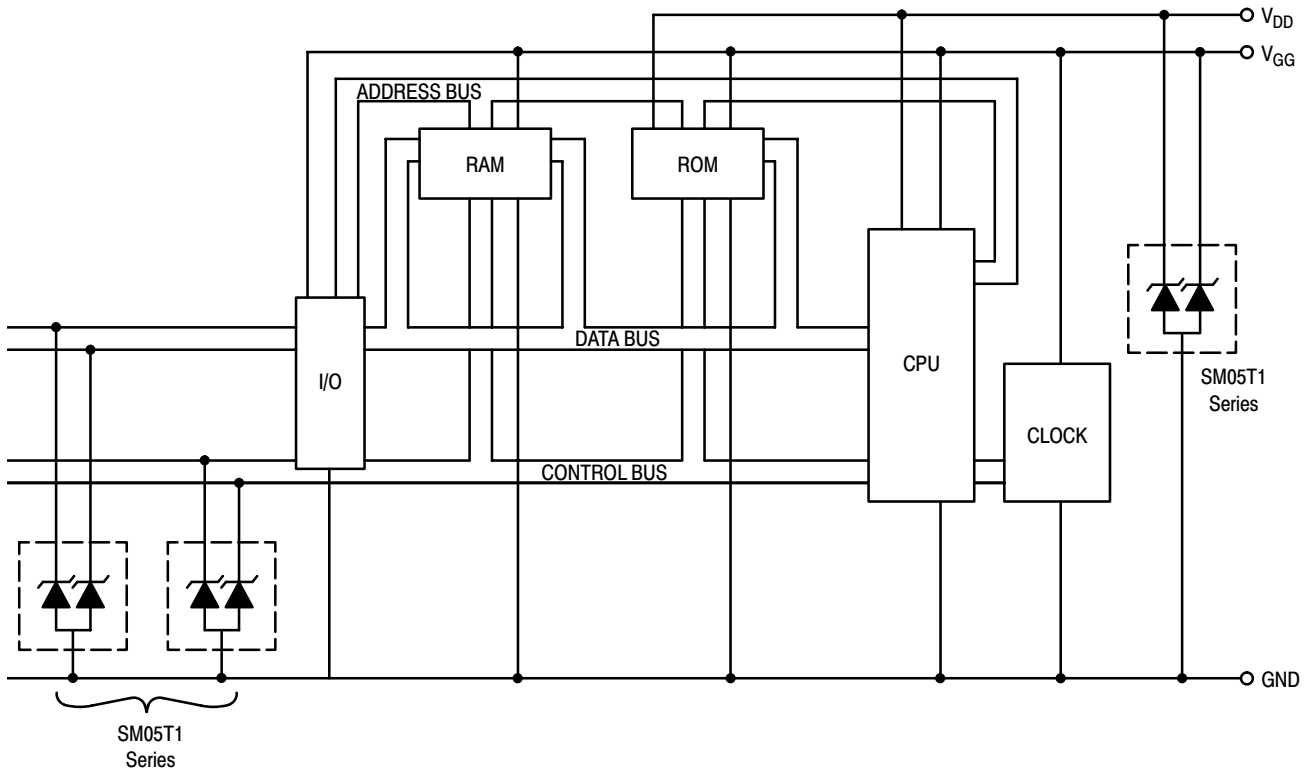

**INFORMATION FOR USING THE SOT-23 SURFACE MOUNT PACKAGE**

**MINIMUM RECOMMENDED FOOTPRINT FOR SURFACE MOUNTED APPLICATIONS**

Surface mount board layout is a critical portion of the total design. The footprint for the semiconductor packages must be the correct size to insure proper solder connection

interface between the board and the package. With the correct pad geometry, the packages will self align when subjected to a solder reflow process.

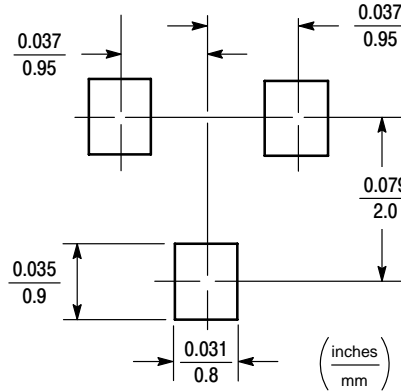

**SOT-23**

**SOT-23 POWER DISSIPATION**

The power dissipation of the SOT-23 is a function of the drain pad size. This can vary from the minimum pad size for soldering to a pad size given for maximum power dissipation. Power dissipation for a surface mount device is determined by  $T_{J(max)}$ , the maximum rated junction temperature of the die,  $R_{\theta JA}$ , the thermal resistance from the device junction to ambient, and the operating temperature,  $T_A$ . Using the values provided on the data sheet for the SOT-23 package,  $P_D$  can be calculated as follows:

$$P_D = \frac{T_{J(max)} - T_A}{R_{\theta JA}}$$

The values for the equation are found in the maximum ratings table on the data sheet. Substituting these values into the equation for an ambient temperature  $T_A$  of 25°C, one can calculate the power dissipation of the device which in this case is 225 milliwatts.

$$P_D = \frac{150^\circ\text{C} - 25^\circ\text{C}}{556^\circ\text{C/W}} = 225 \text{ milliwatts}$$

The 556°C/W for the SOT-23 package assumes the use of the recommended footprint on a glass epoxy printed circuit board to achieve a power dissipation of 225 milliwatts. There are other alternatives to achieving higher power dissipation from the SOT-23 package. Another alternative would be to use a ceramic substrate or an aluminum core board such as Thermal Clad®. Using a board material such as Thermal Clad, an aluminum core board, the power dissipation can be doubled using the same footprint.

**SOLDERING PRECAUTIONS**

The melting temperature of solder is higher than the rated temperature of the device. When the entire device is heated to a high temperature, failure to complete soldering within a short time could result in device failure. Therefore, the following items should always be observed in order to minimize the thermal stress to which the devices are subjected.

- Always preheat the device.
- The delta temperature between the preheat and soldering should be 100°C or less.\*
- When preheating and soldering, the temperature of the leads and the case must not exceed the maximum temperature ratings as shown on the data sheet. When using infrared heating with the reflow soldering method, the difference shall be a maximum of 10°C.
- The soldering temperature and time shall not exceed 260°C for more than 10 seconds.
- When shifting from preheating to soldering, the maximum temperature gradient shall be 5°C or less.
- After soldering has been completed, the device should be allowed to cool naturally for at least three minutes. Gradual cooling should be used as the use of forced cooling will increase the temperature gradient and result in latent failure due to mechanical stress.
- Mechanical stress or shock should not be applied during cooling.

\* \* Soldering a device without preheating can cause excessive thermal shock and stress which can result in damage to the device.

# SM05T1 Series

## PACKAGE DIMENSIONS

SOT-23  
TO-236AB  
CASE 318-08  
ISSUE AH

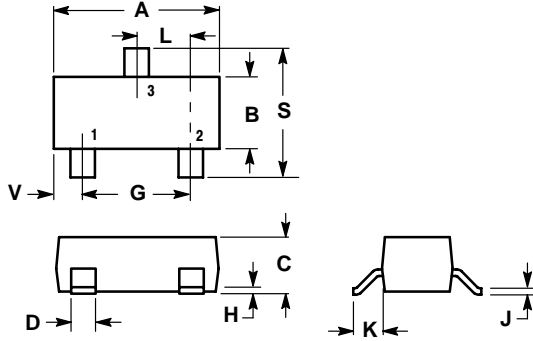

### NOTES:

1. DIMENSIONING AND TOLERANCING PER ANSI Y14.5M, 1982.
2. CONTROLLING DIMENSION: INCH.
3. MAXIMUM LEAD THICKNESS INCLUDES LEAD FINISH THICKNESS. MINIMUM LEAD THICKNESS IS THE MINIMUM THICKNESS OF BASE MATERIAL.
4. 318-03 AND -07 OBSOLETE, NEW STANDARD 318-08.

| DIM | INCHES |        | MILLIMETERS |       |
|-----|--------|--------|-------------|-------|
|     | MIN    | MAX    | MIN         | MAX   |
| A   | 0.1102 | 0.1197 | 2.80        | 3.04  |
| B   | 0.0472 | 0.0551 | 1.20        | 1.40  |
| C   | 0.0350 | 0.0440 | 0.89        | 1.11  |
| D   | 0.0150 | 0.0200 | 0.37        | 0.50  |
| G   | 0.0701 | 0.0807 | 1.78        | 2.04  |
| H   | 0.0005 | 0.0040 | 0.013       | 0.100 |
| J   | 0.0034 | 0.0070 | 0.085       | 0.177 |
| K   | 0.0140 | 0.0285 | 0.35        | 0.69  |
| L   | 0.0350 | 0.0401 | 0.89        | 1.02  |
| S   | 0.0830 | 0.1039 | 2.10        | 2.64  |
| V   | 0.0177 | 0.0236 | 0.45        | 0.60  |

### STYLE 12:

- PIN 1. CATHODE
- CATHODE
- ANODE

Thermal Clad is a registered trademark of the Bergquist Company.

**ON Semiconductor** and  are registered trademarks of Semiconductor Components Industries, LLC (SCILLC). SCILLC reserves the right to make changes without further notice to any products herein. SCILLC makes no warranty, representation or guarantee regarding the suitability of its products for any particular purpose, nor does SCILLC assume any liability arising out of the application or use of any product or circuit, and specifically disclaims any and all liability, including without limitation special, consequential or incidental damages. "Typical" parameters which may be provided in SCILLC data sheets and/or specifications can and do vary in different applications and actual performance may vary over time. All operating parameters, including "Typicals" must be validated for each customer application by customer's technical experts. SCILLC does not convey any license under its patent rights nor the rights of others. SCILLC products are not designed, intended, or authorized for use as components in systems intended for surgical implant into the body, or other applications intended to support or sustain life, or for any other application in which the failure of the SCILLC product could create a situation where personal injury or death may occur. Should Buyer purchase or use SCILLC products for any such unintended or unauthorized application, Buyer shall indemnify and hold SCILLC and its officers, employees, subsidiaries, affiliates, and distributors harmless against all claims, costs, damages, and expenses, and reasonable attorney fees arising out of, directly or indirectly, any claim of personal injury or death associated with such unintended or unauthorized use, even if such claim alleges that SCILLC was negligent regarding the design or manufacture of the part. SCILLC is an Equal Opportunity/Affirmative Action Employer.

## PUBLICATION ORDERING INFORMATION

### Literature Fulfillment:

Literature Distribution Center for ON Semiconductor  
P.O. Box 5163, Denver, Colorado 80217 USA  
Phone: 303-675-2175 or 800-344-3860 Toll Free USA/Canada  
Fax: 303-675-2176 or 800-344-3867 Toll Free USA/Canada  
Email: ONlit@hibbertco.com

**N. American Technical Support:** 800-282-9855 Toll Free USA/Canada

**JAPAN:** ON Semiconductor, Japan Customer Focus Center  
2-9-1 Kamimeguro, Meguro-ku, Tokyo, Japan 153-0051  
Phone: 81-3-5773-3850

**ON Semiconductor Website:** <http://onsemi.com>

For additional information, please contact your local Sales Representative.