

***Bluetooth*[®] low energy Module**

Bluetooth[®] 4.2 low energy

EYSGCNAWY-1X

Data Report

The **Bluetooth**[®] word mark and logos are owned by the **Bluetooth** SIG, Inc. and any use of such marks by TAIYO YUDEN CO., LTD. is under license.

EYSGCNAWY-1X

TAIYO YUDEN

Document constituent list

Control name	Control No.	Document Page
General Items	HD-AG-A150104	1/5 - 5/5
Absolute maximum ratings	HD-AM-A150104	1/1
Electrical characteristics	HD-AE-A150104	1/2 - 2/2
Circuit schematic	HD-MC-A150104	1/3 - 3/3
Outline / Appearance	HD-AD-A150104	1/3 - 3/3
Pin Layout	HD-BA-A150104	1/1
Handling Precaution	HQ-BA-537	1/2 - 2/2
Packaging Specification	HD-BB-A150104	1/3 - 3/3
Antenna application note		1/3 - 3/3
Design guide		1/1
Software manual		1/23 - 23/23

Revision History

- 14-Sep.-2015 > Ver.1.00 Release
- 21-Dec.-2015 > Ver.1.01 Update
- 18-Mar.-2016 > Ver.1.1 Update
- 12-Jul.-2016 > Ver.1.2 Update
- 09-Aug.-2016 > Ver.1.3 Update

EYSGCNAWY-1X

TAIYO YUDEN

Control No. HD-AG-A150104	(1/5)	Control name General Items
------------------------------	-------	-------------------------------

Scope

This specification ("Specification") applies to the hybrid IC "EYSGCNAWY-1X", a **Bluetooth**[®] 4.2 low energy module ("Product") manufactured by TAIYO YUDEN Co., Ltd. ("TAIYO YUDEN")

1. Type: EYSGCN

User Code: EYSGCNAWY-1X

*User Code may be changed for mass production or other cases.

2. Function:

Radio frequency module. **Bluetooth**[®] standard Ver 4.2 low energy conformity

3. Application: Health & Fitness Equipment, Sensor, Toys

4. Structure:

Hybrid IC loaded with silicon monolithic semiconductor

Compatible with industrial standard reflow profile for Pb-free solders

Can meet with RoHS compliance (Pb, Cd, Hg, Cr⁺⁶, PBB, PBDE)

5. Outline: 12.9x 9.6 x 2.0 mm

49-pin Land Grid Array

6. Marking: Part number, Lot number, Japan ID, FCC ID, IC ID

7. Features:

- Small outline by PCB substrate
- Low power consumption
- Integrated antenna
- Integrated system and sleep clock
- **Bluetooth**[®] 4.2 low energy conformity
 - Slave or Master Role

8. Packaging:

Packaging method: Tape & reel + aluminum moisture barrier bag

Packaging unit: 1000

*It might be provided as tray at sample stage.

TAIYO YUDEN

EYSGCNAWY-1X

TAIYO YUDEN

Control No. HD-AG-A150104	(2/5)	Control name General Items
------------------------------	-------	-------------------------------

9. Note:

- a. Any question arising from this Specification shall be solved through mutual discussion by the parties hereof.
- b. This Product is not designed to be radiation durable and should not be used under the circumstance of radiation.
- c. The operating conditions of this Product are as shown in this Specification. Please note that TAIYO YUDEN shall not be liable for a failure and/or abnormality which is caused by use under the conditions other than the operating conditions hereof.
- d. The Product mentioned in this Specification is manufactured for use in Health & Fitness Equipment, Sensor and Toys. Before using this Product in any special equipment (such as medical equipment, space equipment, air craft, disaster prevention equipment), where higher safety and reliability are duly required, the applicability and suitability of this Product must be fully evaluated by the customer at its sole risk to ensure correct and safe operation of these special equipments. Also, evaluation of the safety function of this Product even for use in general electronics equipment shall be thoroughly made and when necessary, a protective circuit shall be added during the design stage, all at the customer's sole risk.
- e. a) You are requested to fully check and confirm by the start of mass production of this Product that (1) no bug, defect or other failure is included in firmware incorporated in this Product ("Incorporated Software"), (2) no bug defect or other failure arising from installation of this Product in which is contained Incorporated Software into your products is included in Incorporated Software, and that Incorporated Software fully meets your intended use, although TAIYO YUDEN sufficiently inspects or verifies quality of Incorporated Software.
b) Please note that TAIYO YUDEN is not responsible for any failure arising out of bugs or defects in Incorporated Software.
- f. TAIYO YUDEN warrants only that this Product is in conformity with this Specification for one year after purchase and shall in no event give any other warranty.
- g. Communication between this Product and others might not be established nor maintained depending on radio environment or operating conditions of this Product and other *Bluetooth*[®] products.
- h. In order to test for Radio Law certification with a device incorporating this module, the Host Software must be able to put the module into test mode. Please contact TAIYO YUDEN for further details.
- i. This Product operates in the unlicensed ISM band at 2.4GHz. In case this Product is used around the other wireless devices which operate in same frequency band of this Product, there is a possibility that interference may occur between this Product and such other devices. If such interference occurs, please stop the operation of other devices or relocate this Product before using this Product or do not use this Product around the other wireless devices.
- j. Please thoroughly evaluate our module with your products before going mass production.
- k. User Code Modification Notice.
User Code for sample modules or part numbers in this Specification are TAIYO YUDEN standard part numbers. When any modification is made to a module to meet requested specifications, the part number will be changed. Please contact TAIYO YUDEN to confirm whether your part number needs to be modified.

Please see the following examples for cases when part numbers are modified:

- for specific firmware version (our standard item firmware will be upgraded occasionally)
- for other relevant cases (specific or different setting, form, sizes, or display etc..)

TAIYO YUDEN

EYSGCNAWY-1X

TAIYO YUDEN

Control No. HD-AG-A150104	(3/5)	Control name General Items
------------------------------	-------	-------------------------------

- l. Alternative components may used to this module. The intended components is used within the warranty written in this document (characteristics, size, operating condition, reliability, public regulation such as radio type approval) and Taiyo Yuden confirmed there are not any problems with the replacement. The traceability of the components is secured each production lot.
- m. Caution for Export Control
This Product may be subject to governmental approvals, consents, licenses, authorizations, declarations, filings, and registrations for export or re-export of the Product, required by Japanese Foreign Exchange and Foreign Trade Law (including related laws and regulations) and/or any other country's applicable laws or regulations related to export control.
If you plan to export or re-export this Product, it is strongly recommended that you check and confirm, the necessary procedures to export or re-export of this Product as required by applicable laws and regulations, and if necessary, you have to obtain necessary and appropriate approvals or licenses from governmental authority at your own risk and expense.
- n. Japan Regulatory Information
This module is approved with the specific antenna on this module.
a) Please ensure that your product can bear a label with the following information. If the product is so small that it is not practicable to place the label, please place it in the instruction manual and package.
This product installs a radio system which has been approved as a radio station in a low power data communication system based on the Radio Law.
EYSGCN : 001-A06158
- o. Canada Regulatory Information
a) This device complies with Industry Canada license-exempt RSS standards. Operation is subject to the following two conditions: (1) this device may not cause interference, and (2) this device must accept any interference, including interference that may cause undesired operation of the device.
L'utilisation de ce dispositif est autorisée seulement aux conditions suivantes: (1) il ne doit pas produire de brouillage et (2) l'utilisateur du dispositif doit être prêt à accepter tout brouillage radioélectrique reçu, même si ce brouillage est susceptible de compromettre le fonctionnement du dispositif.
b) This product is certified as type of the portable device with Industry Canada Rules. To maintain compliance with RF Exposure requirement, please use within specification of this product.
Ce produit est certifié comme type de l'appareil portable avec Industrie Règles de Canada. Pour maintenir l'acquiescement avec exigence Exposition de RF, veuillez utiliser dans spécification de ce produit.
- IC: 4389B-EYSGCN
c) Please notify certified ID by either one of the following method on your product.
Specifiez ID certifiée dans votre produit par une de méthode suivante.
-Contains Transmitter module IC : 4389B-EYSGCN
-Contains IC : 4389B-EYSGCN

TAIYO YUDEN

EYSGCNAWY-1X

TAIYO YUDEN

Control No. HD-AG-A150046	(4/5)	Control name General Items
------------------------------	-------	-------------------------------

- p. FCC Regulatory Information
- This device complies with part 15 of the FCC Rules. Operation is subject to the following two conditions: (1) This device may not cause harmful interference, and (2) this device must accept any interference received, including interference that may cause undesired operation.
 - Please notify certified ID by either one of the following method on your product.
 - Contains Transmitter Module FCC ID: RYYEYSGCN
 - Contains FCC ID: RYYEYSGCN
 - CAUTION: changes or modifications not expressly approved by the party responsible for compliance could void the use's authority to operate the equipment.
 - This product is certified as type of the portable device with FCC Rules. To maintain compliance with RF Exposure requirement, please use within specification of this product.
 - The antenna used for this transmitter must not be co-located or operating in conjunction with any other antenna or transmitter.
- q. CE Regulatory Information
- When your end product installs this module, it is required to proceed additional certification processes before placing on the market in EU member states to make your products fully comply with relative EU standards.
 - TAIYO YUDEN can provide you the test reports of conducted measurement portion for the radio module. You can utilize the test reports for the certification processes of your end product as it requires radio testing.
- r. This Product is designed for use in products which comply with *Bluetooth*[®] Specifications (Ver 4.2 LE) ("Bluetooth Specifications"). TAIYO YUDEN disclaims and is not responsible for any liability concerning infringement by this Product under any intellectual property right owned by third party in case the customer uses this Product in any product which does not comply with Bluetooth Specifications (the "non-complying products"). Furthermore, TAIYO YUDEN warrants only that this Product complies with this Specification and does not grant any other warranty including warranty for application of the non-complying products.
- s. EYSGCN series module is qualified as PHY only with Component category by Bluetooth SIG. The QDID of this module is 72109. The final product needs to get qualification as End product combining with PHY (module), SoftDevice and Profile before selling the product. The QDID of this product is Link Layer Master : 54056, Slave : 61110 and Host Layer Master : 66320, Slave : 56948. Please refer to following combination and consult with your qualification body and BQE.

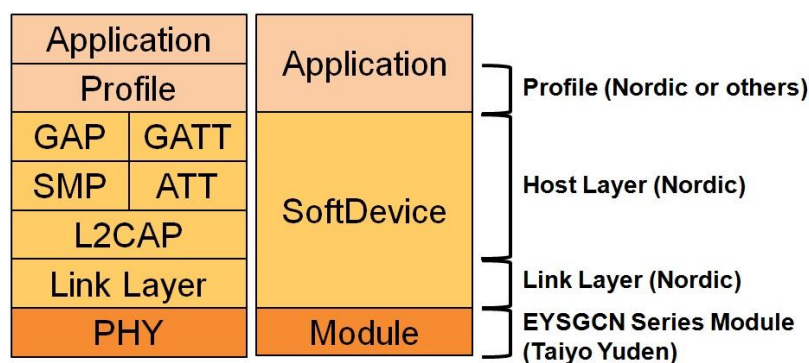

TAIYO YUDEN

EYSGCNAWY-1X

TAIYO YUDEN

Control No. HD-AG-A150046	(5/5)	Control name General Items
------------------------------	-------	-------------------------------

The use of Embedded Software
Before using this product.

Please kindly read carefully and understand the following before using the Products.

1. Taiyo Yuden Co., Ltd. (hereinafter "TY"), lawfully has copyrights and other rights to the software embedded to the memory of the Products (the "Embedded Software"). Except as otherwise expressly provided herein, your company is not permitted to disclose or offer the Embedded Software, either wholly or partly, to any third party (including uploading to your company or third party (ies)'s web sites and downloading by third parties from such sites), nor to copy, revise, reverse engineer, upgrade, make specification change, or alienate the Embedded Software.
2. Before using the Products, you need to check and confirm sufficient safety and operation of your products which incorporate the Products and interoperability and compatibility with other Bluetooth[®] enabled products.
3. TY have not evaluated and confirmed the interoperability, compatibility, etc. of the Products (including Embedded Software) with every kind of Bluetooth[®] enabled product. In addition, TY does not guarantee interoperability and compatibility of the Product with certain devices. In order to minimize the damage or harm arising out of the Potential Failure or out of combination with other devices, TY recommend your company set up interface or external pin (for detail, please refer to Specification " Pin Layout " of this document) for rewriting the Embedded Software.

EYSGCNAWY-1X

TAIYO YUDEN

Control No. HD-AM-A150104	(1/1)	Control name Absolute maximum ratings
------------------------------	-------	--

Absolute maximum ratings

Symbol	Parameter	Min.	Max.	Units
VCC_NRF		-0.3	+3.6	V
GND			0	V
VIO		-0.3	VCC_NRF+ 0.3	V
Storage temperature		-40	+85	Deg-C
MSL	Moisture Sensitivity Level	3		
ESD HBM	Human Body Model		1	kV
ESD MM	Machine Model		100	V
Endurance	Flash Memory Endurance	20000		write/erase cycles
Retention	Flash Memory Retention	10 years		At 40 deg-C
Number of times an address can be written between erase cycles			2	times

TAIYO YUDEN

EYSGCNAWY-1X

TAIYO YUDEN

Control No. HD-AE-A150104	(1/2)	Control name Electrical characteristics
------------------------------	-------	--

Electrical characteristics**Recommendation operating range**

Symbol	Parameter	Min.	Typ.	Max.	Units
VCC_NRF	Supply voltage, normal mode	1.8	3.0	3.6	V
tR_VCC_NRF	Supply rise time (0V to 1.8V)*1			100	ms
TA	Operation temperature	-25	25	75	Deg-C

*1 The on-chip power-on reset circuitry may not function properly for rise times outside the specified interval. Also after power off, it must start up from below 0.3V. The on-chip power-on reset circuitry may not function properly.

DC Specifications

The Specification applies for Topr.= 25 degrees C, VCC_NRF = 3.0V

Symbol	Parameter (condition)	Min.	Typ.	Max.	Units
VIH	Input high voltage	0.7 VCC_NRF		VCC_NRF	V
VIL	Input low voltage	GND		0.3 VCC_NRF	V
VOH	Output high voltage (std. drive, 0.5 mA)	VCC_NRF-0.3		VCC_NRF	V
VOH	Output high voltage (high-drive, 5 mA)	VCC_NRF-0.3		VCC_NRF	V
VOL	Output low voltage (std. drive, 0.5 mA)	GND		0.3	V
VOL	Output low voltage (high-drive, 5 mA)	GND		0.3	V
RPU	Pull-up resistance	11	13	16	kohm
RPD	Pull-down resistance	11	13	16	kohm
ITX,+4dBm	TX only run current @ POUT =+4 dBm		16		mA
IRX	RX only run current		13		mA
IOFF	Current in SYSTEM-OFF, no RAM retention		0.6		uA
RSTR	RESET High to Module Ready		300	600	ms
RPW	RESET Pulse Width		5		ms

UART specifications

Symbol	Description	Min.	Typ.	Max.	Units
f _{UART}	Baud rate for UART		38400		bps

TAIYO YUDEN

EYSGCNAWY-1X

TAIYO YUDEN

Control No. HD-AE-A150104	(2/2)	Control name Electrical characteristics
------------------------------	-------	--

RF Specifications

Symbol	Description	Min.	Typ.	Max.	Units
Fop	Operating frequencies	2402		2480	MHz
Df	Frequency deviation	+/-225	+/-250	+/-275	kHz
PRF	Maximum output power		4		dBm
PRFCR	RF power accuracy			+/-4	dB
PBW	20 dB bandwidth for modulated carrier		950	1100	kHz
PRF1	1st Adjacent Channel Transmit Power 1 MHz			-20	dBc
PRF2	2nd Adjacent Channel Transmit Power 2 MHz			-45	dBc
PRXMAX	Maximum received signal strength at < 0.1% PER		0		dBm
PSENS IT	Receiver sensitivity (0.1% BER) Ideal transmitter		-93		dBm
PSENS DT	Receiver sensitivity (0.1% BER) dirty transmitter		-91		dBm

EYSGCNAWY-1X

TAIYO YUDEN

Control No. HD-MC-A150104	(1/3)	Control name Circuit Schematic
------------------------------	-------	-----------------------------------

Block Diagram

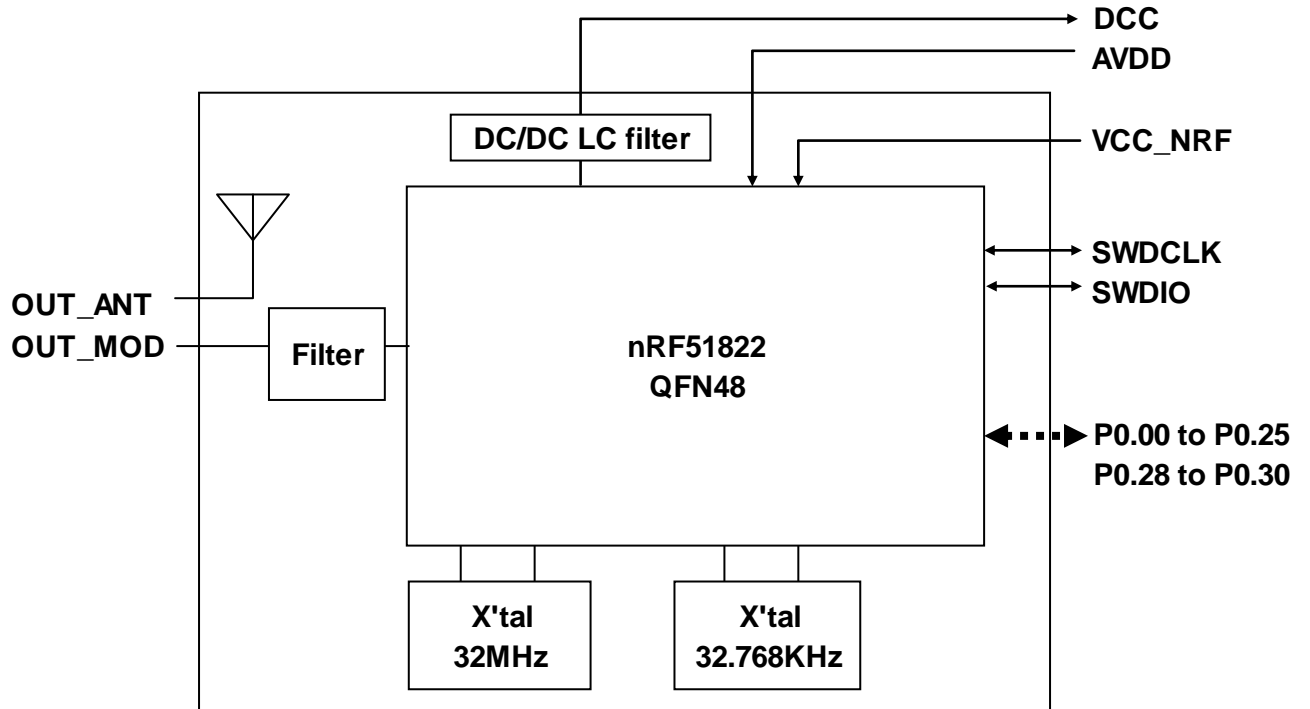

TAIYO YUDEN

EYSGCNAWY-1X

TAIYO YUDEN

Control No. HD-MC-A150104	(2/3)	Control name Circuit Schematic
------------------------------	-------	-----------------------------------

Sample circuits

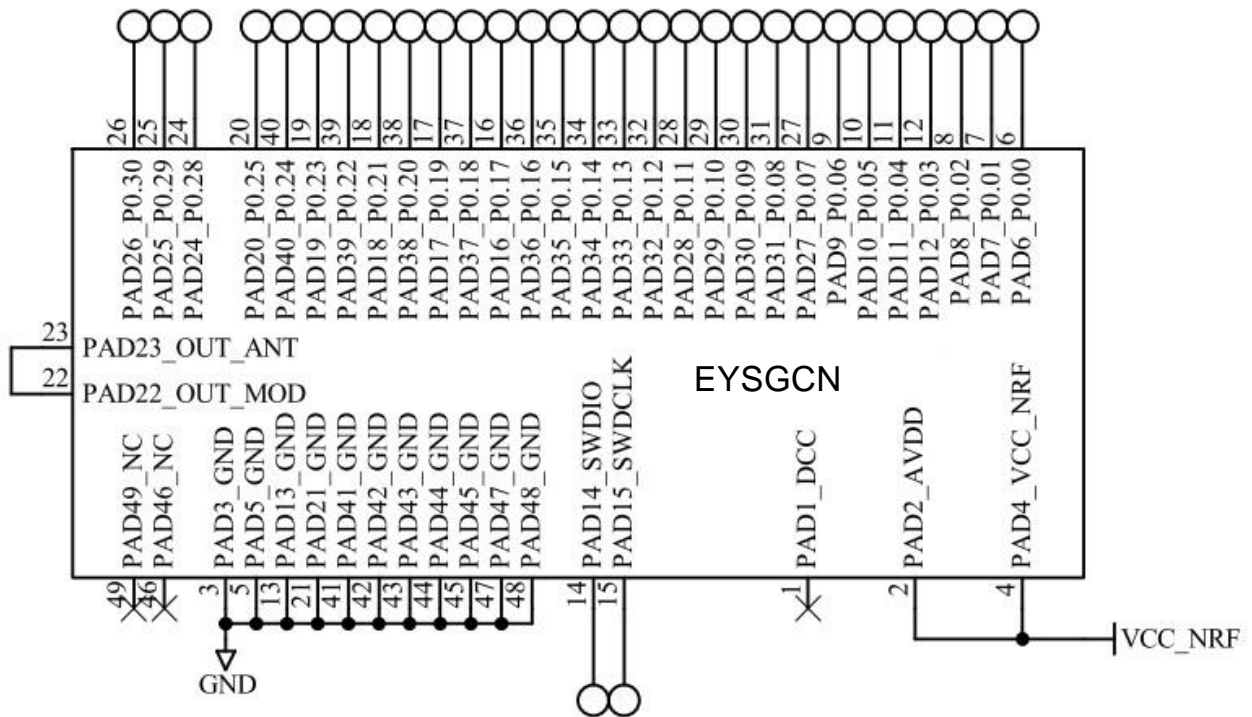

TAIYO YUDEN

EYSGCNAWY-1X

TAIYO YUDEN

Control No. HD-MC-A150104	(3/3)	Control name Circuit Schematic
------------------------------	-------	-----------------------------------

Reference Circuits

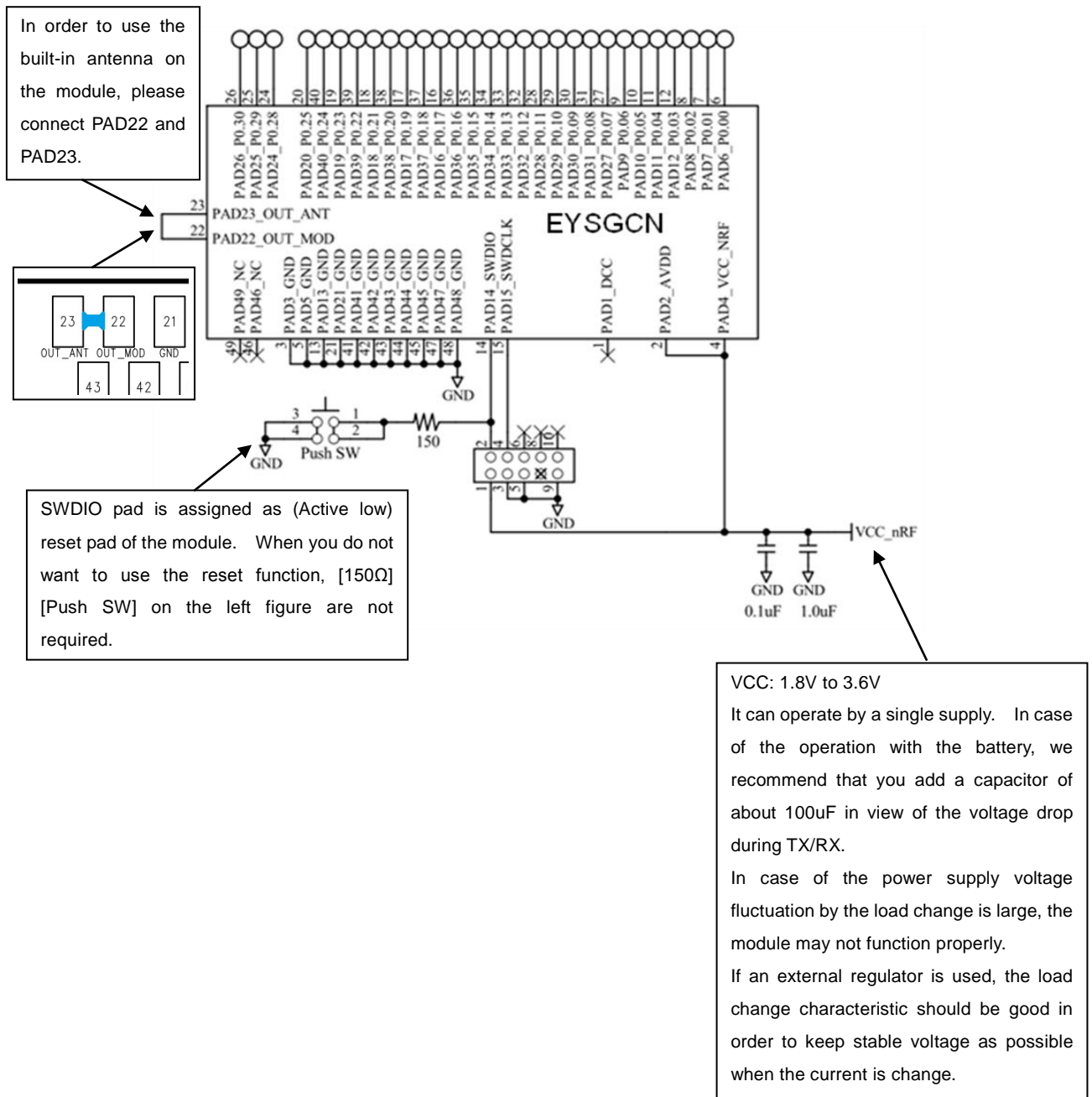

EYSGCNAWY-1X

TAIYO YUDEN

Control No. HD-AD-A150104 (1/3)	Control name Outline/Appearance
---------------------------------------	------------------------------------

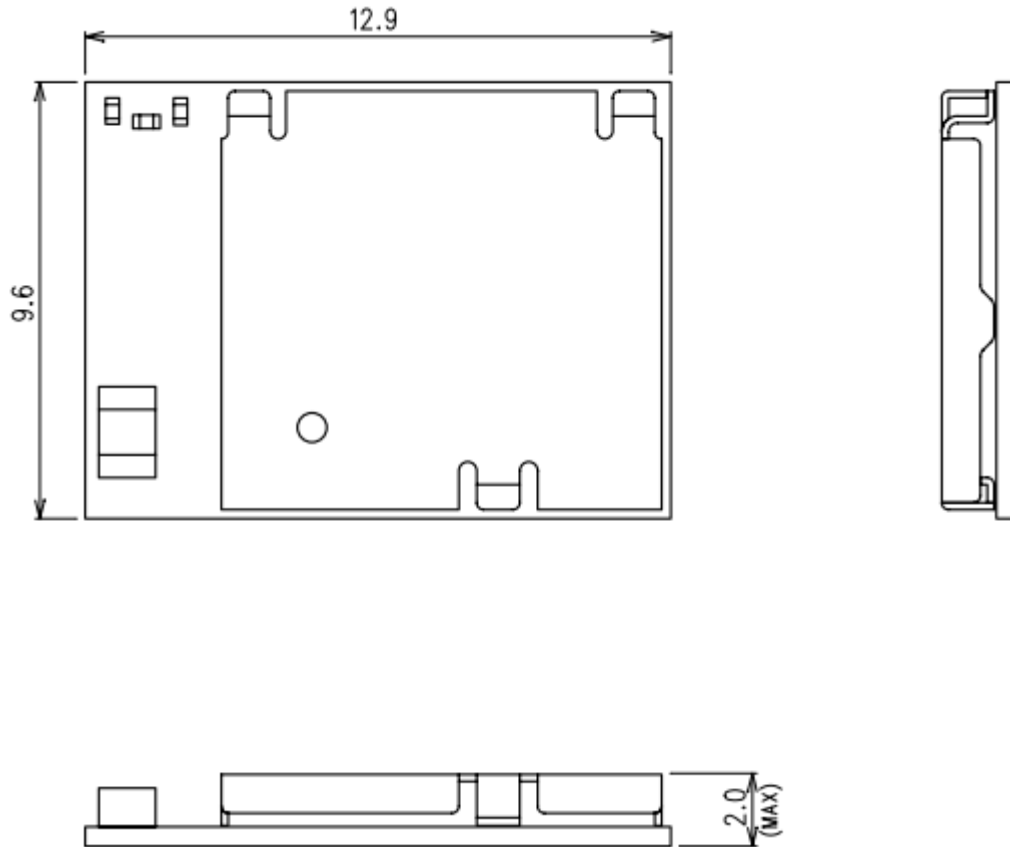

Tolerance: +/- 0.2mm

Unit : (mm)

TAIYO YUDEN

EYSGCNAWY-1X

TAIYO YUDEN

Control No. HD-AD-A150104	(2/3)	Control name Outline/Appearance
------------------------------	-------	------------------------------------

(TOP VIEW)

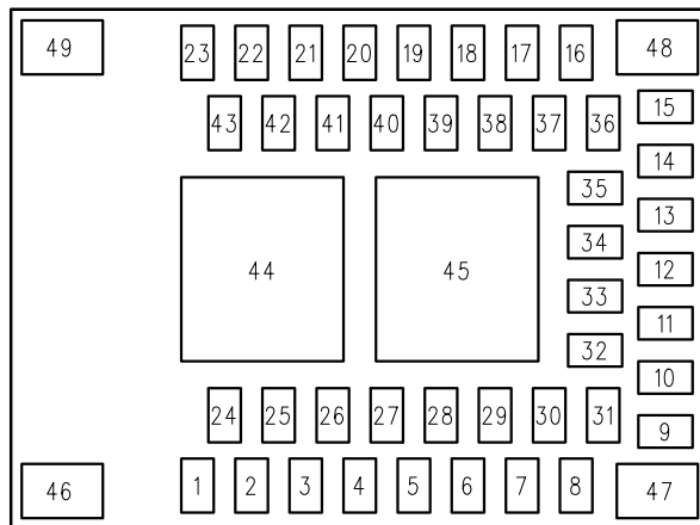
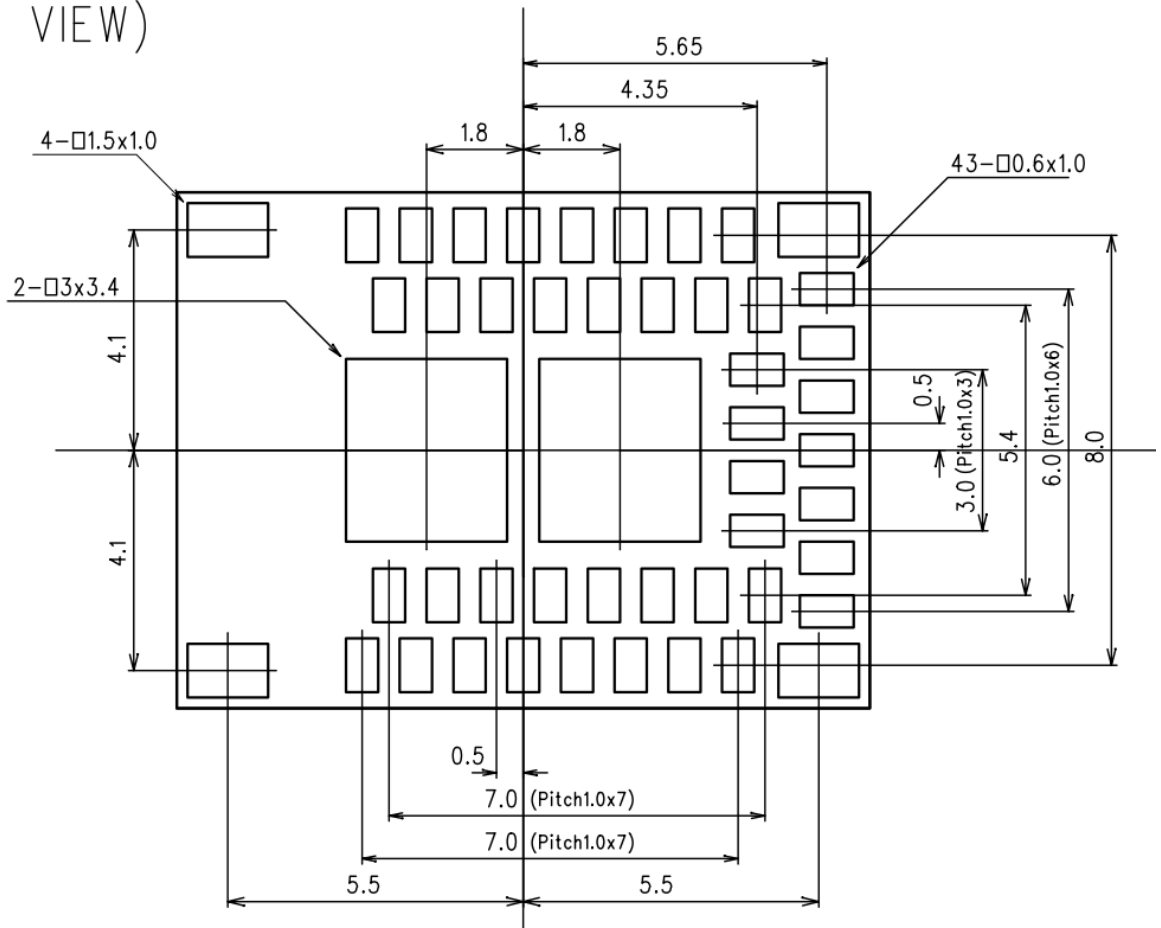

TAIYO YUDEN

EYSGCNAWY-1X

TAIYO YUDEN

Control No.
HD-AD-A150104

(3/3)

Control name
Outline/Appearance**LAND PATTERN EXAMPLE**

(TOP VIEW)

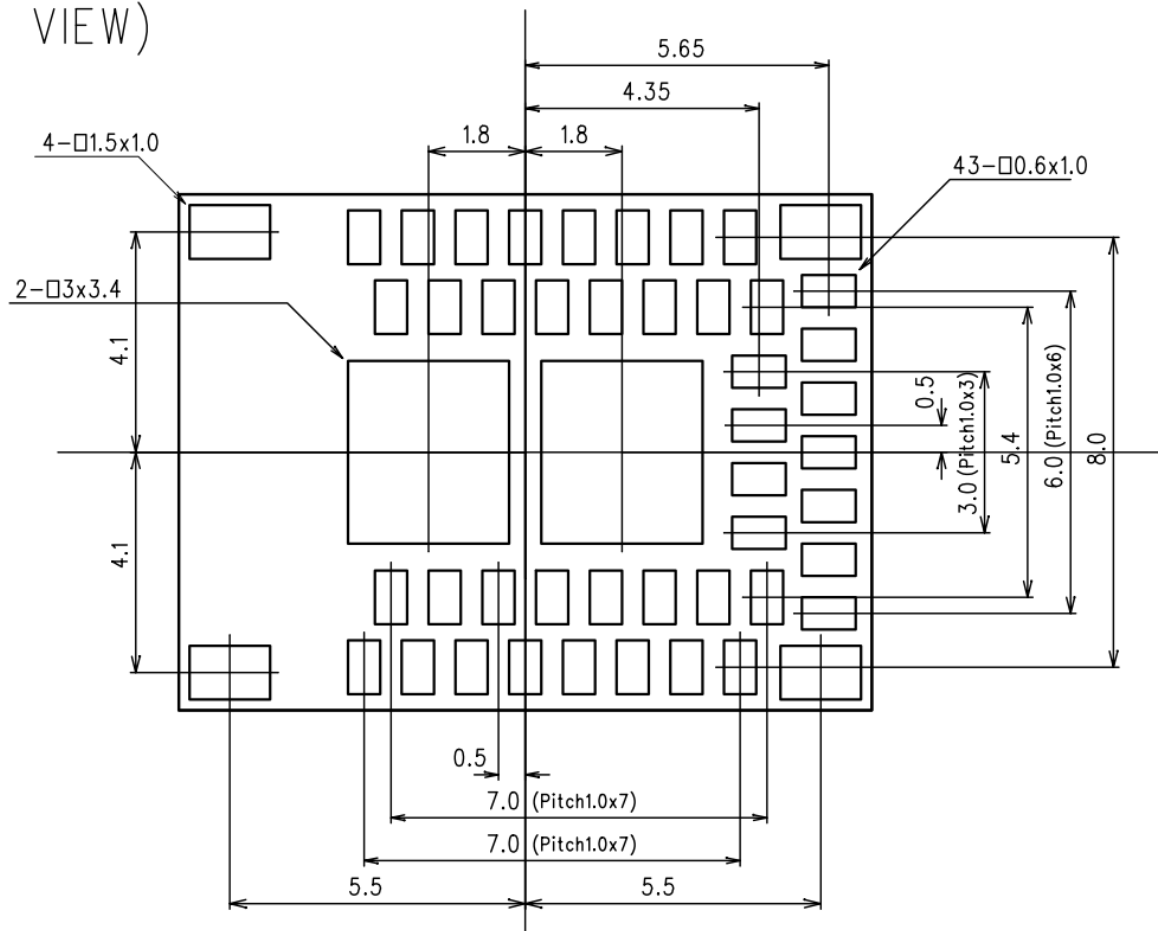
**Recommended metal mask for solder printing**

Pad size	Mask opening
Signal pad 43 – 0.6 x 1.0 mm	0.5 x 0.9 mm
Corner pad 4 – 1.5 x 1.0 mm	1.0 x 0.7 mm
Center pad 2 – 3.0 x 3.4 mm	2.6 x 3.0 mm

The center of each mask opening is same as the pad center.

The metal mask thickness: $t=0.1\text{mm}$

The solder volume should be same by changing the mask opening if different metal mask thickness is used.

TAIYO YUDEN

EYSGCNAWY-1X

TAIYO YUDEN

Control No. HD-BA-A150104	(1/1)	Control name Pin Layout
------------------------------	-------	----------------------------

Pin Descriptions

Pin	Pin name	Pin function	Description
1	DCC	Power	Reserved
2	AVDD	Power	Analog Power supply
3	GND	Ground	Ground (0 V)
4	VCC_NRF	Power	Power supply
5	GND	Ground	Ground (0 V)
6	P0.00	Digital Output	UART_RTS
7	P0.01	Digital Output	UART_TX
8	P0.02	Digital Input	UART_CTS
9	P0.06	Digital Input	Disconnect request / Resume from Power saving mode
10	P0.05	Digital Output	Module active / sleep indicate
11	P0.04	Digital Input	Forced initialize / Request Sleep mode
12	P0.03	Digital Input	UART_RX
13	GND	Ground	Ground (0 V)
14	SWDIO	Digital I/O	System reset (active low). Also HW debug and flash programming I/O
15	SWDCLK	Digital input	HW debug and flash programming I/O
16	P0.17	Digital Input	Connection Parameter change (Peripheral) / Request DFU mode
17	P0.19	Digital Output	State indication of module / DFU indication
18	P0.21	Digital Input	Role switch / Sleep indication of host / Resume from Power saving mode
19	P0.23	Digital Output	Mode indication of module
20	P0.25	Digital Output	Wake up request
21	GND	Ground	Ground (0 V)
22	OUT_MOD	RF In/Out	RF I/O pin. It should be connected to Pin 23 OUT_ANT for normal operation.
23	OUT_ANT	Antenna In/Out	Internal antenna. It should be connected to Pin 22 OUT_MOD for normal operation.
24 to 40	NC	Not Connected	Reserved for future use
41 to 45	GND	Ground	Ground (0 V)
46	NC	Not Connected	Isolated pad on PCB for mechanical stability
47 to 48	GND	Ground	Ground (0 V)
49	NC	Not Connected	Isolated pad on PCB for mechanical stability

TAIYO YUDEN

EYSGCNAWY-1X

TAIYO YUDEN

Control No. HQ-BA-537	(1/2)	Control name Handling Precaution
--------------------------	-------	-------------------------------------

This specification describes desire and conditions especially for mounting.

Desire/Conditions

(1) Environment conditions for use and storage

1. Store the components in an environment of < **40deg-C/90%RH** if they are in a moisture barrier bag packed by TAIYO YUDEN.
2. Keep the factory ambient conditions at < **30deg-C/60%RH**.
3. Store the components in an environment of < **25±5deg-C/10%RH** after the bag is opened.
(The condition is also applied to a stay in the manufacture process).

(2) Conditions for handling of products

Make sure all of the moisture barrier bags have no holes, cracks or damages at receiving. If an abnormality is found on the bag, its moisture level must be checked in accordance with 2 in (2).

Refer to the label on the bag.

1. All of the surface mounting process (reflow process) must be completed **in 12 months** from the bag sea date.
2. Make sure humidity in the bag is less than **10%RH** immediately after open, using a humidity indicator card sealed with the components.
3. **All** of the surface mounting process (reflow process including rework process) must be completed in **168 hours** after the bag is opened (inclusive of any other processes).
4. If any conditions in (1) or condition 2 and 3 in (2) are not met, bake the components in accordance with the conditions at **125deg-C 24hours**
5. As a rule, baking the components in accordance with conditions 4 in (2) shall be once.
6. Since semi-conductors are inside of the components, they must be free from static electricity while handled.(<100V) Use ESD protective floor mats, wrist straps, ESD protective footwear, air ionizers etc. , if necessary.
7. Please make sure that there are lessen mechanical vibration and shock for this module, and do not drop it.
8. Please recognize pads of back side at surface mount.
9. Washing the module is not recommended. If washing cannot be avoided, please test module functionality and performance after thoroughly drying the module.
We cannot be held responsible for any failure due washing the module.
10. Please perform temperature conditions of module at reflow within the limits of the following.
Please give the number of times of reflow as a maximum of 2 times.

TAIYO YUDEN

EYSGCNAWY-1X

TAIYO YUDEN

Control No. HQ-BA-537	(2/2)	Control name Handling Precaution
--------------------------	-------	-------------------------------------

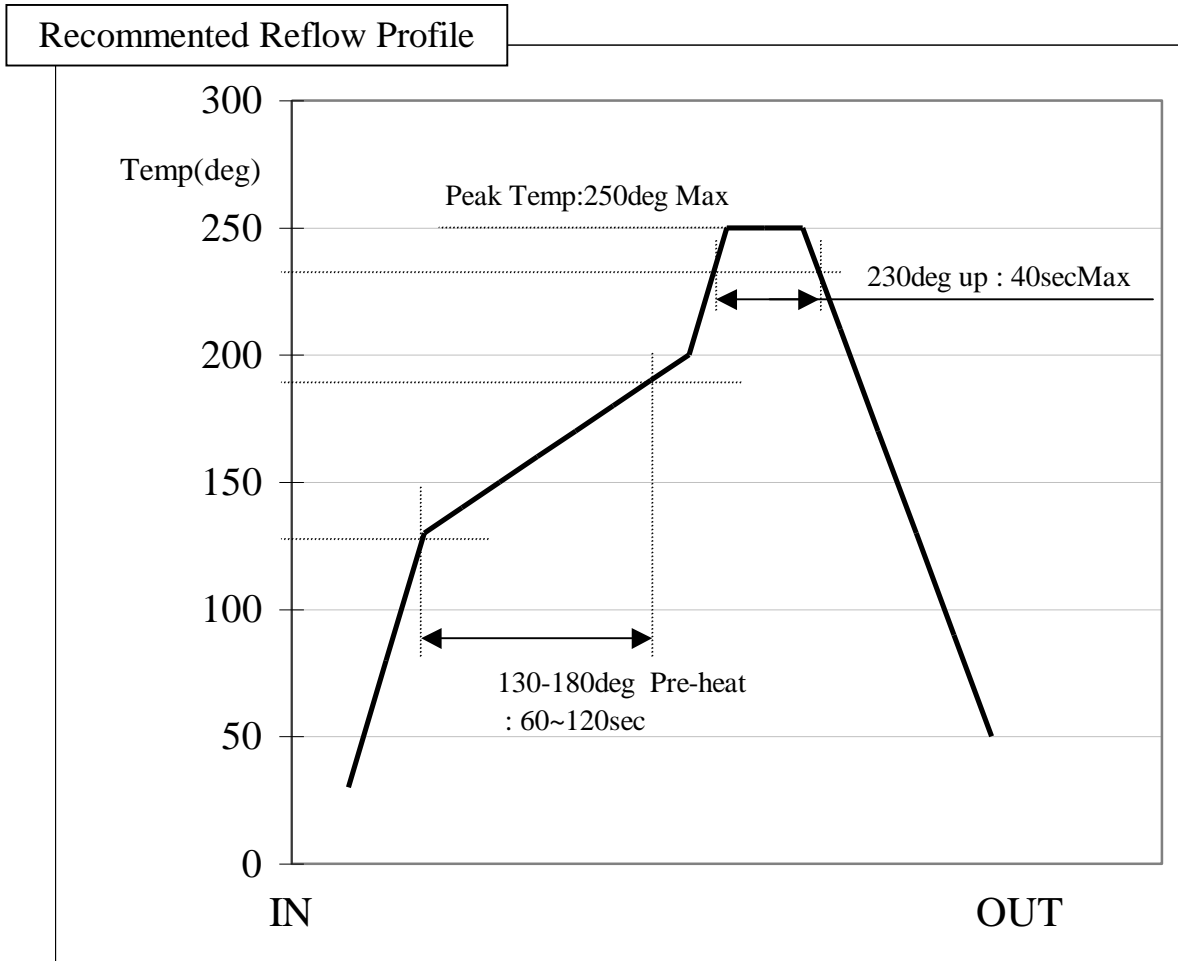

TAIYO YUDEN

EYSGCNAWY-1X

TAIYO YUDEN

Control No. HD-BB-A150104	(1/3)	Control name Packaging Specification
------------------------------	-------	---

Packaging Specification

梱包仕様

(1) Packaging Material 梱包材料

Name 部材名	Outline 概要	Materials 材質	Note 備考
Emboss エンボス	24mm wide - 12mmPitch 24mm幅 - 12mmピッチ	Conductive PS 導電性 PS	
Cover Tape カバーテープ			
Reel リール	φ 330 mm	Conductive PS 導電性 PS	
Desiccant 乾燥剤	30g×1		
Humidity indicator card 湿度インジケータ			
Aluminum moisture barrier bag アルミ防湿袋	420×460(mm)	(AS)PET/AL/NY/PE(AS)	
Label ラベル			
Corrugated cardboard box(Inner) 個装箱	339×351×74(mm)		
Corrugated cardboard box(Outer) 外装箱	369×369×277(mm)		

(2) Packaging Unit

梱包数量

Max 1000 pieces/Reel

Max 3000 pieces/Box(Outer)

(3) Packaging Figure

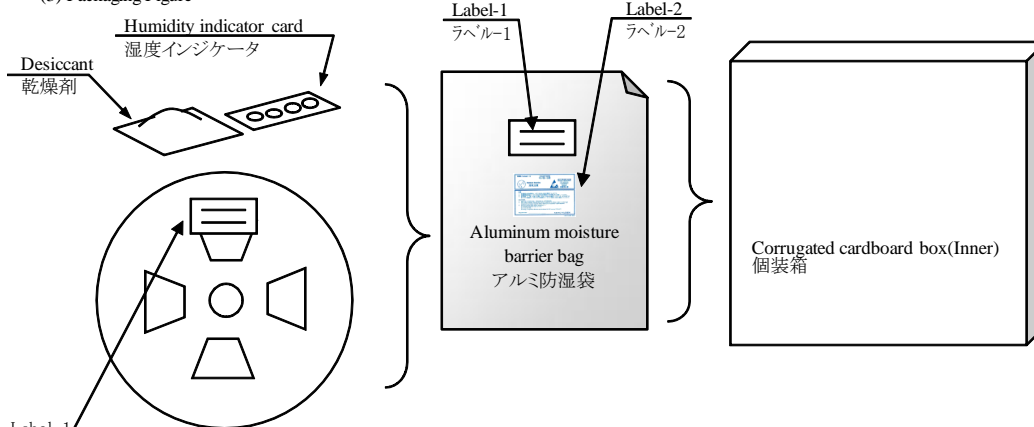

(4) Label

ラベル

Label-1

- COMPANY NAME 御社名
- PURCHASE ORDER 注文番号
- DESCRIPITON 品名
- QUANTITY 数量
- LotNo. ロット番号

Label-2

- CAUTION LABEL
注意ラベル
- MSL Level3

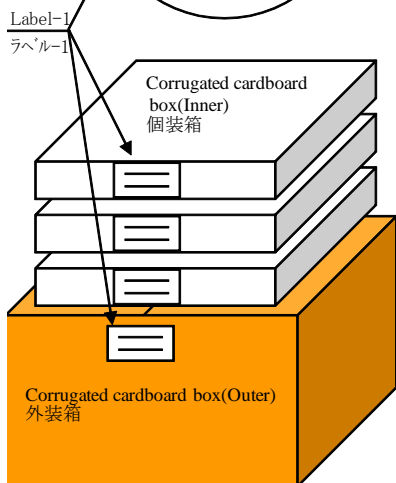

TAIYO YUDEN

EYSGCNAWY-1X

TAIYO YUDEN

Control No. HD-BB-A150104	(2/3)	Control name Packaging Specification
------------------------------	-------	---

Tape specification
テーピング仕様

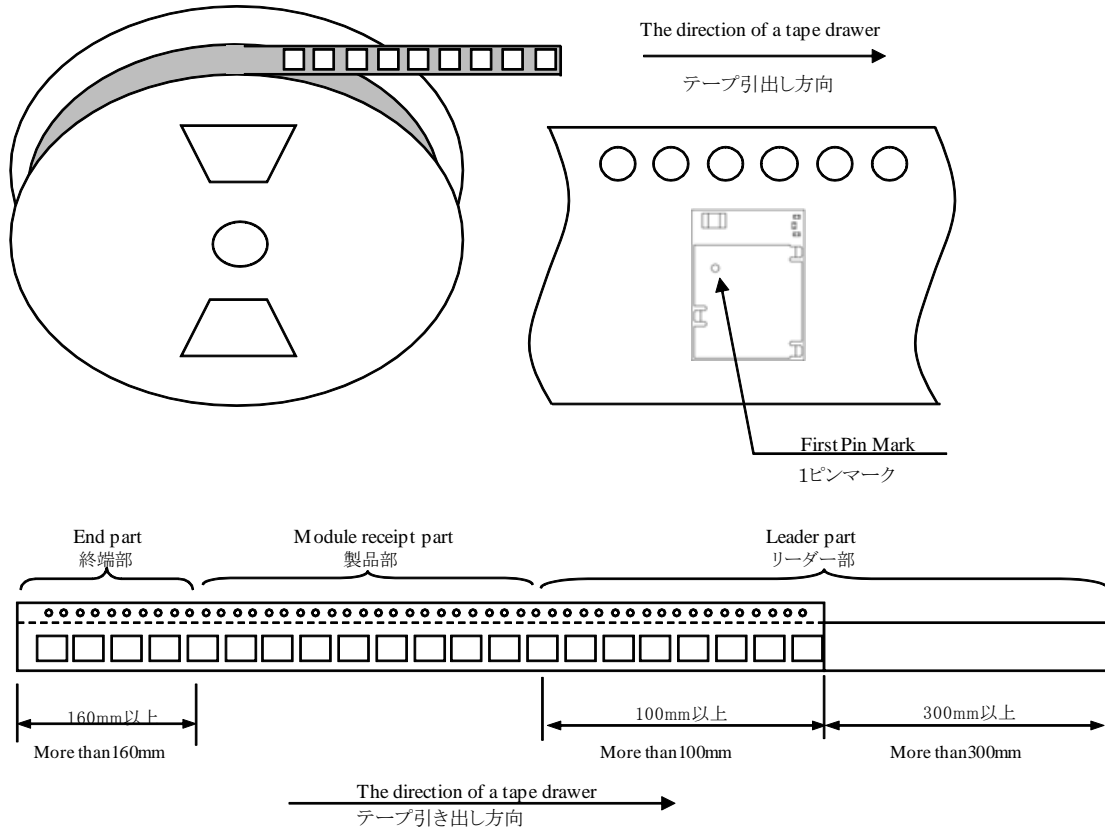

キャリアエンボス図面

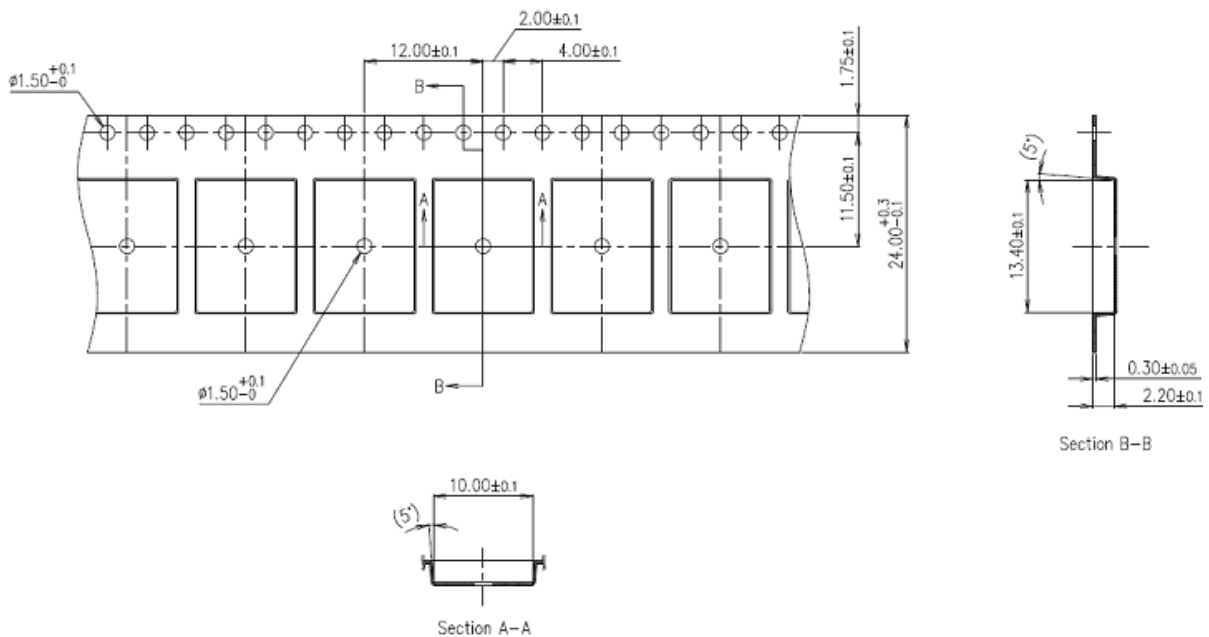

TAIYO YUDEN

EYSGCNAWY-1X

TAIYO YUDEN

Control No.
HD-BB-A150104

(3/3)

Control name
Packaging Specification

Reel specification

リール仕様

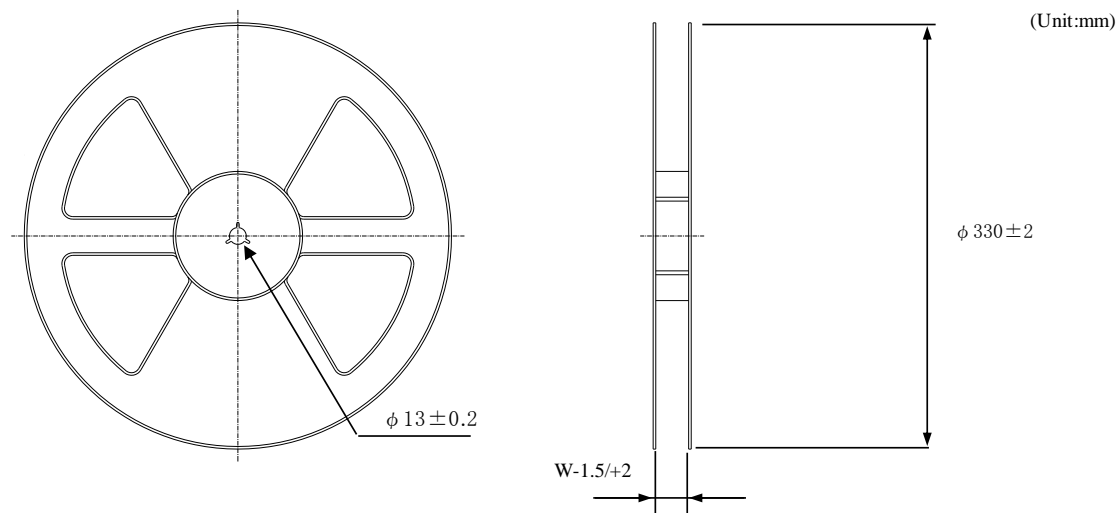

Tape wide	8mm	12mm	16mm	24mm	32mm	44mm
W	9.4mm	13.4mm	17.4mm	25.4mm	33.4mm	45.4mm

Taping performance

テーピング性能

Both of an embossing tape top cover tape bear this, when the power of 10N is applied in the direction of a drawer.

- ・エンボステープ、トップカバーテープともに、引き出し方向に10Nの力を加えた場合に、これに耐えること。

The exfoliation adhesion of a top cover tape is the intensity of 0.1~1.3N.

(The angle to pull is 165~180 degrees. The speed to pull is 300 mm/min.)

- ・トップカバーテープの剥離強度は、角度165~180度に保ち、300mm/minのスピードでトップカバーテープを引っ張ったとき、0.1~1.3Nとする。

Note

備考

Lack of the parts in 1 reel is with two or less pieces.

1リール中の部品の欠落は2個までとします。(ラベル表示数量と梱包数は同じです。欠落とはテープ内でのモジュール抜けが2個まで許容させていただくという意味になります。)

MSL Level 3 Under control

MSL はレベル3 で管理しています。

TAIYO YUDEN

EYSGCNAWY-1X

TAIYO YUDEN

Control No. (1/3)	Control name Antenna application note
--------------------------	--

Keep-out area

In order to keep the antenna performance on the module, please do not place any components, ground of main board, signal line, conductive plating in Keep-out area except for the lands (46pin, 49pin). The purpose of lands (46pin, 49pin) are for mounting module. Please place lands only in the keep-out area. (Please do not connect pattern line to those lands.)

Keep-out area will be applicable in all layers of the customer's substrate also.

Please consider on the occasion of pattern design.

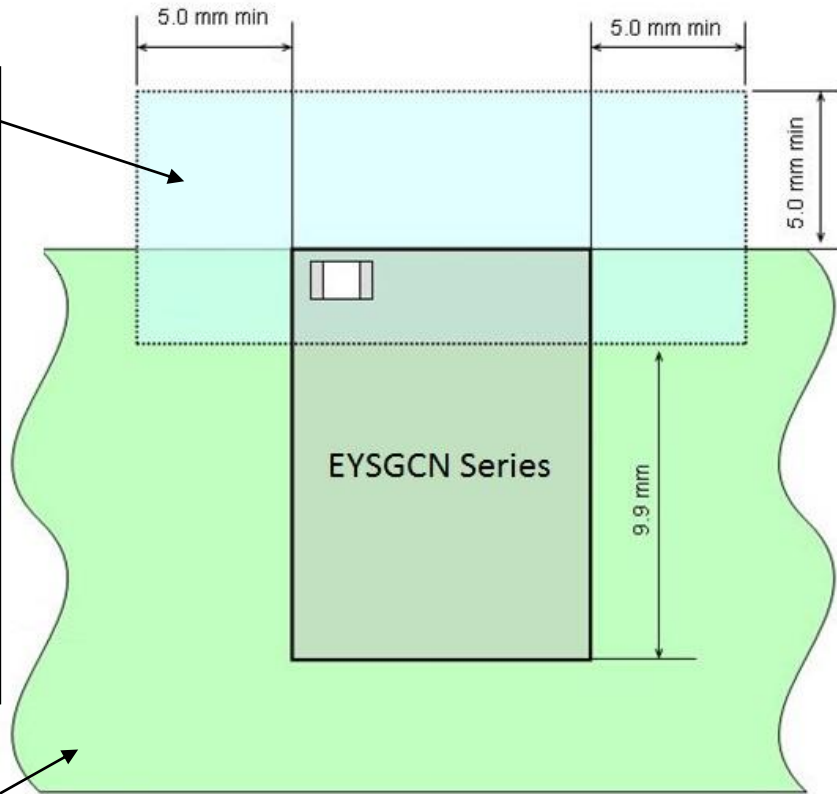

Top View

Main board of the customer's product.

EYSGCNAWY-1X

TAIYO YUDEN

Control No. (2/3)	Control name Antenna application note
--------------------------	--

Recommended arrangement of the module

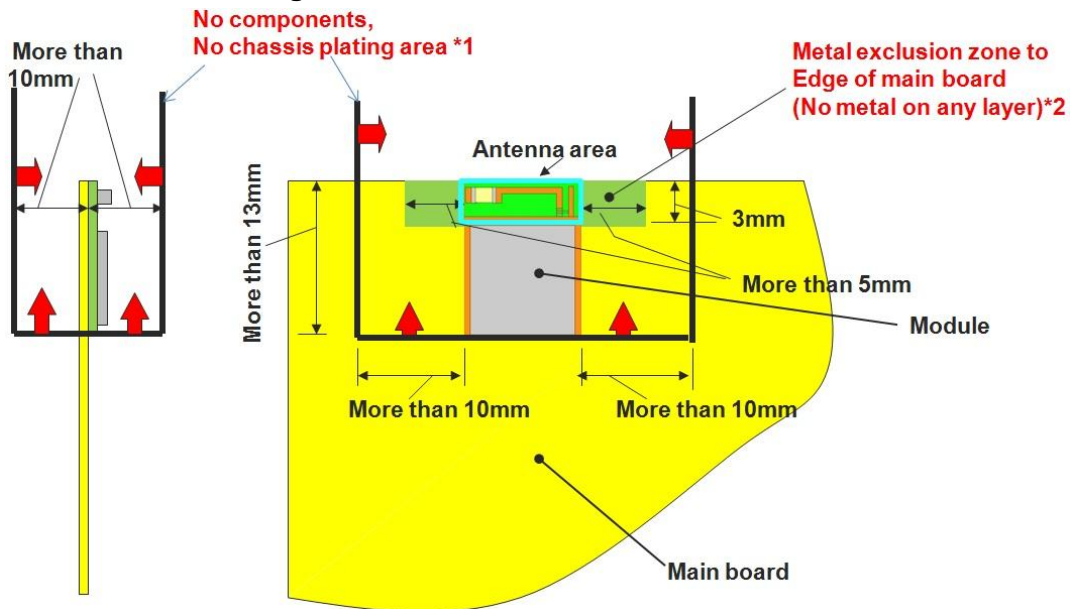

*1 Please do not place any board, signal line and metal chassis as possible except main board.

Mounting the components in *1 area on the main board is allowed in keeping with next item *2.

*2 This area is routing prohibited area on the main board. Please do not place Copper on any layer. Please remain FR-4 dielectric material. The antenna is tuned with the FR-4.

Example layout on main board



TAIYO YUDEN

EYSGCNAWY-1X

TAIYO YUDEN

Control No. (3/3)	Control name Antenna application note
--------------------------	--

Antenna arrangement near resin

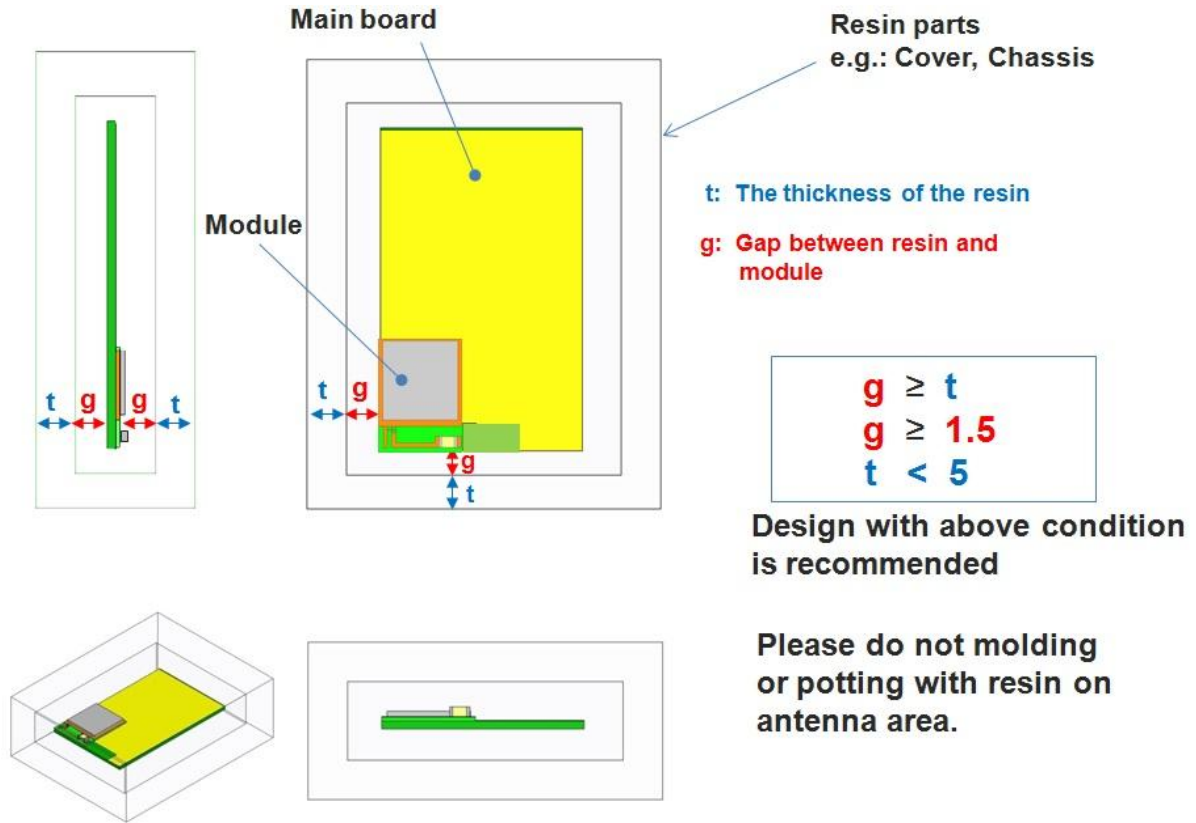

EYSGCNAWY-1X

TAIYO YUDEN

Control No. (1/1)	Control name Design guide
----------------------	------------------------------

1. Power Up Sequence

VCC_NRF power supply rise time (0V to 1.8V) must not exceed 100ms.

2. Recommended Power Circuit

VCC_NRF is the main power supply (1.8 – 3.6V) for this module. The supply voltage range of VCC_NRF is 1.8V to 3.6V in LDO mode. In case of the power supply voltage fluctuation by the load change is large, the module may not function properly. If an external regulator is used, the load change characteristic should be good in order to keep stable voltage as possible when the current is change.

3. Battery operation

When using a small battery (e.g. CR2032), a large capacitor (e.g.100uF low leakage capacitor) should be placed near the battery. This will reduce the voltage drop especially when the module is operated at low temperatures

4. Pattern Design Guide

4-1. Power Supply System

Power supply bypass capacitors should be placed close to the VCC_NRF pin of the module. The VCC_NRF trace should be greater than 0.5mm and a bigger a via diameter is recommended.

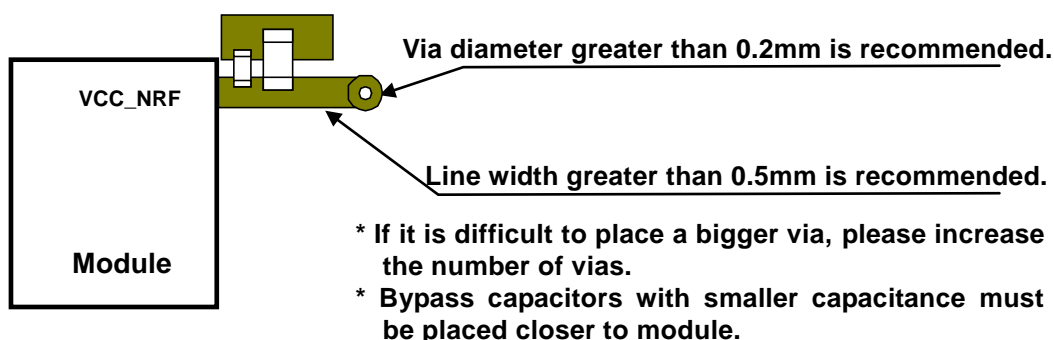

4-2. Bypass Capacitor Layout

A parallel combination of a small capacitance (about 10pF) and a large capacitance (1uF to 10uF) is recommended for bypass capacitors. The GND of the bypass capacitor should be placed close to an adjacent module GND to ensure the shortest closed loop.

4-3. GND Pattern

Power supply bypass capacitor GND should be placed in proximity of module GND. Wide GND area must be provided to ensure isolation for each layer.

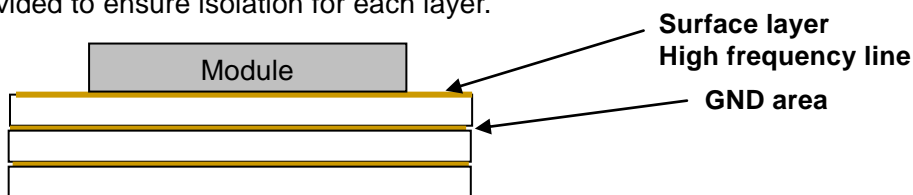

GND pattern of each layer should be connected to GND area with large number of via.

EYSGCNAWY-1X

TAIYO YUDEN

Revision History

Version	Date	Description
1.0.0	2015/09/03	First release.

EYSGCNAWY-1X

TAIYO YUDEN

Copyright Information:

- *Bluetooth*[®] Smart module Software -

This software is owned by TAIYO YUDEN CO., LTD.

You and your company shall conform following:

- (1) The software image may not be made a copy from TAIYO YUDEN CO., LTD's module.
- (2) The software image provided by Taiyo Yuden must not be loaded to another vendor's module or chipset, and can be copied only for backup.
- (3) The software image may not be provided to anyone.
- (4) The software image may not be analyzed by reverse engineering, decompile, and disassemble.

TAIYO YUDEN CO., LTD. is not responsible for any damage caused by this software.

Copyright Year 2015-

Firmware Version is Ver. 4.0.0

There is a possibility of changing a software specification.

TAIYO YUDEN

Contents

1. OVERVIEW	30
2. BASIC SOFTWARE STATE DIAGRAM.....	31
3. RESPONSE EVENT SYNTAX.....	32
4. RESPONSE EVENT SYNTAX.....	32
5. ERROR CODES.....	33
6. CONFIGURATION	34
7. MESSAGE SEQUENCE CHART	35
7.1 POWER ON (CENTRAL)	35
7.2 POWER ON (PERIPHERAL)	35
7.3 CONNECT (CENTRAL).....	36
7.4 CONNECT (PERIPHERAL).....	36
7.5 SENDING & RECEIVING DATA OVER A CONNECTED LINK.....	37
7.6 CONNECTION PARAMETER UPDATE	38
7.7 DISCONNECT REQUEST	38
8. GPIO STATE AND CONTROL	39
8.1 SCANNING	40
8.2 ADVERTISING	40
8.3 CONNECT	40
8.4 DISCONNECT & STANDBY.....	40
8.5 FORCED INITIALIZE.....	40
8.6 SLEEP MODE REQUEST AND INDICATE	41
9. SERVICE	42
10. UART CONFIGURATION	42
11. SWD (SERIAL WIRE DEBUG).....	42
12. HOST WAKE-UP SEQUENCE	43
13. DTM (DIRECT TEST MODE)	44
13.1 ENTER DTM AND EXIT DTM (ONE-TIME)	44
13.2 DTM COMMANDS/EVENTS	44
14. GPIO CHECK.....	45
15. SLEEP MODE (SYSTEM ON).....	46
15.1 ENTER SLEEP MODE	46
15.2 EXIT SLEEP MODE	46
16. POWER SAVING MODE (SYSTEM OFF)	47
16.1 EXIT POWER SAVE	47
17. DEVICE FIRMWARE UPDATES (DFU).....	48
18. NOTICES.....	49

EYSGCNAWY-1X

TAIYO YUDEN

1. Overview

This specification is for module based on TAIYO YUDEN original service. This specification will only define supporting point-to-point connections.

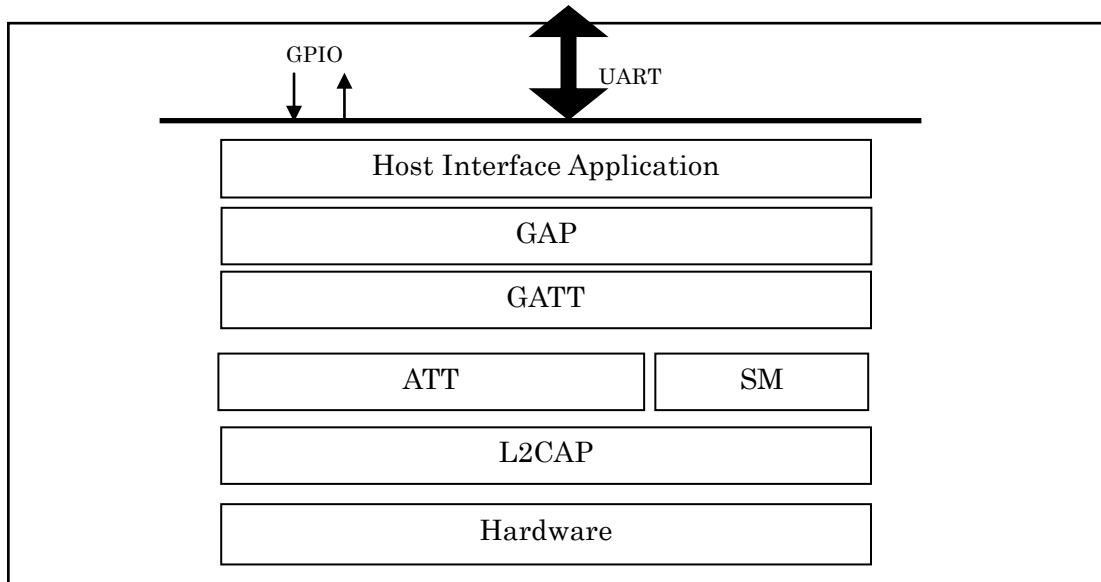

Software Block Diagram

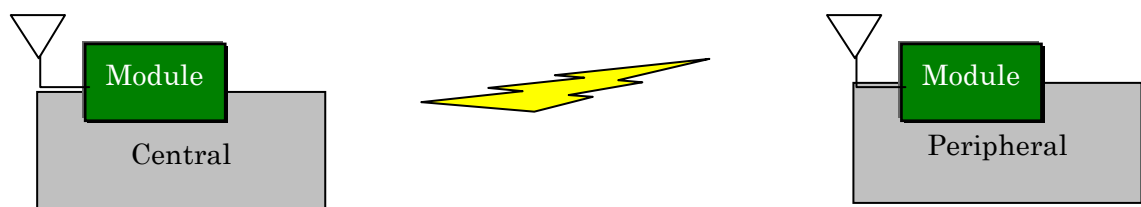

Usage Model

*** We support only the connection between TYSA-B Lite Central and TYSA-B Lite Peripheral.
TYSA-B Lite supports only one-to-one connection.**

TAIYO YUDEN

2. Basic software state diagram

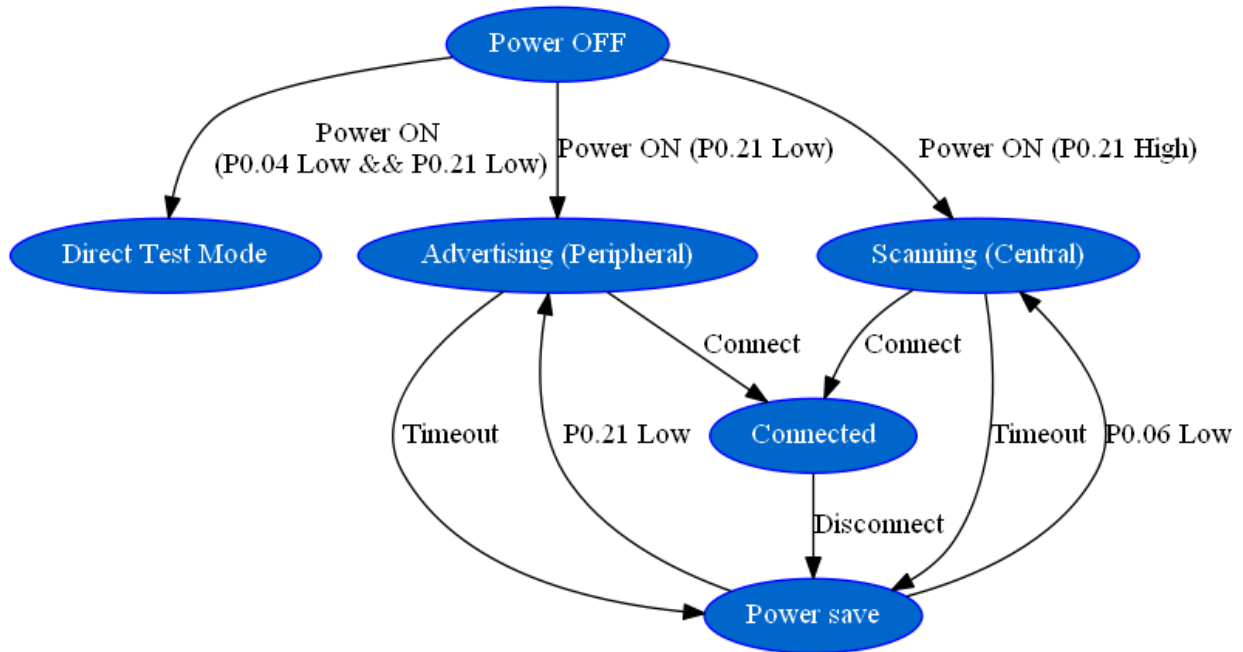

- **Power OFF:**
Power OFF
When Power ON,
P0.21 Low : start as Peripheral
P0.21 High : start as Central
- **Advertising / Scanning:**
Search for 60 second
- **Connected**
Send and receive data
- **Power save**
SYSTEM OFF
Resume with P0.21 Low : start as Peripheral
Resume with P0.06 Low : start as Central
- **Direct Test mode**
RF PHY testing of *Bluetooth*® low energy devices.

EYSGCNAWY-1X

TAIYO YUDEN

3. Response Event Syntax

Response event which host receives are started with <CR><LF> and ended <CR><LF>.

Response Event:

<CR><LF>{*event characters*}[*Parameter1Parameter2::Parameter(N)*]<CR><LF>

4. Response Event Syntax

Response Events	Function	Parameters
ACK	Successful	
NAK##	Failed	Failed Reason – See Error Section (5.) for further details.
CON	Connection successful	Established Remote BD_ADDR
DCO	Disconnect	
PAS	Pairing Success	
SCT	Scanning Timeout (Central)	
INT	Connection Interval (Central)	<u>Parameter0</u> : Max Connection Interval <u>Parameter1</u> : Min Connection Interval
ADT	Advertising Timeout (Peripheral)	
SDC	Service Discovery Complete (Peripheral)	
DSR	Disable Service (Peripheral)	

TAIYO YUDEN

EYSGCNAWY-1X

TAIYO YUDEN

5. Error Codes

#	Error Name	Program Logic Cause / Action taken by Host
-1	Unknown Error	There is the possibility that the hardware is out of order.
00	Command Not Recognized	It confirms whether or not the command is correct. TYS-A-B Lite doesn't support any command. Wait for connection success. ("CON" response)
03	Send Data Error	It failed to send data over BLE.
04	UART Buffer full (buffer size : 512byte)	Wait until data is sent over BLE. (in CONNECTED state) Buffer is cleared and input command again. (in other state)
05	Connection Fail (Central Only)	Please try again. If bond information exists, delete it and try again.
06	Device Full	Flash block for storing pairing information is full. (Max 7) To store new device information, delete with forced initialize (8.5).
07	Pairing Failed	Please try again. If bond information exists, delete with forced initialize (8.5) and try again.
08	FLASH access error	Please run forced initialize (8.5).
11	Connection Parameter Error	It confirms connection parameter. Please run forced initialize (8.5).
21	Advertising Parameter Error (Peripheral Only)	It confirms advertising data and parameter. Please run forced initialize (8.5).
31	Scanning Parameter Error	It confirms scanning parameter. Please run forced initialize (8.5).

EYSGCNAWY-1X

TAIYO YUDEN

6. Configuration**Central**

Item	Value
Scanning Timeout	60 sec
Scanning Interval	100 msec
Scan window	100 msec
Connection Interval	Minimum : 7.5ms Maximum : 7.5ms
Supervision Timeout	5000ms
Slave Latency	0
TX Power	4 dBm
Target Device Name	TYSA-B Lite

Peripheral

Item	Value
Advertising Timeout	60 sec
Advertising Interval	40 msec
Connection Interval	Minimum : 200ms Maximum : 200ms
Supervision Timeout	5000 msec
Slave Latency	0
Security	None
TX Power	4 dBm
Local Device Name	TYSA-B Lite

EYSGCNAWY-1X

TAIYO YUDEN

7. Message Sequence Chart

7.1 Power On (Central)

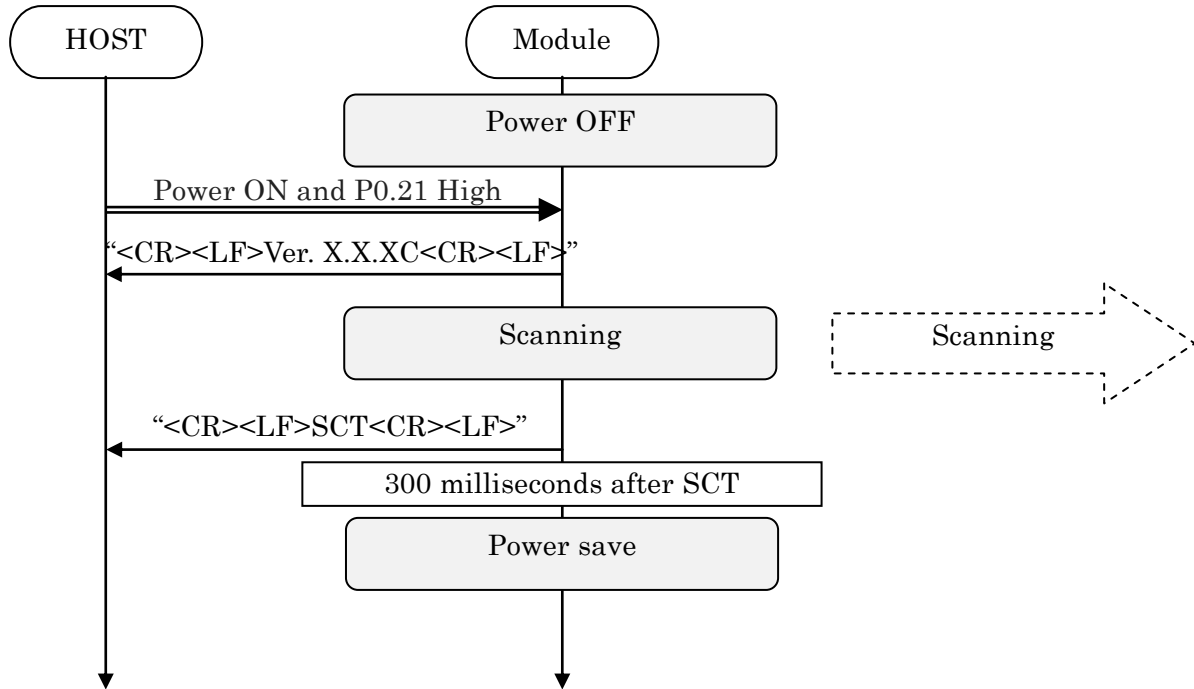

7.2 Power On (Peripheral)

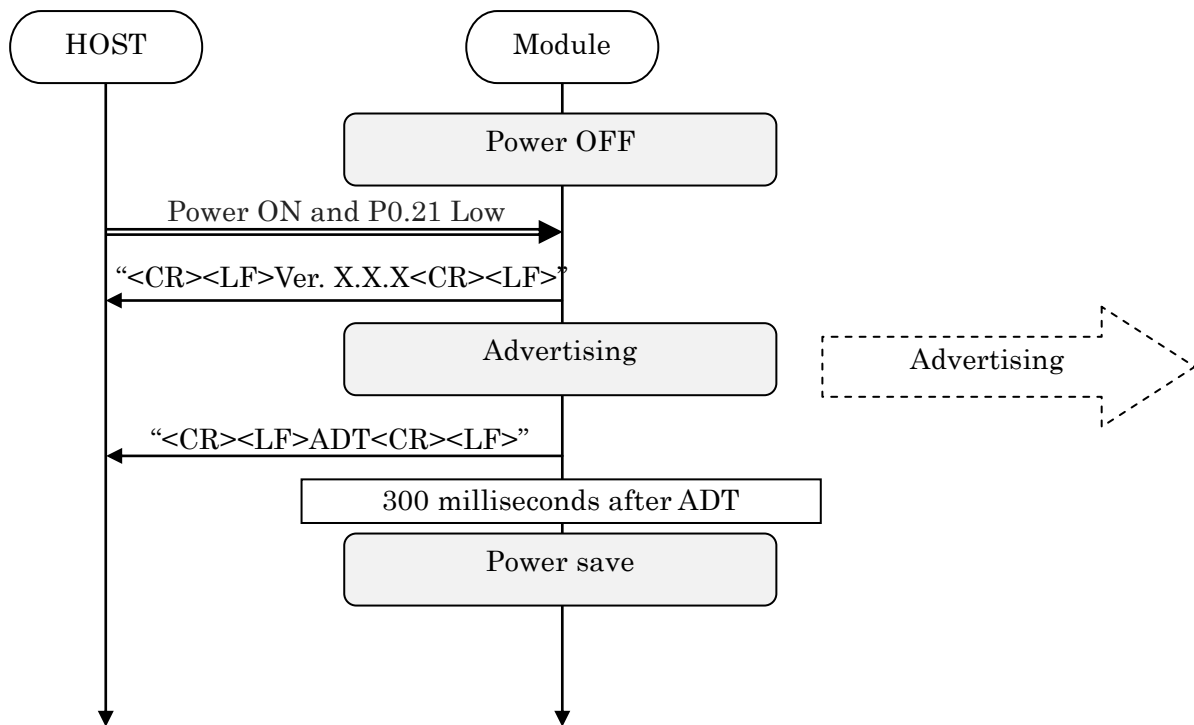

TAIYO YUDEN

7.3 Connect (Central)

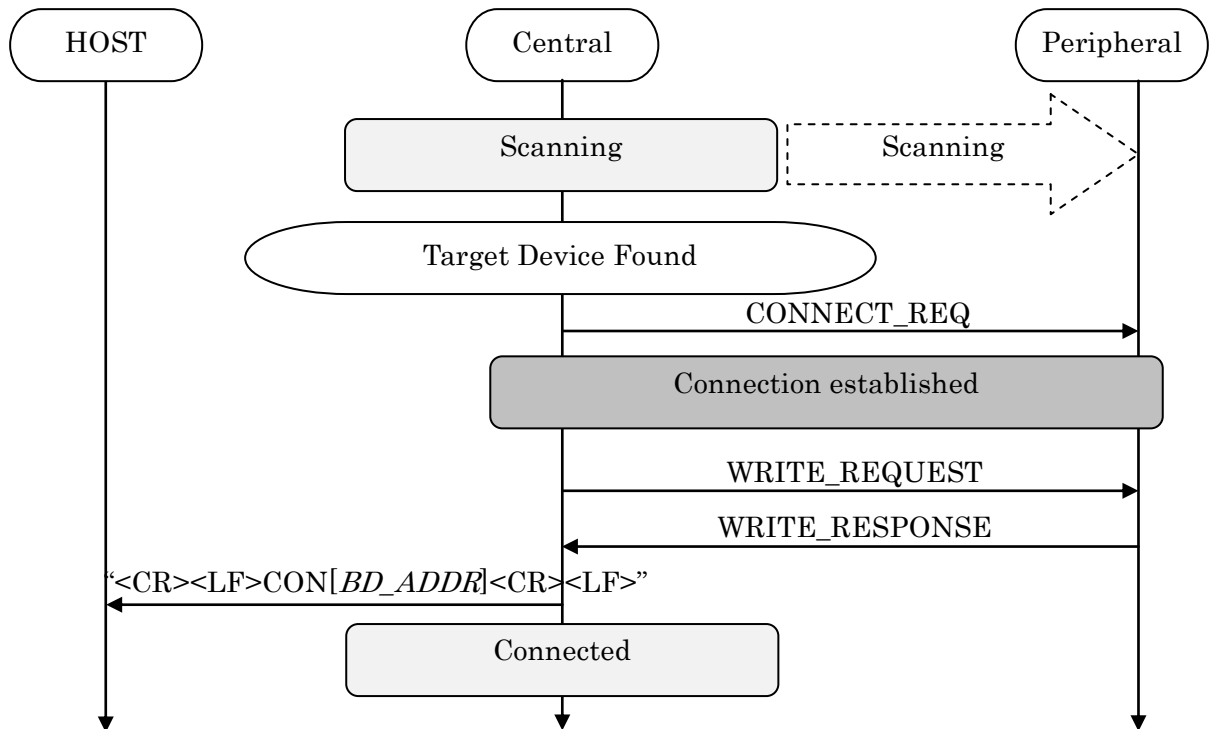

7.4 Connect (Peripheral)

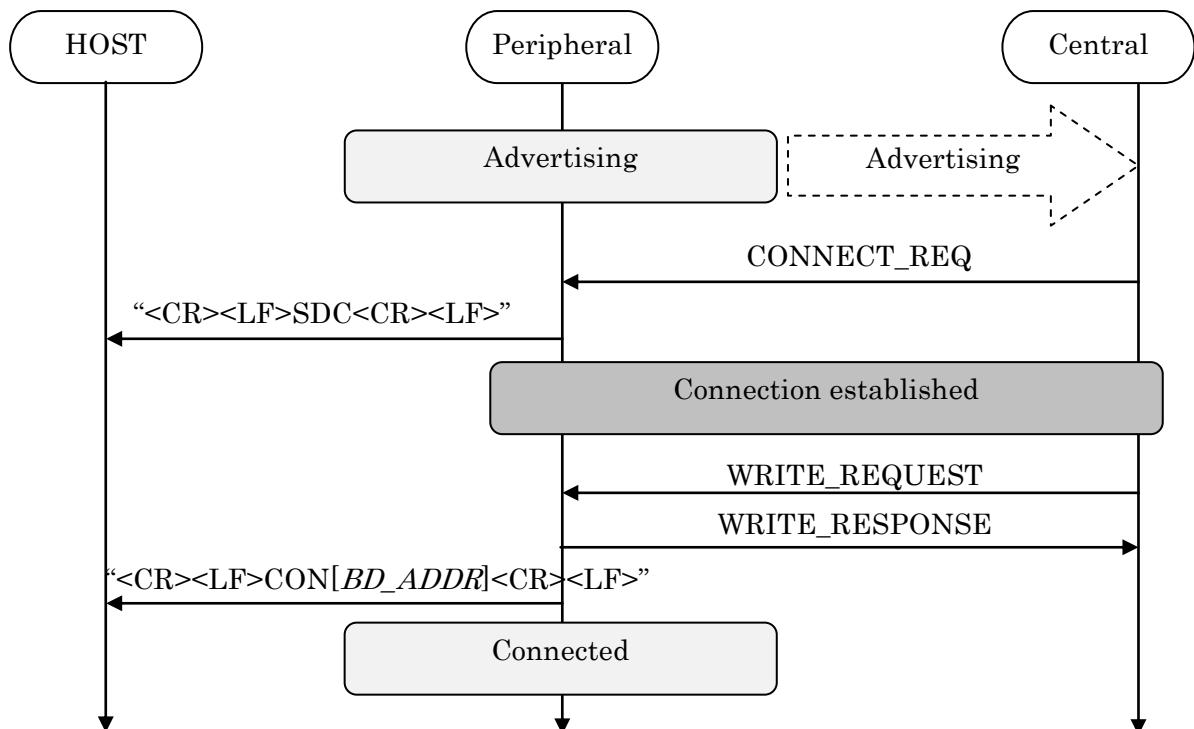

7.5 Sending & Receiving Data over a connected Link

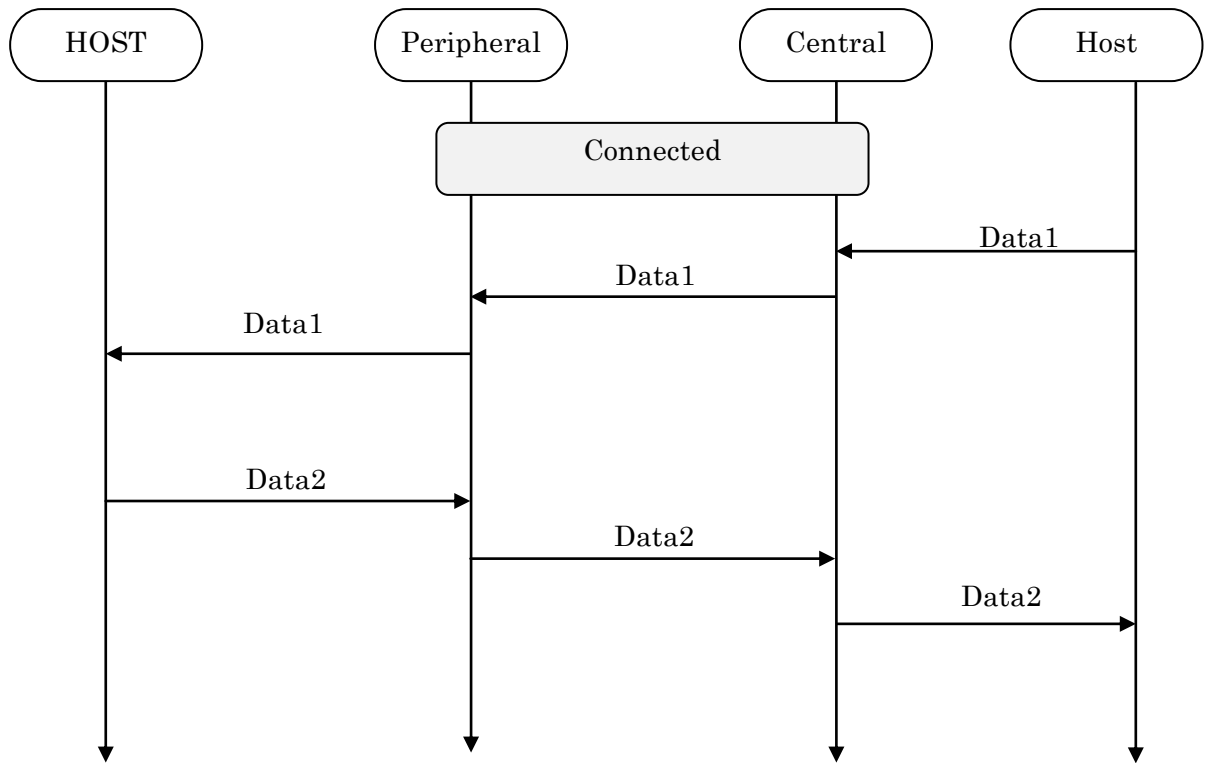

Max send a packet data size = 20bytes
Max receive a packet data size = 20bytes

7.6 Connection Parameter update

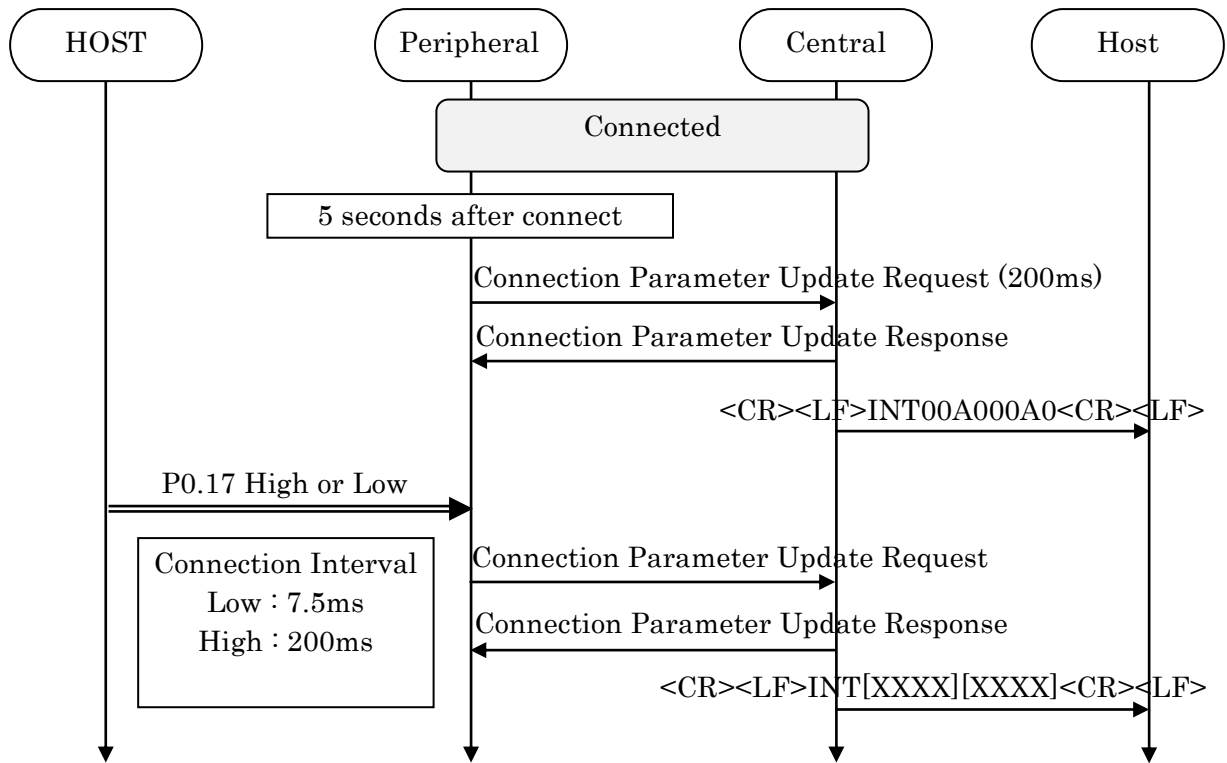

7.7 Disconnect Request

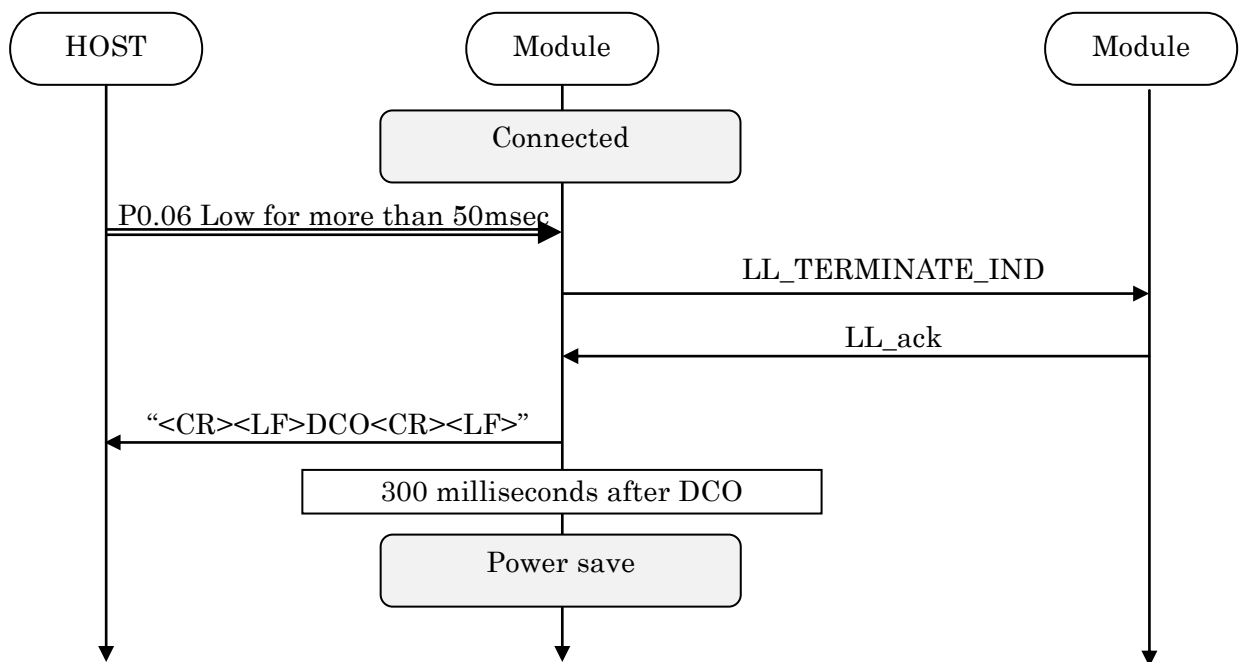

EYSGCNAWY-1X

TAIYO YUDEN

8. GPIO state and control

Pin Name	Input / Output	Description
P0.04	Input	Forced initialize
		Request Sleep mode
P0.17	Input	Connection Parameter change (Peripheral)
		Request DFU mode
P0.05	Output	Module active/sleep indicate
P0.19	Output	State indication of module
		DFU indication
P0.06	Input	Disconnect request
		Resume from Power saving mode
P0.21	Input	Role switch
		Sleep indication of host
		Resume from Power saving mode
P0.25	Output	Wake up request
P0.23	Output	Mode indication of module

Note**P0.17**

In case of setting the Connection Interval to 7.5ms using this pin, the current is increased around 250uA extra during this pin with GND level.

P0.21

After setting to peripheral mode by this pin, do not keep this pin to GND level.
The current is increased around 250uA extra.

EYSGCNAWY-1X

TAIYO YUDEN

8.1 Scanning

P0.19

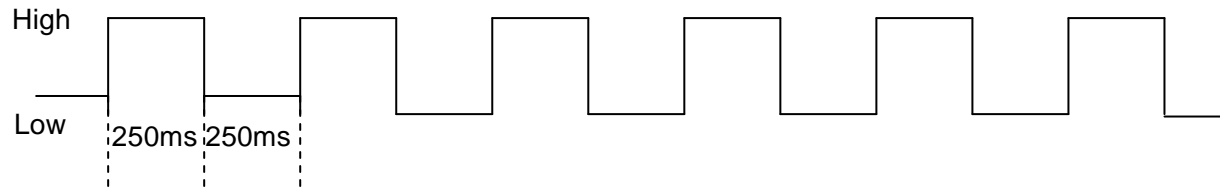

P0.23 Low

8.2 Advertising

P0.19

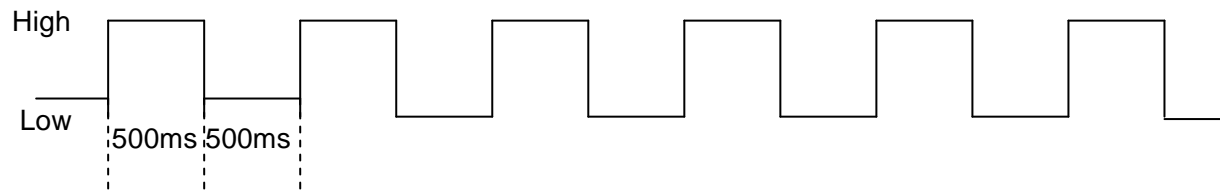

P0.23 Low

8.3 Connect

P0.19 High

P0.23 High

8.4 Disconnect & Standby

P0.19 Low

P0.23 Low

8.5 Forced initialize

All user setting of the module return to a default value when make P0.04 Low at module startup.
After P0.04 Low, H/W reset or power restart is necessary.

EYSGCNAWY-1X

TAIYO YUDEN

8.6 Sleep mode request and indicate

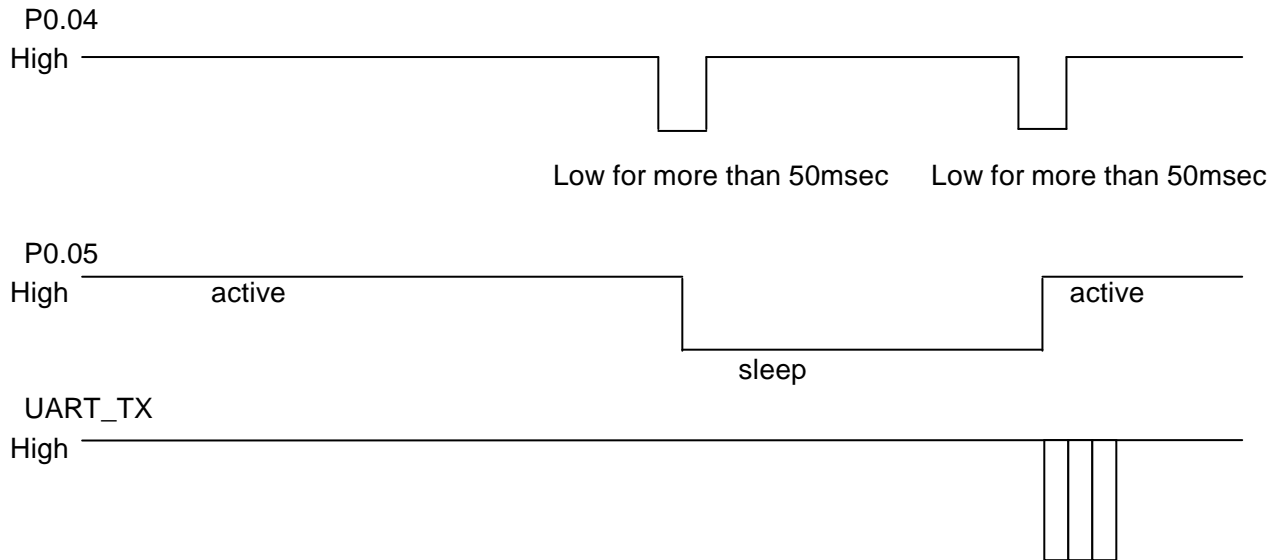

*** Buffer size : 128byte** If the buffer is full, further data received is discarded without any events.

EYSGCNAWY-1X

TAIYO YUDEN

9. Service

Primary Service

TAIYO YUDEN Original Service UUID :

0x442F1570-8A00-9A28-CBE1-E1D4212D53EB

Characteristic

TAIYO YUDEN Original Characteristic UUID :

0x442F1571-8A00-9A28-CBE1-E1D4212D53EB (Read, Notify)

TAIYO YUDEN Original Characteristic UUID :

0x442F1572-8A00-9A28-CBE1-E1D4212D53EB (Write, Write no response, Notify)

*** GATT Server is implemented in TYSA-B Lite Peripheral role.**

10. UART configuration

RX_PIN : P0.03

TX_PIN : P0.01

CTS_PIN : P0.02

RTS_PIN : P0.00

Baud rate : 38400 bps

Data : 8 bit

Parity : none

Stop : 1 bit

Hardware flow control : Enabled (In case of DTM, flow control is disabled)

11. SWD (Serial Wire Debug)

SWDIO :

SWDCLK :

These pins are for FW debug and flash programming I/O.

We recommend your company set up these pins for rewriting the firmware.

12. Host wake-up sequence

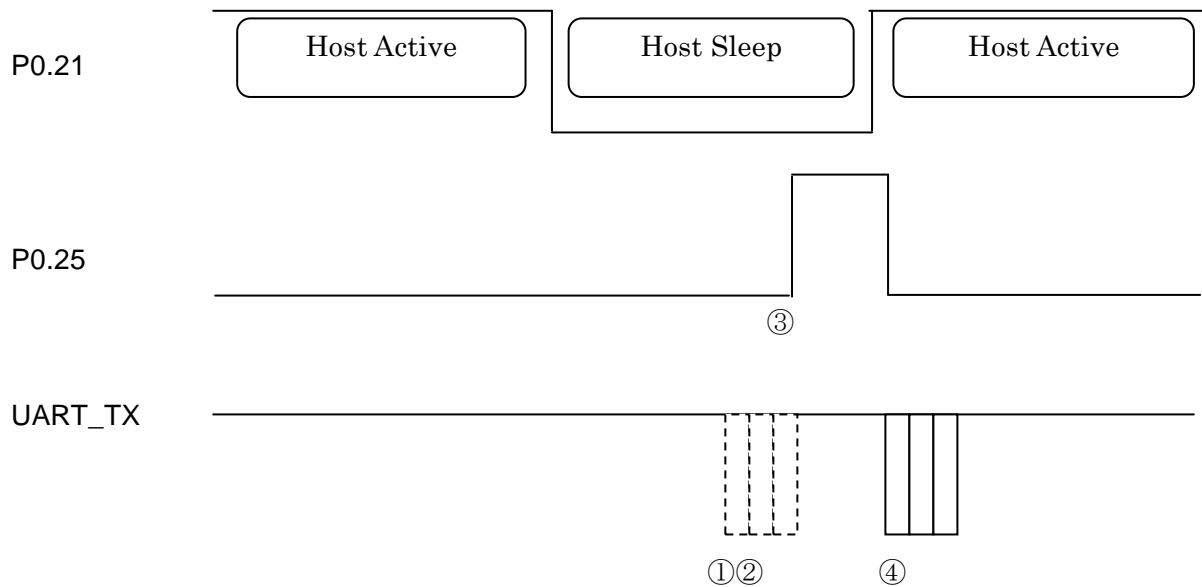

- ① Communication data or an event occurs in HOST Sleep.
- ② It waits until the host becomes active.
- ③ Module request to host wake-up via PIO.
- ④ If HOST becomes Active, module send communication data or event.

* **Buffer size : 128byte** If the buffer is full, further data received is discarded without any events.

13. DTM (Direct Test Mode)

13.1 Enter DTM and exit DTM (one-time)

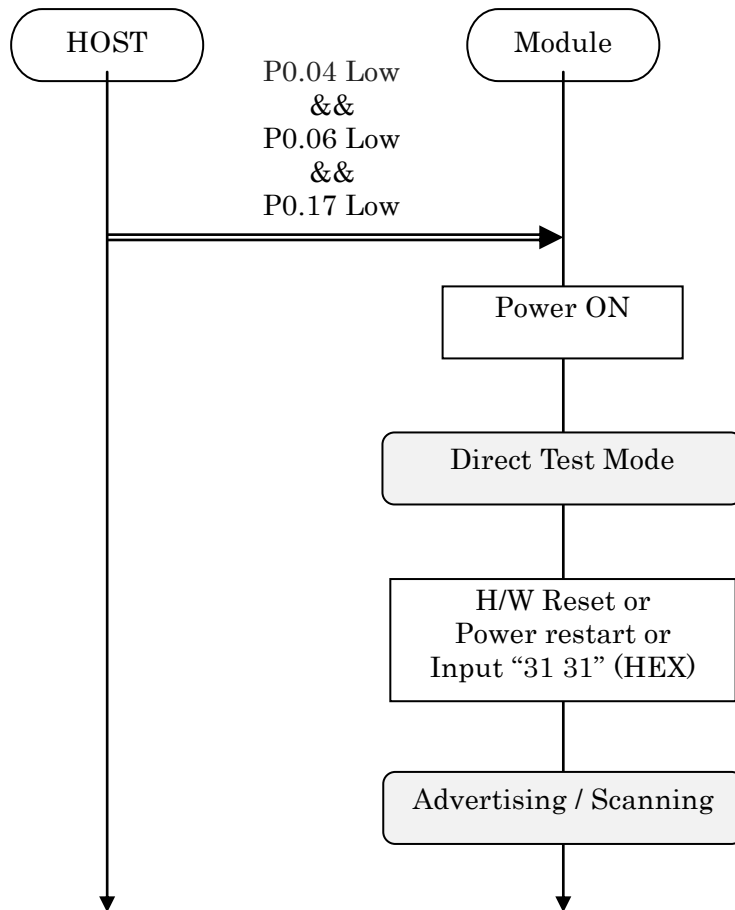

13.2 DTM Commands/Events

These commands/events are conforming to DTM of *Bluetooth*[®] specifications V4.0.

Please refer to *Bluetooth*[®] specifications V4.0.

(Core System Package [Low Energy Controller volume] Part F, Direct Test Mode)

EYSGCNAWY-1X

TAIYO YUDEN

14. GPIO check

Host can inspect GPIO by special commands in DTM.

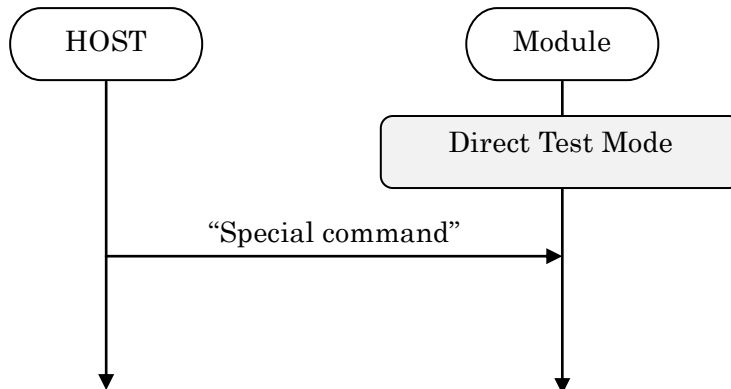

Command (Hex value)	Function	Response
32 30	It makes P0.05 Low.	00 00
32 31	It makes P0.05 High.	00 00
33 30	It makes P0.19 Low.	00 00
33 31	It makes P0.19 High.	00 00
34 30	It makes P0.25 Low.	00 00
34 31	It makes P0.25 High.	00 00
35 30	It makes P0.23 Low.	00 00
35 31	It makes P0.23 High.	00 00
39 39	It acquires state of Input Pin.	XX 00 00 XX: state Bit0: P0.04 (0:Low, 1:High) Bit1: P0.17 (0:Low, 1:High) Bit2: P0.06 (0:Low, 1:High) Bit3: P0.21 (0:Low, 1:High) Example 01 : P0.04 is High. Other Pin is Low. 0F: All Pin is High. 0B: P0.06 is Low. Other Pin is High.

15. Sleep Mode (SYSTEM ON)

This Sleep is available in during Advertising/Scanning and Connection.
 UART I/F is not usable during Sleep.

15.1 Enter sleep mode

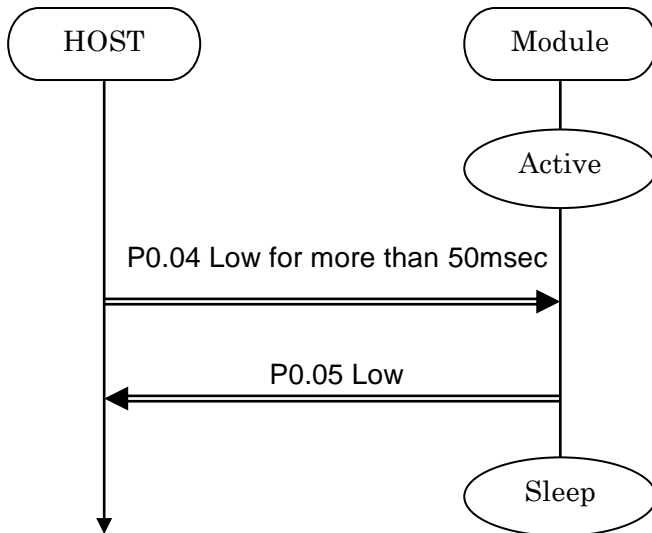

UART I/F is disable

In case of UART data happen, the module notify to Host via P0.25.
 It is same as "Host wake-up".

15.2 Exit sleep mode

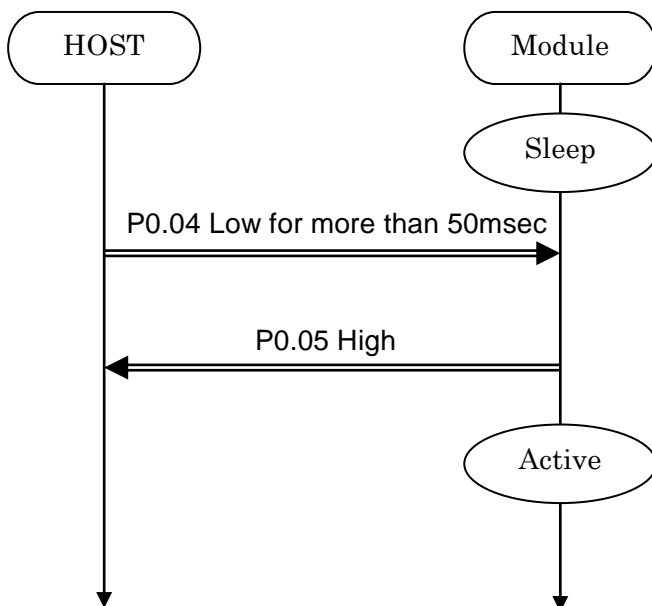

UART I/F is enable

EYSGCNAWY-1X

TAIYO YUDEN

16. Power saving mode (SYSTEM OFF)

16.1 Exit Power save

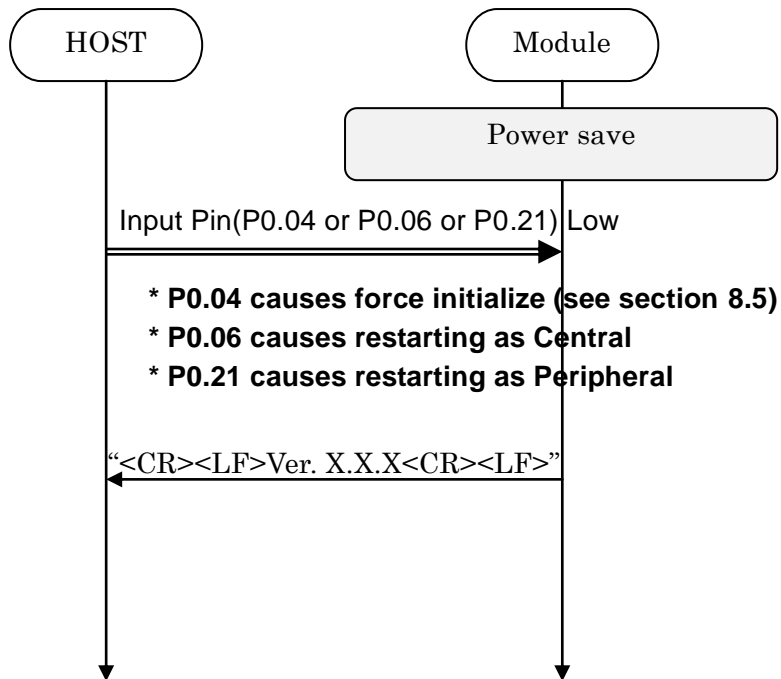

TAIYO YUDEN

17. Device Firmware updates (DFU)

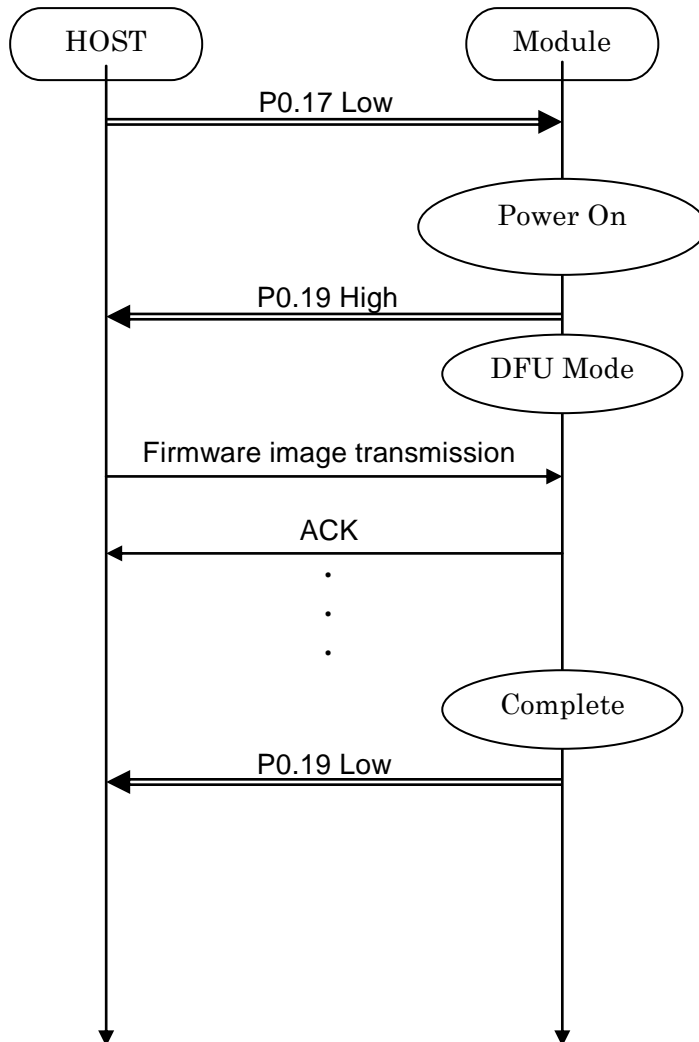
**UART**

Baud rate : 38400 bps

Data : 8 bit

Parity : none

Stop : 1 bit

Hardware flow control : Enabled

* Please contact TAIYO YUDEN when you use this function.

18. Notices

1. TYSA-B Lite uses softdevice S120 V2.1.0.
2. Connection Parameter Update by GPIO (P0.17) shall be performed after 1st update in 5 seconds from the connection establishment.
3. Connection Parameter Update by GPIO (P0.17) shall be performed in more than 2 seconds of interval.
4. The same GPIO (P0.06) is used for Both “Disconnect Request” and “Resume from Power Save”. Therefore, if P0.06 is kept Low after Disconnect for more than 300ms, the module restarts as Central.
See 7.7 **Disconnect Request** and 16.1 **Exit Power save**.
5. Data transmission is implemented with Notification and Write Command in GATT.
Because these commands are without ACK response, TYSA-B Lite is not able to guarantee the reaching of the data.
6. The buffer size for Sleep (Section 8.6) is 128byte.
If the buffer is full, further data received is discarded without any events.
7. The buffer size for Host wake-up (Chapter 12) is 128byte.
If the buffer is full, further data received is discarded without any events.