

Cree® XLamp® MHB-B LEDs



PRODUCT DESCRIPTION

The XLamp® MHB-B LED is a new high-power LED that enables a more effective way to lower system costs for high lumen lighting applications, such as high-bay, roadway and outdoor area, than mid-power LEDs.

Leveraging key elements of Cree’s SC5 Technology™ Platform, the ceramic MHB-B LEDs combine high light output, high efficacy and high reliability to enable high lumen LED designs that are not possible with mid-power LEDs.

The MHB-B LED delivers higher LPW than the MHB-A LED in the same 5mm x 5mm package, allowing lighting manufacturers to quickly increase performance for existing MHB designs without any additional investment.

FEATURES

- Flexible 9-V, 18-V or 36-V options
- Maximum drive current: 700 mA (9 V), 350 mA (18 V), 175 mA (36 V)
- Viewing angle: 115°
- Available in 70-CRI, 80-CRI and 90-CRI options
- Unlimited floor life at ≤ 30 °C/85% RH
- Reflow solderable - JEDEC J-STD-020C
- Electrically neutral thermal path
- RoHS and REACH compliant
- UL® recognized component (E349212)

TABLE OF CONTENTS

Characteristics	2
Flux Characteristics, EasyWhite® Order Codes and Bins - 9 V	3
Flux Characteristics, EasyWhite® Order Codes and Bins - 18 V	5
Flux Characteristics, EasyWhite® Order Codes and Bins - 36 V	7
Relative Spectral Power Distribution	9
Relative Flux vs. Junction Temperature	9
Electrical Characteristics	10
Relative Flux vs. Current	11
Relative Chromaticity vs. Current	13
Relative Chromaticity vs. Temperature	14
Typical Spatial Distribution	14
Thermal Design	15
Performance Groups – Luminous Flux ..	16
Thermal Design - Continued	16
Performance Groups – Chromaticity	17
Cree’s Standard White Chromaticity Regions Plotted on the 1931 CIE Curve ..	18
Bin and Order Code Formats	19
Reflow Soldering Characteristics	20
Notes	21
Mechanical Dimensions	23
Tape and Reel	24
Packaging	25



CHARACTERISTICS

Characteristics	Unit	Minimum	Typical	Maximum
Thermal resistance, junction to solder point	°C/W		4.0	
Viewing angle (FWHM)	degrees		115	
Temperature coefficient of voltage (9 V)	mV/°C		-4	
Temperature coefficient of voltage (18 V)	mV/°C		-8	
Temperature coefficient of voltage (36 V)	mV/°C		-16	
ESD withstand voltage (HBM per Mil-Std-883D)	V			8000
DC forward current (9 V)	mA			700
DC forward current (18 V)	mA			350
DC forward current (36 V)	mA			175
Reverse current	mA			0.1
Forward voltage (9 V, @ 480 mA, 85 °C)	V		8.75	
Forward voltage (9 V, @ 480 mA, 25 °C)	V			10
Forward voltage (18 V, @ 240 mA, 85 °C)	V		17.5	
Forward voltage (18 V, @ 240 mA, 25 °C)	V			20
Forward voltage (36 V, @ 120 mA, 85 °C)	V		35	
Forward voltage (36 V, @ 120 mA, 25 °C)	V			40
LED junction temperature	°C			150

FLUX CHARACTERISTICS, EASYWHITE® ORDER CODES AND BINS - 9 V

The following table provides order codes for XLamp MHB-B LEDs. For a complete description of the order code nomenclature, please see the Bin and Order Code Formats section (page 18).

Nominal CCT	CRI	Minimum Luminous Flux @ 480 mA			2-Step		3-Step		5-Step	
		Min	Group	Flux (lm) @ 85 °C	Flux (lm) @ 25 °C*	Group	Order Code	Group	Order Code	Group
6500 K	70	D4	550	609					65E	MHBBWT-0000-000C0BD465E
		E2	590	653						MHBBWT-0000-000C0BE265E
	80	D2	510	565					65E	MHBBWT-0000-000C0HD265E
		D4	550	609						MHBBWT-0000-000C0HD465E
5700 K	70	D4	550	609					57E	MHBBWT-0000-000C0BD457E
		E2	590	653						MHBBWT-0000-000C0BE257E
	80	D2	510	565					57E	MHBBWT-0000-000C0HD257E
		D4	550	609						MHBBWT-0000-000C0HD457E
	90	C2	440	487					57E	MHBBWT-0000-000C0UC257E
		C4	475	526						MHBBWT-0000-000C0UC457E
5000 K	70	D4	550	609					50E	MHBBWT-0000-000C0BD450E
		E2	590	653						MHBBWT-0000-000C0BE250E
	80	D2	510	565			50G	MHBBWT-0000-000C0HD250G		
		D4	550	609			50G	MHBBWT-0000-000C0HD450G		
	90	C2	440	487			50G	MHBBWT-0000-000C0UC250G		
		C4	475	526			50G	MHBBWT-0000-000C0UC450G		

Notes

- Cree maintains a tolerance of ±7% on flux and power measurements, ±0.005 on chromaticity (CCx, CCy) measurements and a tolerance of ±2 on CRI measurements. See the Measurements section (page 21).
- Cree XLamp MHB-B LED order codes specify only a minimum flux bin and not a maximum. Cree may ship reels in flux bins higher than the minimum specified by the order code without advance notice. Shipments will always adhere to the chromaticity bin restrictions specified by the order code.
- * Flux values @ 25 °C are calculated and for reference only.

FLUX CHARACTERISTICS, EASYWHITE® ORDER CODES AND BINS - 9 V - CONTINUED

Nominal CCT	CRI	Minimum Luminous Flux @ 480 mA			2-Step		3-Step		5-Step	
		Min	Group	Flux (lm) @ 85 °C	Flux (lm) @ 25 °C*	Group	Order Code	Group	Order Code	Group
4000 K	70	D4	550	609					40E	MHBBWT-0000-000C0BD440E
		E2	590	653						MHBBWT-0000-000C0BE240E
	80	D2	510	565	40H	MHBBWT-0000-000C0HD240H	40G	MHBBWT-0000-000C0HD240G		
		D4	550	609		MHBBWT-0000-000C0HD440H		MHBBWT-0000-000C0HD440G		
	90	C2	440	487	40H	MHBBWT-0000-000C0UC240H	40G	MHBBWT-0000-000C0UC240G		
		C4	475	526		MHBBWT-0000-000C0UC440H		MHBBWT-0000-000C0UC440G		
3500 K	80	C4	475	526	35H	MHBBWT-0000-000C0HC435H	35G	MHBBWT-0000-000C0HC435G		
		D2	510	565		MHBBWT-0000-000C0HD235H		MHBBWT-0000-000C0HD235G		
	90	B4	410	454	35H	MHBBWT-0000-000C0UB435H	35G	MHBBWT-0000-000C0UB435G		
		C2	440	487		MHBBWT-0000-000C0UC235H		MHBBWT-0000-000C0UC235G		
3000 K	70	D2	510	565					30E	MHBBWT-0000-000C0BD230E
		D4	550	609						MHBBWT-0000-000C0BD430E
	80	C4	475	526	30H	MHBBWT-0000-000C0HC430H	30G	MHBBWT-0000-000C0HC430G		
		D2	510	565		MHBBWT-0000-000C0HD230H		MHBBWT-0000-000C0HD230G		
	90	B4	410	454	30H	MHBBWT-0000-000C0UB430H	30G	MHBBWT-0000-000C0UB430G		
		C2	440	487		MHBBWT-0000-000C0UC230H		MHBBWT-0000-000C0UC230G		
2700 K	80	C2	440	487	27H	MHBBWT-0000-000C0HC227H	27G	MHBBWT-0000-000C0HC227G		
		C4	475	526		MHBBWT-0000-000C0HC427H		MHBBWT-0000-000C0HC427G		
	90	B2	380	421	27H	MHBBWT-0000-000C0UB227H	27G	MHBBWT-0000-000C0UB227G		
		B4	410	454		MHBBWT-0000-000C0UB427H		MHBBWT-0000-000C0UB427G		

Notes

- Cree maintains a tolerance of $\pm 7\%$ on flux and power measurements, ± 0.005 on chromaticity (CCx, CCy) measurements and a tolerance of ± 2 on CRI measurements. See the Measurements section (page 21).
- Cree XLamp MHB-B LED order codes specify only a minimum flux bin and not a maximum. Cree may ship reels in flux bins higher than the minimum specified by the order code without advance notice. Shipments will always adhere to the chromaticity bin restrictions specified by the order code.
- * Flux values @ 25 °C are calculated and for reference only.

FLUX CHARACTERISTICS, EASYWHITE® ORDER CODES AND BINS - 18 V

The following table provides order codes for XLamp MHB-B LEDs. For a complete description of the order code nomenclature, please see the Bin and Order Code Formats section (page 18).

Nominal CCT	CRI	Minimum Luminous Flux @ 240 mA			2-Step		3-Step		5-Step	
		Min	Group	Flux (lm) @ 85 °C	Flux (lm) @ 25 °C*	Group	Order Code	Group	Order Code	Group
6500 K	70	D4	550	609					65E	MHBBWT-0000-000F0BD465E
		E2	590	653						MHBBWT-0000-000F0BE265E
	80	D2	510	565					65E	MHBBWT-0000-000F0HD265E
		D4	550	609						MHBBWT-0000-000F0HD465E
5700 K	70	D4	550	609					57E	MHBBWT-0000-000F0BD457E
		E2	590	653						MHBBWT-0000-000F0BE257E
	80	D2	510	565					57E	MHBBWT-0000-000F0HD257E
		D4	550	609						MHBBWT-0000-000F0HD457E
	90	C2	440	487					57E	MHBBWT-0000-000F0UC257E
		C4	475	526						MHBBWT-0000-000F0UC457E
5000 K	70	D4	550	609					50E	MHBBWT-0000-000F0BD450E
		E2	590	653						MHBBWT-0000-000F0BE250E
	80	D2	510	565			50G	MHBBWT-0000-000F0HD250G		
		D4	550	609			50G	MHBBWT-0000-000F0HD450G		
	90	C2	440	487			50G	MHBBWT-0000-000F0UC250G		
		C4	475	526			50G	MHBBWT-0000-000F0UC450G		

Notes

- Cree maintains a tolerance of $\pm 7\%$ on flux and power measurements, ± 0.005 on chromaticity (CCx, CCy) measurements and a tolerance of ± 2 on CRI measurements. See the Measurements section (page 21).
- Cree XLamp MHB-B LED order codes specify only a minimum flux bin and not a maximum. Cree may ship reels in flux bins higher than the minimum specified by the order code without advance notice. Shipments will always adhere to the chromaticity bin restrictions specified by the order code.
- * Flux values @ 25 °C are calculated and for reference only.

FLUX CHARACTERISTICS, EASYWHITE® ORDER CODES AND BINS - 18 V - CONTINUED

Nominal CCT	CRI	Minimum Luminous Flux @ 240 mA			2-Step		3-Step		5-Step	
		Min	Group	Flux (lm) @ 85 °C	Flux (lm) @ 25 °C*	Group	Order Code	Group	Order Code	Group
4000 K	70	D4	550	609					40E	MHBBWT-0000-000F0BD440E
		E2	590	653						MHBBWT-0000-000F0BE240E
	80	D2	510	565	40H	MHBBWT-0000-000F0HD240H	40G	MHBBWT-0000-000F0HD240G		
		D4	550	609		MHBBWT-0000-000F0HD440H		MHBBWT-0000-000F0HD440G		
	90	C2	440	487	40H	MHBBWT-0000-000F0UC240H	40G	MHBBWT-0000-000F0UC240G		
		C4	475	526		MHBBWT-0000-000F0UC440H		MHBBWT-0000-000F0UC440G		
3500 K	80	C4	475	526	35H	MHBBWT-0000-000F0HC435H	35G	MHBBWT-0000-000F0HC435G		
		D2	510	565		MHBBWT-0000-000F0HD235H		MHBBWT-0000-000F0HD235G		
	90	B4	410	454	35H	MHBBWT-0000-000F0UB435H	35G	MHBBWT-0000-000F0UB435G		
		C2	440	487		MHBBWT-0000-000F0UC235H		MHBBWT-0000-000F0UC235G		
3000 K	70	D2	510	565					30E	MHBBWT-0000-000F0BD230E
		D4	550	609						MHBBWT-0000-000F0BD430E
	80	C4	475	526	30H	MHBBWT-0000-000F0HC430H	30G	MHBBWT-0000-000F0HC430G		
		D2	510	565		MHBBWT-0000-000F0HD230H		MHBBWT-0000-000F0HD230G		
	90	B4	410	454	30H	MHBBWT-0000-000F0UB430H	30G	MHBBWT-0000-000F0UB430G		
		C2	440	487		MHBBWT-0000-000F0UC230H		MHBBWT-0000-000F0UC230G		
2700 K	80	C2	440	487	27H	MHBBWT-0000-000F0HC227H	27G	MHBBWT-0000-000F0HC227G		
		C4	475	526		MHBBWT-0000-000F0HC427H		MHBBWT-0000-000F0HC427G		
	90	B2	380	421	27H	MHBBWT-0000-000F0UB227H	27G	MHBBWT-0000-000F0UB227G		
		B4	410	454		MHBBWT-0000-000F0UB427H		MHBBWT-0000-000F0UB427G		

Notes

- Cree maintains a tolerance of $\pm 7\%$ on flux and power measurements, ± 0.005 on chromaticity (CCx, CCy) measurements and a tolerance of ± 2 on CRI measurements. See the Measurements section (page 21).
- Cree XLamp MHB-B LED order codes specify only a minimum flux bin and not a maximum. Cree may ship reels in flux bins higher than the minimum specified by the order code without advance notice. Shipments will always adhere to the chromaticity bin restrictions specified by the order code.
- * Flux values @ 25 °C are calculated and for reference only.

FLUX CHARACTERISTICS, EASYWHITE® ORDER CODES AND BINS - 36 V

The following table provides order codes for XLamp MHB-B LEDs. For a complete description of the order code nomenclature, please see the Bin and Order Code Formats section (page 18).

Nominal CCT	CRI	Minimum Luminous Flux @ 120 mA			2-Step		3-Step		5-Step	
		Min	Group	Flux (lm) @ 85 °C	Flux (lm) @ 25 °C*	Group	Order Code	Group	Order Code	Group
6500 K	70	D4	550	609					65E	MHBBWT-0000-000N0BD465E
		E2	590	653						MHBBWT-0000-000N0BE265E
	80	D2	510	565					65E	MHBBWT-0000-000N0HD265E
		D4	550	609						MHBBWT-0000-000N0HD465E
5700 K	70	D4	550	609					57E	MHBBWT-0000-000N0BD457E
		E2	590	653						MHBBWT-0000-000N0BE257E
	80	D2	510	565					57E	MHBBWT-0000-000N0HD257E
		D4	550	609						MHBBWT-0000-000N0HD457E
	90	C2	440	487					57E	MHBBWT-0000-000N0UC257E
		C4	475	526						MHBBWT-0000-000N0UC457E
5000 K	70	D4	550	609					50E	MHBBWT-0000-000N0BD450E
		E2	590	653						MHBBWT-0000-000N0BE250E
	80	D2	510	565			50G	MHBBWT-0000-000N0HD250G		
		D4	550	609			50G	MHBBWT-0000-000N0HD450G		
	90	C2	440	487			50G	MHBBWT-0000-000N0UC250G		
		C4	475	526			50G	MHBBWT-0000-000N0UC450G		

Notes

- Cree maintains a tolerance of $\pm 7\%$ on flux and power measurements, ± 0.005 on chromaticity (CCx, CCy) measurements and a tolerance of ± 2 on CRI measurements. See the Measurements section (page 21).
- Cree XLamp MHB-B LED order codes specify only a minimum flux bin and not a maximum. Cree may ship reels in flux bins higher than the minimum specified by the order code without advance notice. Shipments will always adhere to the chromaticity bin restrictions specified by the order code.
- * Flux values @ 25 °C are calculated and for reference only.

FLUX CHARACTERISTICS, EASYWHITE® ORDER CODES AND BINS - 36 V - CONTINUED

Nominal CCT	CRI	Minimum Luminous Flux @ 120 mA			2-Step		3-Step		5-Step	
		Min	Group	Flux (lm) @ 85 °C	Flux (lm) @ 25 °C*	Group	Order Code	Group	Order Code	Group
4000 K	70	D4	550	609					40E	MHBBWT-0000-000N0BD440E
		E2	590	653						MHBBWT-0000-000N0BE240E
	80	D2	510	565	40H	MHBBWT-0000-000N0HD240H	40G	MHBBWT-0000-000N0HD240G		
		D4	550	609		MHBBWT-0000-000N0HD440H		MHBBWT-0000-000N0HD440G		
	90	C2	440	487	40H	MHBBWT-0000-000N0UC240H	40G	MHBBWT-0000-000N0UC240G		
		C4	475	526		MHBBWT-0000-000N0UC440H		MHBBWT-0000-000N0UC440G		
3500 K	80	C4	475	526	35H	MHBBWT-0000-000N0HC435H	35G	MHBBWT-0000-000N0HC435G		
		D2	510	565		MHBBWT-0000-000N0HD235H		MHBBWT-0000-000N0HD235G		
	90	B4	410	454	35H	MHBBWT-0000-000N0UB435H	35G	MHBBWT-0000-000N0UB435G		
		C2	440	487		MHBBWT-0000-000N0UC235H		MHBBWT-0000-000N0UC235G		
3000 K	70	D2	510	565					30E	MHBBWT-0000-000N0BD230E
		D4	550	609						MHBBWT-0000-000N0BD430E
	80	C4	475	526	30H	MHBBWT-0000-000N0HC430H	30G	MHBBWT-0000-000N0HC430G		
		D2	510	565		MHBBWT-0000-000N0HD230H		MHBBWT-0000-000N0HD230G		
	90	B4	410	454	30H	MHBBWT-0000-000N0UB430H	30G	MHBBWT-0000-000N0UB430G		
		C2	440	487		MHBBWT-0000-000N0UC230H		MHBBWT-0000-000N0UC230G		
2700 K	80	C2	440	487	27H	MHBBWT-0000-000N0HC227H	27G	MHBBWT-0000-000N0HC227G		
		C4	475	526		MHBBWT-0000-000N0HC427H		MHBBWT-0000-000N0HC427G		
	90	B2	380	421	27H	MHBBWT-0000-000N0UB227H	27G	MHBBWT-0000-000N0UB227G		
		B4	410	454		MHBBWT-0000-000N0UB427H		MHBBWT-0000-000N0UB427G		

Notes

- Cree maintains a tolerance of $\pm 7\%$ on flux and power measurements, ± 0.005 on chromaticity (CCx, CCy) measurements and a tolerance of ± 2 on CRI measurements. See the Measurements section (page 21).
- Cree XLamp MHB-B LED order codes specify only a minimum flux bin and not a maximum. Cree may ship reels in flux bins higher than the minimum specified by the order code without advance notice. Shipments will always adhere to the chromaticity bin restrictions specified by the order code.
- * Flux values @ 25 °C are calculated and for reference only.

RELATIVE SPECTRAL POWER DISTRIBUTION

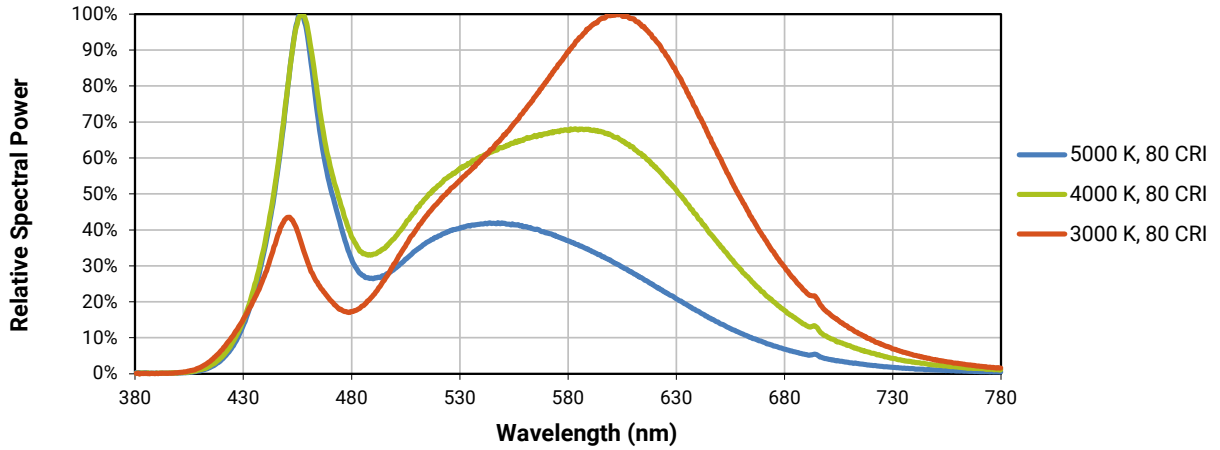

RELATIVE FLUX VS. JUNCTION TEMPERATURE

Test condition: 9 V, $I_f = 480$ mA; 18 V, $I_f = 240$ mA; 36 V, $I_f = 120$ mA

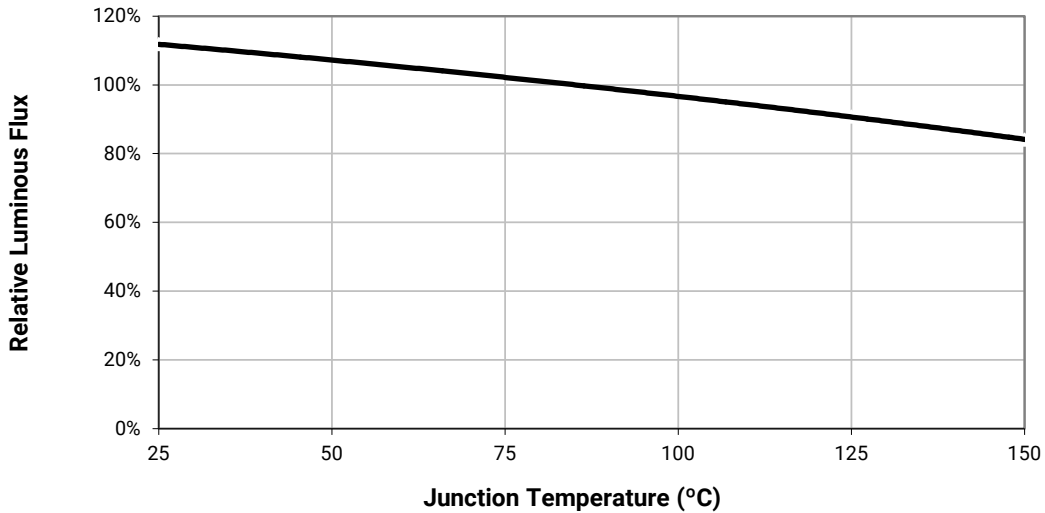

ELECTRICAL CHARACTERISTICS ($T_j = 85\text{ }^\circ\text{C}$)

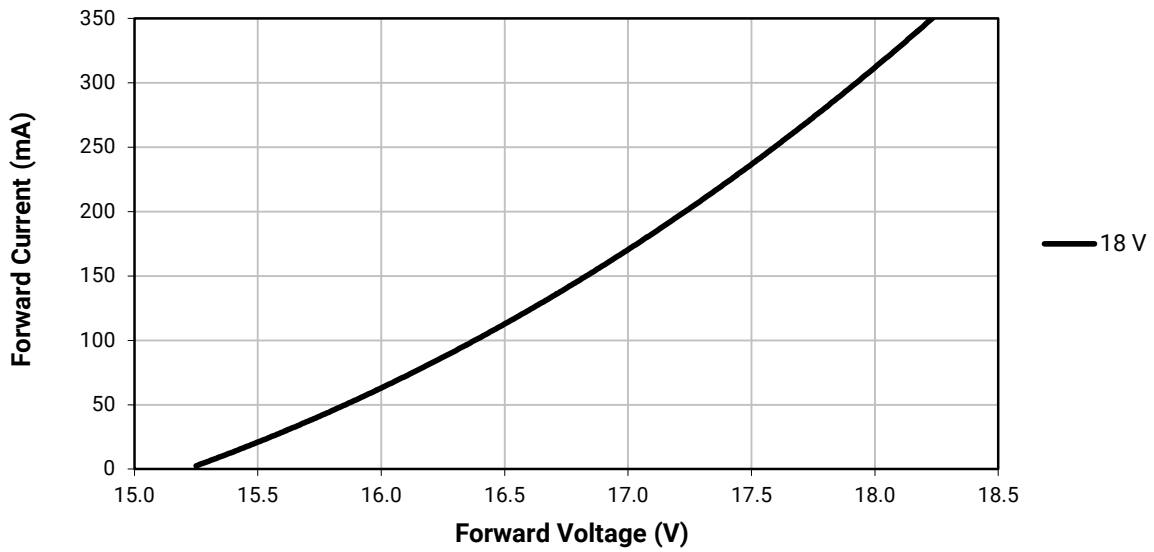
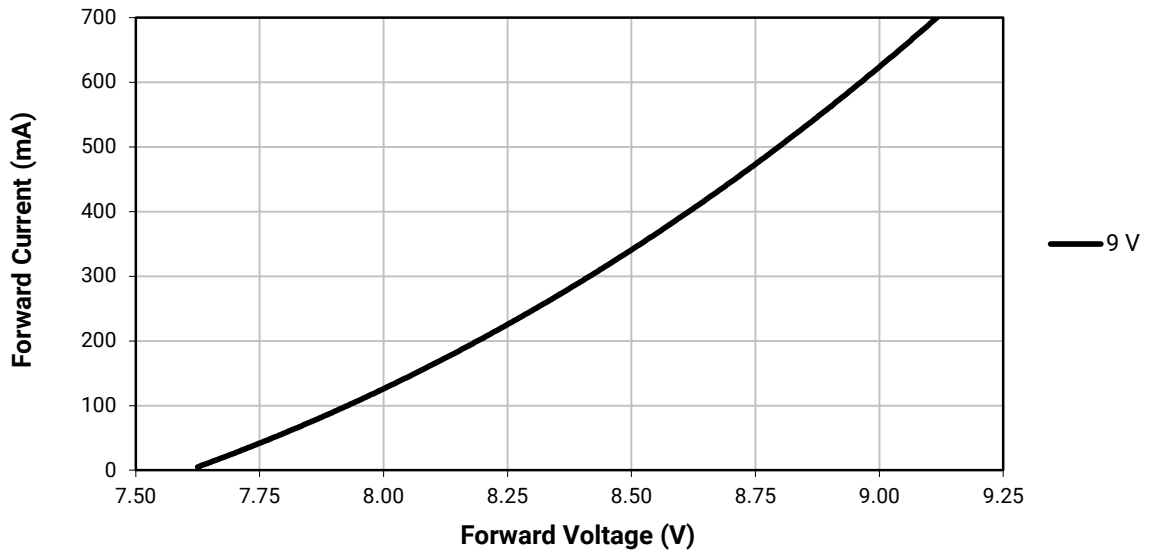

ELECTRICAL CHARACTERISTICS ($T_j = 85\text{ }^\circ\text{C}$) - CONTINUED

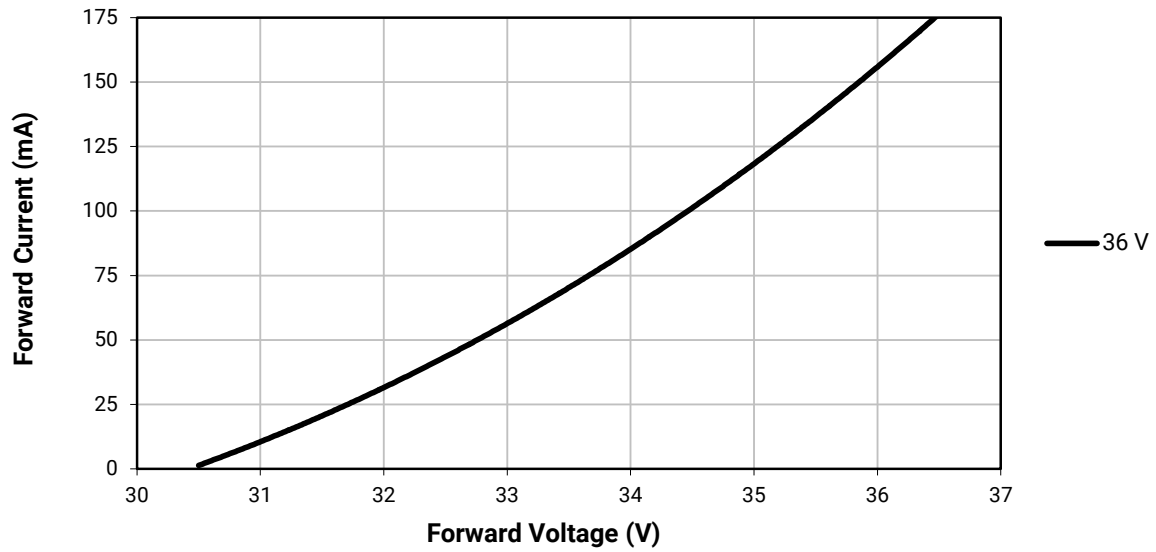

RELATIVE FLUX VS. CURRENT ($T_j = 85\text{ }^\circ\text{C}$)

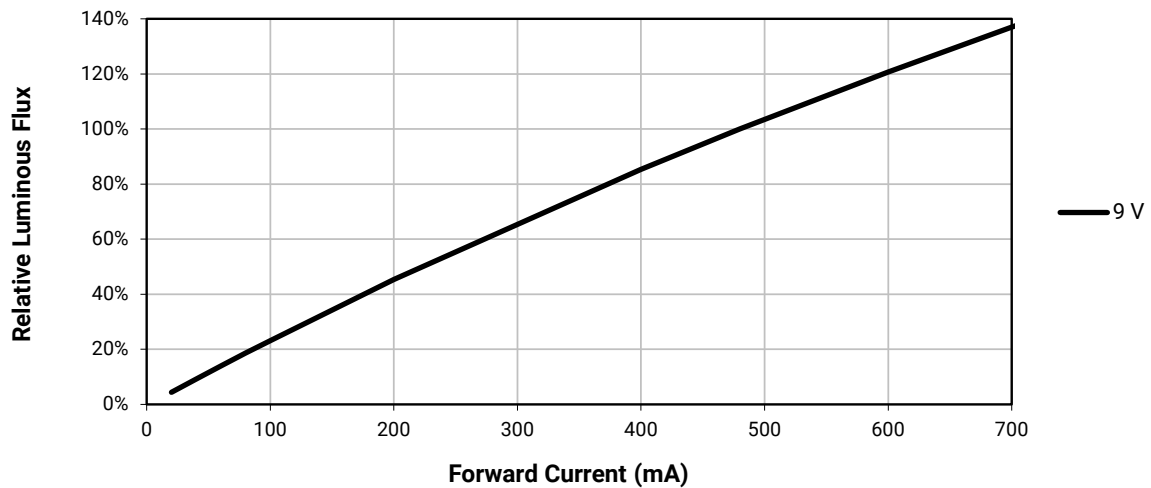

RELATIVE FLUX VS. CURRENT ($T_j = 85\text{ }^\circ\text{C}$) - CONTINUED

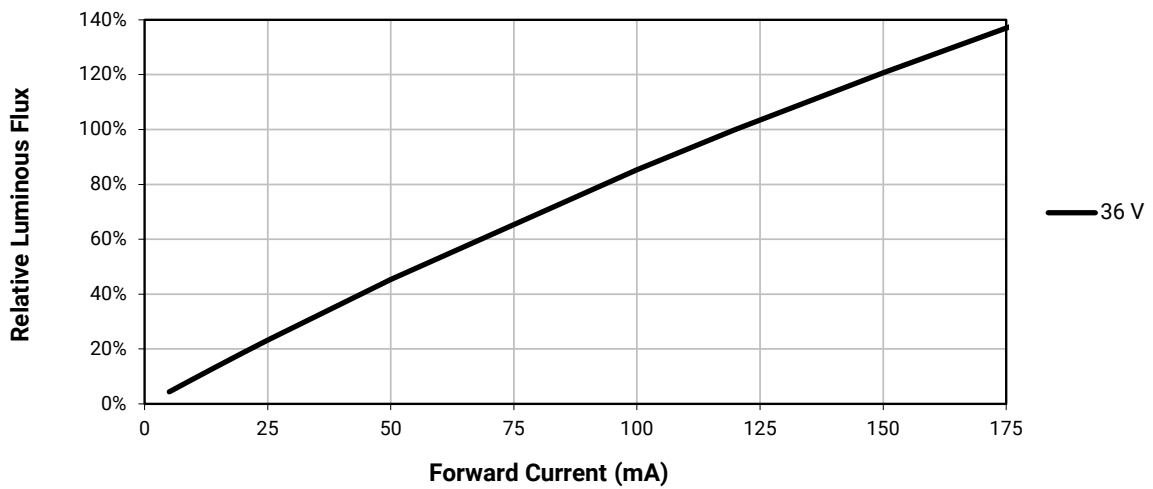
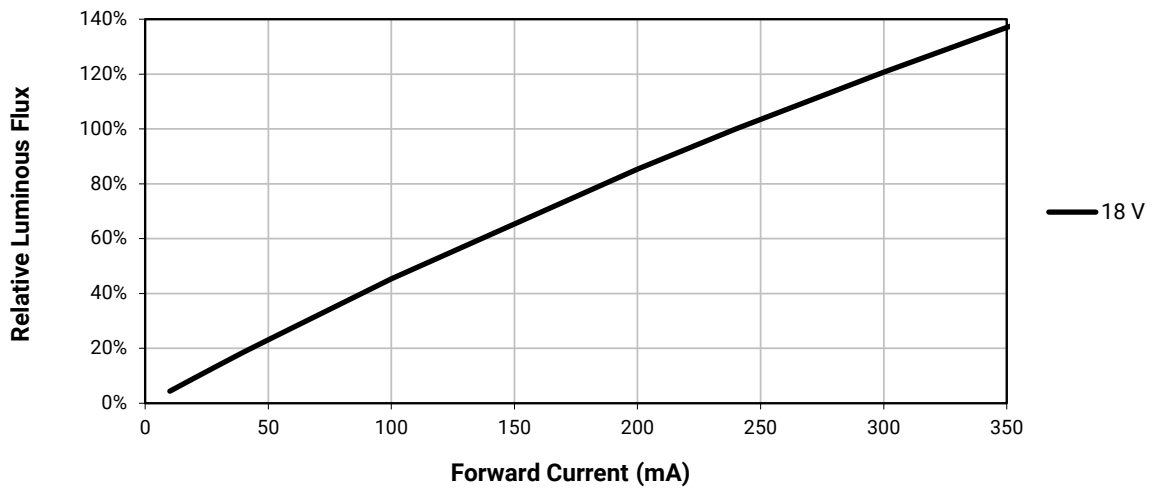

RELATIVE CHROMATICITY VS. CURRENT

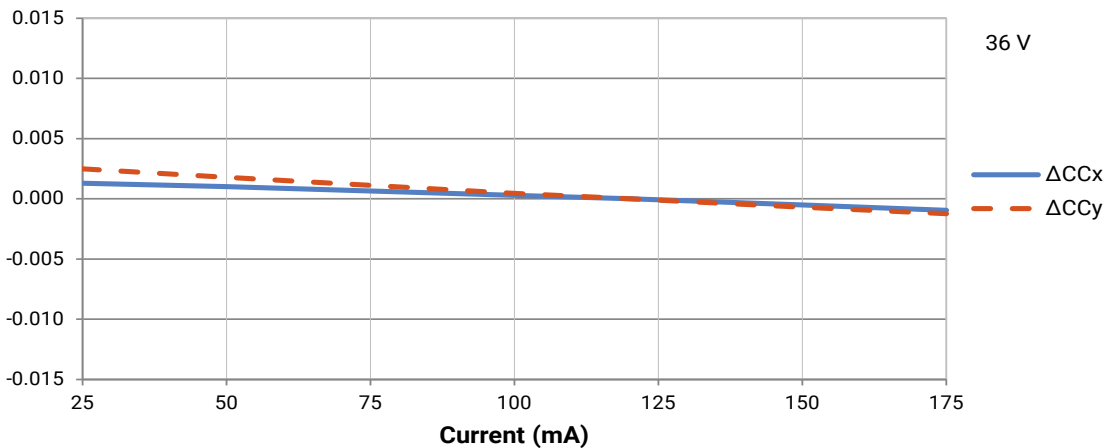
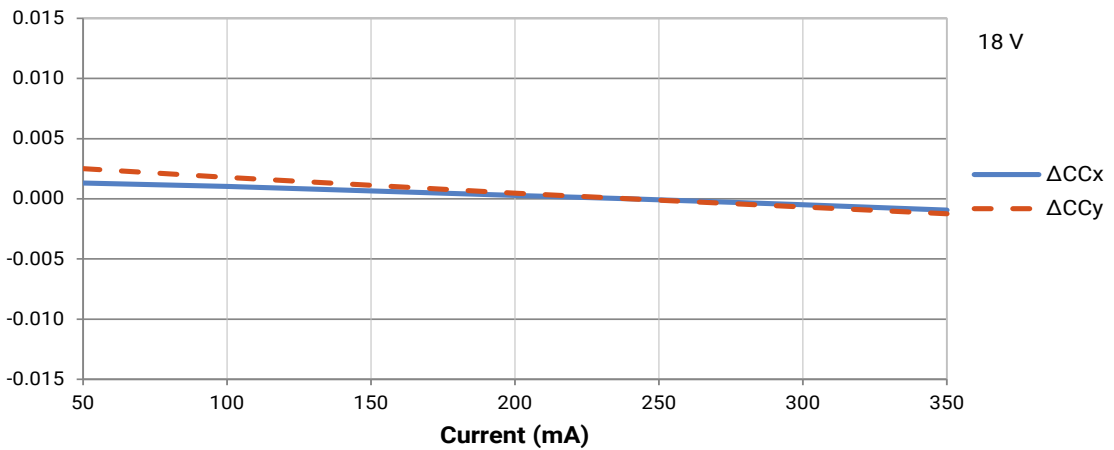
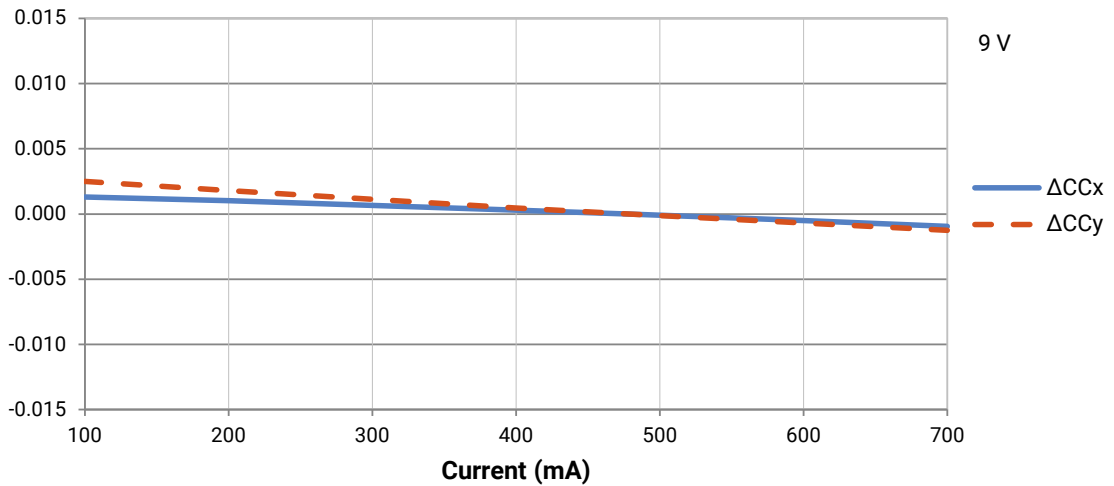

RELATIVE CHROMATICITY VS. TEMPERATURE

Test condition: 9 V, $I_f = 480$ mA; 18 V, $I_f = 240$ mA; 36 V, $I_f = 120$ mA

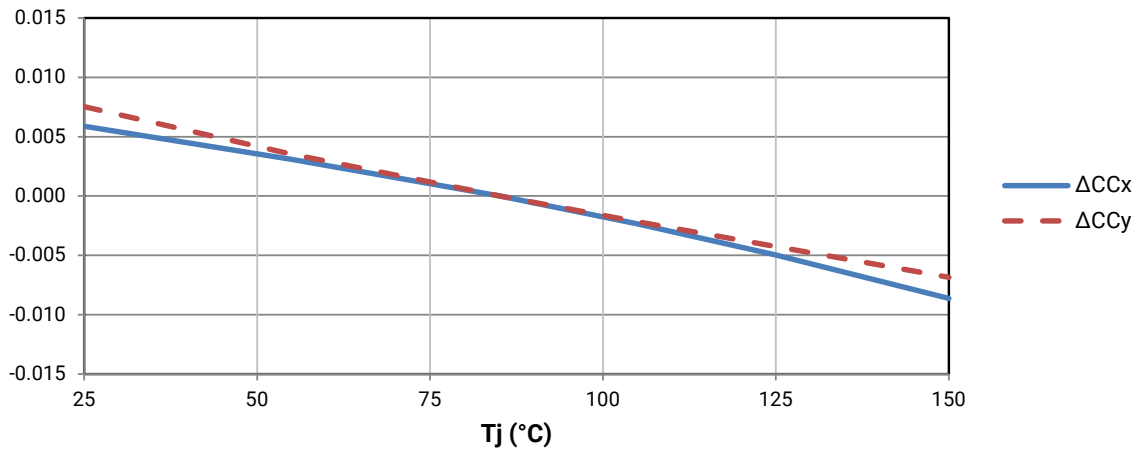

TYPICAL SPATIAL DISTRIBUTION

Test condition: 9 V, $I_f = 480$ mA; 18 V, $I_f = 240$ mA; 36 V, $I_f = 120$ mA

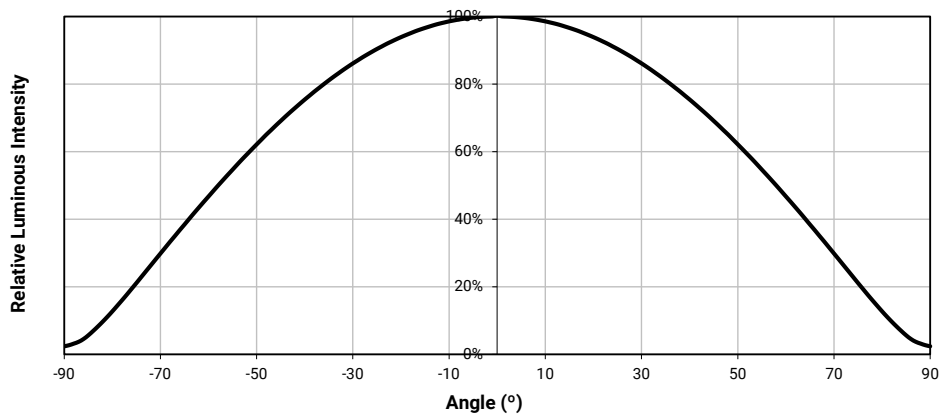

THERMAL DESIGN

The maximum forward current is determined by the thermal resistance between the LED junction and ambient. It is crucial for the end product to be designed in a manner that minimizes the thermal resistance from the solder point to ambient in order to optimize lamp life and optical characteristics.

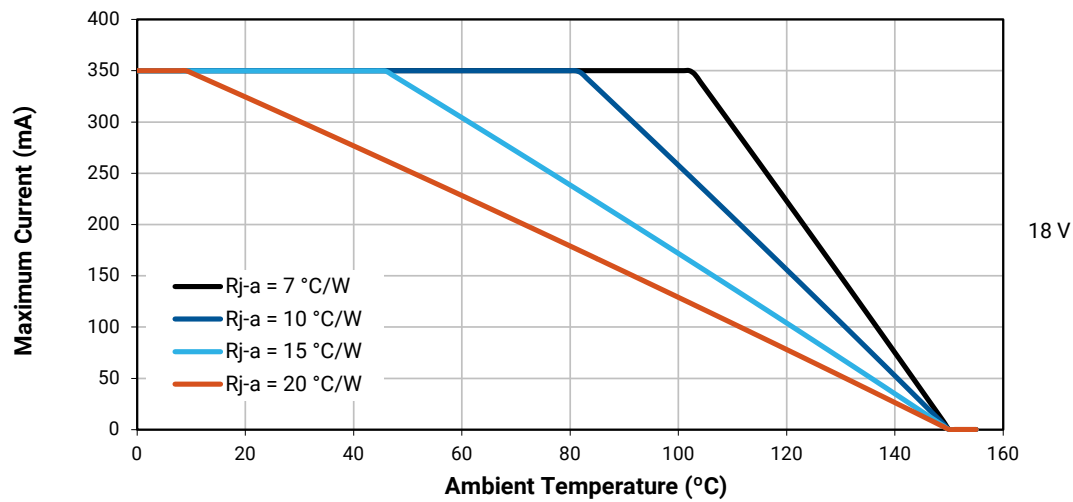
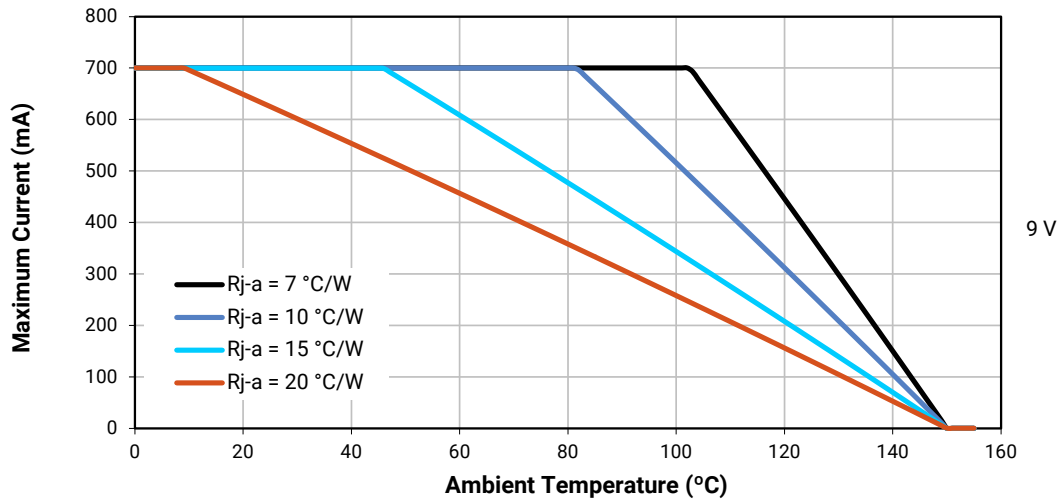

THERMAL DESIGN - CONTINUED

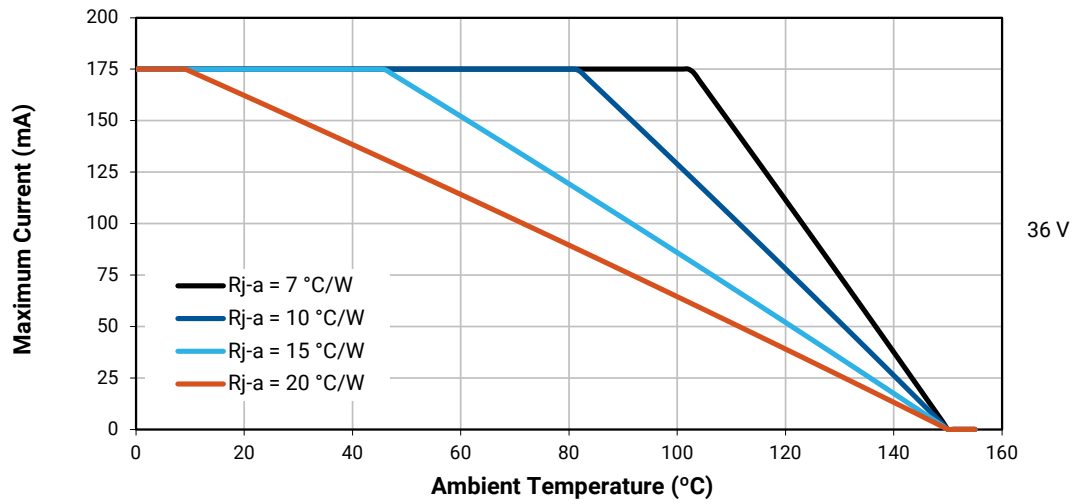

PERFORMANCE GROUPS – LUMINOUS FLUX ($T_j = 85\text{ °C}$)

XLamp MHB-B LEDs are tested for luminous flux and placed into one of the following bins.

Group Code	Minimum Luminous Flux	Maximum Luminous Flux
B4	410	440
C2	440	475
C4	475	510
D2	510	550
D4	550	590
E2	590	635
E4	635	680
F2	680	730

PERFORMANCE GROUPS – CHROMATICITY

XLamp MHB-B LEDs are tested for chromaticity and placed into one of the regions defined by the following bounding coordinates.

EasyWhite Color Temperatures – 2-Step			
Code	CCT	x	y
40H	4000 K	0.3777	0.3739
		0.3797	0.3816
		0.3861	0.3855
		0.3838	0.3777
35H	3500 K	0.4022	0.3858
		0.4053	0.3942
		0.4125	0.3977
		0.4091	0.3891
30H	3000 K	0.4287	0.3975
		0.4328	0.4064
		0.4390	0.4086
		0.4347	0.3996
27H	2700 K	0.4524	0.4048
		0.4574	0.4140
		0.4633	0.4154
		0.4581	0.4062

EasyWhite Color Temperatures – 3-Step Ellipse						
Bin Code	CCT	Center Point		Major Axis	Minor Axis	Rotation Angle (°)
		x	y	a	b	
50G	5000 K	0.3447	0.3553	0.00840	0.00312	65.0
40G	4000 K	0.3818	0.3797	0.00939	0.00402	53.7
35G	3500 K	0.4073	0.3917	0.00927	0.00414	53.2
30G	3000 K	0.4338	0.4030	0.00834	0.00408	53.2
27G	2700 K	0.4577	0.4099	0.00834	0.00420	48.5

EasyWhite Color Temperatures – 5-Step Ellipse						
Bin Code	CCT	Center Point		Major Axis	Minor Axis	Rotation Angle (°)
		x	y	a	b	
65E	6500 K	0.3123	0.3282	0.01110	0.00550	61.0
57E	5700 K	0.3287	0.3417	0.01230	0.00600	72.0
50E	5000 K	0.3447	0.3553	0.01400	0.00520	65.0
40E	4000 K	0.3818	0.3797	0.01565	0.00670	53.7
30E	3000 K	0.4338	0.4030	0.01390	0.00680	53.2

CREE'S STANDARD WHITE CHROMATICITY REGIONS PLOTTED ON THE 1931 CIE CURVE

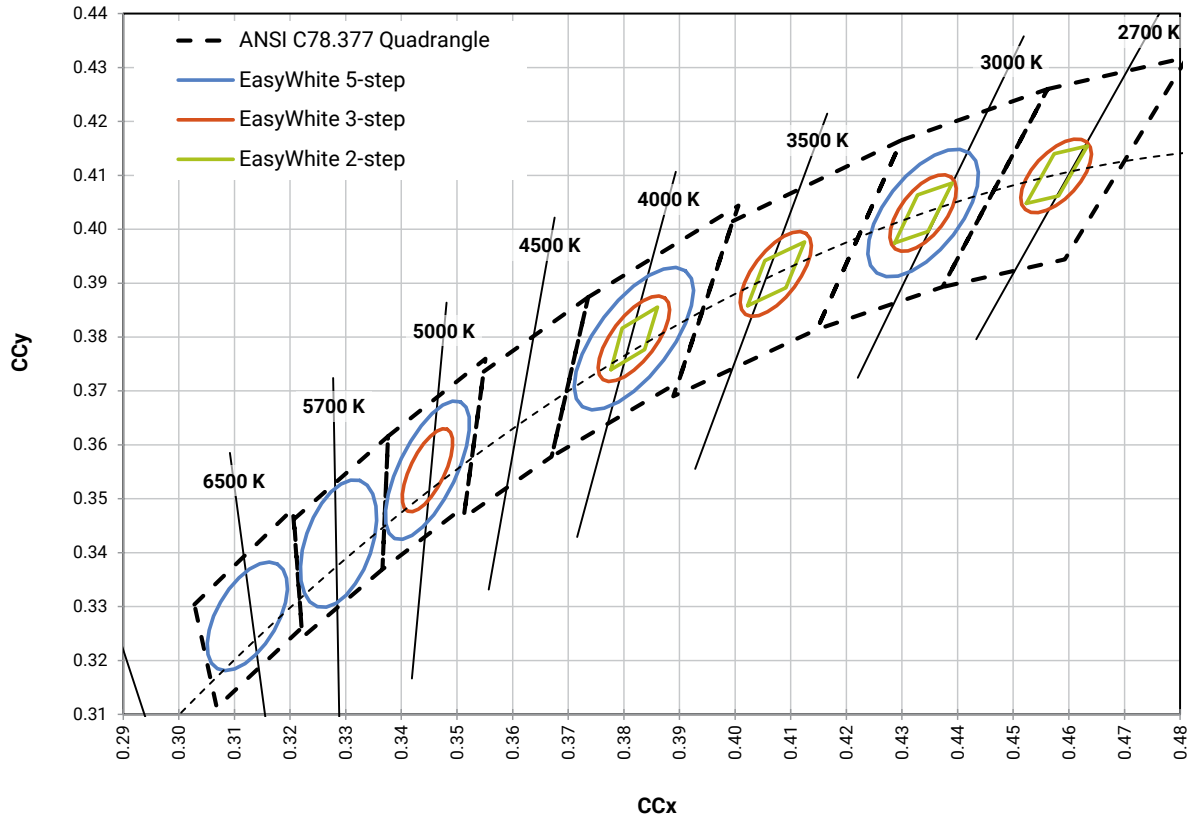

BIN AND ORDER CODE FORMATS

Bin codes and order codes for MHB-B LEDs are configured in the following manner:

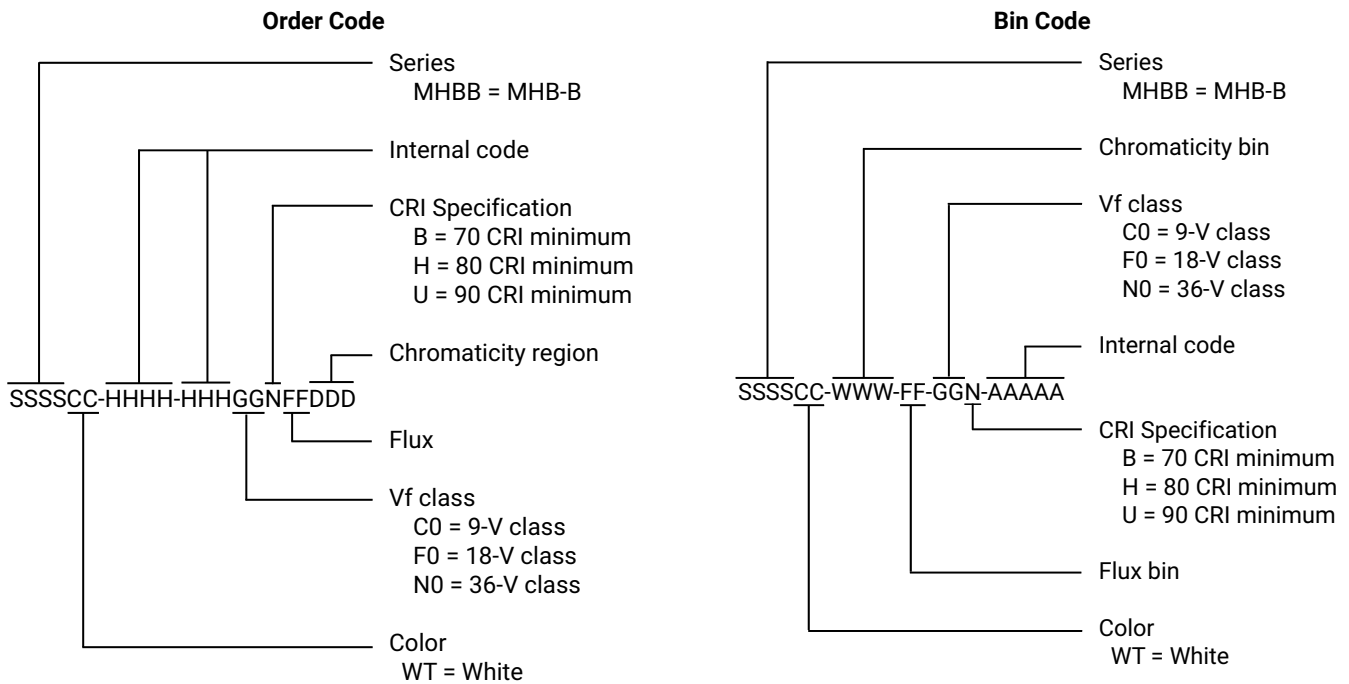

REFLOW SOLDERING CHARACTERISTICS

In testing, Cree has found XLamp MHB-B LEDs to be compatible with JEDEC J-STD-020C, using the parameters listed below. As a general guideline, Cree recommends that users follow the recommended soldering profile provided by the manufacturer of the solder paste used.

Note that this general guideline may not apply to all PCB designs and configurations of reflow soldering equipment.

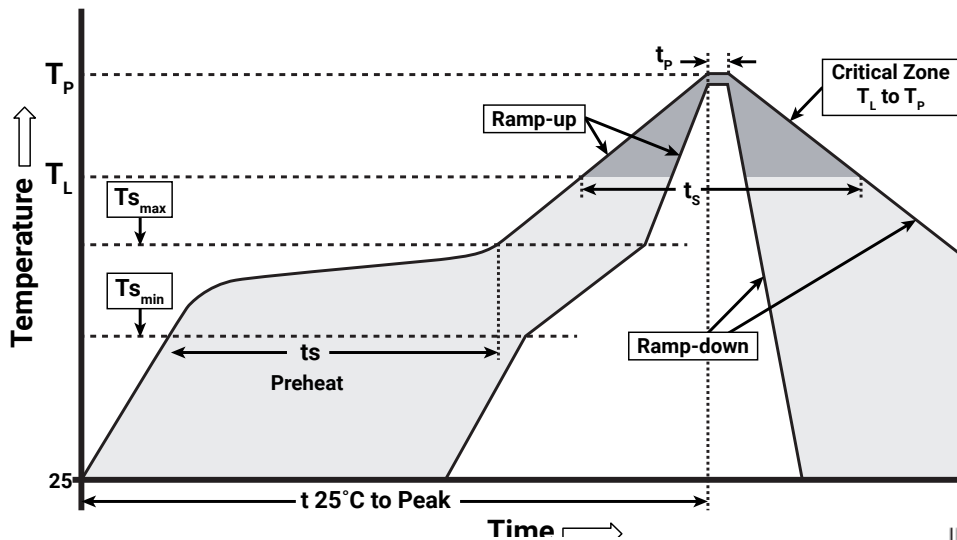

IPC/JEDEC J-STD-020C

Profile Feature	Lead-Free Solder
Average Ramp-Up Rate (Ts_{max} to T_p)	1.2 °C/second
Preheat: Temperature Min (Ts_{min})	120 °C
Preheat: Temperature Max (Ts_{max})	170 °C
Preheat: Time (ts_{min} to ts_{max})	65-150 seconds
Time Maintained Above: Temperature (T_L)	217 °C
Time Maintained Above: Time (t_L)	45-90 seconds
Peak/Classification Temperature (T_p)	235 - 245 °C
Time Within 5 °C of Actual Peak Temperature (t_p)	20-40 seconds
Ramp-Down Rate	1 - 6 °C/second
Time 25 °C to Peak Temperature	4 minutes max.

Note: All temperatures refer to the topside of the package, measured on the package body surface.

NOTES

Measurements

The luminous flux, radiant power, chromaticity, forward voltage and CRI measurements in this document are binning specifications only and solely represent product measurements as of the date of shipment. These measurements will change over time based on a number of factors that are not within Cree's control and are not intended or provided as operational specifications for the products. Calculated values are provided for informational purposes only and are not intended as specifications.

Pre-Release Qualification Testing

Please read the [LED Reliability Overview](#) for details of the qualification process Cree applies to ensure long-term reliability for XLamp LEDs and details of Cree's pre-release qualification testing for XLamp LEDs.

Lumen Maintenance

Cree now uses standardized IES LM-80-08 and TM-21-11 methods for collecting long-term data and extrapolating LED lumen maintenance. For information on the specific LM-80 data sets available for this LED, refer to the public [LM-80 results document](#).

Please read the [Long-Term Lumen Maintenance application note](#) for more details on Cree's lumen maintenance testing and forecasting. Please read the [Thermal Management application note](#) for details on how thermal design, ambient temperature, and drive current affect the LED junction temperature.

Moisture Sensitivity

Cree recommends keeping XLamp LEDs in the provided, resealable moisture-barrier packaging (MBP) until immediately prior to soldering. Unopened MBPs that contain XLamp LEDs do not need special storage for moisture sensitivity.

Once the MBP is opened, XLamp MHB-B LEDs may be stored as MSL 1 per JEDEC J-STD-033, meaning they have unlimited floor life in conditions of ≤ 30 °C/85% relative humidity (RH). Regardless of the storage condition, Cree recommends sealing any unsoldered LEDs in the original MBP.

RoHS Compliance

The levels of RoHS restricted materials in this product are below the maximum concentration values (also referred to as the threshold limits) permitted for such substances, or are used in an exempted application, in accordance with EU Directive 2011/65/EC (RoHS2), as implemented January 2, 2013. RoHS Declarations for this product can be obtained from your Cree representative or from the [Product Ecology](#) section of the Cree website.

REACH Compliance

REACH substances of very high concern (SVHCs) information is available for this product. Since the European Chemical Agency (ECHA) has published notice of their intent to frequently revise the SVHC listing for the foreseeable future, please contact a Cree representative to insure you get the most up-to-date REACH Declaration. REACH banned substance information (REACH Article 67) is also available upon request.

NOTES - CONTINUED

UL® Recognized Component

Level 4 enclosure consideration. The LED package or a portion thereof has been investigated as a fire and electrical enclosure per ANSI/UL 8750.

Vision Advisory

WARNING: Do not look at an exposed lamp in operation. Eye injury can result. For more information about LEDs and eye safety, please refer to the [LED Eye Safety application note](#).

MECHANICAL DIMENSIONS

Thermal vias, if present, are not shown on these drawings.

All measurements are ± 0.13 mm unless otherwise indicated.

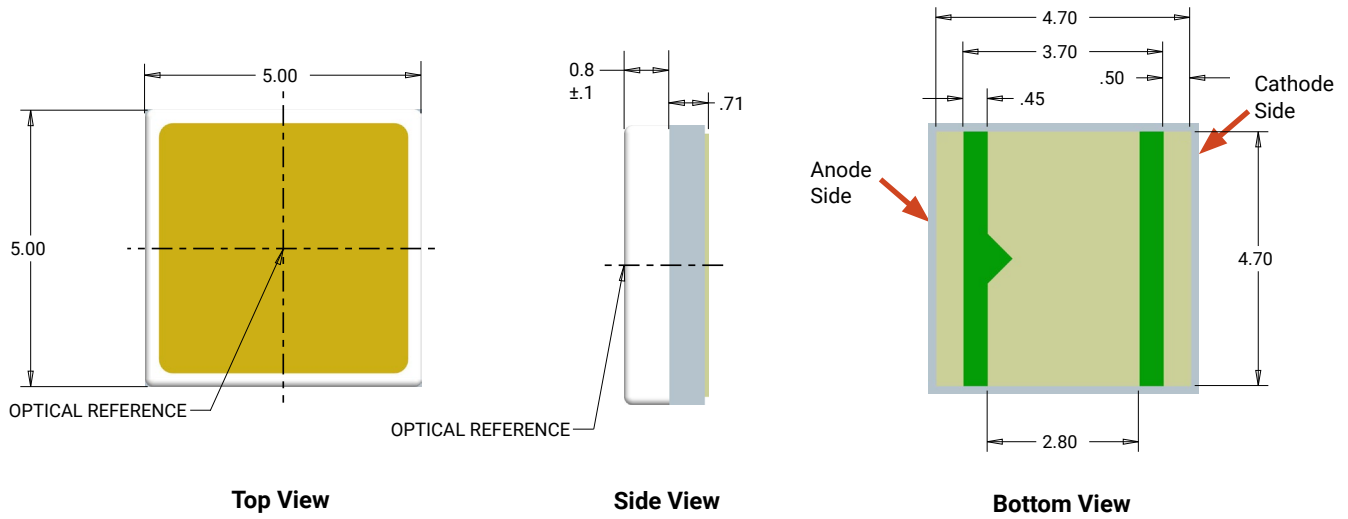

Top View

Side View

Bottom View

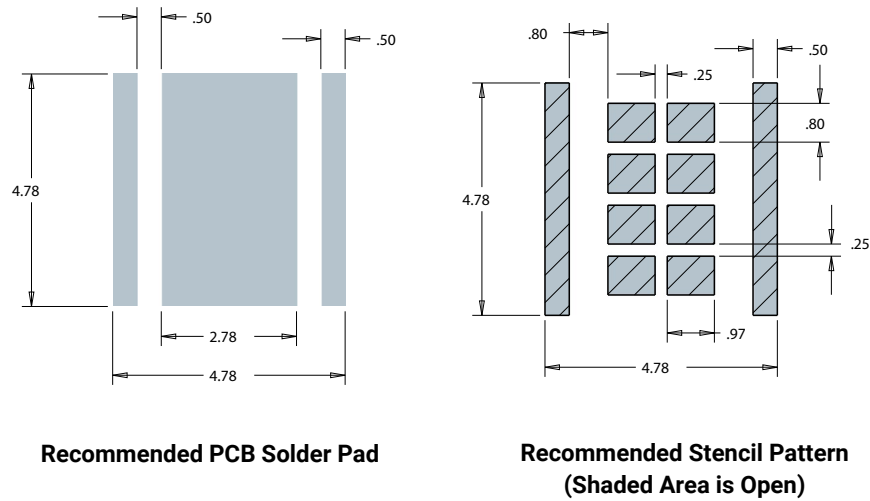

Recommended PCB Solder Pad

**Recommended Stencil Pattern
(Shaded Area is Open)**

TAPE AND REEL

All Cree carrier tapes conform to EIA-481D, Automated Component Handling Systems Standard.

All dimensions in mm [in].

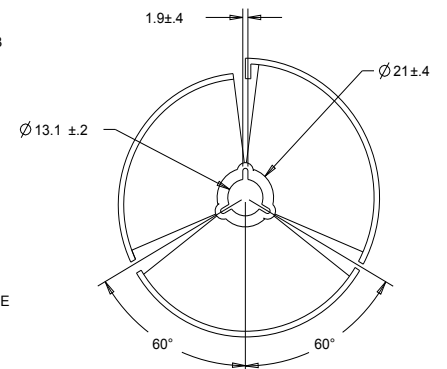
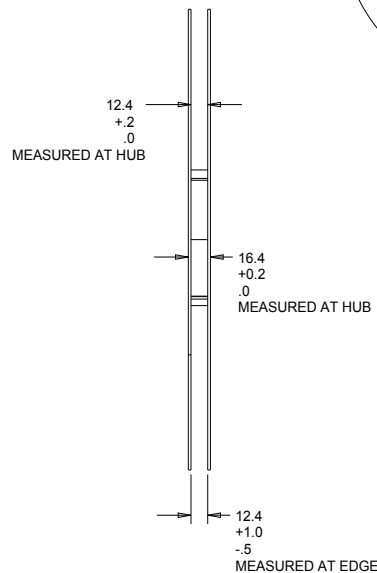
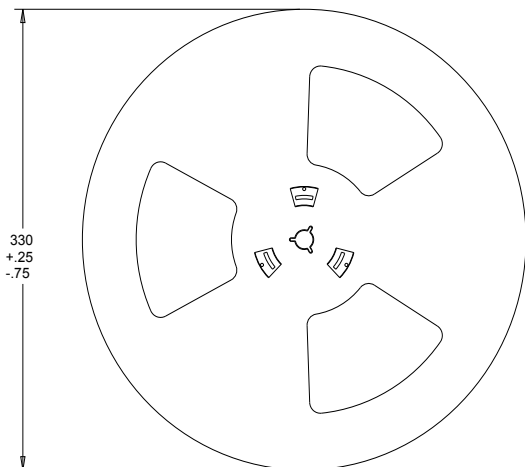
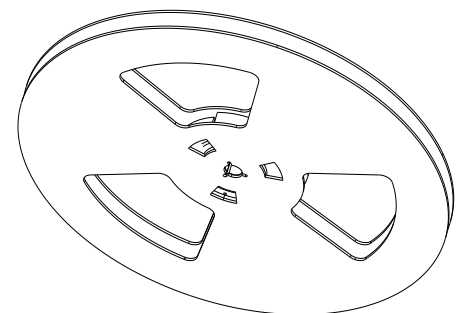
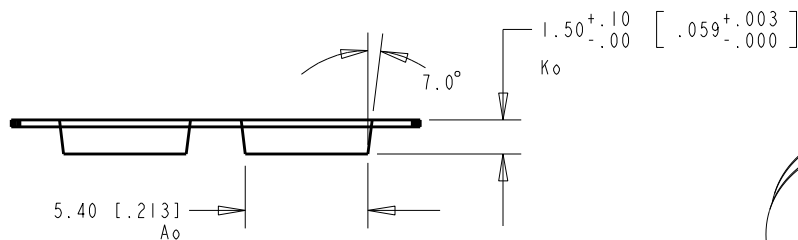
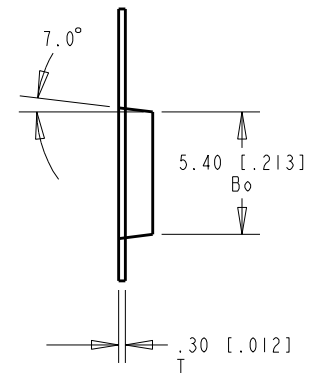
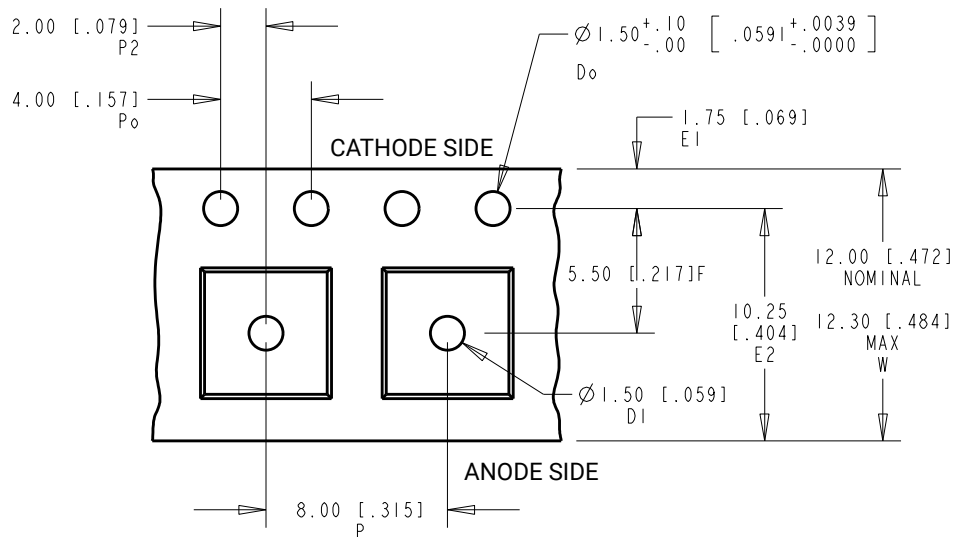

PACKAGING

Unpackaged Reel

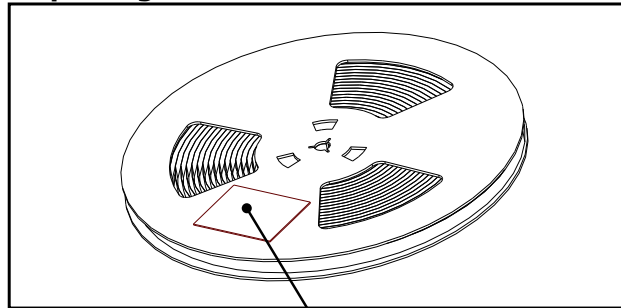

Label with Cree Bin Code,
Quantity, Reel ID

Packaged Reel

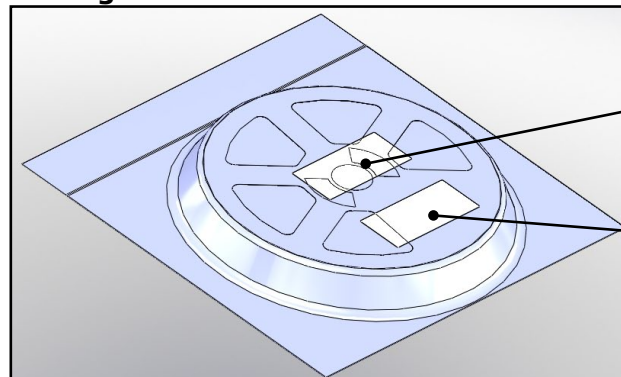

Label with Cree Order Code,
Quantity, Reel ID, PO #

Label with Cree Bin Code,
Quantity, Reel ID

Boxed Reel

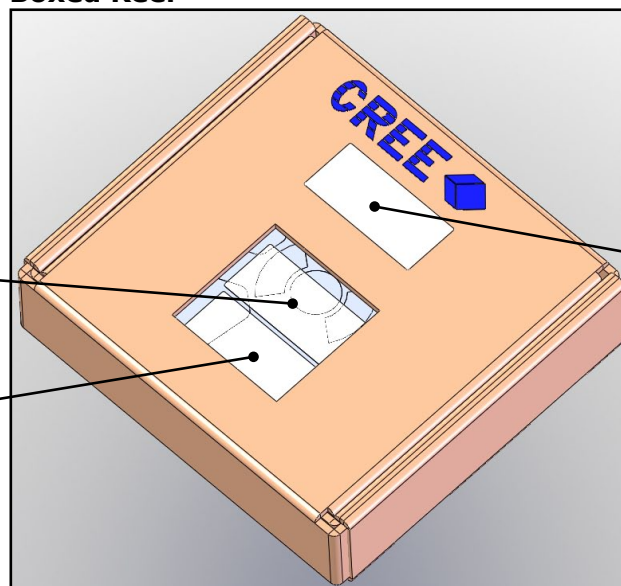

Label with Cree Order Code,
Quantity, Reel ID, PO #

Label with Cree Bin Code,
Quantity, Reel ID

Patent Label