

Flameproof Type Light Curtain **Type 4**

BSF4-AH80

Related Information

- General terms and conditions..... F-7
- Sensor selection guide P.497~
- Glossary of terms..... P.1455~
- General precautions P.1458~

- FIBER SENSORS
- LASER SENSORS
- PHOTOELECTRIC SENSORS
- MICRO PHOTOELECTRIC SENSORS
- AREA SENSORS
- LIGHT CURTAINS / SAFETY COMPONENTS**
- PRESSURE / FLOW SENSORS
- INDUCTIVE PROXIMITY SENSORS
- PARTICULAR USE SENSORS
- SENSOR OPTIONS
- SIMPLE WIRE-SAVING UNITS
- WIRE-SAVING SYSTEMS
- MEASUREMENT SENSORS
- STATIC ELECTRICITY PREVENTION DEVICES
- LASER MARKERS
- PLC
- HUMAN MACHINE INTERFACES
- ENERGY CONSUMPTION VISUALIZATION COMPONENTS
- FA COMPONENTS
- MACHINE VISION SYSTEMS
- UV CURING SYSTEMS



Control Category 4 PLe SIL3

panasonic.net/id/pidsx/global

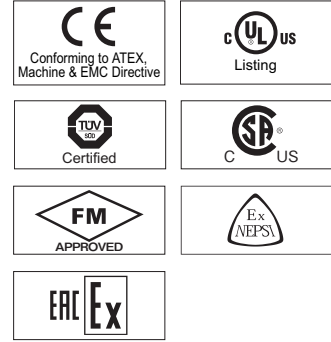

Product certified by China Certification Body
Certification No.GYJ05332X



Globally-compliant flameproof structure

Complies with worldwide flameproof standards

The compact light curtain **SF4-AH80** is built into a highly flameproof enclosure conforming to the IEC 61496 (Type 4). The light curtain can be safely used in any workplace throughout the world where flameproof performance is required.

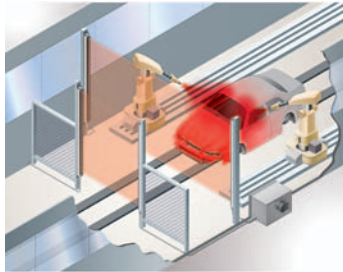

Ample protective height 1,595 mm 62.795 in

A single light curtain is sufficient for production lines with high working heights such as vehicle body spray-painting lines.



- Selection Guide
- Light Curtains
- Safety Components
- Optical Touch Switch
- Control Units
- Definition of Sensing Heights
- SF4B-C**
- SF4C**
- SF2C**
- SF4B**
- SF2B**
- BSF4-AH80**

Europe	Complies with flameproof structures (Exd II BT6) specified by IEC 60079, EN 60079-0, EN60079-1 and ATEX Directives (94/9/EC).
United States	Complies with flameproof structures (Class I Zone 1 AExd II BT6) specified by FM 3600 (ISA 12.22.01).
Canada	Complies with flameproof structures (Exd II BT6) specified by CAN/CSA-E79-0 (CAN/CSA-E79-1).
Russia	Complies with the Russian standard GOST R IEC 60079-0, GOST IEC 60079-1 which is based on the international standard.
China	Complies with China's standard GB 3836.1/2 (Exd II BT6) conforming to international standards.
Japan	Complies with technical standard (Exd II BT6) conforming to international standards.

Hazardous locations: Zone 1 location, Zone 2 location
Classification of gas or vapor, and Temperature classification: II BT6

Mounting bracket enables easy beam-axis alignment

The beam-axis alignment is easy since angle adjustment is possible with the enclosed rear mounting bracket.

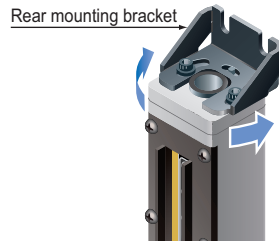

Less operating errors from extraneous light interference

A double-scanning method and retry processing are some unique new technology that help to avoid momentary interference from extraneous light coming from nearby equipment. A reduction in operating errors resulting from extraneous light interference can mean less frequent machinery stoppages and reduces the amount of time that a production line is not running.

Mutual interference is reduced without the need for interference prevention lines

No interference prevention lines are required between different items of equipment, so that sensors can be installed with greater flexibility.

Unaligned beam axes can be seen at a glance

The beam-axis alignment indicators are distributed on the light curtains in four sections. As the indicators of the sections whose beam channels are aligned light up in red, the user can easily verify which beam channel axes have become aligned. Once all beam channels have become aligned, the indicators light up in green.

When the upper half of all beam channel axes are aligned	The bottommost beam channel axis is correctly aligned
Upper two indicators: ON Lower two indicators: OFF	Indicator at bottommost blinks red
<p>Even though beam channels are only partially aligned, the user can determine which beam channels are aligned (Beam axes of two upper blocks are aligned / beam axes of two lower blocks are not aligned)</p>	<p>Blinking</p>

ORDER GUIDE

Light curtain

Type	Operating range (Note)	Model No.	Number of beam channels	Protective height (mm in)
20 mm 0.787 in beam pitch	0.3 to 6 m 0.984 to 19.685 ft	BSF4-AH80	80	1,595 62.795

Note: The operating range is the possible setting distance between the emitter and the receiver.

Control unit

Designation	Appearance	Model No.	Description
Slim type control unit		SF-C13 (Note)	For PNP / NPN equivalent output type light curtain. Compatible with Control Category 4. Use in a safe location.

Note: Refer to **SF-C10** series pages (P.643~) for details of **SF-C13**.

- FIBER SENSORS
- LASER SENSORS
- PHOTO-ELECTRIC SENSORS
- MICRO PHOTO-ELECTRIC SENSORS
- AREA SENSORS
- LIGHT CURTAINS / SAFETY COMPONENTS
- PRESSURE / FLOW SENSORS
- INDUCTIVE PROXIMITY SENSORS
- PARTICULAR USE SENSORS
- SENSOR OPTIONS
- SIMPLE WIRE-SAVING UNITS
- WIRE-SAVING SYSTEMS
- MEASUREMENT SENSORS
- STATIC ELECTRICITY PREVENTION DEVICES
- LASER MARKERS
- PLC
- HUMAN MACHINE INTERFACES
- ENERGY CONSUMPTION VISUALIZATION COMPONENTS
- FA COMPONENTS
- MACHINE VISION SYSTEMS
- UV CURING SYSTEMS
- Selection Guide
- Light Curtains
- Safety Components
- Optical Touch Switch
- Control Units
- Definition of Sensing Heights
- SF4B-C**
- SF4C**
- SF2C**
- SF4B**
- SF2B**
- BSF4-AH80**

SPECIFICATIONS

Model No.	BSF4-AH80	
Item		
Applicable flameproof standards	Europe: IEC 60079, EN 60079-0, EN60079-1, North America: FM 3600 (ISA.12.22.01), Canada: CAN/CSA-E79-0 (CAN/CSA-E79-1), Russia: GOST R IEC 60079-0, GOST IEC 60079-1, China: GB 3836.1/2, Japan: Technical standard conforming to international standards	
Flameproof capability	USA: Class I Zone 1 AExd II BT6, Europe / Canada / Russia / China / Japan: Exd II BT6	
Setup location	Hazardous locations such as Zone 1 or Zone 2 where "II BT6" gases or vapors may be present (Note 2)	
Applicable standards	ISO 13849-1 (Category 4, PL), EN ISO 13849-1 (Category 4, PL), IEC 61508-1 to 4 (SIL 3), EN 50178, EN 55011, EN 61000-6-2, EN 61496-1 (Type 4), IEC 61496-1/2 (Type 4), UL 61496-1/2 (Type 4), UL 1998, CAN/CSA-C22.2 No. 14 / No. 0.8	
Protective height	1,595 mm 62.795 in	
Beam pitch / Operating range	20 mm 0.787 in / 0.3 to 6 m 0.984 to 19.686 ft	
Min. sensing object	ø30 mm ø1.181 in opaque object	
Effective aperture angle	±2.5° or less [for an operating range exceeding 3 m 9.843 ft (conforming to IEC 61496-2 / UL 61496-2)]	
Supply voltage	24 V DC ±10 % Ripple P-P 10 % or less	
Current consumption	Emitter: 130 mA or less, Receiver: 125 mA or less	
Control outputs (OSSD1, OSSD2)	Semiconductor output (PNP output equivalent) 2 outputs <ul style="list-style-type: none"> Maximum source current: 200 mA Applied voltage: Same as supply voltage (between control output and +V) Residual voltage: 2.5 V or less (at 200 mA source current) 	
Operation mode / Protection circuit	ON when all beam channels are received, OFF when one or more beam channels are interrupted (OFF also in case of any malfunction in the light curtain or the synchronization signal) / Incorporated	
Response time	OFF response 11 ms or less, ON response 70 ms or less	
Auxiliary output (Non-safety output)	PNP open-collector transistor <ul style="list-style-type: none"> Maximum source current: 60 mA Applied voltage: Same as supply voltage (between auxiliary output and +V) Residual voltage: 2.5 V or less (at 60 mA source current) 	
Operation mode / Protection circuit	OFF when control outputs are ON, ON when control outputs are OFF / Incorporated	
Indicators	Emitter	Beam-axis alignment indicators: 2-color (Red / Green) LED × 4 (lights up in red when each beam channel receives light, blinks in red when the topmost or bottommost beam channel receives light, lights up in green when all beam channels receive light), Operation indicator (Note 3): 2-color (Red / Green) LED (lights up in red when control outputs are OFF, lights up in green when control outputs are ON), Emission halt / Emission amount control indicator (Note 4): 2-color (Orange / Green) LED (lights up in green during stable light incidence (incident light intensity approx. 115 % or more of control output operation level), off during unstable light incidence (incident light intensity approx. 100 % to 115 % of control output operation level) or when light is interrupted, blinks in orange when light emitting halted), Fault indicator: Yellow LED (lights up or blinks if a fault occurs in the light curtain)
	Receiver	Beam-axis alignment indicators: 2-color (Red / Green) LED × 4 (lights up in red when each beam channel receives light, blinks in red when the topmost or bottommost beam channel receives light, lights up in green when all beam channels receive light), OSSD indicator: 2-color (Red / Green) LED (lights up in red when control outputs are OFF, lights up in green when control outputs are ON), Blanking indicator: Orange LED (Note 4) (No use), Fault indicator: Yellow LED (lights up or blinks if a fault occurs in the light curtain)
Test input (emission halt) function	Incorporated	
Test input (emission halt input)	Emission: +9 V to Vs (sink current: 2 mA or less) (Note 5), Emission halt: Open, or 0 to +1.5 V	
Environmental resistance	Degree of protection	IP65 (IEC)
	Ambient temperature / Ambient humidity	-10 to +40 °C +14 to +104 °F (No dew condensation or icing allowed), Storage: -20 to +55 °C -4 to +131 °F / 45 to 85 % RH, Storage: 45 to 85 % RH
	Ambient illuminance	Incandescent light: 3,500 lx at the light-receiving face
	Dielectric strength voltage	1,000 V AC for one min. between all supply terminals connected together and light curtain grounding terminal (Note 6)
	Insulation resistance	20 MΩ, or more, with 500 V DC megger between all supply terminals connected together and light curtain grounding terminal (Note 6)
	Vibration resistance	10 to 55 Hz frequency, 0.35 mm 0.014 in amplitude in X, Y and Z directions for 20 times each
	Shock resistance	100 m/s ² acceleration (10 G approx.) with pulse width 16 ms in X, Y and Z directions for 1,000 times each
Altitude (Atmospheric pressure)	2,000 m 6561 ft or less (800 to 1,100 hPa)	
Emitting element	Infrared LED (Peak emission wavelength: 870 nm 0.034 mil)	
Material	Flameproof enclosure: Aluminum, Lid: Aluminum die-cast, Clear window: Glass, Window frame: Steel plate (Black chromate) Window packing: Chloroprene, Sensor mounting bracket: Steel plate (Black chromate), Cable: Oil-resistant PVC, Cable Gland: Brass (Nickel plated)	
Cable	6-core (0.3 mm ² × 4-core, 0.2 mm ² × 2-core) oil resistant shielded cable, 20 m 65.617 ft long	
Weight (Total of emitter and receiver)	Net weight: 44 kg approx.	
Accessories	Rear sensor mounting bracket: 1 set for emitter and receiver, Test rod: 1 pc. Gland adapter (Internal thread G 1/2): 2 pcs.	

Notes: 1) Where measurement conditions have not been specified precisely, the conditions used were an ambient temperature of +20 °C **+68 °F**.

2) Install the product in a location where it is less likely to suffer mechanical damage.

3) Since the color of the operation indicator changes according to the ON / OFF state of the control outputs (OSSD1, OSSD2), the operation indicator is marked as "OSSD" on the sensor.

4) The Handy-controller (**SF-HC**) (optional) cannot be used with this device, so that the emission amount control function and the blanking indicator function cannot be used. Furthermore, series connection is not possible.

5) Vs is the same value as the voltage of the used power supply to be used.

6) The built-in **SF4-AH80** light curtain that is used in this product has a surge absorber connected between the main body enclosure and the supply terminals to avoid faulty operation due to power surges. For this reason, the values for dielectric strength voltage and insulation resistance are given for the condition when the surge absorber has been removed.

I/O CIRCUIT AND WIRING DIAGRAMS

I/O circuit diagram

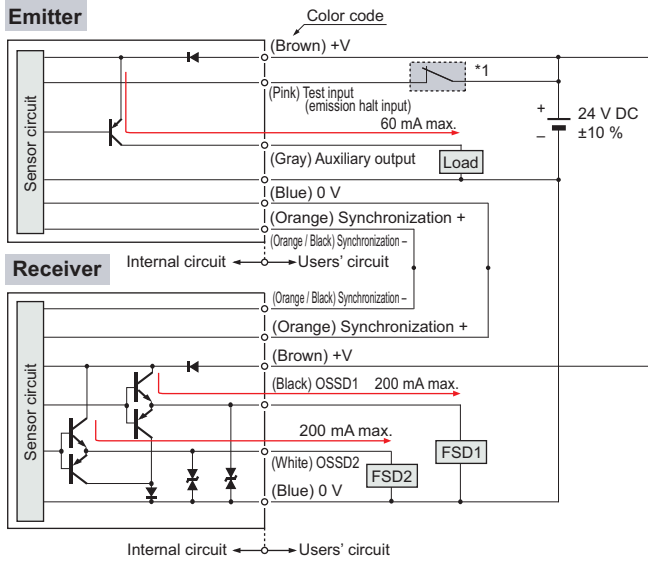

CAUTION
Use a safety relay unit or an equivalent safety control circuit for FSD.

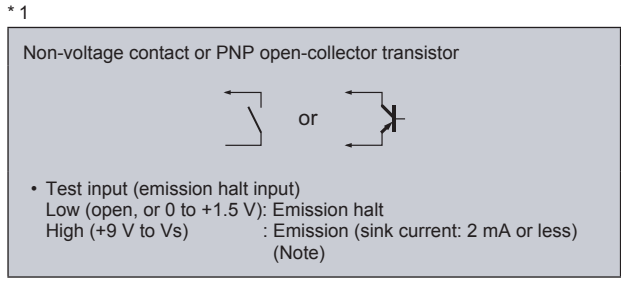

Note: Vs is same voltage as the voltage of the power supply to be used.

Wiring diagram of the SF-C13 (Control category 4)

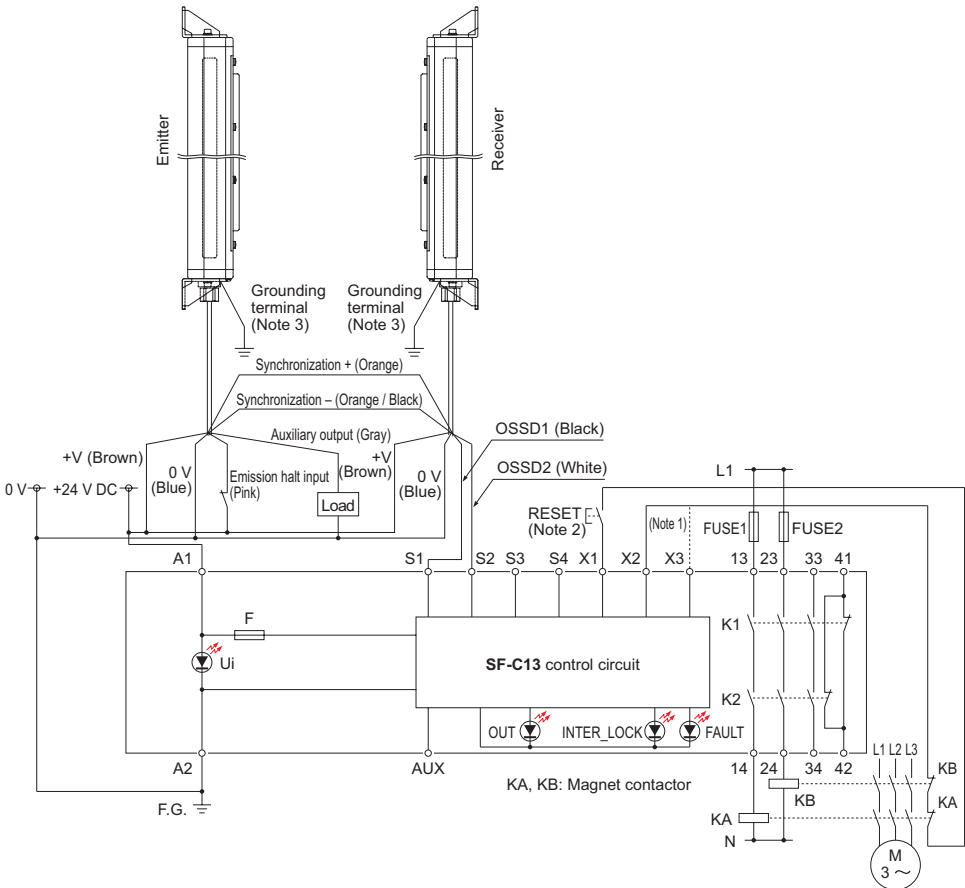

SF-C13 Terminal arrangement diagram

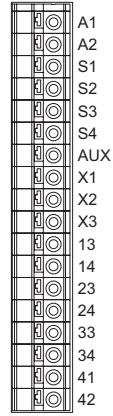

- Notes: 1) The above diagram is when using manual reset.
If automatic reset is used, disconnect the read from X2 and connect it to X3.
In this case, a reset (RESET) button is not needed.
2) Use a momentary-type switch for the reset (RESET) button.
3) Ground the grounding terminal of **BSF4-AH80** without fail.

FIBER SENSORS

LASER SENSORS

PHOTO-ELECTRIC SENSORS

MICRO PHOTO-ELECTRIC SENSORS

AREA SENSORS

LIGHT CURTAINS / SAFETY COMPONENTS

PRESSURE / FLOW SENSORS

INDUCTIVE PROXIMITY SENSORS

PARTICULAR USE SENSORS

SENSOR OPTIONS

SAVE WIRE-SAVING UNITS

WIRE-SAVING SYSTEMS

MEASUREMENT SENSORS

STATIC ELECTRICITY PREVENTION DEVICES

LASER MARKERS

PLC

HUMAN MACHINE INTERFACES

ENERGY CONSUMPTION VISUALIZATION COMPONENTS

FA COMPONENTS

MACHINE VISION SYSTEMS

UV CURING SYSTEMS

Selection Guide

Light Curtains

Safety Components

Optical Touch Switch

Control Units

Definition of Sensing Heights

SF4B-C

SF4C

SF2C

SF4B

SF2B

BSF4-AH80

PRECAUTIONS FOR PROPER USE

Refer to p.1458~ for general precautions.



- Do not utilize this light curtain in “PSDI Mode”, in which the light curtain is utilized as an activator for machinery.
- To use this product in the U.S.A., refer to OSHA 1910. 212 and OSHA 1910. 217 for installation, and in Europe, refer to EN 999 as well. Observe your national and local requirements before installing this product.

- This catalog is a guide to select a suitable product. Be sure to read the instruction manual attached to the product prior to its use.

Cautions for explosion-protection



This product has a flameproof structure and explosionproof performance that can only be ensured when the product meets all of the specified conditions and specifications. Failure to observe any of them will result in the loss of the explosionproof performance.

- Use flameproof electric appliances that are compatible with hazardous locations (locations where an explosive atmosphere of gas or vapor may exist).
- Make sure that the power supply is off while wiring. Otherwise, electric shock may result.
- Never modify or repair the product yourself. Failure to follow this instruction may result in an explosion or ignition.
- Protect the cables, or external conductors, against possible external damage by passing them through a sufficiently strong metallic tube or by other means.
- Ground the grounding terminal without fail. Failure to follow this instruction may result in an explosion or ignition.
- Do not open the lid of the flameproof enclosure, and do not remove the window frame fixtures of the enclosure. Failure to follow this instruction may result in an explosion or ignition.
- The product can be used in Zone 1 or Zone 2 areas where explosive gases may exist and flameproof appliances in groups IIA and IIB and temperature classifications of T1 to T6 can be used. Never install in locations which are classified as “0” (Zone 0).
- For the classification of hazardous locations and flameproof electric appliances, see each country’s electric equipment construction work principles and other related laws and regulations.
- If the wiring is expected to be subjected to electromagnetic or electrostatic induction from the general circuits, separately protect it with a metallic tube or duct.

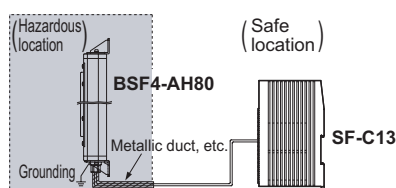

- Install the product in a location where it is less likely to suffer mechanical damage.

Mounting

- When mounting the light curtain, secure it in place using four M10 bolts.
- The cable lead-in port is threaded for wiring protective tube or conduit (NPT 1/2). Using a steel wire tube etc., if necessary, screw a tube into the port at least five complete threads.
- After beam alignment, tighten the hexagon-socket-head bolts for adjusting mounting angle for fixing. The recommended tightening torque is 1.5 to 1.7 N·m. (The hexagon-socket-head bolts for adjusting mounting angle are on top and bottom surfaces of the emitter and receiver.)

Grounding

- Ground the external grounding terminal on the flameproof enclosure to keep the grounding resistance at or below 100 Ω.
- For grounding, use an electric wire with equivalent or higher insulation performance to a 600 V polyvinyl-insulated electric wire, and of a thickness ensuring safe carrying of the expected maximum ground current.

Others

- Use the product according to the specifications of this product. Failure to follow this instruction may result in electric shock, injuries, or damage to the product.
- Unpack the product with the right side facing up. If you do not follow this instruction, you may get injured.
- Do not touch any terminals when measuring the insulation resistance. Failure to follow this instruction may result in electric shock.
- If there is something abnormal with the product, immediately turn OFF the product. Otherwise, electric shock, injuries, or a fire may result.
- Before measuring the insulation resistance, confirm that there is no explosive atmosphere of gases or vapor around. Failure to follow this instruction may result in an explosion or ignition.

FIBER SENSORS

LASER SENSORS

PHOTO-ELECTRIC SENSORS

MICRO PHOTO-ELECTRIC SENSORS

AREA SENSORS

LIGHT CURTAINS SAFETY COMPONENTS

PRESSURE / FLOW SENSORS

INDUCTIVE PROXIMITY SENSORS

PARTICULAR USE SENSORS

SENSOR OPTIONS

SIMPLE WIRE-SAVING UNITS

WIRE-SAVING SYSTEMS

MEASUREMENT SENSORS

STATIC ELECTRICITY PREVENTION DEVICES

LASER MARKERS

PLC

HUMAN MACHINE INTERFACES

ENERGY CONSUMPTION VISUALIZATION COMPONENTS

FA COMPONENTS

MACHINE VISION SYSTEMS

UV CURING SYSTEMS

Selection Guide

Light Curtains

Safety Components

Optical Touch Switch

Control Units

Definition of Sensing Heights

SF4B-C

SF4C

SF2C

SF4B

SF2B

BSF4-AH80

