



Touch Display with TFT Display

User manual

UM EN TD 1030T

User manual

Touch Display with TFT Display

2013-05-07

Designation: UM EN TD 1030T

Revision: 00

Order No.: —

This user manual is valid for:

Designation
TD 1030T

Order No.
2701257

How to contact us

Internet

Up-to-date information on Phoenix Contact products and our Terms and Conditions can be found on the Internet at:

phoenixcontact.com

Make sure you always use the latest documentation.

It can be downloaded at:

phoenixcontact.net/catalog

Subsidiaries

If there are any problems that cannot be solved using the documentation, please contact your Phoenix Contact subsidiary.

Subsidiary contact information is available at phoenixcontact.com.

Published by

PHOENIX CONTACT GmbH & Co. KG

Flachsmarktstraße 8

32825 Blomberg

GERMANY

Should you have any suggestions or recommendations for improvement of the contents and layout of our manuals, please send your comments to

tecdoc@phoenixcontact.com

General terms and conditions of use for technical documentation

Phoenix Contact reserves the right to alter, correct, and/or improve the technical documentation and the products described in the technical documentation at its own discretion and without giving prior notice, insofar as this is reasonable for the user. The same applies to any technical changes that serve the purpose of technical progress.

The receipt of technical documentation (in particular user documentation) does not constitute any further duty on the part of Phoenix Contact to furnish information on modifications to products and/or technical documentation. You are responsible to verify the suitability and intended use of the products in your specific application, in particular with regard to observing the applicable standards and regulations. All information made available in the technical data is supplied without any accompanying guarantee, whether expressly mentioned, implied or tacitly assumed.

In general, the provisions of the current standard Terms and Conditions of Phoenix Contact apply exclusively, in particular as concerns any warranty liability.

This manual, including all illustrations contained herein, is copyright protected. Any changes to the contents or the publication of extracts of this document is prohibited.

Phoenix Contact reserves the right to register its own intellectual property rights for the product identifications of Phoenix Contact products that are used here. Registration of such intellectual property rights by third parties is prohibited.

Other product identifications may be afforded legal protection, even where they may not be indicated as such.

Table of Contents

1	Important Notes	7
1.1	Symbols	7
1.2	Safety Notes	7
1.3	Intended Use	8
1.4	Target Group	8
2	Installation and Commissioning	9
2.1	Unpacking the Device.....	9
2.2	Mounting the Device.....	10
2.2.1	Front Panel Dimensions	11
2.2.2	Mounting Cutout	12
2.2.3	Side View, Mounting Depth	13
2.3	Connecting the Device	14
2.3.1	Supply Voltage	14
2.4	Switching On	16
2.4.1	Normal Mode	16
2.4.2	Settings Mode	17
2.5	Visualization with WebVisit	20
2.6	Identification	22
3	Control and Display Elements	23
3.1	Touch Screen	23
3.2	Push-Button „Default“	23
3.3	Display.....	23
4	Interfaces of the Device	25
4.1	Ethernet (X2)	26
4.1.1	Pin Assignment	26
4.1.2	Cable	26
4.1.3	Diagnostics	27
5	Maintenance and Servicing	29
5.1	Front Panel.....	29
5.2	Fuse	29
5.3	Update.....	30
6	Technical Data	31

1 Important Notes

1.1 Symbols

The symbols in this manual are used to draw your attention on notes and dangers.



This is the safety alert symbol. It is used to alert you to potential personal injury hazards. Obey all safety messages that follow this symbol to avoid possible injury or death.

There are three different categories of personal injury that are indicated with a signal word.



DANGER

This indicates a hazardous situation which, if not avoided, will result in death or serious injury.



WARNING

This indicates a hazardous situation which, if not avoided, could result in death or serious injury.



CAUTION

This indicates a hazardous situation which, if not avoided, could result in minor or moderate injury.



NOTICE

This symbol together with the signal word NOTE and the accompanying text alert the reader to a situation which may cause damage or malfunction to the device, hardware/software, or surrounding property.



This symbol and the accompanying text provide the reader with additional information or refer to detailed sources of information.

1.2 Safety Notes

- Read this manual carefully before using the operating device. Keep this manual in a place where it is always accessible to all users.
- Proper transportation, handling and storage, placement and installation of this product are prerequisites for its subsequent flawless and safe operation.
- This user manual contains the most important information for the safe operation of the device.
- The user manual, in particular the safety notes, must be observed by all personnel working with the device.
- Observe the accident prevention rules and regulations that apply to the operating site.
- Installation and operation must only be carried out by qualified and trained personnel.

1.3 Intended Use

- The device is designed for use in the industry.
- The device is state-of-the art and has been built to the latest standard safety requirements. However, dangerous situations or damage to the machine itself or other property can arise from the use of this device.
- The device fulfills the requirements of the EMC directives and harmonized European standards. Any modifications to the system can influence the EMC behavior.



NOTICE: Radio Interference

This is a class A device. This device may cause radio interference in residential areas. In this case, the user may be required to introduce appropriate countermeasures, and to bear the cost of same.

1.4 Target Group

The use of products described in this manual is oriented exclusively to:

- Qualified electricians or persons instructed by them, who are familiar with applicable standards and other regulations regarding electrical engineering and, in particular, the relevant safety concepts.
- Qualified application programmers and software engineers, who are familiar with the safety concepts of automation technology and applicable standards.

2 Installation and Commissioning

2.1 Unpacking the Device

Unpack all parts carefully and check the contents for any visible damage in transit. Also check whether the shipment matches the specifications on your delivery note.

If you notice damages in transit or discrepancies, please contact Phoenix Contact immediately.

2.2 Mounting the Device



NOTICE: Damage

When the operating device is installed horizontally, please note that additional sources of heat beneath the operating device may result in heat accumulation. Make sure to allow sufficient heat dissipation! Please observe the permissible temperature range specified in the technical data of the user manual when operating the device.



NOTICE: Damage

In order to ensure the degree of protection specified in the technical data, always make sure that the seal lies flat against the mounting surface and the threaded pins of the mounting brackets are tightened uniformly to a maximum torque of 1 Nm.

The device enables quick and easy mounting from the rear. A panel thickness of 1 mm (0.039" to 0.236") is permitted for proper mounting.

1. Cut the mounting cutout in the housing for the device size to be installed.
2. Push the housing seal over the back of the device until the seal is against the front panel.
3. Push the device through the mounting cutout from the front.

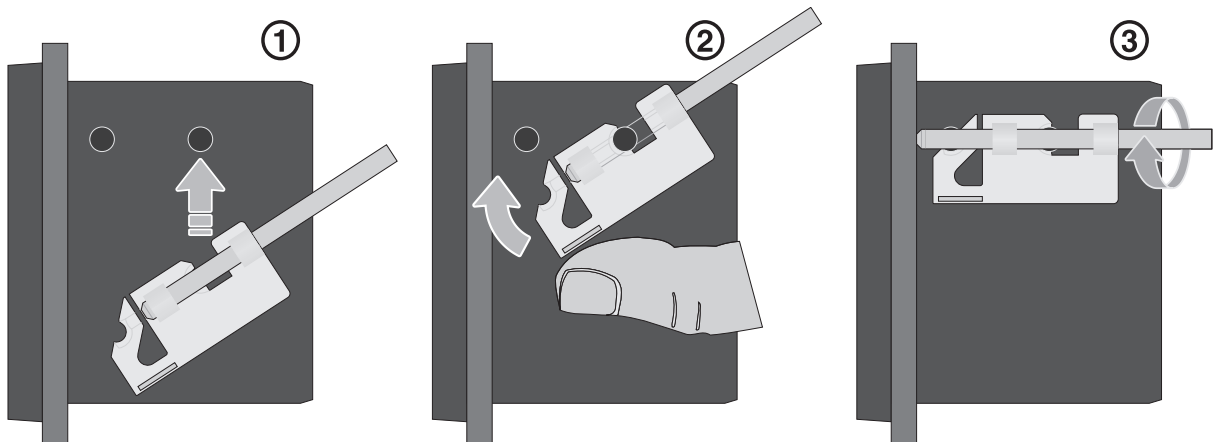

Figure 2-1 Mounting the device using a mounting bracket

4. Push the mounting bracket into the provided mounting cone on the housing (1).
5. Press the mounting bracket against the second mounting cone until it latches fully into place (2).
6. Secure the second mounting bracket in the same way.
7. Secure the device using the threaded pins (3).

2.2.1 Front Panel Dimensions

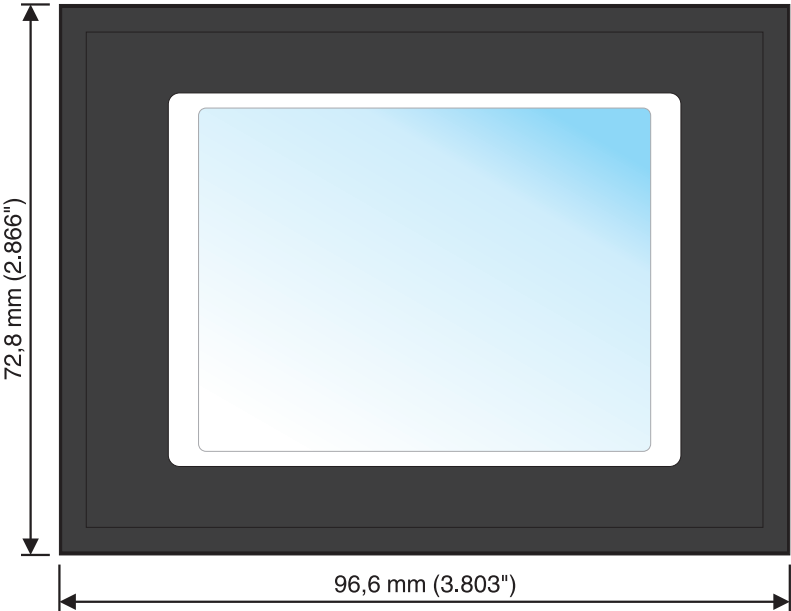

Figure 2-2 TD 1030T

2.2.2 Mounting Cutout

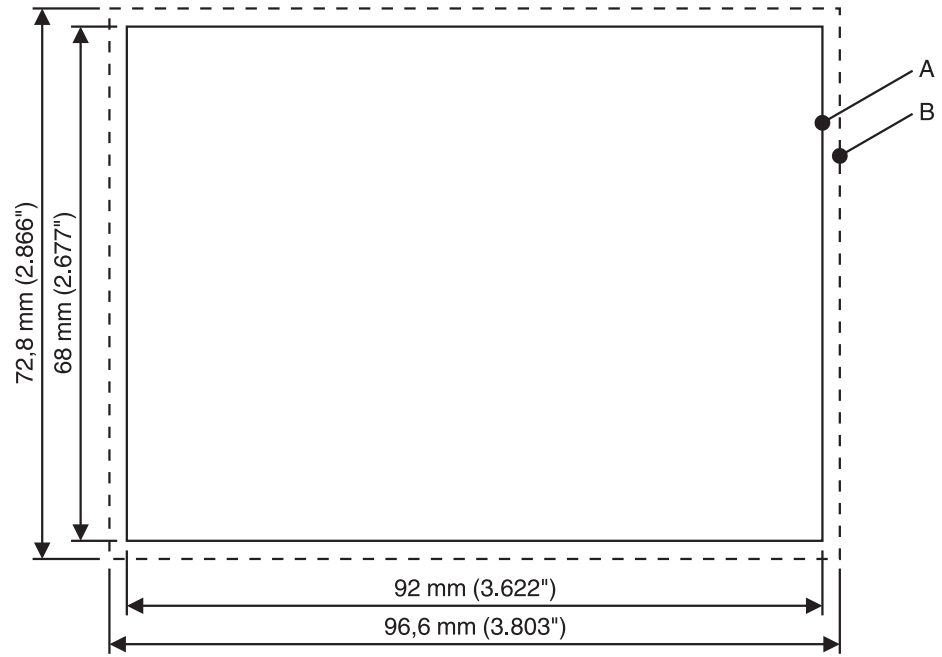

Figure 2-3 TD 1030T

- A** Mounting Cutout
- B** Front Panel

2.2.3 Side View, Mounting Depth

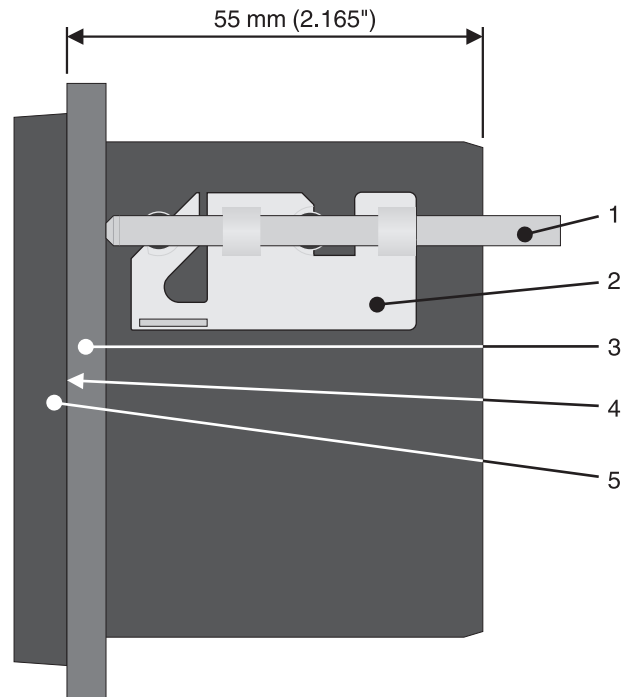

Figure 2-4 TD 1030T

- 1 Threaded Pin
- 2 Mounting Bracket
- 3 Mounting Surface Thickness 1 mm to 6 mm
- 4 Circumferential Seal
- 5 Front Panel

2.3 Connecting the Device

2.3.1 Supply Voltage

The supply voltage is supplied via pin strip X1. A suitable socket strip is supplied.
Refer to the technical data for the permissible supply voltage of the operating device.



The device has reverse polarity protection. In case of wrong polarity, the device will not operate.



This is a protection class I device. For safe operation, safety extra-low voltage (SELV) in accordance with DIN EN 61131 must be used for the supply voltage.

Connector in the operating device: 3 pin pin strip

Table 2-1 Pin assignment supply voltage

Pin	Designation	Function
1		Noiseless ground / functional earth ground (FE)
2	0 V	Supply voltage 0 V (GND)
3	24 VDC	Supply voltage 24 VDC



NOTICE: Damage

Cables with finely stranded conductors with a minimum cross-section of 0.75 mm² (18 AWG) and a maximum cross-section of 2.5 mm² (14 AWG) must be used for the supply voltage.

You must adhere to the following torques at the connector:

Screw connection of terminal blocks: 0.22 Nm (minimal) to 0.25 Nm (maximum)

Screw flange: 0.3 Nm (maximum)



DANGER: Hazardous voltages

Hazardous voltages can exist inside electrical installations that can pose a danger to humans. Coming in contact with live parts may result in electric shock!

Use the following procedure to connect the device to the supply voltage:

- Strip approx. 30 mm (1.181") off the outer cable sheath and approx. 5 mm (0.197") off the wires.

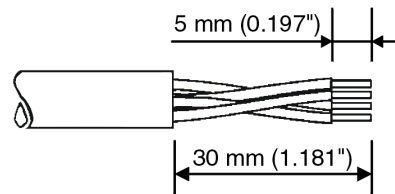

Figure 2-5 Preparing the cable

- Fit the wires with wire end ferrules and connect the wires to the socket strip.
- Plug the socket strip onto pin strip X1.

4. Secure the socket strip in place with a screw-type locking to prevent it from slipping out.

2.4 Switching On

The operating device allows you to make changes to the configuration at start procedure.

The operating panel has two operating modes:

- Normal (no button pressed)
- Settings (button **Settings** was pressed)

2.4.1 Normal Mode

The defined start URL is opened.

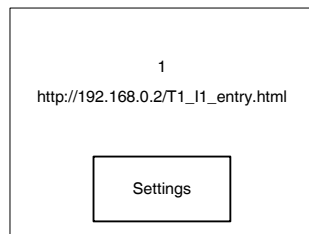

Figure 2-6 Display after startup



The operating device is compatible to Phoenix Contact controllers of type ILC 1xx, ILC 3xx and RFC 47x only.



Please, note that the device is accessible over the Ethernet only after assignment of an IP address to the Ethernet.
In the delivery State, Host-IP, Device IP and Subnet Mask are configured with a value of 0.0.0.0. This setting displays the message „Network Settings incomplete“. Change the settings to your network configuration.

2.4.2 Settings Mode

If you press the **Settings** button during startup phase, the settings screen starts.

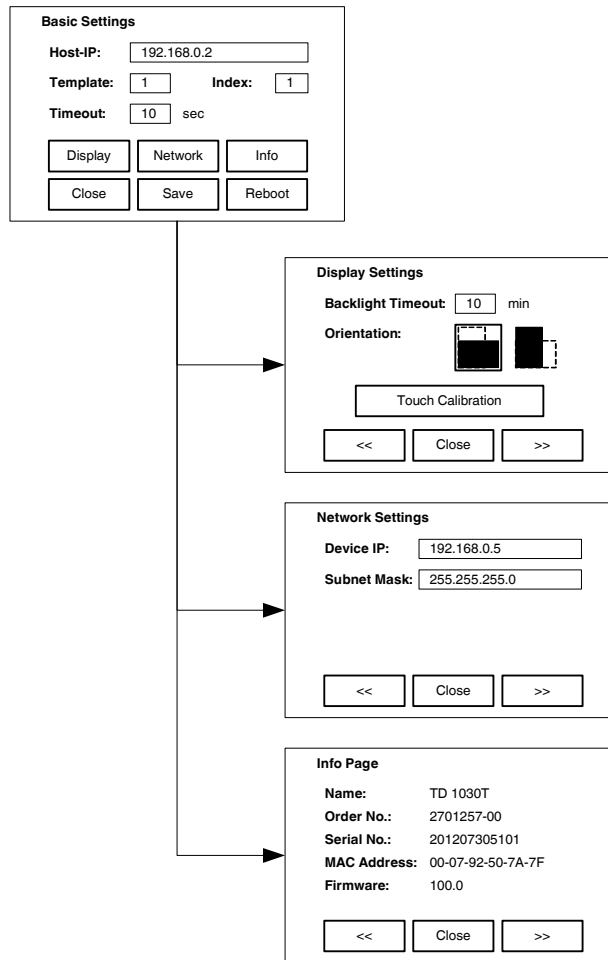

Figure 2-7 Settings

2.4.2.1 Basic Settings

Basic Settings, Host-IP:

The ip address of the control.

Basic Settings, Template:

The specified template is called on startup.

Basic Settings, Index:

The template is called with the specified index on startup.



The syntax of the requested URL from the web server, is „**xxx.xxx.xxx.xxx/Ty_Iz_entry.html**“. Host-IP (xxx.xxx.xxx.xxx), Template (y) and Index (z) must be known to invoke an application.

Example: The following URL is generated for the Host-IP „192.168.0.2“ with Template „2“ and the Index „1“: „http://192.168.0.2/T2_I1_entry.html“.

Basic Settings, Timeout:

The indicated start URL is called after the defined time in seconds.

Basic Settings, Close:

The **Basic Settings** page is closed.

Basic Settings, Save:

The settings are saved.

Basic Settings, Reboot:

The operating device will restart.

2.4.2.2 Display Settings

Display Settings, Backlight Timeout:

The brightness of the backlight is switched off after the defined time (minutes). A value of "0" disables the switching off.

Display Settings, Touch Calibration:

The touch calibration is started. After calibration, the values are automatically stored.

2.4.2.3 Network Settings

Network Settings, Device IP:

The ip address of the operating device.

Network Settings, Subnet Mask:

The subnet mask of the operating device.

2.4.2.4 Info Page

The following information is displayed:

Device name, article number, serial number, MAC address and firmware version.

2.4.2.5 Default values

The following default settings are configured in the Settings:

Table 2-2 Default values

Menu item	Setting	Default value	Comment
Basic Settings	Host-IP	0.0.0.0	
	Template	1	
	Index	1	
	Timeout	10	10 seconds

Table 2-2 Default values

Menu item	Setting	Default value	Comment
Display	Backlight Timeout	10	10 minutes
	Orientation	Landscape	
Network	Device IP	0.0.0.0	
	Subnet Mask	0.0.0.0	

2.5 Visualization with WebVisit

The operating device (WebClient) can visualize operating conditions using the built-in browser (Nanobrowser). Not all functions are supported unlike to Web panels or the Microbrowser if WebVisit is used as an editor. When creating or editing pages with WebVisit the following restrictions must be observed therefore:

Project size (without JAR file) Maximum of 256 kByte



The Nanobrowser loads all project files (*.html, *.tcr, *.teq, *.csv, *.fnt, etc.) from the webserver into the memory of the operating device. Keep in mind that projects does not run if these exceed the free available space of the operating device.

Number of pages 15 (maximum)

Number of objects per page 64 (maximum)

Supported objects Standard objects from the WebVisit painter gallery

Displayable colours 4 (simultaneously) displayable colors from the 16-bit color palette



Note that transparent pixels of an image will reduce the number of colors that can be displayed at the same time.

Supported graphics formats BMP, GIF, PNG



Compressed images (GIF, PNG) are uncompressed at runtime. As a result, additional space is required. If no additional space is available, the graphic is not displayed or the project does not run.

Supported animations Color change, bar graph, X-Y motion, showing and hiding

Macros No support for trend indicator, alarm lists; file viewer and IGraphic painter

Character set Arial: Latin and Western European basic character set
Arial MS Unicode: Cyrillic character set
No support of Arab and Asian character sets

Character length of filenames Maximum of 64

Character length of object names Maximum of 32 (applies to objects of the type CONTAINER, PPO und HTML TAG)

Character length of variables ASCII-format (default): Maximum of 64
Unicode-format: Maximum of 32

Font size Normal: 10, 12, 14
Bold: 12, 14



If you want to use additional fonts, you have to use the type "HTML tag" and turn on the option „Generate font files“ in the project settings of WebVisit. After you create the project, you must transfer the WebVisit-generated font files (.fnt) to the web server. The font files are stored by WebVisit in the following format: Arial_X_Y.fnt
The following values are possible for X: 0 = Normal; 1 = Bold; 2 = Italic
Y corresponds to the font size.
The file name must not be changed.



The following FNT files are available for download in our download area:
Font sizes at normal presentation: 8, 10, 12, 14, 16, 18, 20, 24, 28, 36, 48, 72
Font sizes at bold / italic presentation: 8, 10, 12, 14, 16, 18, 20, 24, 28

2.6 Identification

The operating device can be identified using the nameplate.

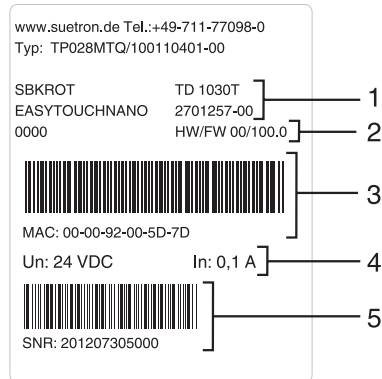

Figure 2-8 Nameplate (example)

- 1 Device Type, Article Number
- 2 Hardware- / Firmware Version (Version on Delivery)
- 3 MAC Address
- 4 Voltage and Current
- 5 Serial Number

3 Control and Display Elements

3.1 Touch Screen

The device is equipped with a resistive 4 wire touch screen. You operate the device using this touch screen.

**NOTICE: Damage**

Pointed or sharp objects, such as pens or fingernails, can lead to irreparable damages of the touch screen. Exclusively therefore use the fingertips or the aids indicated in the technical data for the operation.

**NOTICE: Damage**

To protect the touch screen you can use special protection foils. You receive corresponding protection foils directly from Phoenix Contact.

3.2 Push-Button „Default“

The push-button "Default" is attached to the back of the operating device. With this push-button you can reset the control unit to the factory settings. All user settings are overwritten by factory defaults and the calibrating data deleted. To reset the operating device, proceed as follows:

1. Disconnect the operating device from the supply voltage.
2. Press and hold the push-button (see Chapter "Push-Button „Default“" on page 3-23) on the rear of the operating device with a suitable tool (for example a pencil).
3. Connect the operating device to the supply voltage again while you hold the push-button down.
4. Perform a calibration of the touch screen.
5. Configure your user-specific settings in the **Settings** menu.

3.3 Display

**DANGER: Toxic**

If the display is damaged, avoid touching, swallowing or breathing in the liquids or gases which may leak out!

**DANGER: Corrosive**

If the display is damaged, avoid touching, swallowing or breathing in the liquids or gases which may leak out!

The operating device is equipped with a TFT display.

4 Interfaces of the Device

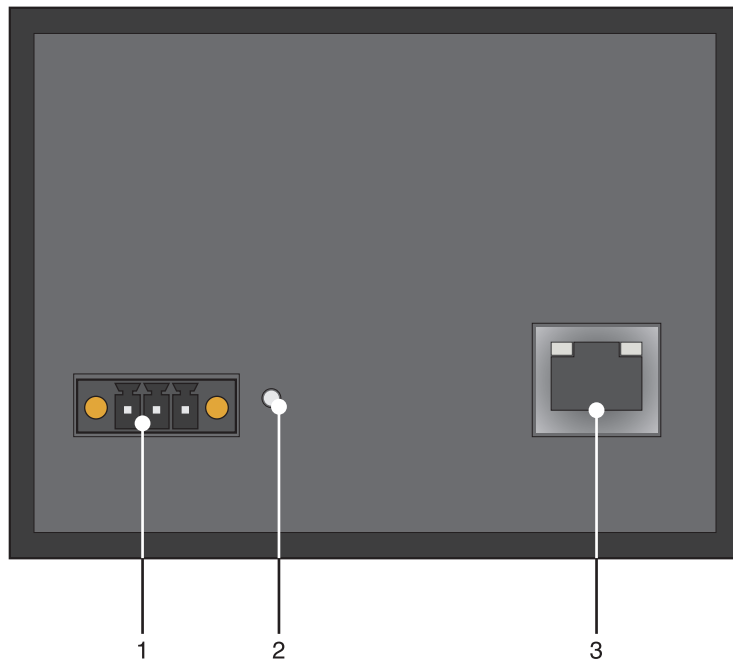

Figure 4-1 Rear view

- 1 Connector X1 (Supply Voltage)
- 2 Push-button „Default“
- 3 Female Connector X2 (Ethernet)

4.1 Ethernet (X2)

A 10/100Base-T Ethernet interface is located at the operating device.

4.1.1 Pin Assignment

Connector in the operating device: RJ45 female connector.

Table 4-1 Assignment of the Ethernet interface

Pin	Designation	Function
1	Tx+	Transmitted Data, Positive Polarity
2	Tx-	Transmitted Data, Negative Polarity
3	Rx+	Received Data, Positive Polarity
4	n.c.	Not Connected
5	n.c.	Not Connected
6	Rx-	Received Data, Negative Polarity
7	n.c.	Not Connected
8	n.c.	Not Connected

4.1.2 Cable

**NOTICE**

Use a twisted pair cable of category 5 (CAT 5). The maximum cable length is 100 m (328.084 feet).



See the IEEE 802.3 standard for further information.

4.1.3 Diagnostics

Ethernet diagnostics LEDs are located at the operating device.

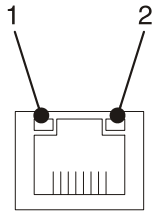

Figure 4-2 Position of the ethernet diagnostics LEDs

Table 4-2 Ethernet diagnostics LEDs

LED	Color	State	Designation	Function
1	Green	On	ACT/LNK	Connected
		Flashing		Sending / receiving ethernet data telegram
2	Yellow	On	SPD 10/100	Operation in 100 MBit/s mode
		Off		Operation in 10 MBit/s mode or disconnected

5 Maintenance and Servicing

5.1 Front Panel

Only use a damp cloth to remove any dirt from the front panel.

5.2 Fuse

**NOTICE: Damage**

The semiconductor fuse cannot be replaced!

A semiconductor fuse is used to protect the device. Once the fuse has been tripped, the device must be disconnected from the supply voltage to allow the semiconductor fuse to regenerate. At an ambient temperature of 20 °C (68 °F), the regeneration takes approximately 20 seconds. The higher the ambient temperature, the longer the regeneration takes.

5.3 Update

To update the firmware of the operating device, proceed as follows:

1. Extract the file „NanoBrowser_Vxxx.x.zip“.
2. Upload the file „NanoBrowser_Vxxx.x.img“ and „version.ini“ to the control.



The file „version.ini“ specifies the valid firmware version for the operating device. The operating device is updated with this version, even if this is an older version. You can determine the current firmware version in the settings menu at the info item.

-
3. Turn on the operating device.

The update is performed after the time has expired.

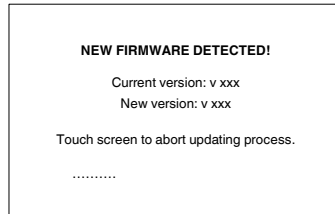

To cancel the update operation, press the touch screen.

A message is displayed after the successful update:

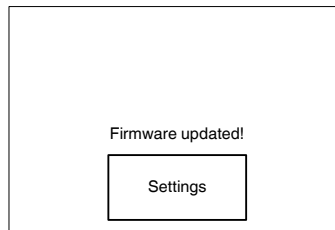

4. Press the **Settings** button and check your settings.
5. Press the **Reboot** button to restart the operating device.

6 Technical Data

Display

Size (diagonal) in cm (inch)	7.11 (2.8)
Type	TFT (color)
Resolution (pixels)	320 x 240
Colors	4
Reading angle (vertical / horizontal)	50° / 65°
Half-life backlighting	40.000 h at 25 °C (77 °F) environmental temperature
Brightness in cd/m ²	280
Display area (H x W) in mm (Inch)	57.6 x 43.2 (2.267 x 1.7)

Touchscreen

Type	Analog resistive, 4 wire technology
Activation force	15 g (Standard) With R8 silicon rubber
Durability	No damages to the film surface have occurred after 1 million strokes under the following conditions: Keystroke element: R8 silicon rubber Keystroke load: 250 g Keystroke frequency: 2 Hz

Ethernet

X2 Ethernet	10/100Base-T
-------------	--------------

Central Processing Unit

Central processing unit	ARM Cortex™-M3
Clock frequency	120 MHz

Memory

SRAM	96 KByte
Flash	512 KByte

Connection Method

Female and male connector strips Phoenix MINI COMBICON, 3 pin
RJ45 female connector

Environmental Conditions

Temperature during operation	0 °C to 50 °C (32 °F to 122 °F)
Temperature during storage, transport	- 25 °C to + 70 °C (-13°F to + 158°F)

Environmental Conditions

Relative air humidity for operation and storage 20 % to 85 %, no condensation

Application area Degree of pollution 1, overvoltage category III

UV radiation No direct solar radiation

Standards and Guidelines

Interference immunity EN 61000-4-2
EN 61000-4-3
EN 61000-4-4
EN 61000-4-5
EN 61000-4-6
EN 61000-6-2

Emitted interference EN 61000-6-4
EN 50011 limit class value A
EN 50022 limit class value A

Equipment requirements EN 61131

Storage and transportation EN 61131 part 2

Power supply EN 61131 part 2

Electromagnetic compatibility 2004/108/EG

Degree of protection EN 60529

Impact load, shocks EN 60068 part 2-27

Sinusoidal vibrations EN 60068 part 2-6

Corrosion protection IEC 60068



NOTICE: Radio Interference

This is a class A device. This device may cause radio interference in residential areas. In this case, the user may be required to introduce appropriate countermeasures, and to bear the cost of same.

Approvals

CE

Electrical Data

Supply voltage 24 V DC (SELV / PELV in accordance with DIN EN 61131)

Residual ripple 5 % maximum

Minimum voltage 19.2 V

Maximum voltage 30 V

Power consumption (typical at 24 V) 100 mA

Connected load 2.4 W

Fuse Semiconductor fuse, self-resetting

Protection against polarity reversal Integrated

Front Panel and Enclosure

Enclosure	Plastic (Noryl)
Front panel material	Front frame: Plastic (Lexan) Front foil: Polyester
Front panel (H x W x D) in mm (Inch)	72.8 x 96.6 x 7 (2.866 x 3.803 x 0.275)
Seal	Circumferential rubber seal on the rear
Mounting cutout (H x W) in mm (Inch)	68 x 92 (2.677 x 3.622)
Mounting depth in mm (Inch)	About 55 (2.165)
Degree of protection	Front: IP54 Rear: IP20
Total weight	About 165 g

A 1 Index

C

Cable	
Ethernet.....	26
Connecting.....	14

D

Default	23
Diagnostics	
Ethernet.....	27
Dimensions	
Cutout.....	12
Front panel	11
Display	23

F

Fuse	29
------------	----

I

Identification.....	22
Intended use	8
Interface	
Ethernet.....	26

M

Maintenance	29
Mounting	10

N

Nameplate	22
Normal mode	16

P

Pin assignment	
Ethernet.....	26

S

Safety notes	7
Servicing	29
Standards	32
Supply Voltage.....	14
Switching on.....	16
Symbols	7

T

Target group	8
Technical data	31
Touch screen	23

U

Unpacking.....	9
----------------	---

