

DETAILS

Product Number	F14619_ANGELETTE-S-PLAIN
Family	Angelette
Type	Reflector
Color	metal
Diameter	110 mm
Height	57,3 mm
Style	round
Optic Material	PC
Holder Material	
Fastening	
Status	production ready
ROHS Compliant	Yes
Date Updated	8/02/2017



OPTICAL PROPERTIES

LED	Viewing Angle	Light Beam	Efficiency	cd/lm	Connector
V22 Gen6	19 deg	Asymmetric	90 %	3.500	IDEAL: 50-2204-CT + 50-2100AN
V13 Gen7	13 deg	Asymmetric	91 %	6.400	TE: 2213254-2 + OPTIC CLIP Z50 TYPE1 2213194-1
V22 Gen7	sim: 14	Asymmetric	sim: 94 %	sim: 5.760	IDEAL: 50-2204-CT + 50-2100AN
CLL03x/CLU03x	13 deg	Asymmetric	90 %	6.200	TE: 2213254-2 + OPTIC CLIP Z50 TYPE1 2213194-1
CLL04x/CLU04x	19 deg	Asymmetric	90 %	3.400	IDEAL: 50-2204-CT + 50-2100AN
CLU730/731	12 deg	Asymmetric	89 %	6.600	IDEAL: 50-2204-CT + 50-2100AN
CLL03x/CLU03x	13 deg	Asymmetric	89 %	6.000	IDEAL: 50-2103CT + 50-2100AN
LUXEON CoB 1208	13 deg	Asymmetric	89 %	5.600	IDEAL: 50-2100SH + 50-2100AN
LUXEON CoB 1208	13 deg	Asymmetric	89 %	6.200	TE: 2213130-2 + OPTIC CLIP Z50 TYPE1 2213194-1
LUXEON CoB 1211	17 deg	Asymmetric	89 %	4.200	IDEAL: 50-2204-CT + 50-2100AN
LUXEON CoB 1216	20 deg	Asymmetric	89 %	3.300	IDEAL: 50-2204-CT + 50-2100AN
COB L-Type (LES 11)	10 deg	Asymmetric	89 %	8.200	IDEAL: 50-2100NC + 50-2100AN
COB L-Type (LES 11)	10 deg	Asymmetric	90 %	9.500	TE: 2213382-2 + OPTIC CLIP Z50 TYPE1 2213194-1
PrevaLED Core Z4 LES19	14 deg	Asymmetric	90 %	5.400	TE: OPTIC CLIP Z50 TYPE1 2213194-1
Soleriq S19	14 deg	Asymmetric	90 %	5.300	TE: 2213407-2 + OPTIC CLIP Z50 TYPE1 2213194-1
Soleriq S13 Gen2	11 deg	Asymmetric	89 %	7.900	TE: 2213254-2 + OPTIC CLIP Z50 TYPE1 2213194-1
Fortimo SLM G5 LES 15 Standard	13 deg	Asymmetric	89 %	6.000	TE: OPTIC CLIP Z50 TYPE1 2213194-1
LC040C	10 deg	Asymmetric	90 %	8.800	TE: 2213382-2 + OPTIC CLIP Z50 TYPE1 2213194-1
AC Zhaga COB	13 deg	Asymmetric	90 %	6.400	Optosource: SEHSMJD-A
WU-M-484	12 deg	Asymmetric	89 %	7.100	TE: OPTIC CLIP Z50 TYPE1 2213194-1

NOTE:
 Customer may add additional light modifying parts to Angelette family(excluding the plain versions):
 Minimum height of additional part is 1.5mm and maximum is 2.2mm. Diameter is 105.9mm±0.3

57.26 + Basepart

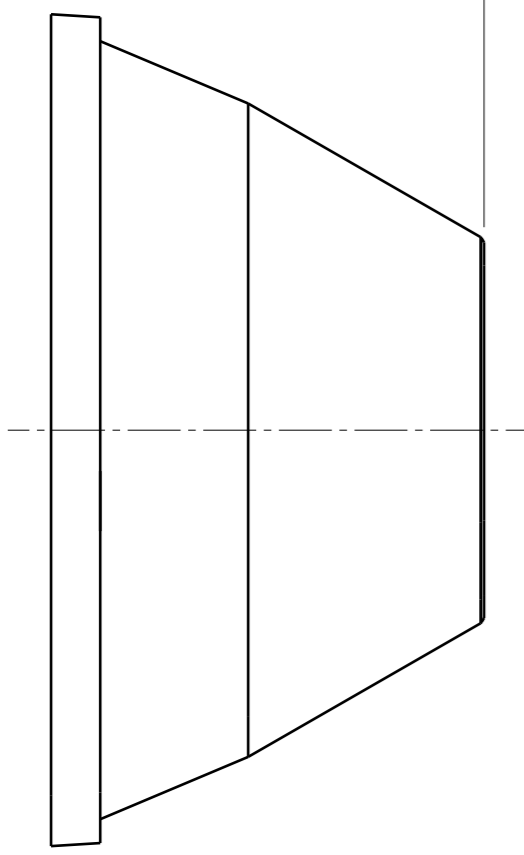

Front view

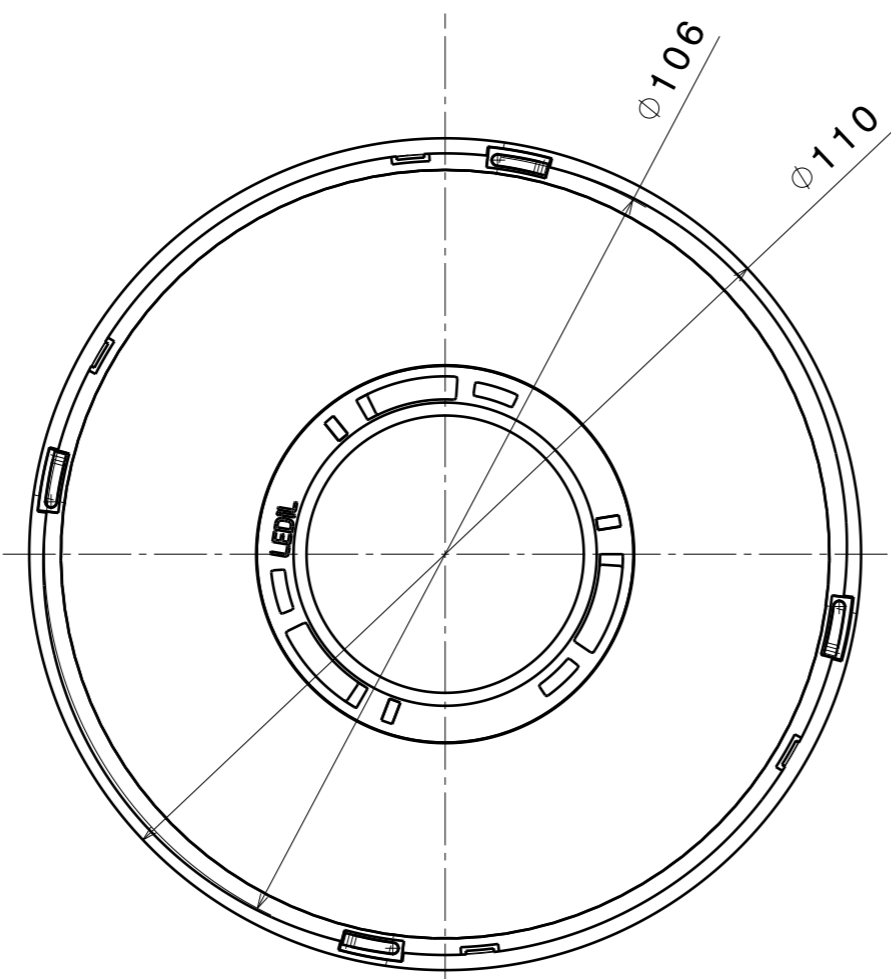

Top view



Additional part

2.5

Section view A-A

ANGELETTE-S

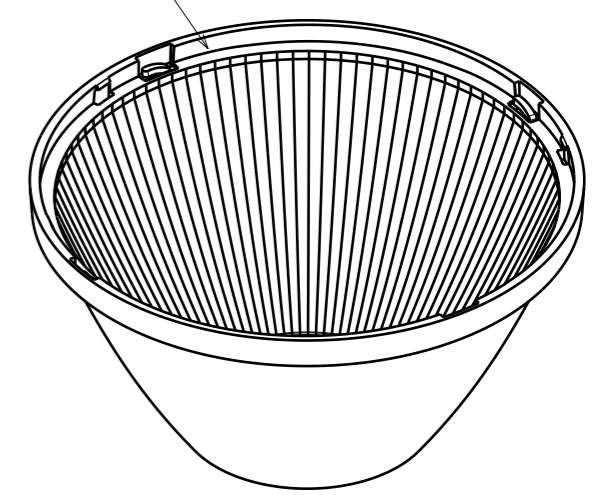

ANGELETTE-S-PLAIN

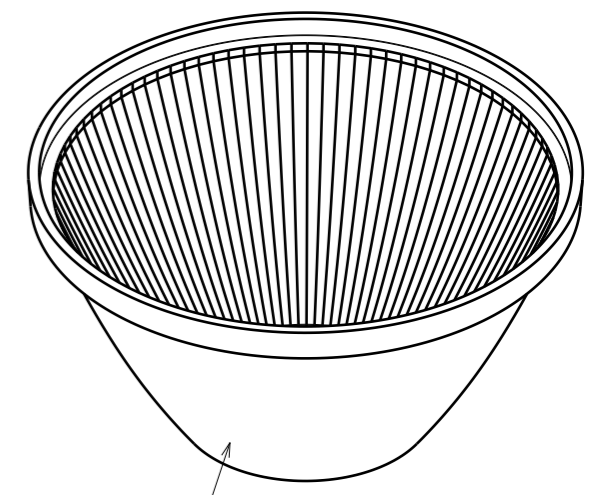

Tolerances if not otherwise shown
 According to DIN ISO 2768-1
 Linear measures:
 up to 30mm class M, otherwise class C
 According to DIN ISO 2768-2
 Form and position: class L

LEDiL Ledil Oy
 Salorankatu 10
 FIN 24240 SALO
 Finland

THIRD ANGLE PROJECTION:

DRAWING TITLE
Datasheet_ANGELETTE-S

This drawing is the property
 of LEDiL Oy. It may not be
 reproduced, copied or
 communicated without a written
 agreement with LEDiL Oy.

SIZE **A3** PART NUMBER **ANGELETTE-S**
ANGELETTE-S-PLAIN

SCALE **1:1** WEIGHT SHEET **1/1**

Luminaire: Ledil F14619_ANGELETTE-S-PLAIN_(V22+IDEAL)
Lamps: 1 x Bridgelux_V22_(BXRE30E6500H-Y2)_+50-2204CT_+_50-2100AN_1193.54lm@250mA_CCT=3000K_P=8.0988W_I=0.25A

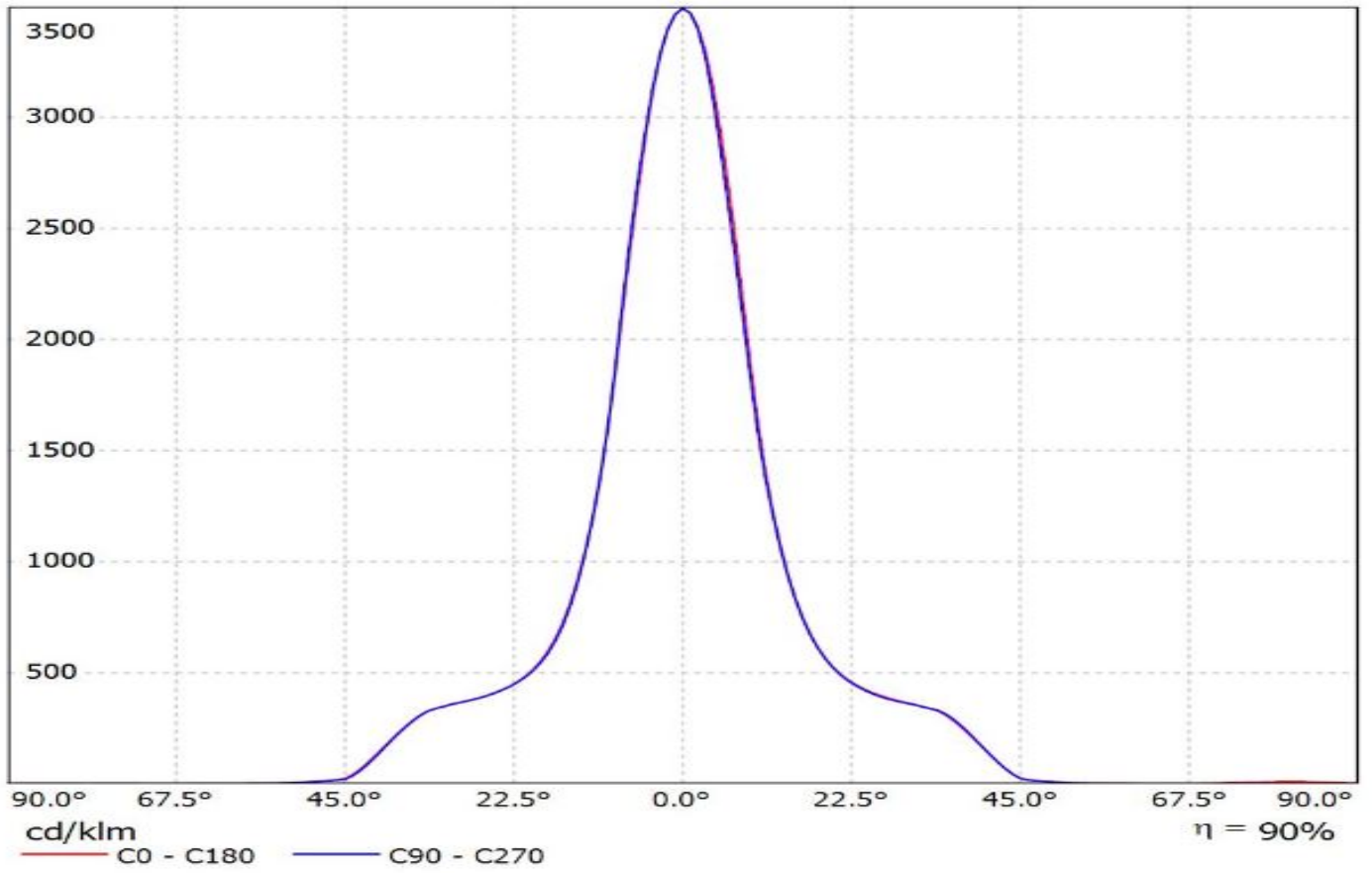

Luminaire: LEDiL Oy F14619_ANGELETTE-S-PLAIN_(V13_Gen7)+TE

Lamps: 1 x Bridgelux_V13_Gen7_(BXRE-30E2000-B_+TE_2213254-2+TE_2213194-1)_1295.55lm@250mA_P=8.30985W_I=0.25A

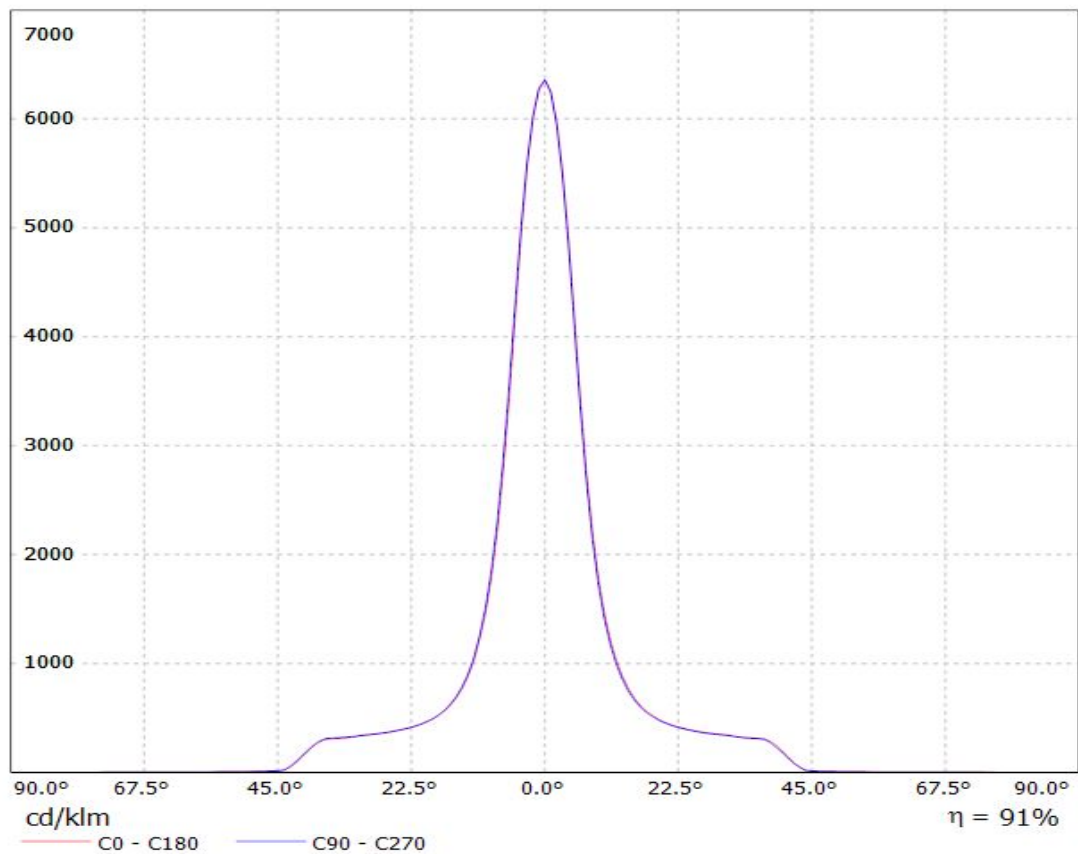

Luminaire: Ledil Oy F14619_ANGELETTE-S-PLAIN_Bridgelux_V22_Gen7_SIMULATED F14619_ANGELETTE-S-PLAIN_Bridgelux_V22_Gen7_SIMULATED
Lamps: 1 x F14619_ANGELETTE-S-PLAIN_Bridgelux_V22_Gen7_SIMULATED

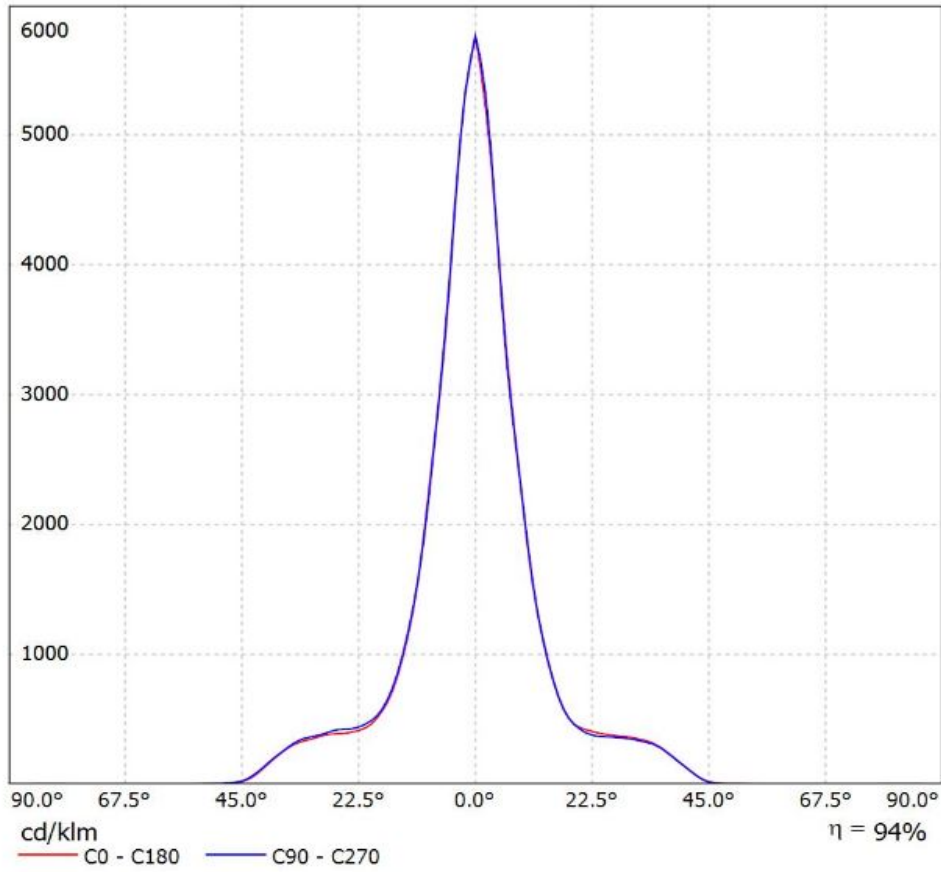

Luminaire: Ledil F14619_ANGELETTE-S-PLAIN_(CLU038+TE)
Lamps: 1 x Citizen_CLU038_(-1205C4-273MZK1)_+2213254-2_+2213194-1_1351.18lm@250mA_P=8.4078W_I=0.25A

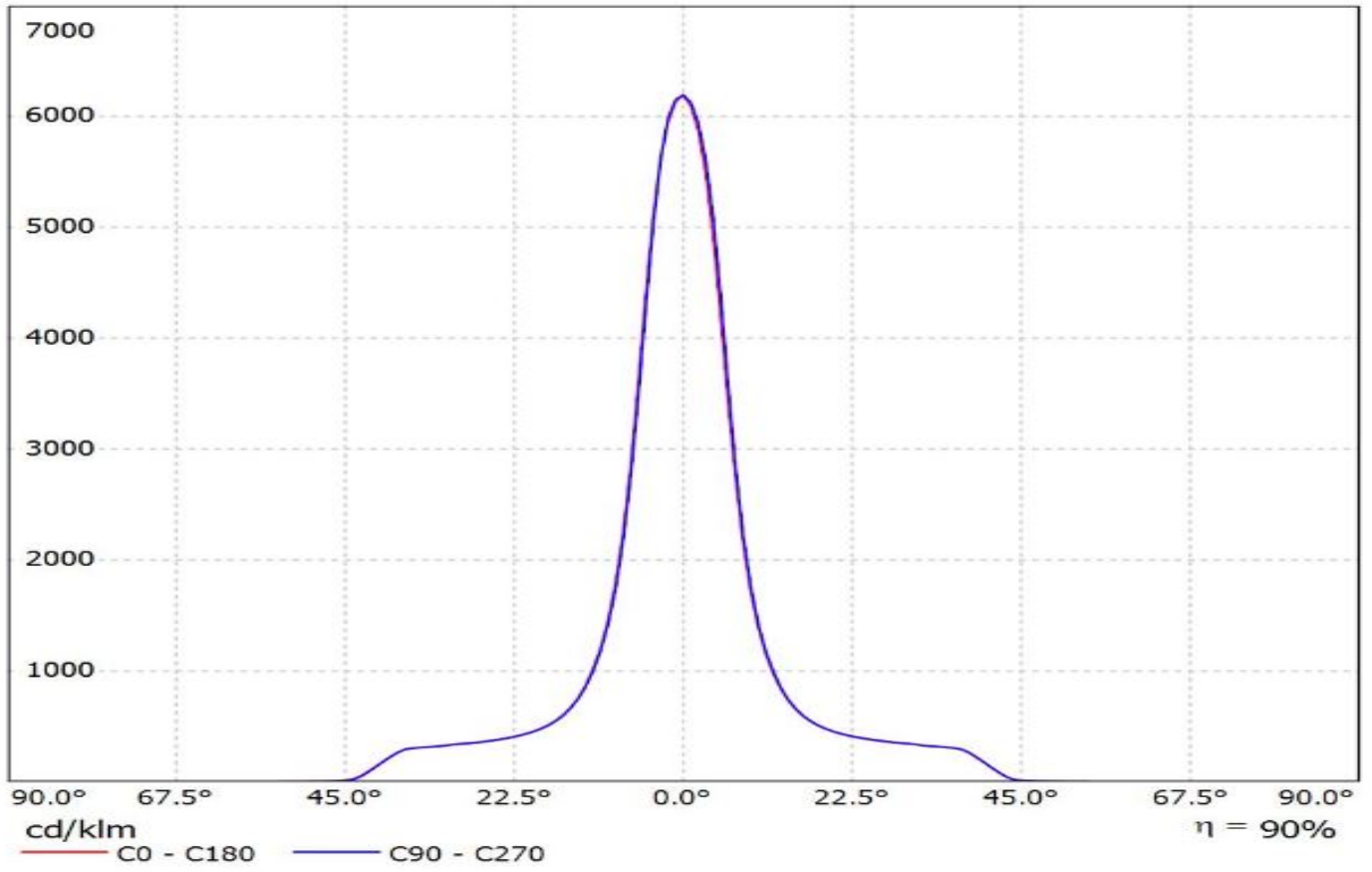

Luminaire: Ledil F14619_ANGELETTE-S-PLAIN_(CLU046+IDEAL)

Lamps: 1 x Citizen_CLU046_(-1212C1-303M2G2)_1383.92lm@250mA_CCT=3000K_P=8.122W_I=0.25A

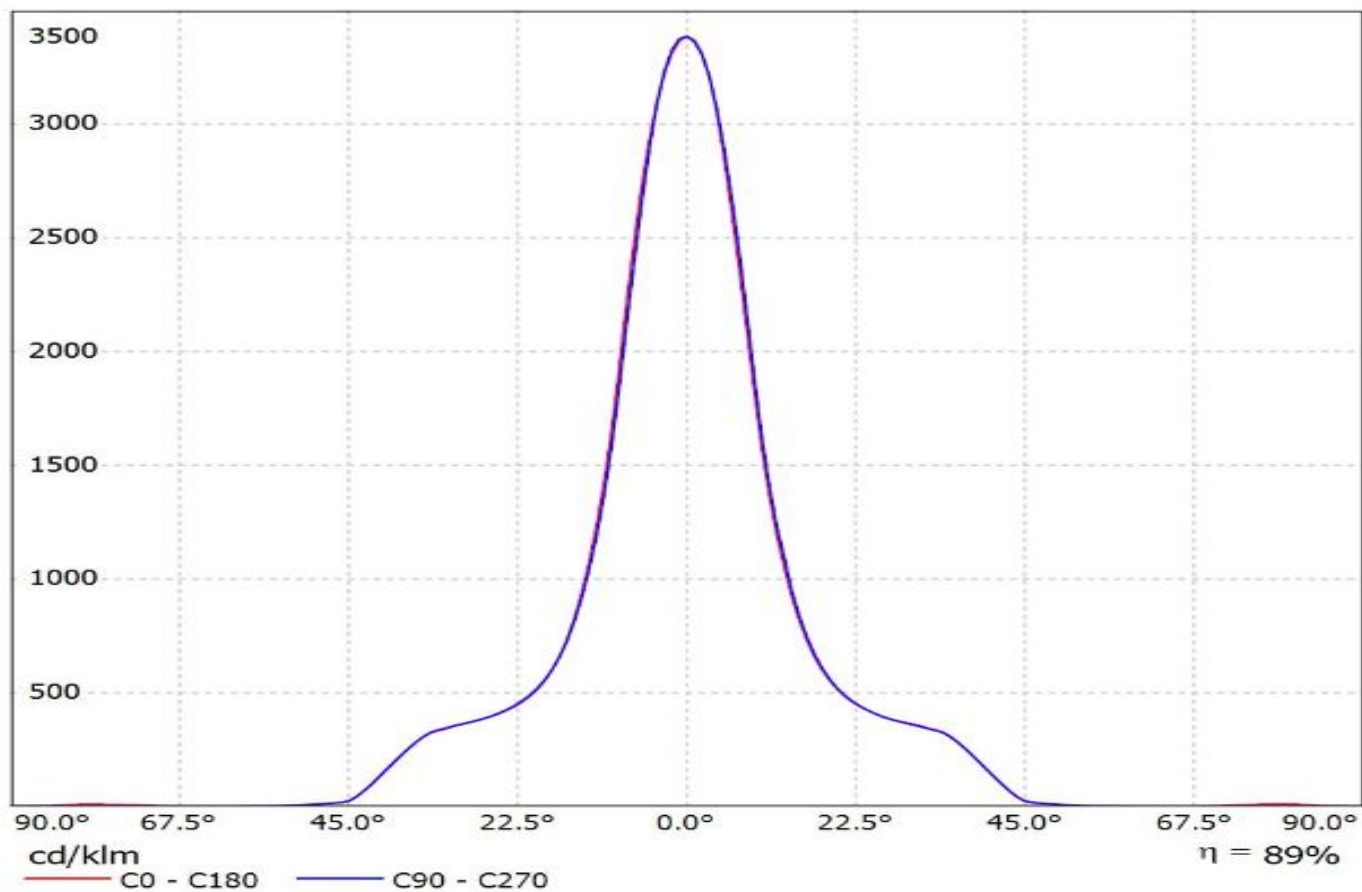

Luminaire: Ledil F14619_ANGELETTE-S-PLAIN_(CLU730+IDEAL)
Lamps: 1 x Citizen_CLU730_(-1210B8-273M2G1)_IDEAL_50-2204C+50-2100AN

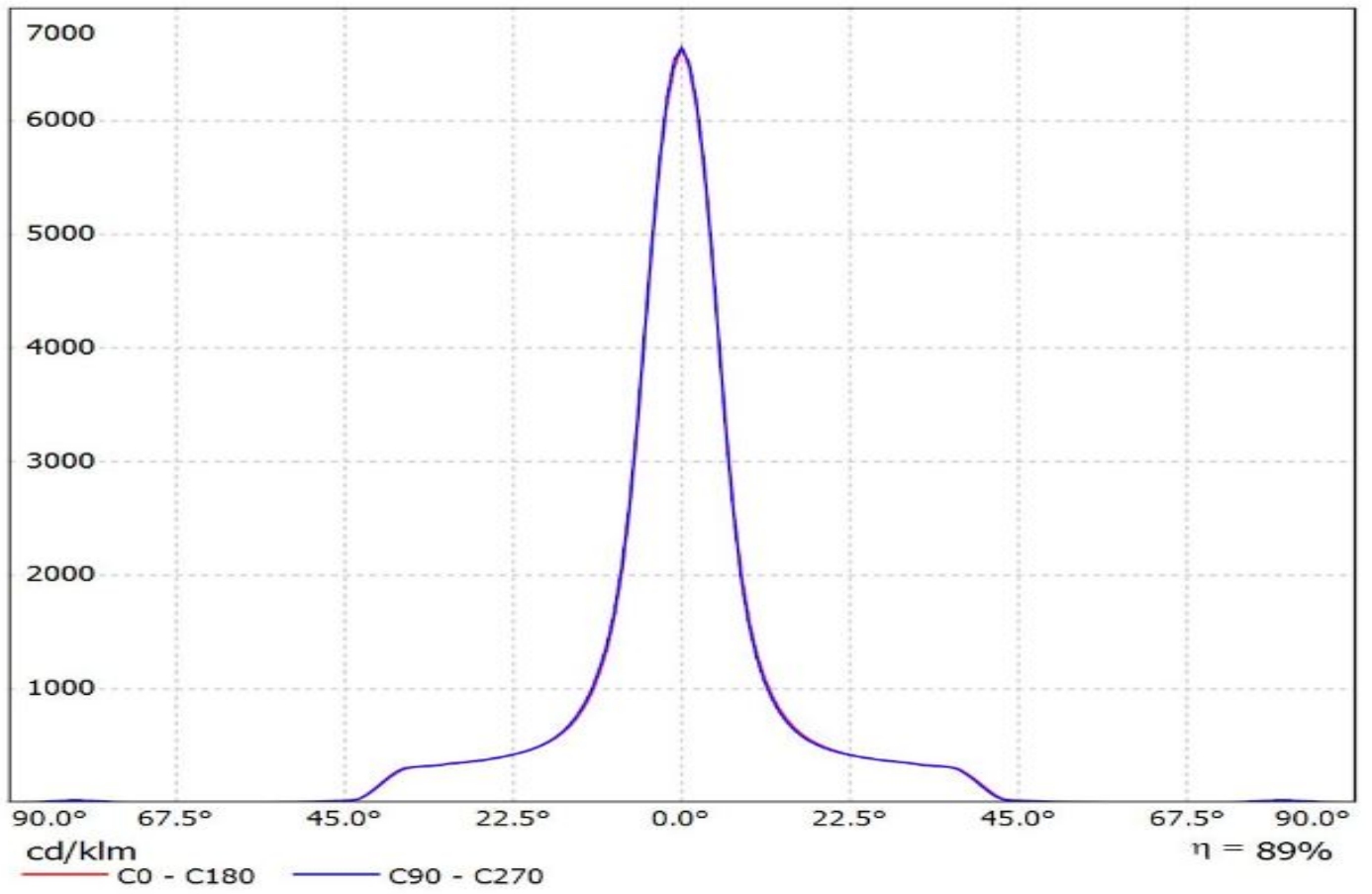

Luminaire: Ledil F14619_ANGELETTE-S-PLAIN_(CLU036+IDEAL)
Lamps: 1 x CITIZEN_CLU036_(-1208C1-303M2G2)_IDEAL_50-2103CT+50-2100AN_1299.86lm@250mA_CCT=3000K_P=8.249W_I=0.25A

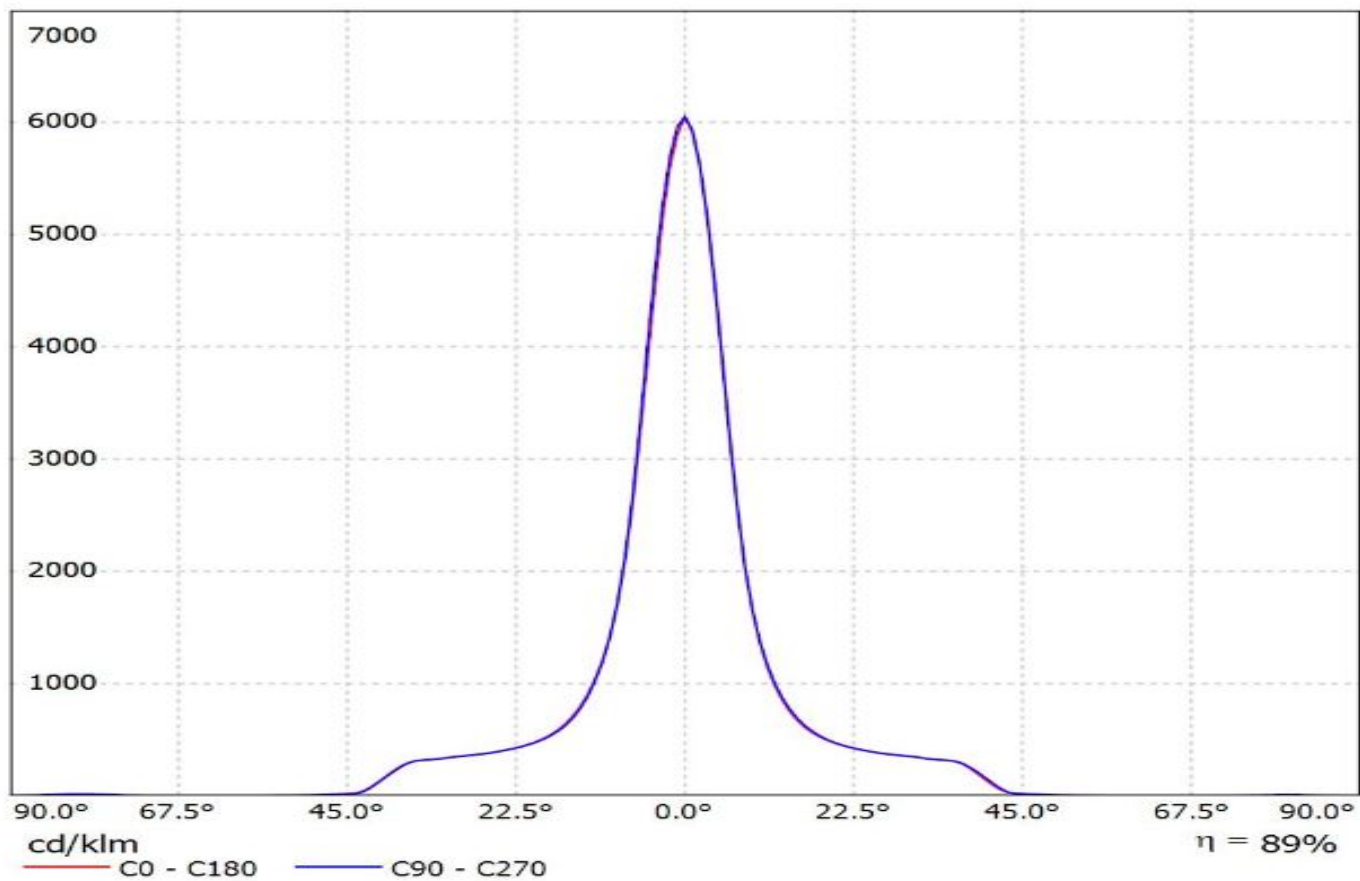

Luminaire: Ledil F14619_ ANGELETTE-S-PLAIN_(CoB1208+IDEAL)
Lamps: 1 x Luxeon_CoB1208_+_50-2100SH+50-
2100AN_1062.11lm@250mA_CCT=3000K_P=8.3007W_I=0.25A

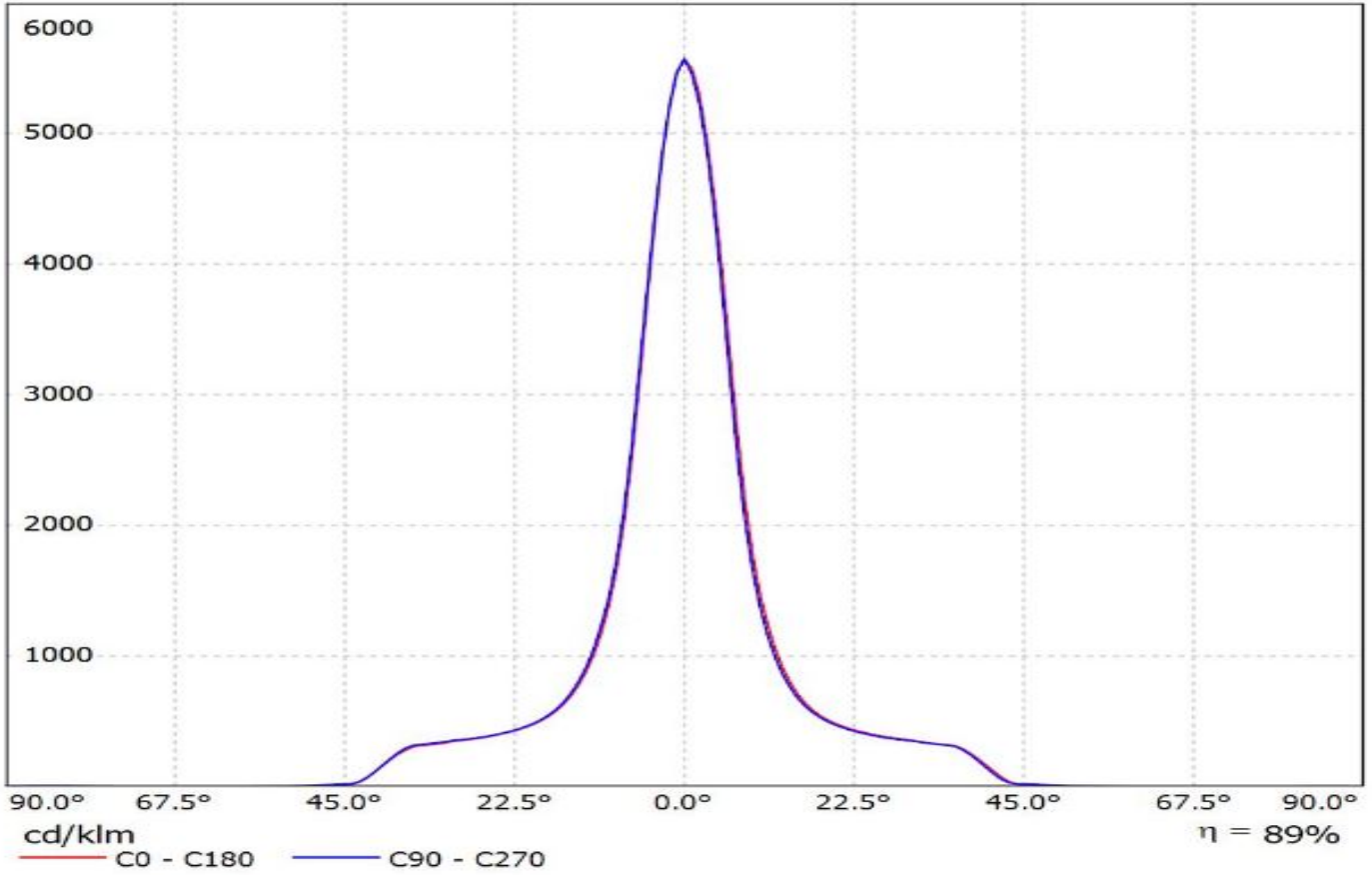

Luminaire: Ledil F14619_ANGELETTE-S-PLAIN_(CoB1208+TE)
Lamps: 1 x Luxeon_CoB1208_+ 2213130-2_+ 2213194-
1_1062.11lm@250mA_CCT=3000K_P=8.3007W_I=0.25A

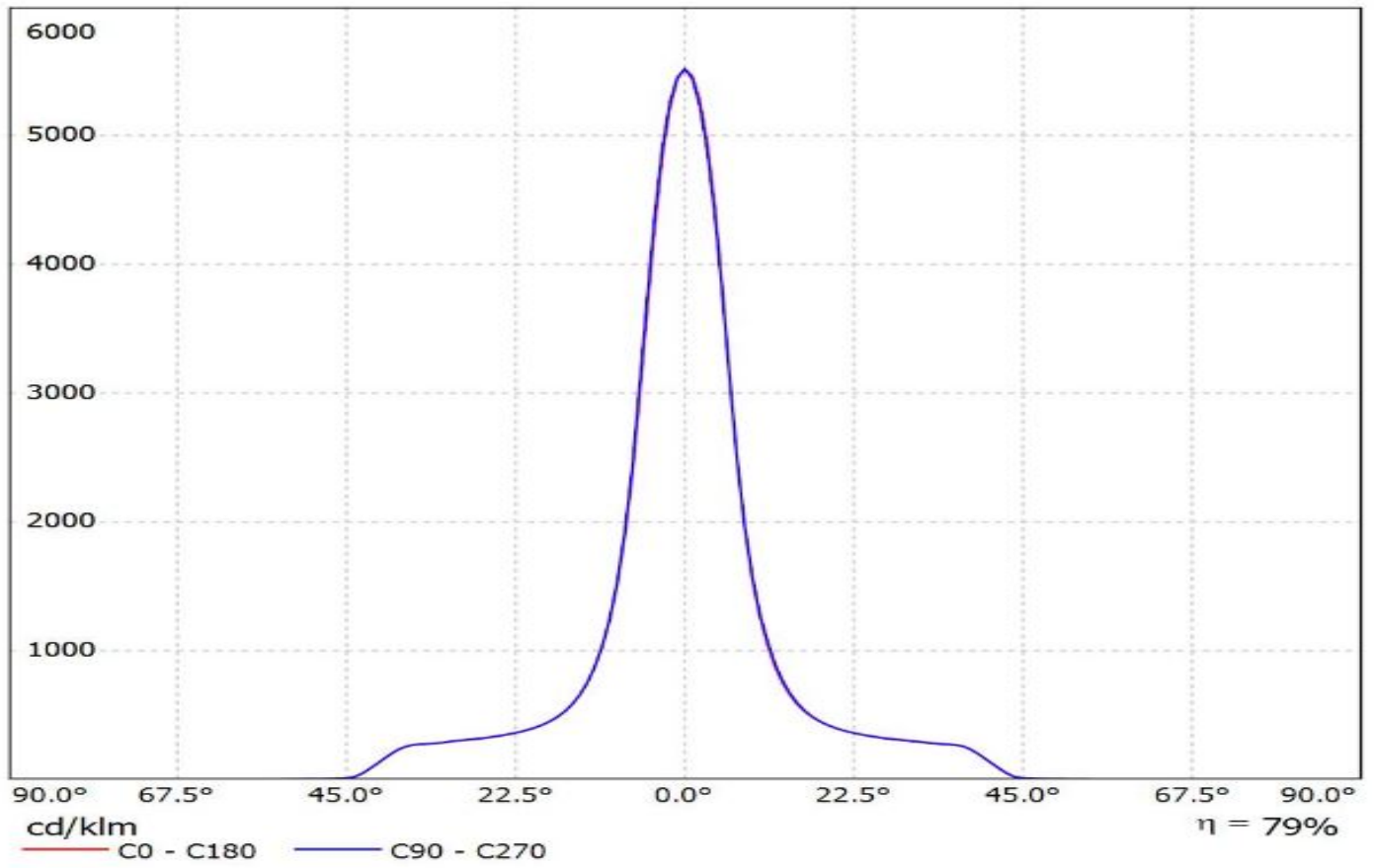

Luminaire: Ledil F14619_ANGELETTE-S-PLAIN_(CoB1211+IDEAL)
Lamps: 1 x Luxeon_CoB1211_(L2C2-4080)_50-2204CT+50-
2100AN_1376.18lm@250mA_P=7.9988W_I=0.25A

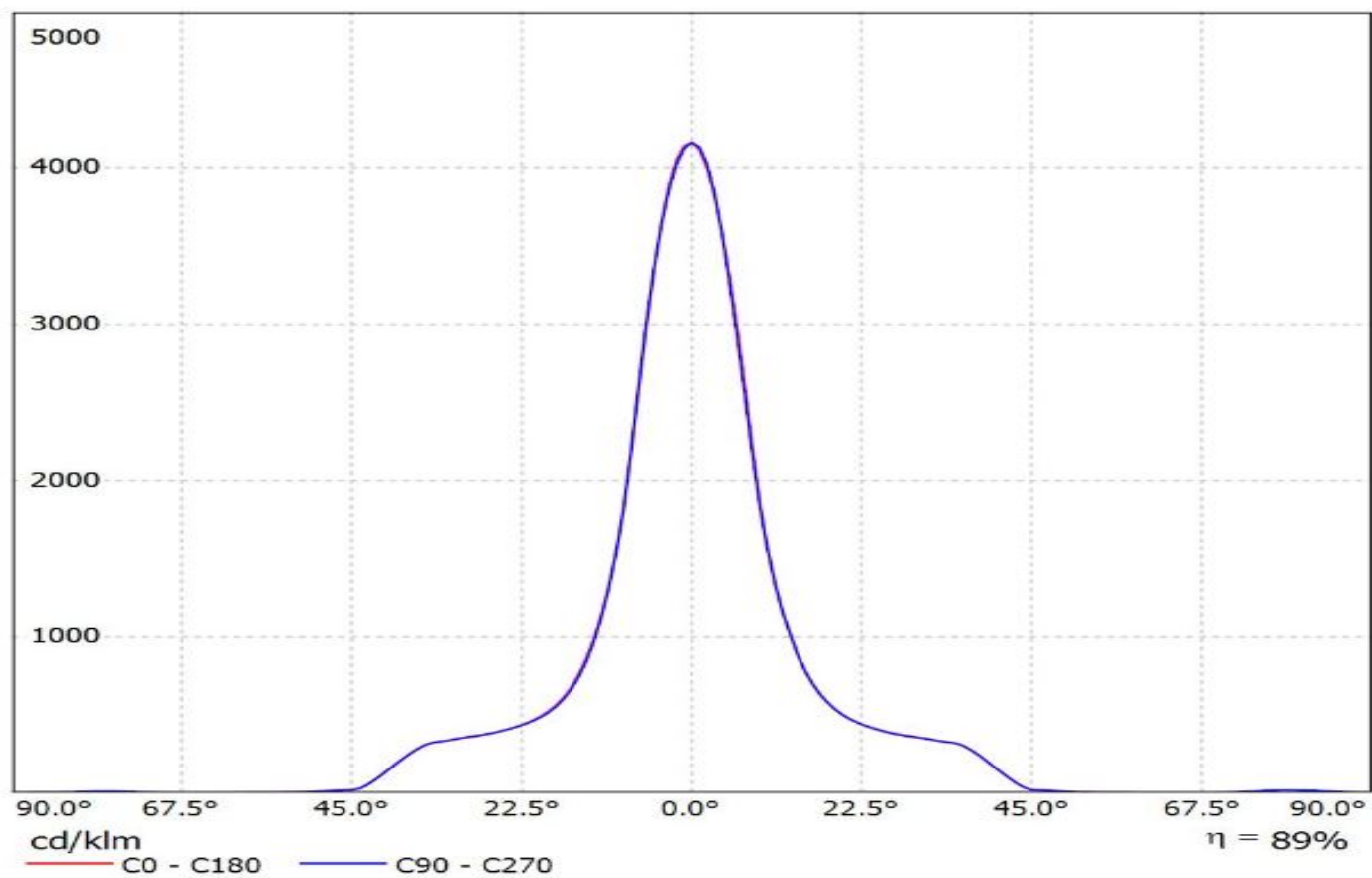

Luminaire: Ledil F14619_ ANGELETTE-S-PLAIN (CoB1216_IDEAL)
Lamps: 1 x Luxeon_CoB1216_(L2C2-40801216E2300)_+50-2204C_+_50-2100AN_1447.57lm@250mA_CCT=4000K_P=8.0135W_I=0.25A

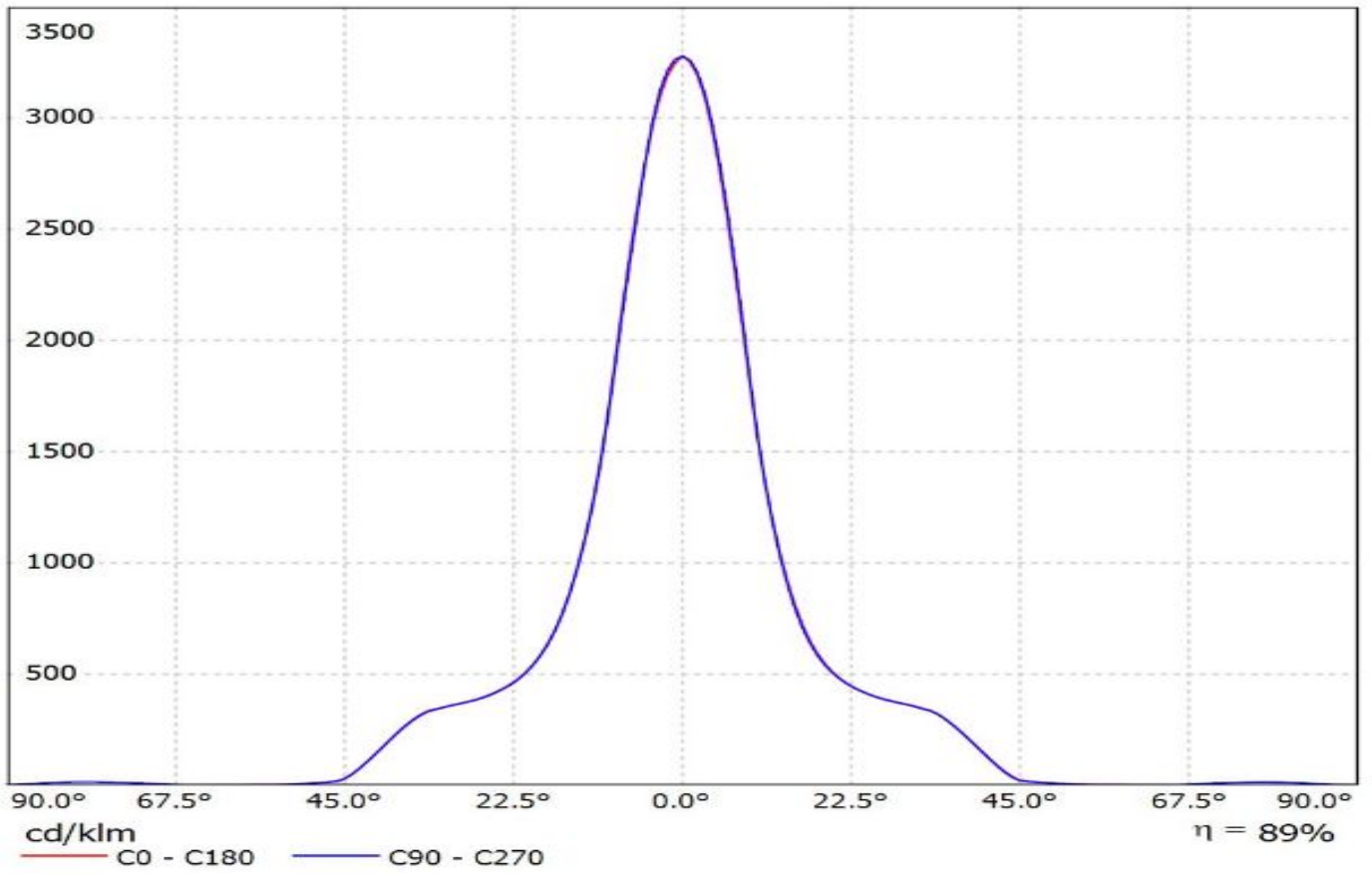

Luminaire: Ledil F14619_ANGELETTE-S-PLAIN_(NVCLL024Z+IDEAL)

Lamps: 1 x Nichia_NVCxL024z_(NVCLL024z)_975.455lm@250mA_P=8.1468W_I=250A

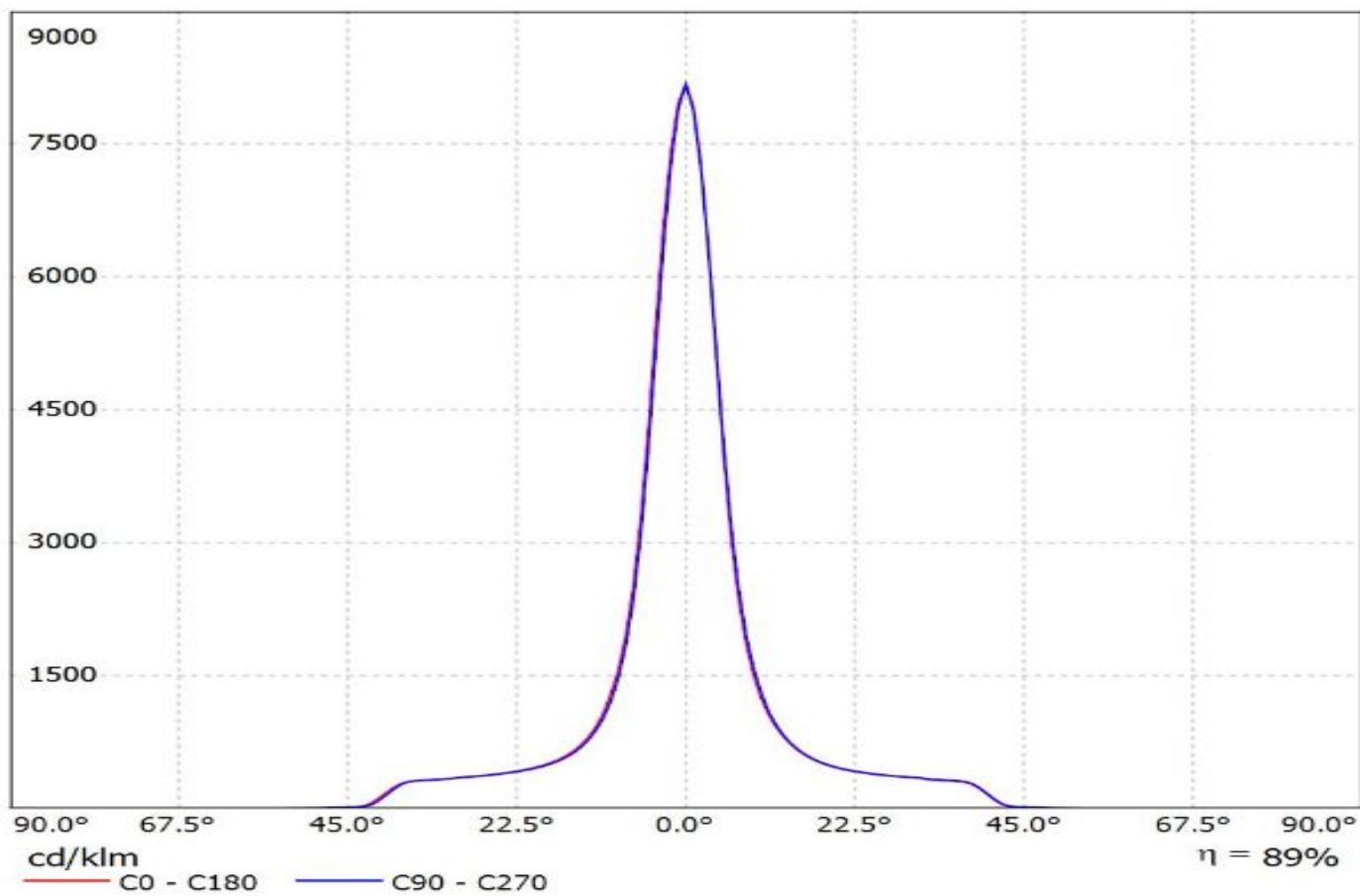

Luminaire: Ledil F14619_ANGELETTE-S-PLAIN_(NVCLL024Z+TE)
Lamps: 1 x Nichia_NVCLL024Z_+2213382-2_+2213194-
1_971.485lm@250mA_CCT=3000K_P=8W_I=0.25A

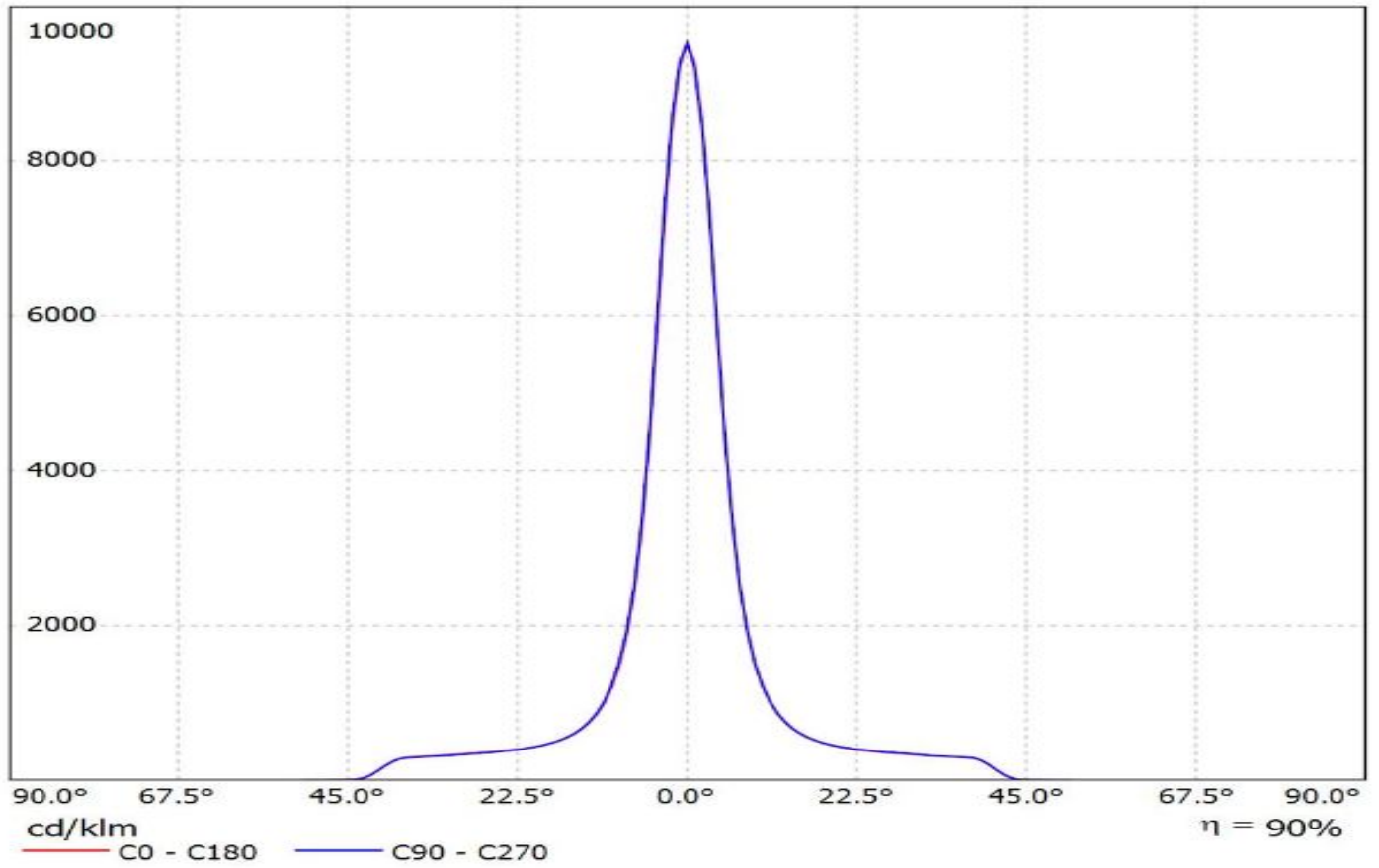

Luminaire: Ledil F14619_ANGELETTE-S-PLAIN_(PREVALED_Core_Z4)
Lamps: 1 x PREVALED_Core_Z4_LES19_1470.62lm@250mA_P=10.828W_I=0.25A

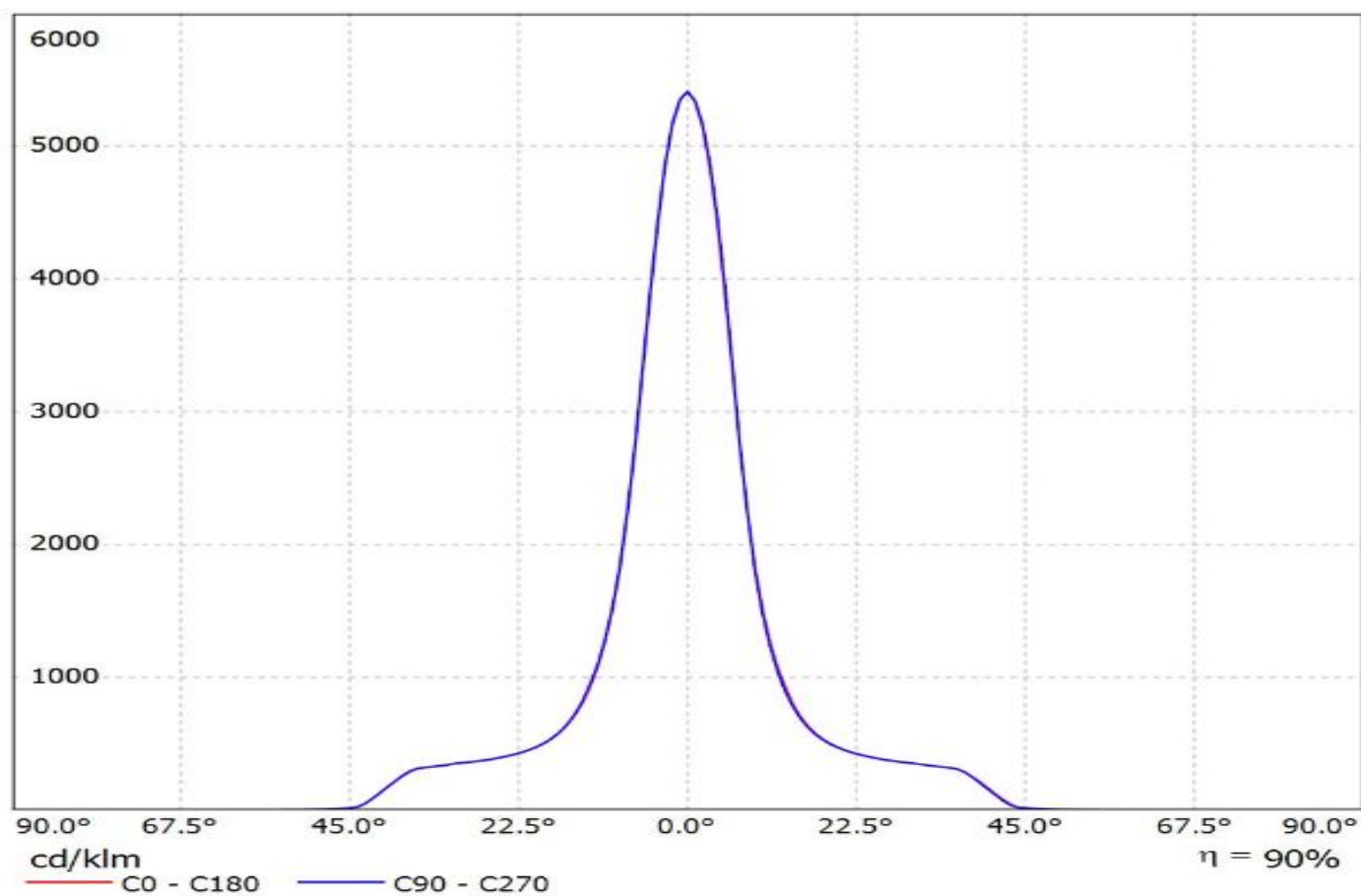

Luminaire: Ledil F14619_ANGELETTE-S-PLAIN_(S19+TE)

Lamps: 1 x Osram_Solericq_S19_(GW_KAHJB1.EM)_+2213407-2+2213194-1_1546.1lm@250mA_CCT=3000K_P=11.021W_I=0.25A

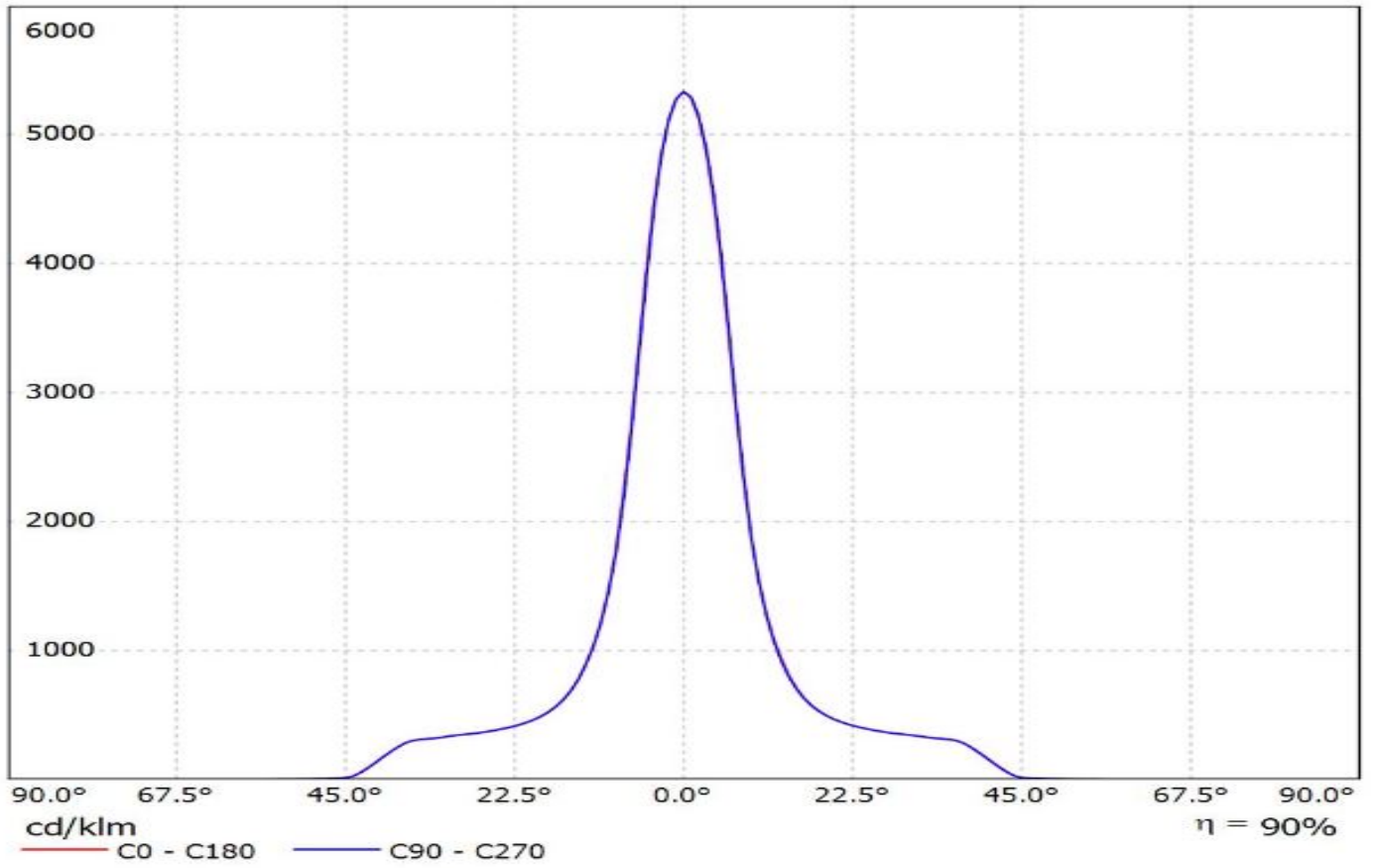

Luminaire: Ledil F14619_ANGELETTE-S-PLAIN_(S13_Gen2+TE)

Lamps: 1 x Soleriq_S13_Gen2+_2213254-2+_2213194-1_1309.23lm@250mA_P=8.7840W_I=0.250A

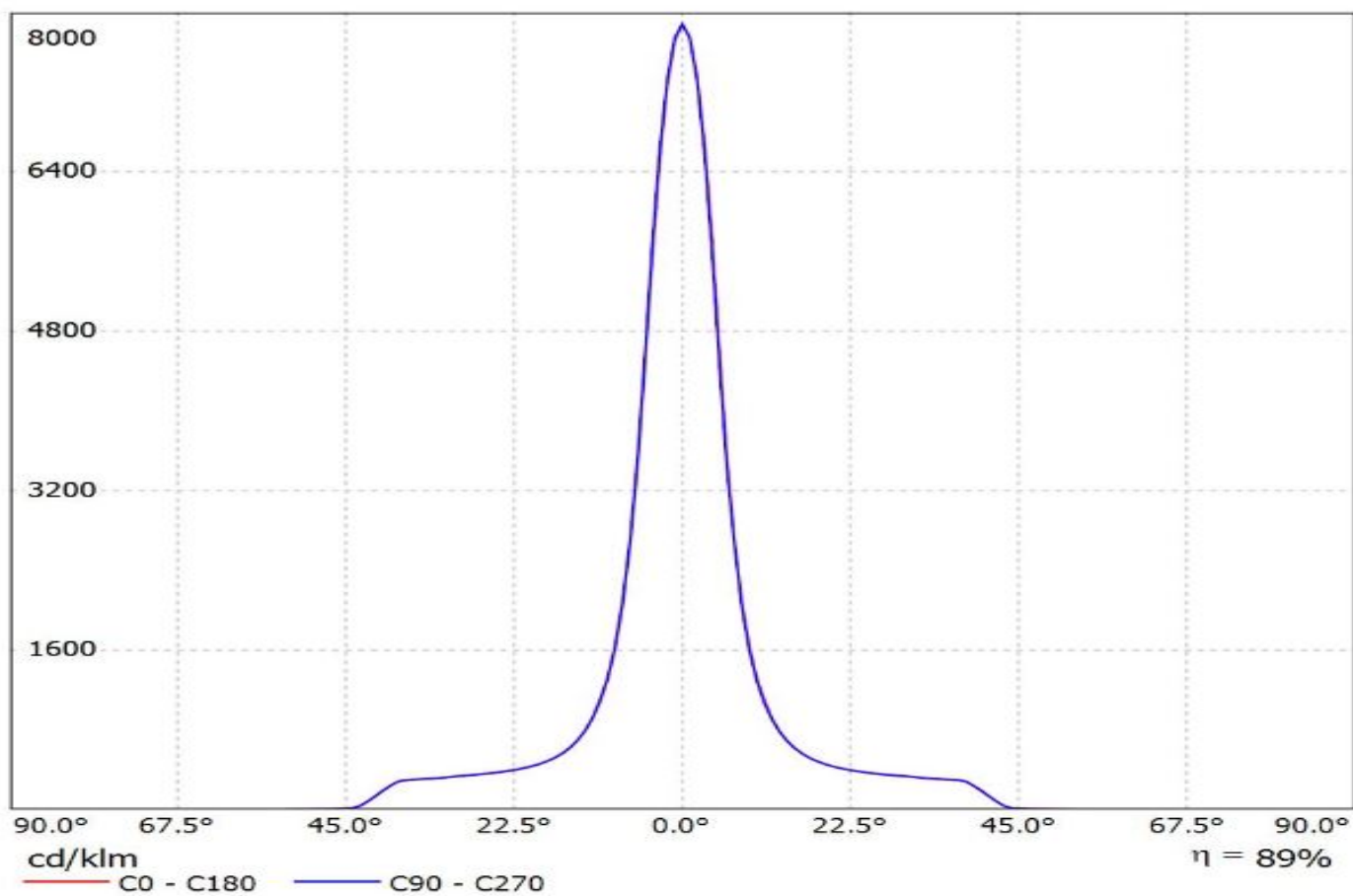

Luminaire: Ledil F14619_ANGELETTE-S-PLAIN_(SLM_G5_LES_15_+TE)

Lamps: 1 x Philips_SLM_G5_LES_15_+TE_2213194-1_1277.72lm@250mA_P=8.208W_I=0.25A

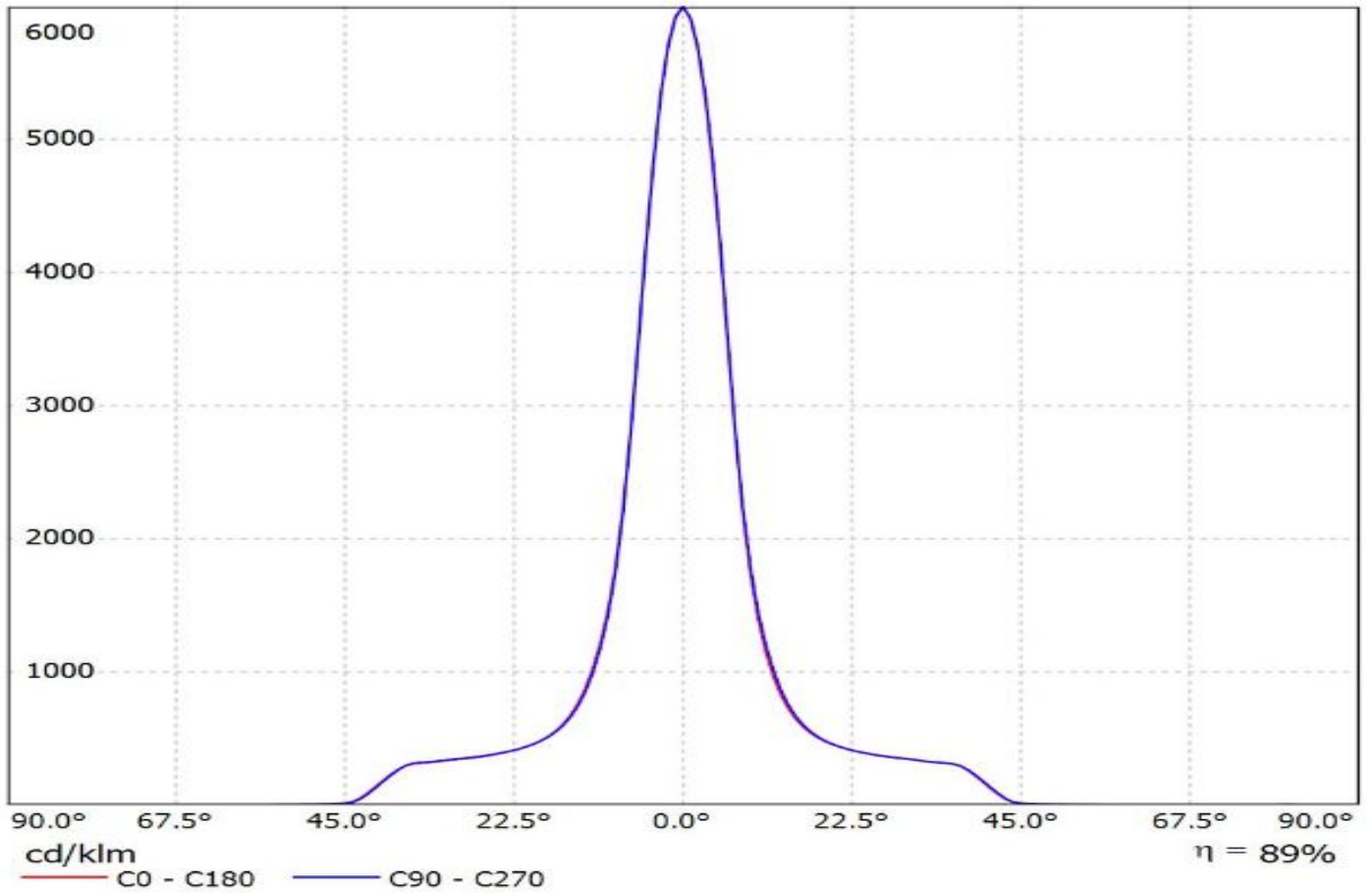

Luminaire: Ledil F14619_ANGELETTE-S-PLAIN_(LC040C+TE)

Lamps: 1 x Samsung_LC040C+_2213382-2+_2213194-1_1194.16lm@250mA_CCT=4000K_P=8.137W

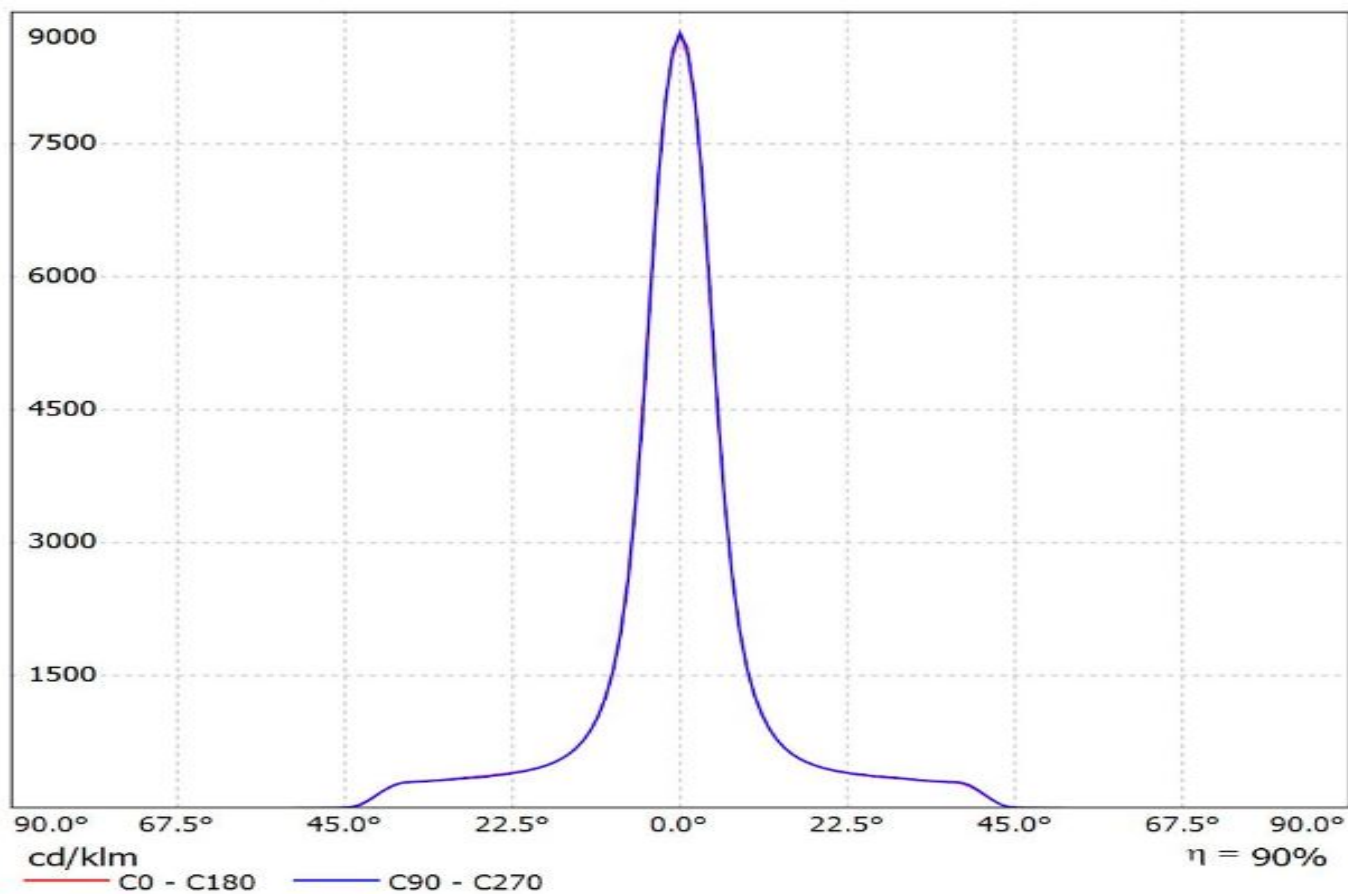

Luminaire: Ledil F14619_ANGELETTE-S-PLAIN_(SEOUL_AC_Zhaga_COB)
Lamps: 1 x SEOUL_AC_Zhaga_COB

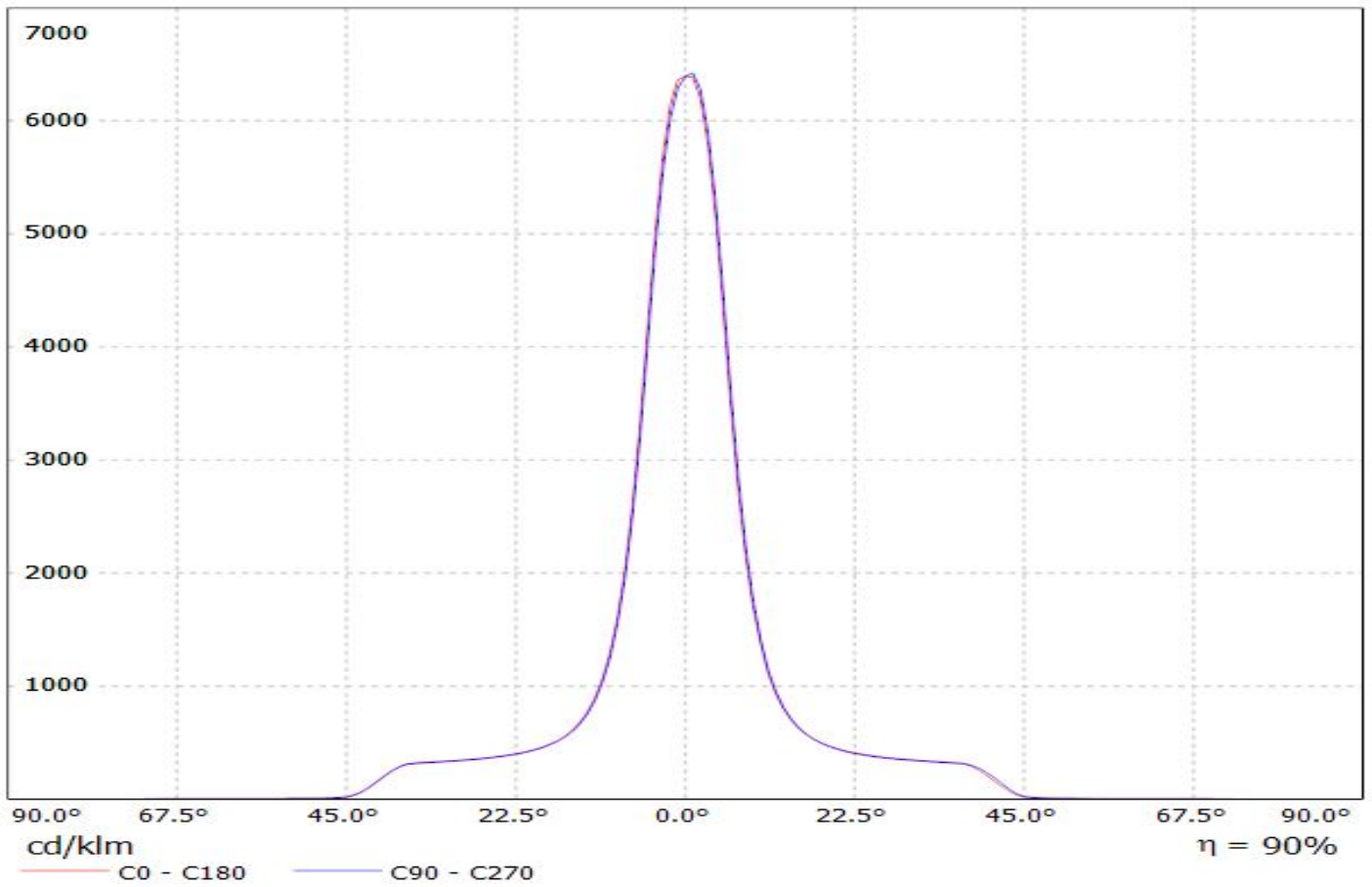

Luminaire: Ledil F14619_ANGELETTE-S-PLAIN_(WU-M-484+TE)

Lamps: 1 x Vossloh_Schwabe_WU-M-484-830_681.21lm@250mA_P=5.6195W_I=0.25A

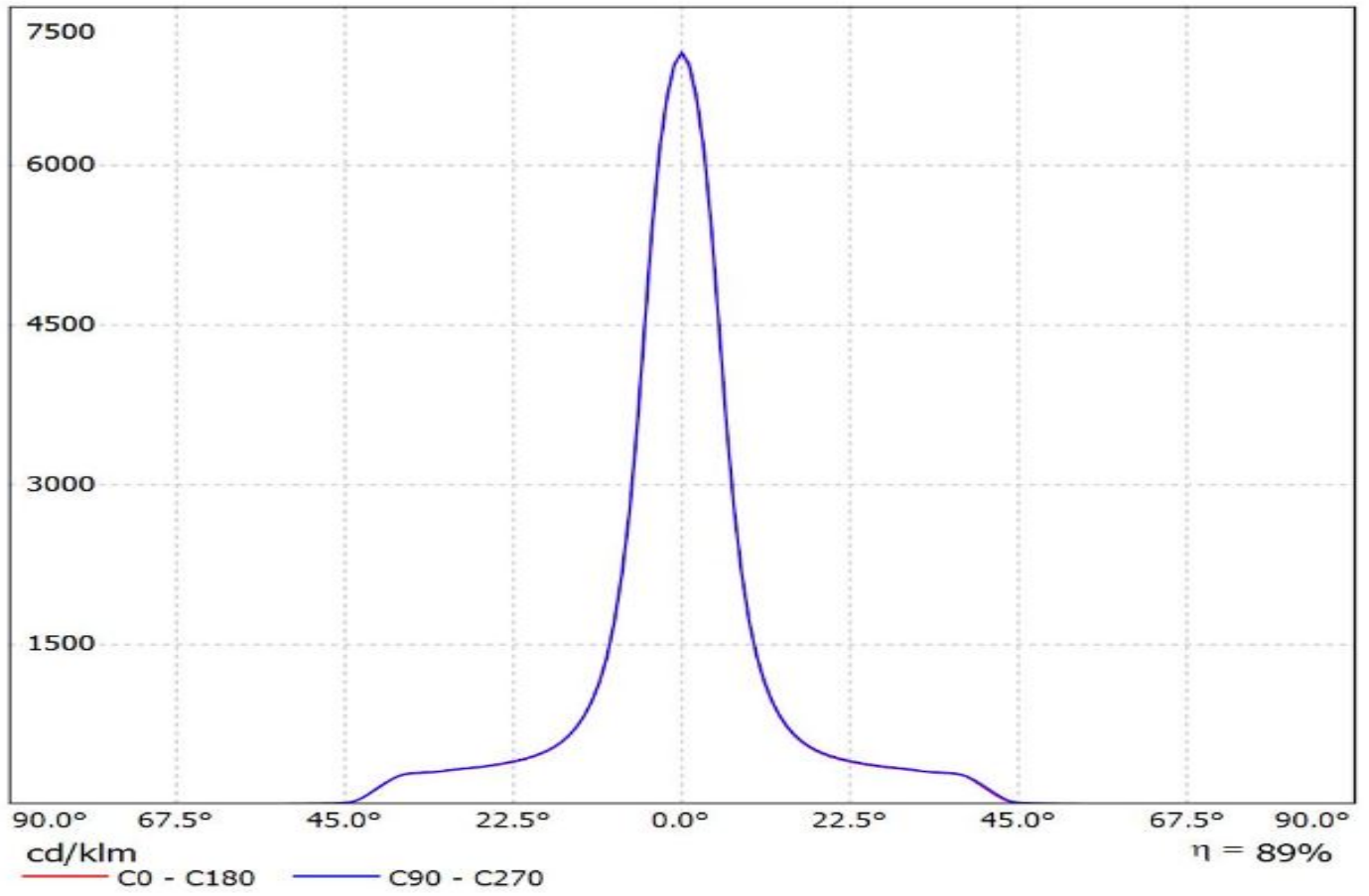

Luminaire: Ledil F14619_ANGELETTE-S-PLAIN_(V22+IDEAL)
Lamps: 1 x Bridgelux_V22_(BXRE30E6500H-Y2)_+50-2204CT_+_50-2100AN_1193.54lm@250mA_CCT=3000K_P=8.0988W_I=0.25A

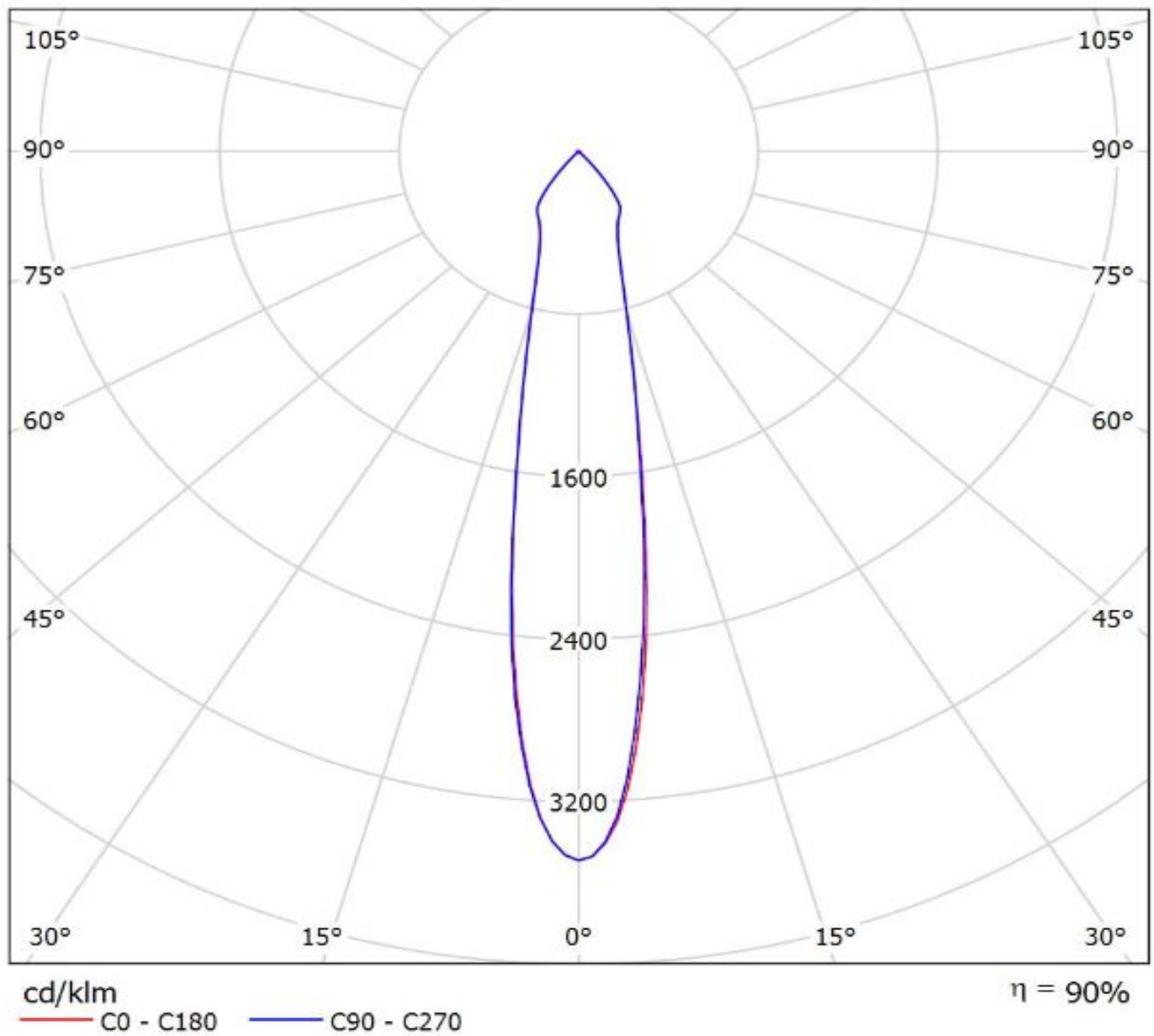

Luminaire: LEDiL Oy F14619_ ANGELETTE-S-PLAIN_(V13_Gen7)+TE

Lamps: 1 x Bridgelux_V13_Gen7_(BXRE-30E2000-B_+TE_2213254-2+TE_2213194-1)_1295.55lm@250mA_P=8.30985W_I=0.25A

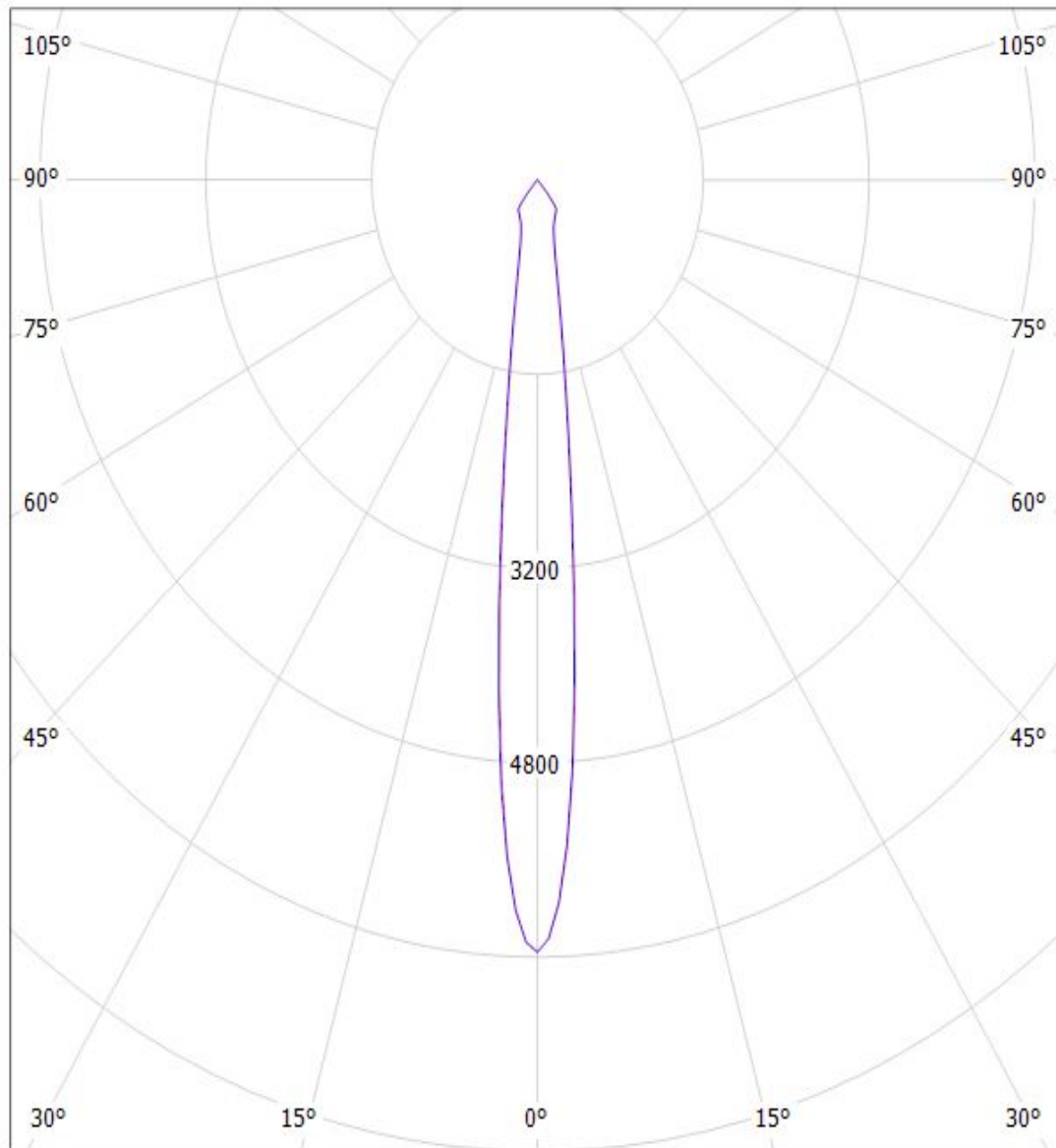

cd/klm

— C0 - C180 — C90 - C270

$\eta = 91\%$

Luminaire: Ledil Oy F14619_ANGELETTE-S-PLAIN_Bridgelux_V22_Gen7_SIMULATED F14619_ANGELETTE-S-PLAIN_Bridgelux_V22_Gen7_SIMULATED
Lamps: 1 x F14619_ANGELETTE-S-PLAIN_Bridgelux_V22_Gen7_SIMULATED

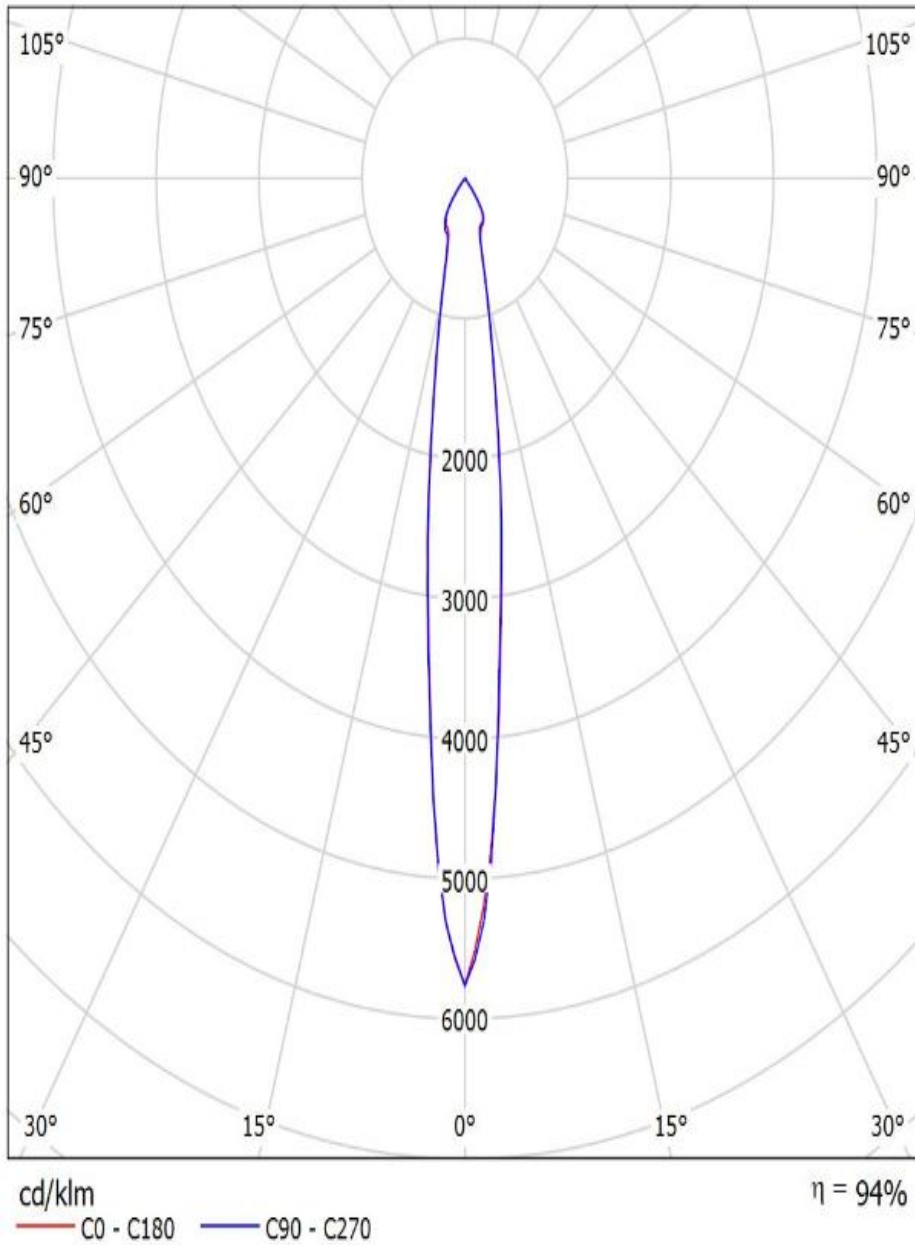

Luminaire: Ledil F14619_ANGELETTE-S-PLAIN_(CLU038+TE)
Lamps: 1 x Citizen_CLU038_(-1205C4-273MZK1)_+2213254-2_+2213194-1_1351.18lm@250mA_P=8.4078W_I=0.25A

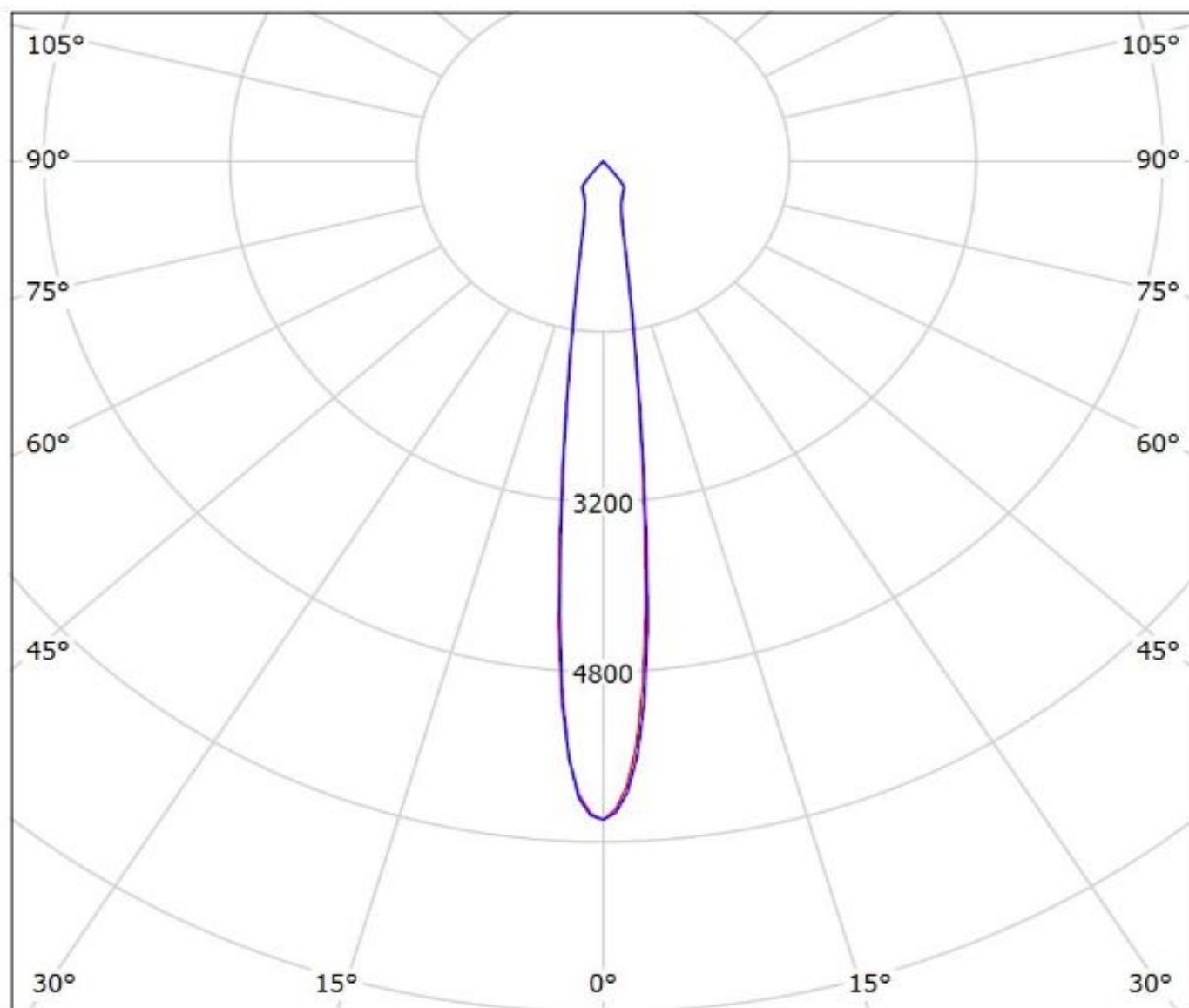

cd/klm

— C0 - C180 — C90 - C270

$\eta = 90\%$

Luminaire: Ledil F14619_ANGELETTE-S-PLAIN_(CLU046+IDEAL)

Lamps: 1 x Citizen_CLU046_(-1212C1-303M2G2)_1383.92lm@250mA_CCT=3000K_P=8.122W_I=0.25A

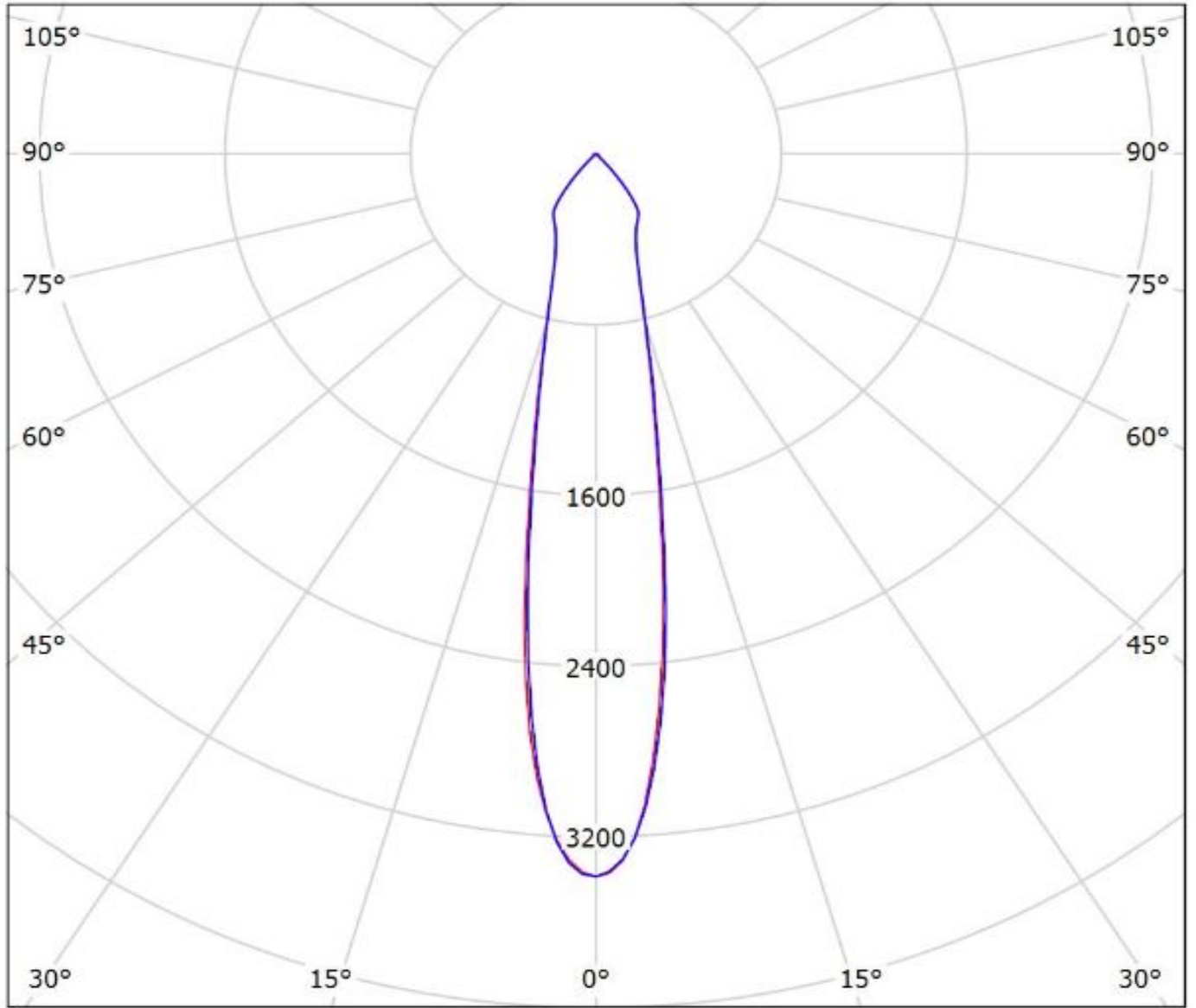

cd/klm

— C0 - C180

— C90 - C270

$\eta = 89\%$

Luminaire: Ledil F14619_ ANGELETTE-S-PLAIN_(CLU730+IDEAL)

Lamps: 1 x Citizen_CLU730_(-1210B8-273M2G1)_IDEAL_50-2204C+50-2100AN

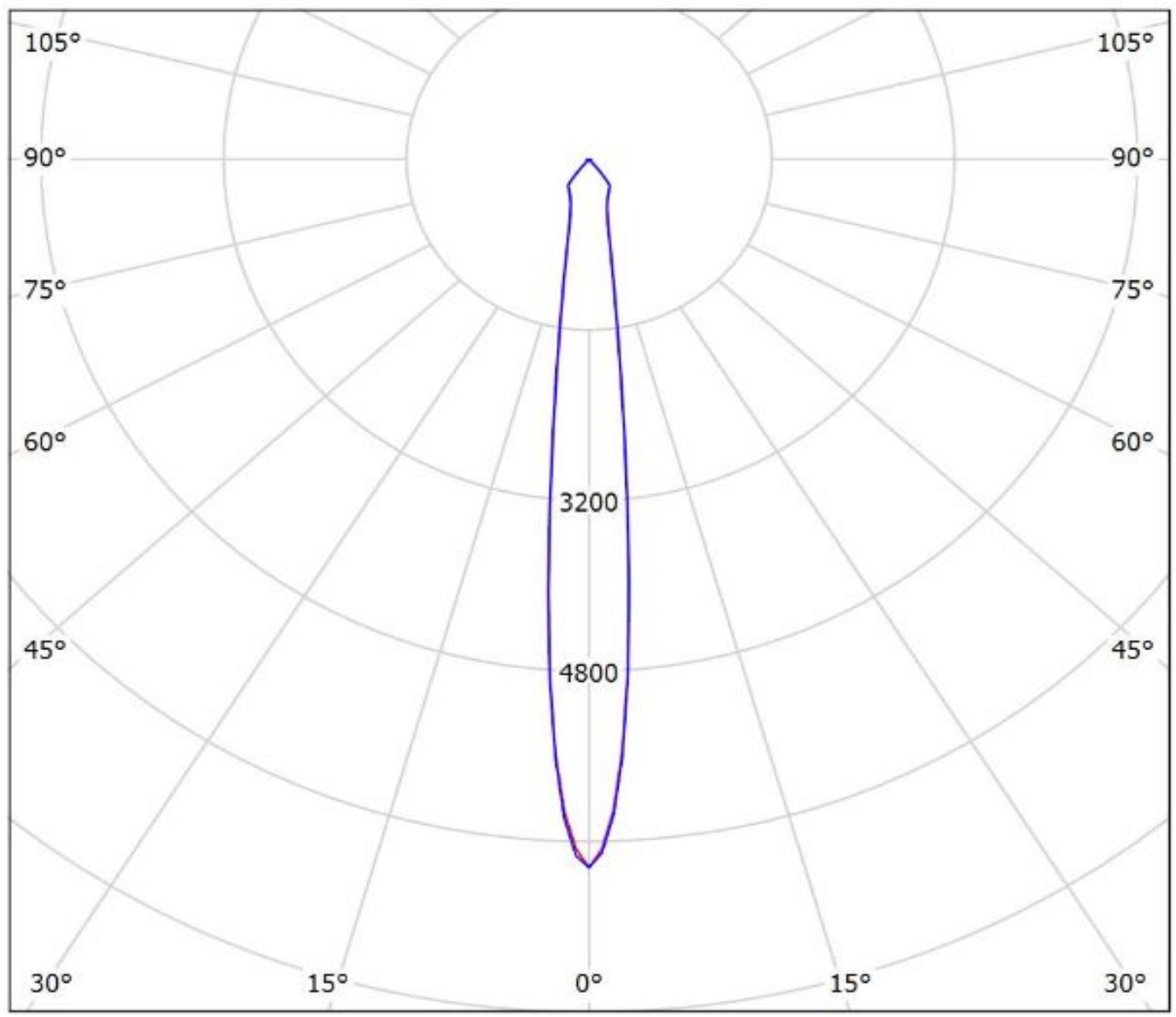

cd/klm

— C0 - C180

— C90 - C270

$\eta = 89\%$

Luminaire: Ledil F14619_ANGELETTE-S-PLAIN_(CLU036+IDEAL)
Lamps: 1 x CITIZEN_CLU036_(-1208C1-303M2G2)_IDEAL_50-2103CT+50-2100AN_1299.86lm@250mA_CCT=3000K_P=8.249W_I=0.25A

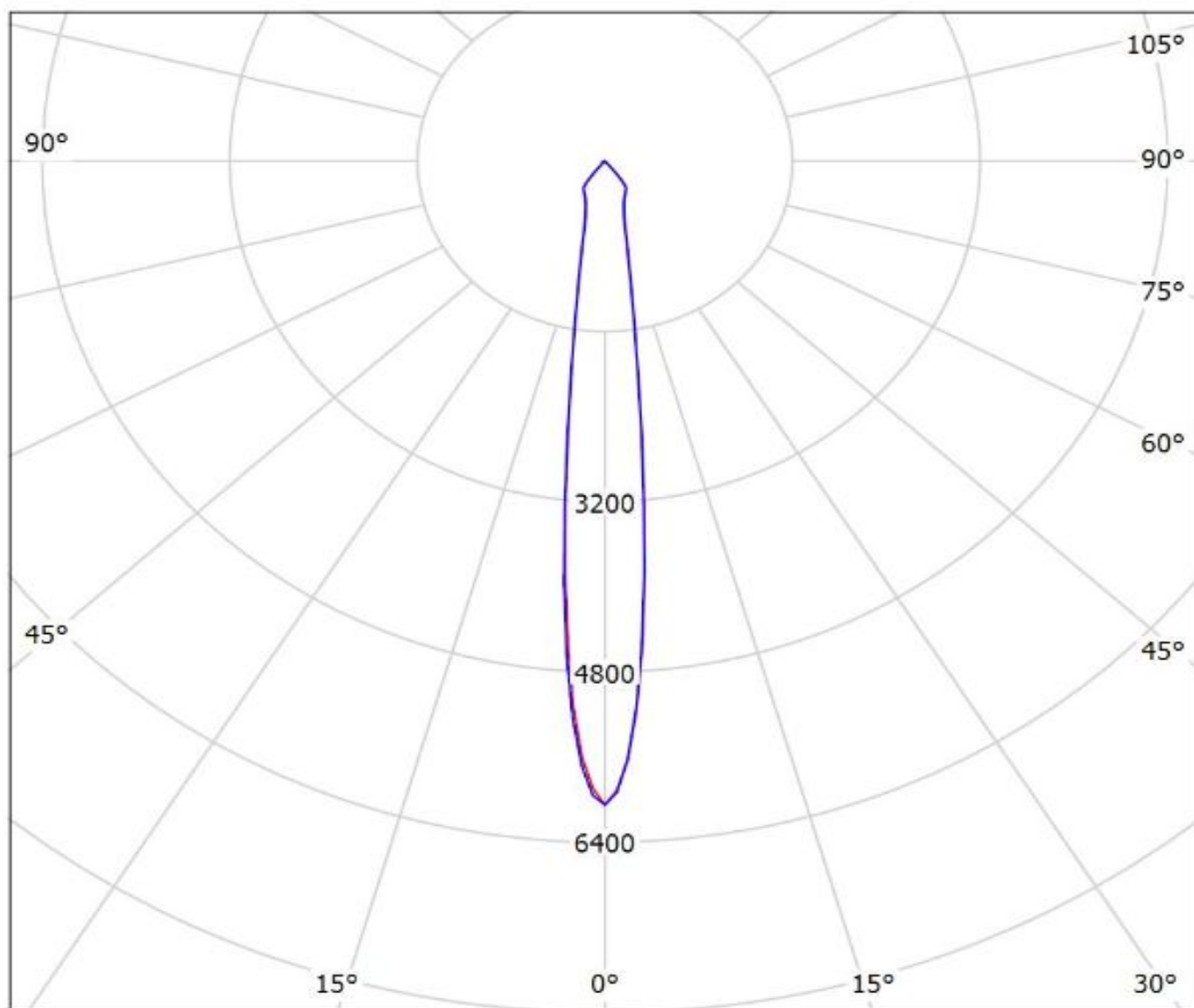

cd/klm
— C0 - C180 — C90 - C270

$\eta = 89\%$

Luminaire: Ledil F14619_ANGELETTE-S-PLAIN_(CoB1208+IDEAL)

Lamps: 1 x Luxeon_CoB1208_+_50-2100SH+50-

2100AN_1062.11lm@250mA_CCT=3000K_P=8.3007W_I=0.25A

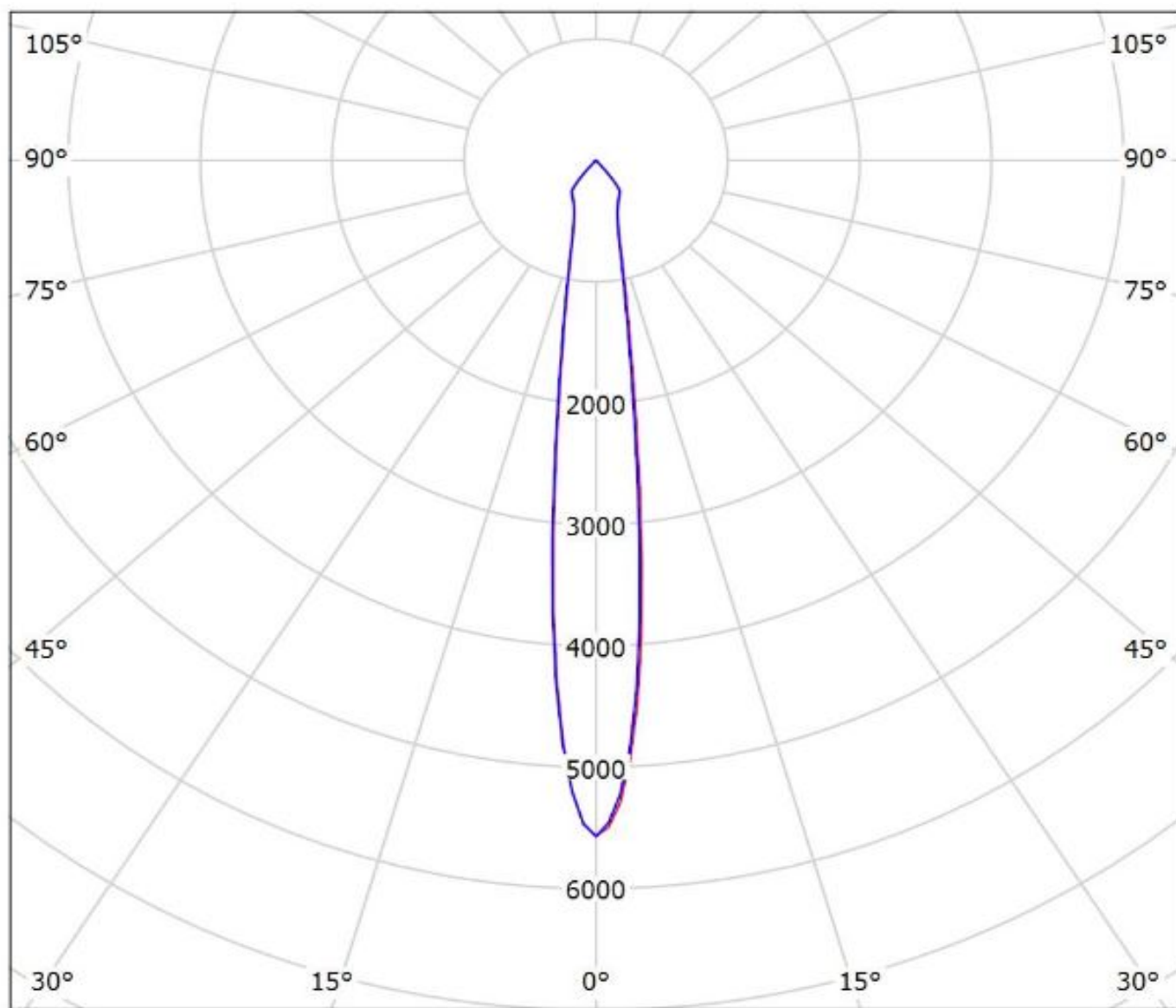

cd/klm

— C0 - C180

— C90 - C270

$\eta = 89\%$

Luminaire: Ledil F14619_ANGELETTE-S-PLAIN_(CoB1208+TE)

Lamps: 1 x Luxeon_CoB1208_+ 2213130-2_+ 2213194-1_1062.11lm@250mA_CCT=3000K_P=8.3007W_I=0.25A

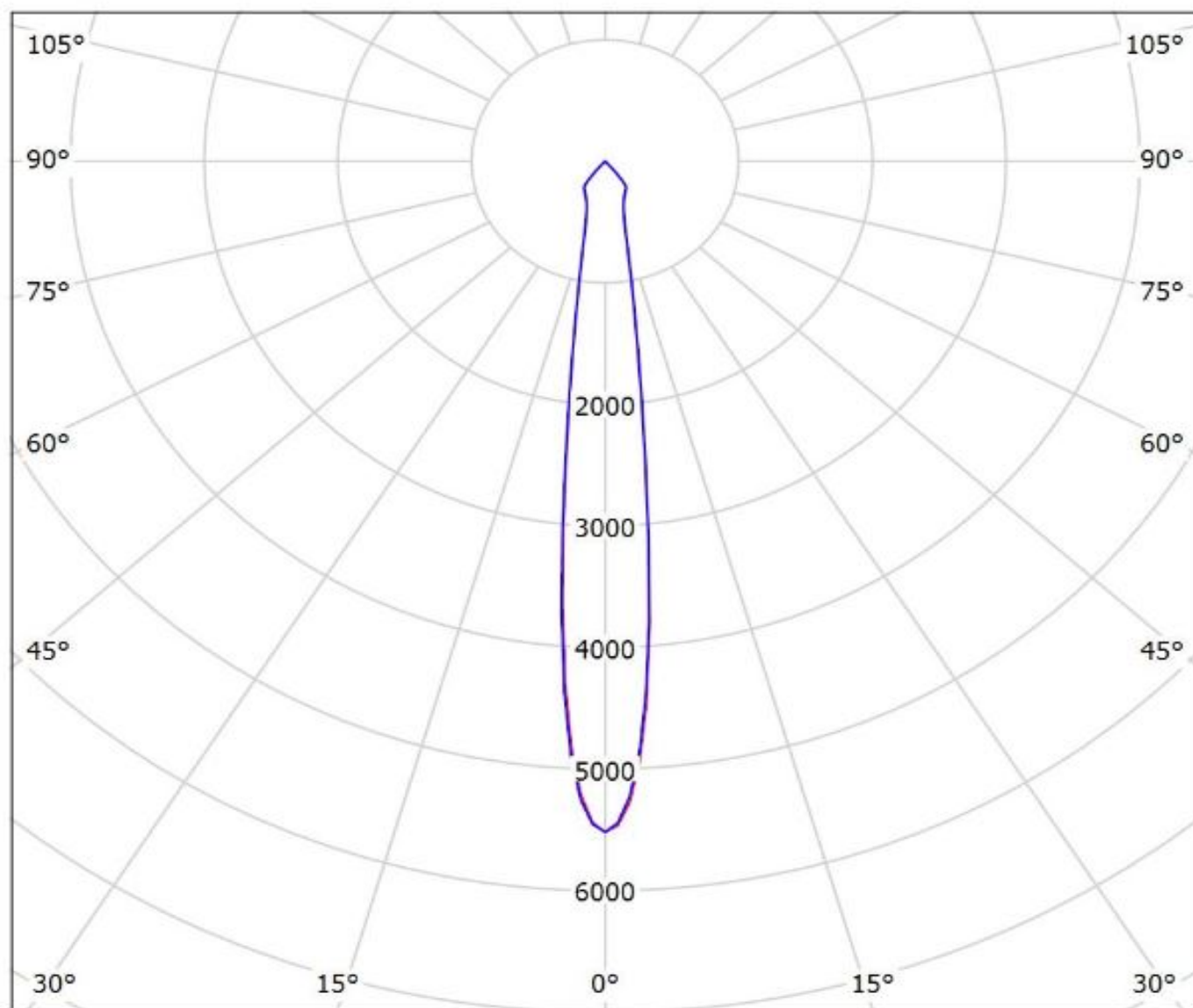

cd/klm

— C0 - C180 — C90 - C270

$\eta = 79\%$

Luminaire: Ledil F14619_ ANGELETTE-S-PLAIN_(CoB1211+IDEAL)

Lamps: 1 x Luxeon_CoB1211_(L2C2-4080)_50-2204CT+50-

2100AN_1376.18lm@250mA_P=7.9988W_I=0.25A

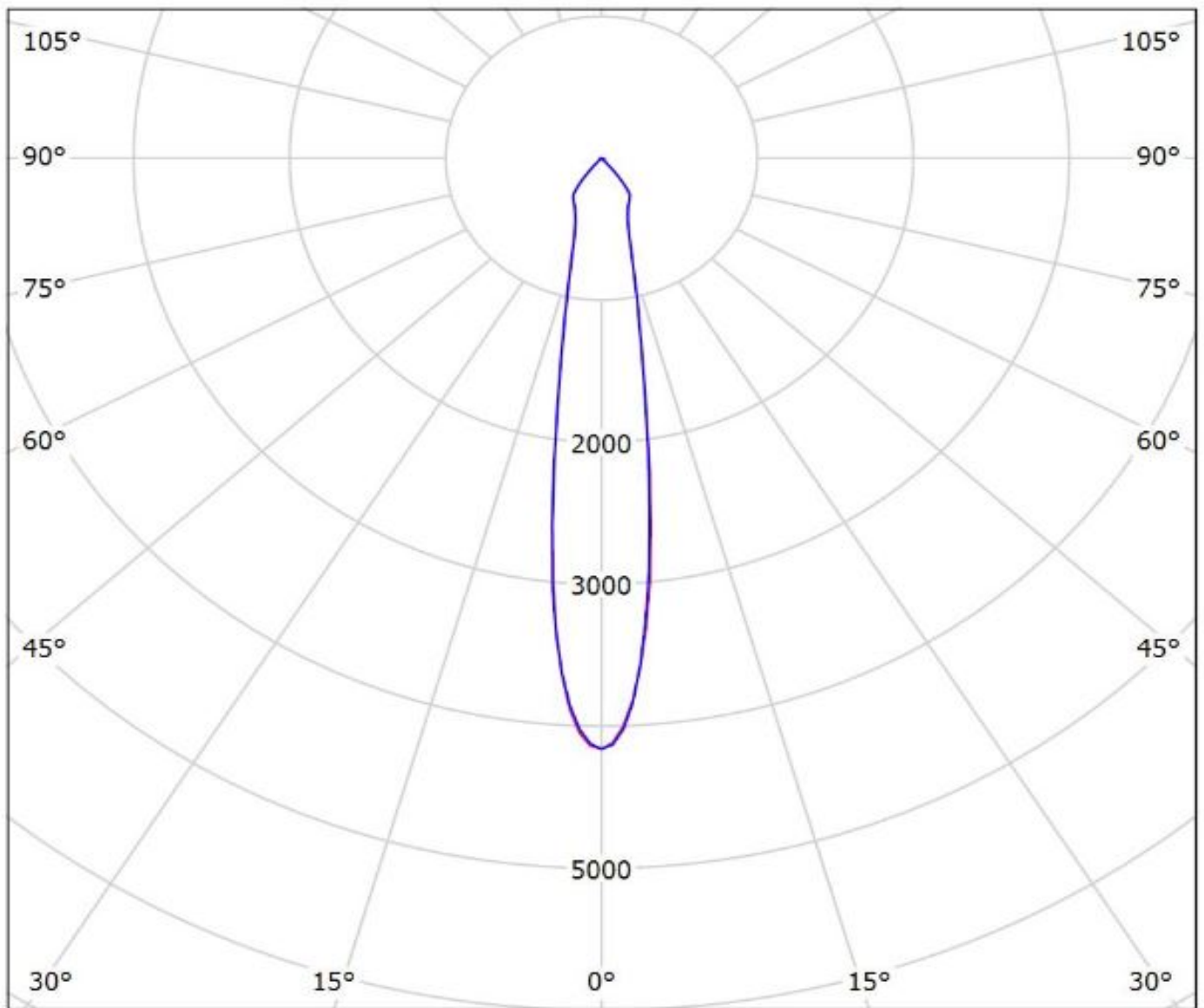

cd/klm

— C0 - C180 — C90 - C270

$\eta = 89\%$

Luminaire: Ledil F14619_ANGELETTE-S-PLAIN_(CoB1216_IDEAL)
Lamps: 1 x Luxeon_CoB1216_(L2C2-40801216E2300)_+50-2204C_+_50-2100AN_1447.57lm@250mA_CCT=4000K_P=8.0135W_I=0.25A

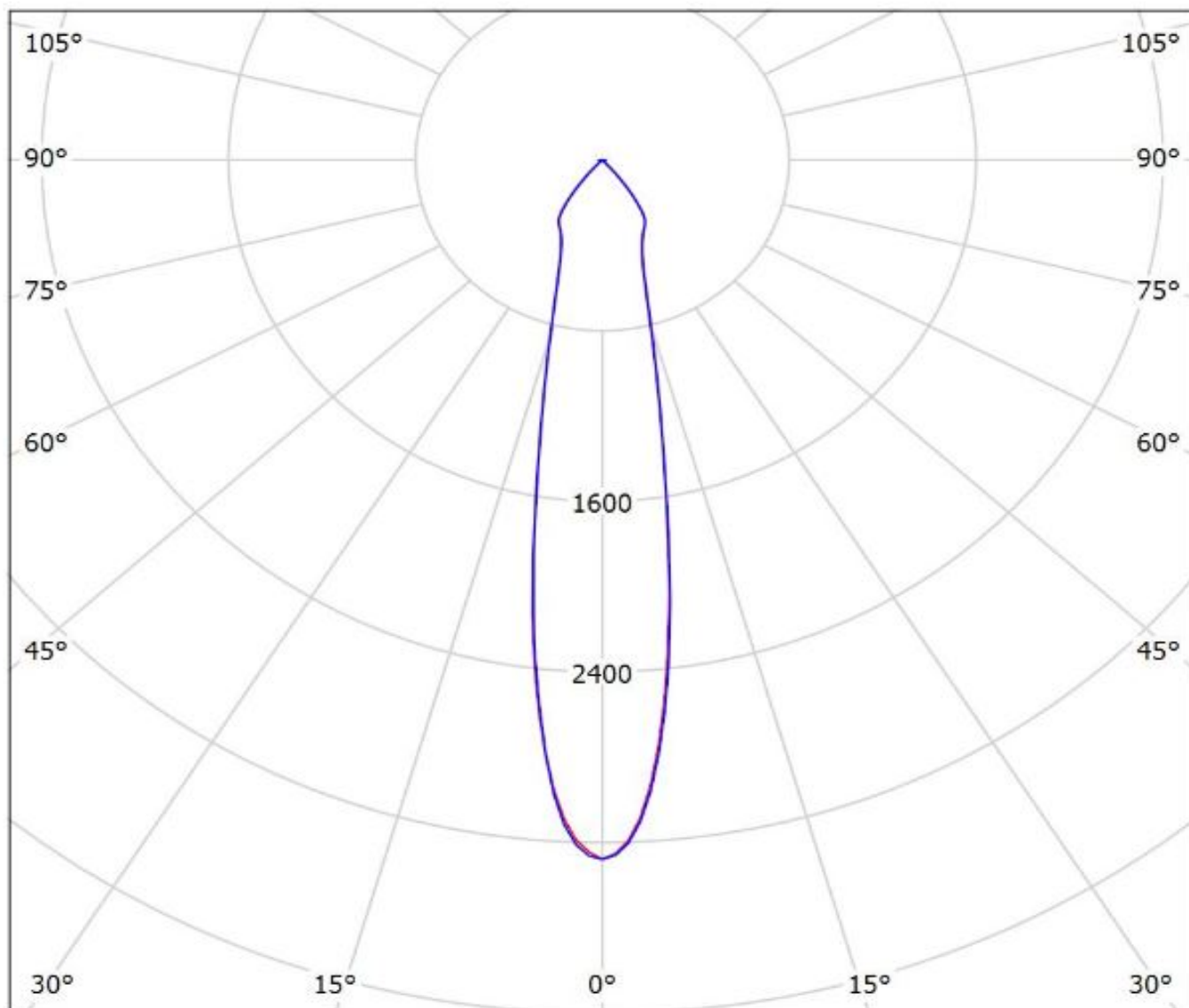

cd/klm

— C0 - C180 — C90 - C270

$\eta = 89\%$

Luminaire: Ledil F14619_ANGELETTE-S-PLAIN_(NVCLL024Z+IDEAL)

Lamps: 1 x Nichia_NVCxL024z_(NVCLL024z)_975.455lm@250mA_P=8.1468W_I=250A

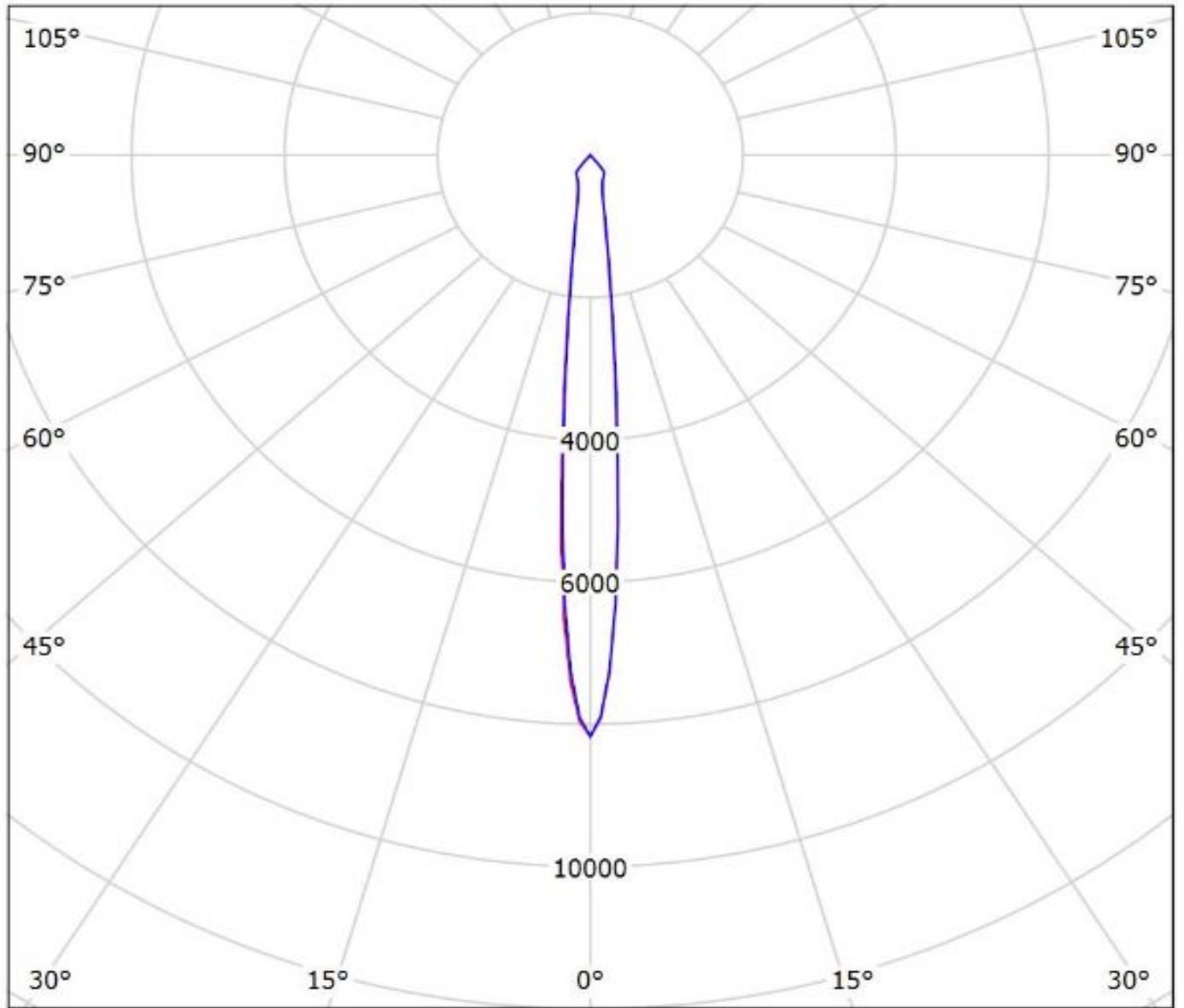

cd/klm

— C0 - C180

— C90 - C270

$\eta = 89\%$

Luminaire: Ledil F14619_ANGELETTE-S-PLAIN_(NVCLL024Z+TE)

Lamps: 1 x Nichia_NVCLL024Z_+2213382-2_+2213194-

1_971.485lm@250mA_CCT=3000K_P=8W_I=0.25A

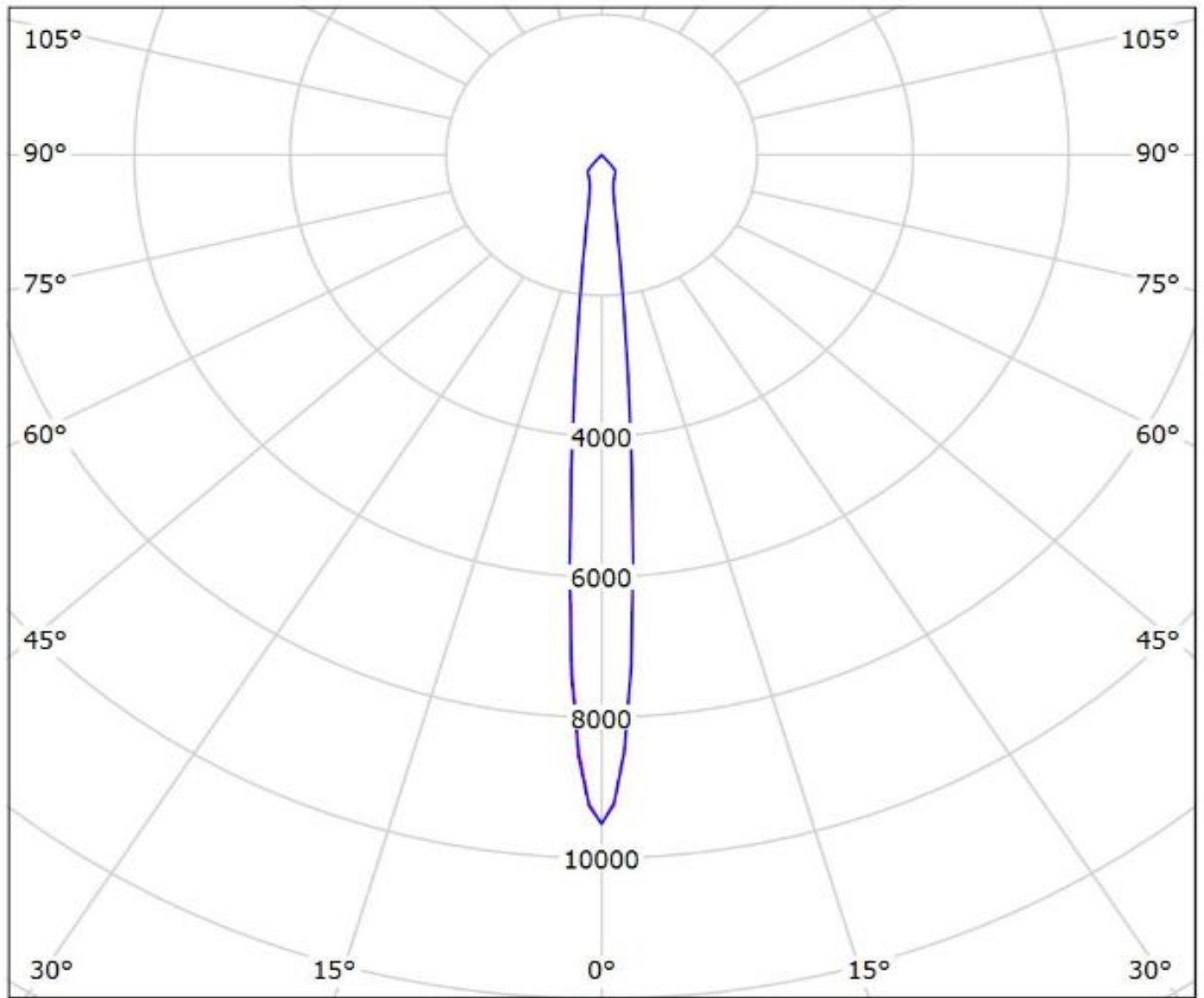

cd/klm

— C0 - C180

— C90 - C270

$\eta = 90\%$

Luminaire: Ledil F14619_ANGELETTE-S-PLAIN_(PREVALED_Core_Z4)
Lamps: 1 x PREVALED_Core_Z4_LES19_1470.62lm@250mA_P=10.828W_I=0.25A

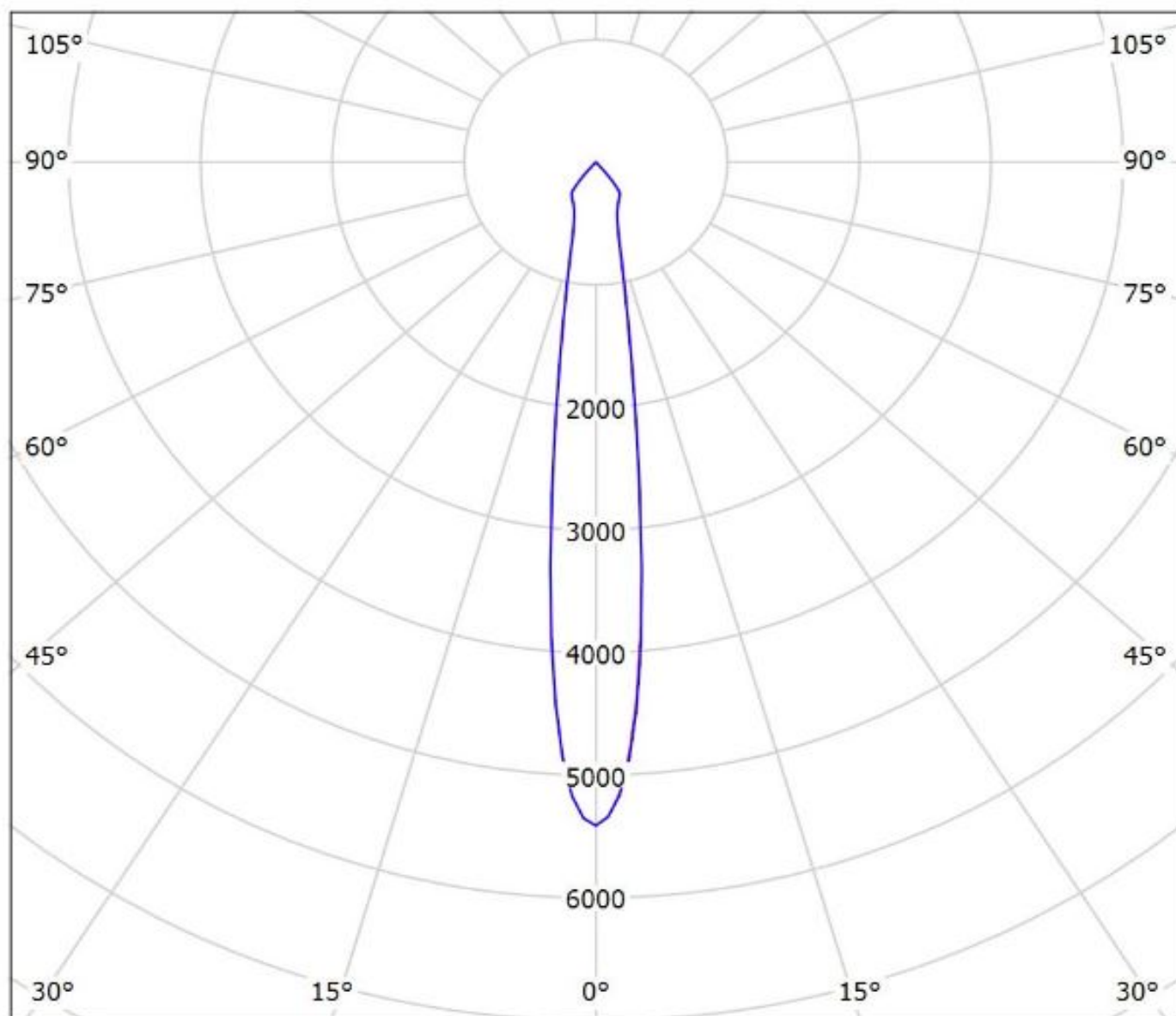

cd/klm
— C0 - C180 — C90 - C270

$\eta = 90\%$

Luminaire: Ledil F14619_ANGELETTE-S-PLAIN_(S19+TE)
Lamps: 1 x Osram_Soleriq_S19_(GW_KAHJB1.EM)_+2213407-2+2213194-1_1546.1lm@250mA_CCT=3000K_P=11.021W_I=0.25A

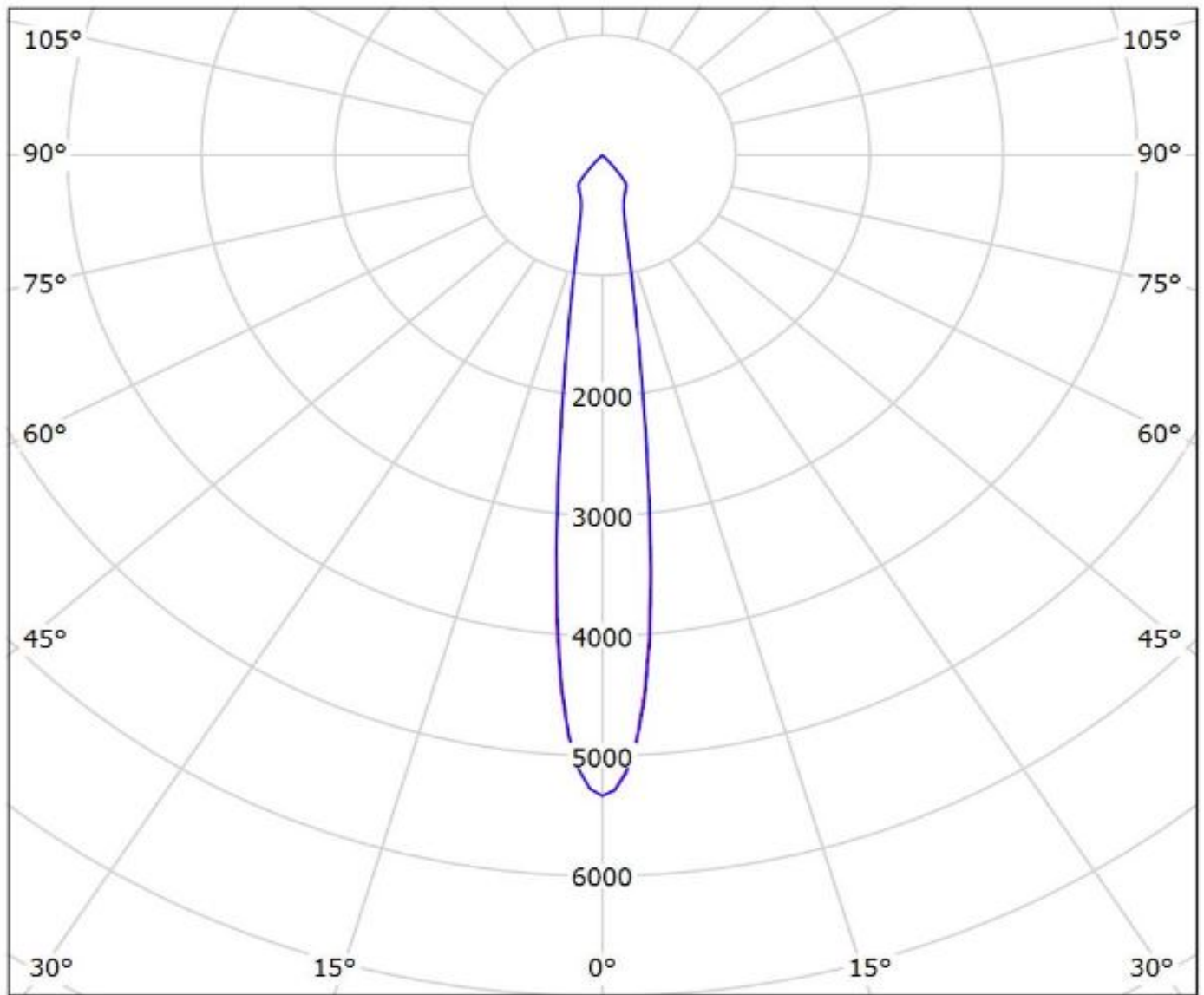

cd/klm
— C0 - C180 — C90 - C270

$\eta = 90\%$

Luminaire: Ledil F14619_ANGELETTE-S-PLAIN_(S13_Gen2+TE)

Lamps: 1 x Soleriq_S13_Gen2+_2213254-2+_2213194-1_1309.23lm@250mA_P=8.7840W_I=0.250A

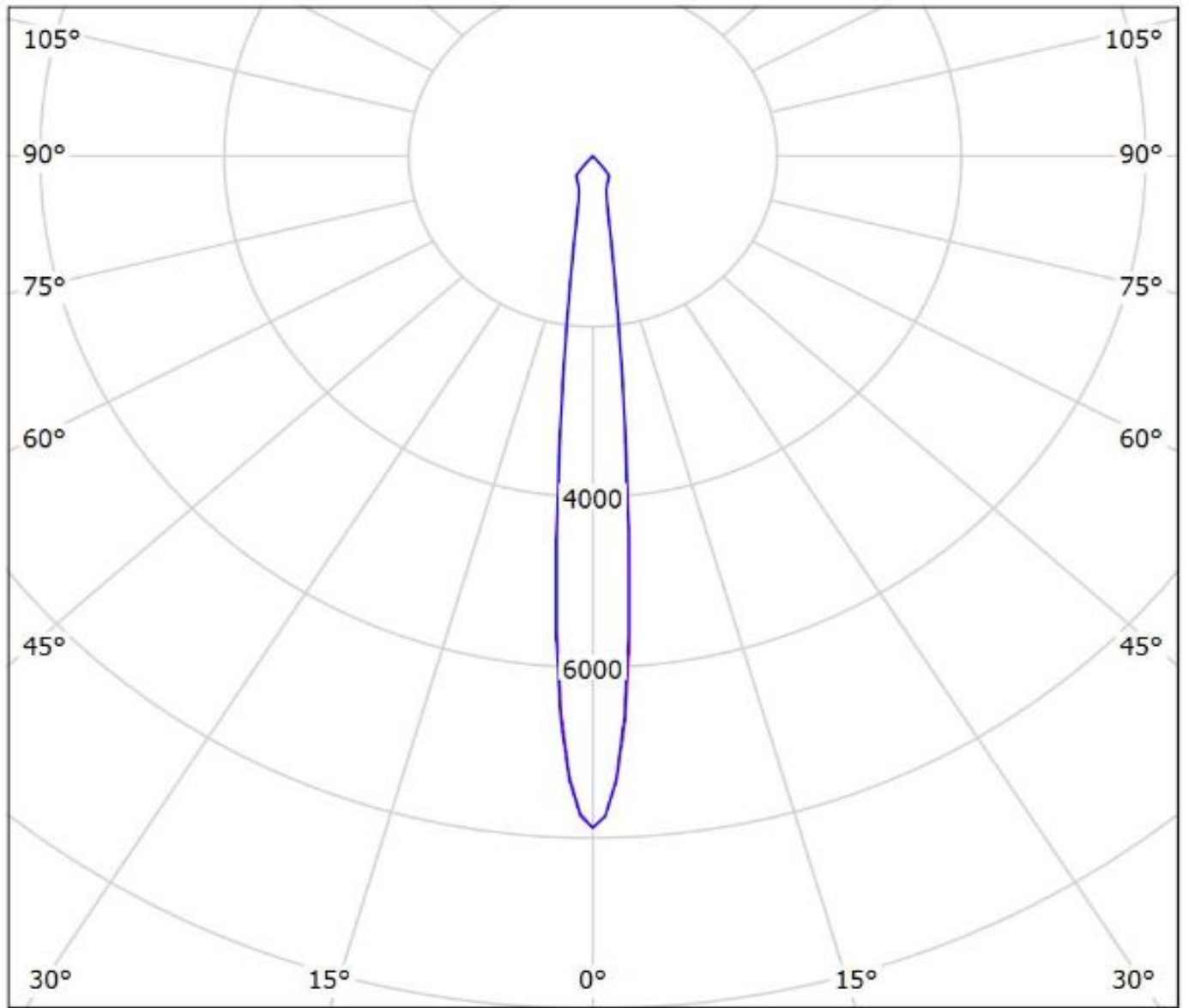

cd/klm
— C0 - C180 — C90 - C270

$\eta = 89\%$

Luminaire: Ledil F14619_ANGELETTE-S-PLAIN_(SLM_G5_LES_15_+TE)

Lamps: 1 x Philips_SLM_G5_LES_15_+TE_2213194-1_1277.72lm@250mA_P=8.208W_I=0.25A

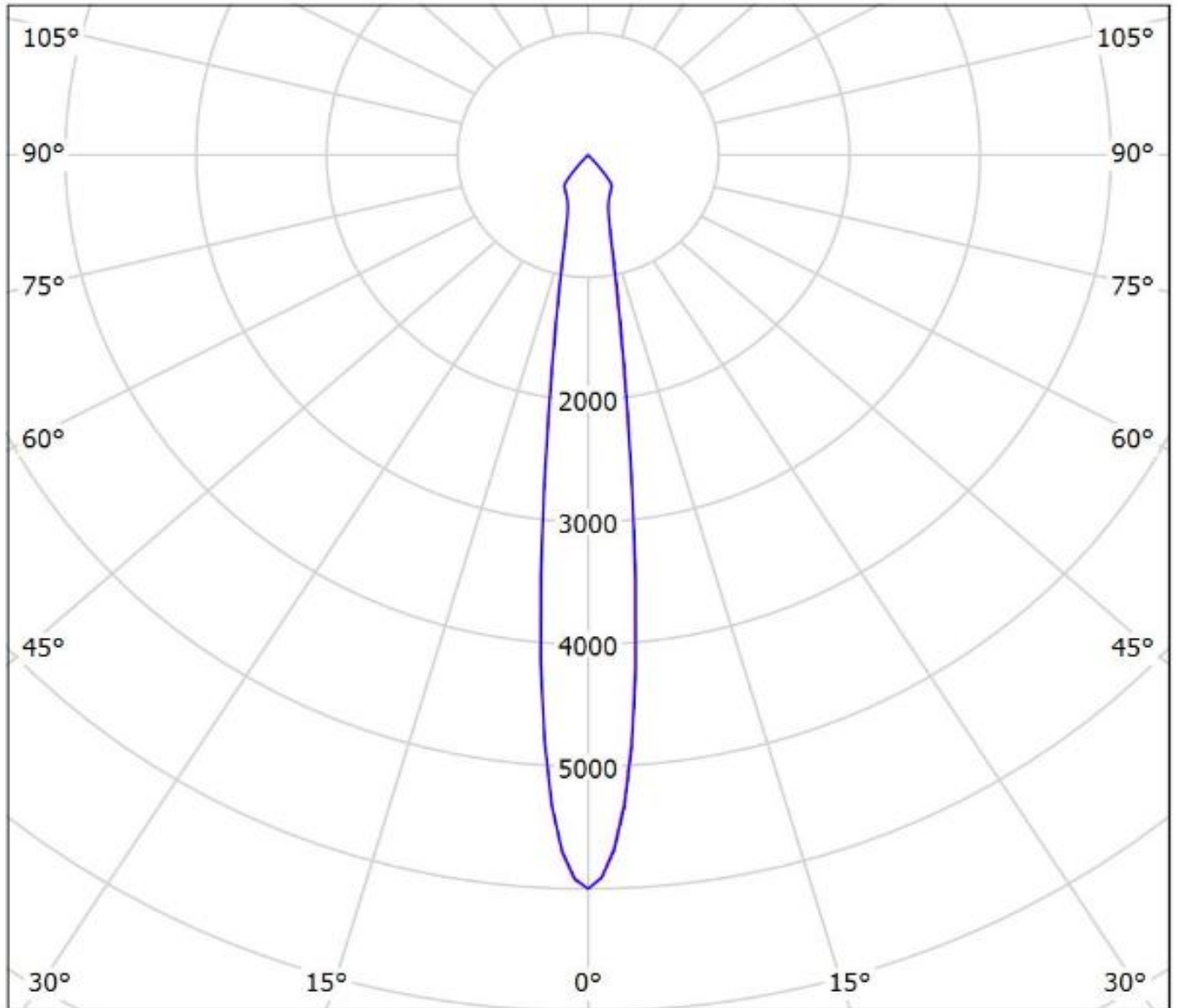

cd/klm

— C0 - C180 — C90 - C270

$\eta = 89\%$

Luminaire: Ledil F14619_ ANGELETTE-S-PLAIN_(LC040C+TE)

Lamps: 1 x Samsung_LC040C+_2213382-2+_2213194-1_1194.16lm@250mA_CCT=4000K_P=8.137W

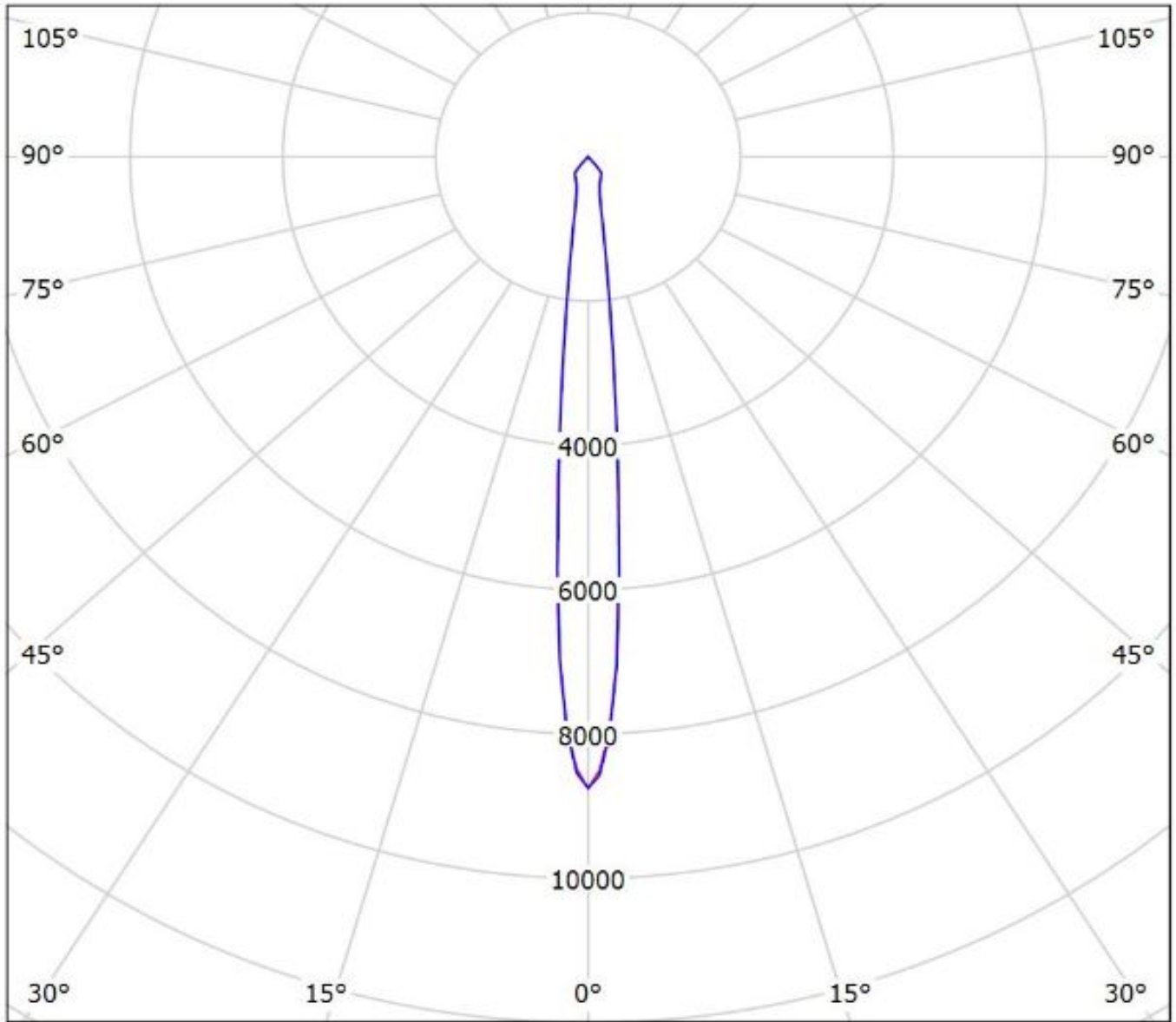

cd/klm

— C0 - C180

— C90 - C270

$\eta = 90\%$

Luminaire: Ledil F14619_ANGELETTE-S-PLAIN_(SEOUL_AC_Zhaga_COB)
Lamps: 1 x SEOUL_AC_Zhaga_COB

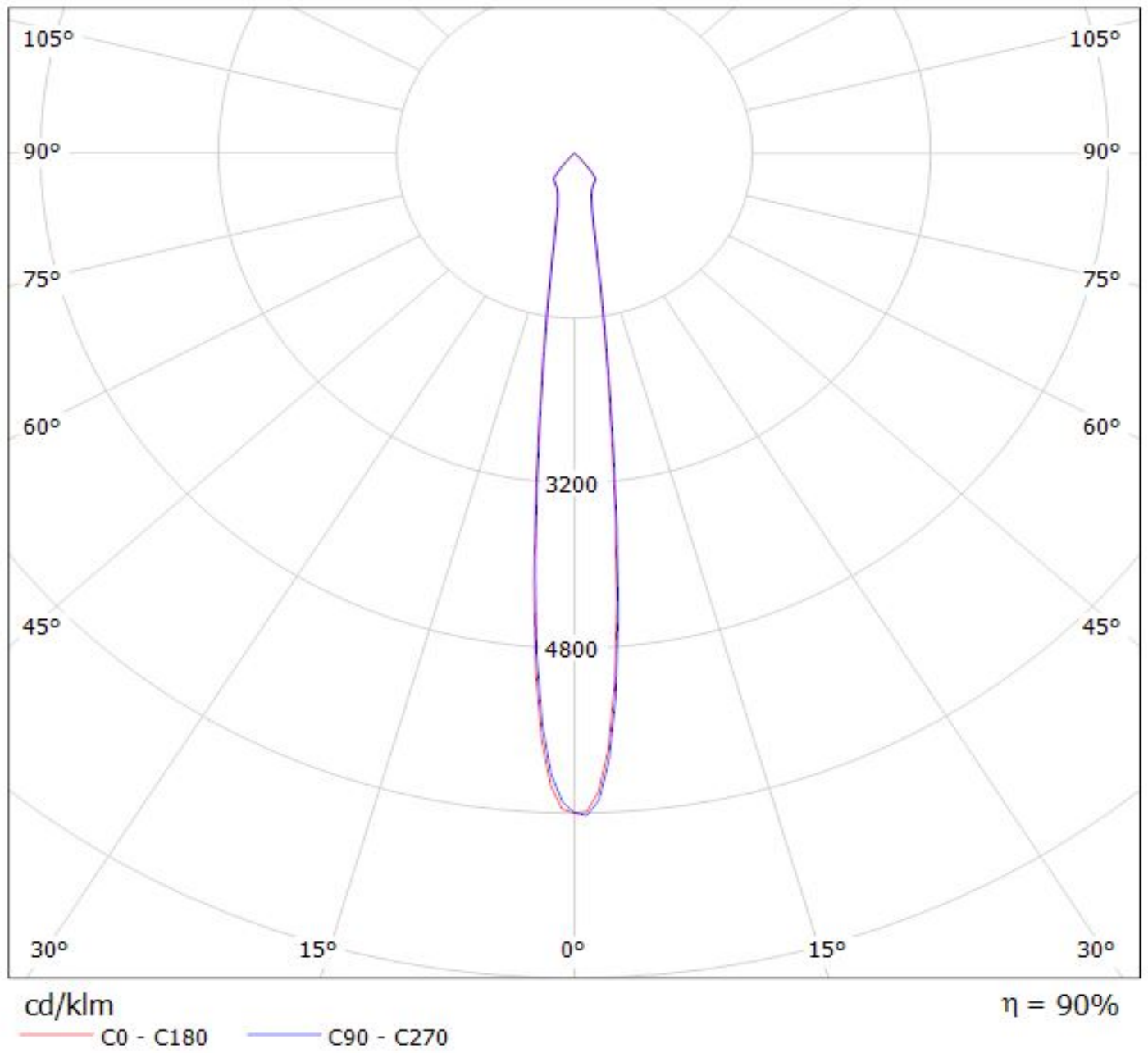

Luminaire: Ledil F14619_ANGELETTE-S-PLAIN_(WU-M-484+TE)

Lamps: 1 x Vossloh_Schwabe_WU-M-484-830_681.21lm@250mA_P=5.6195W_I=0.25A

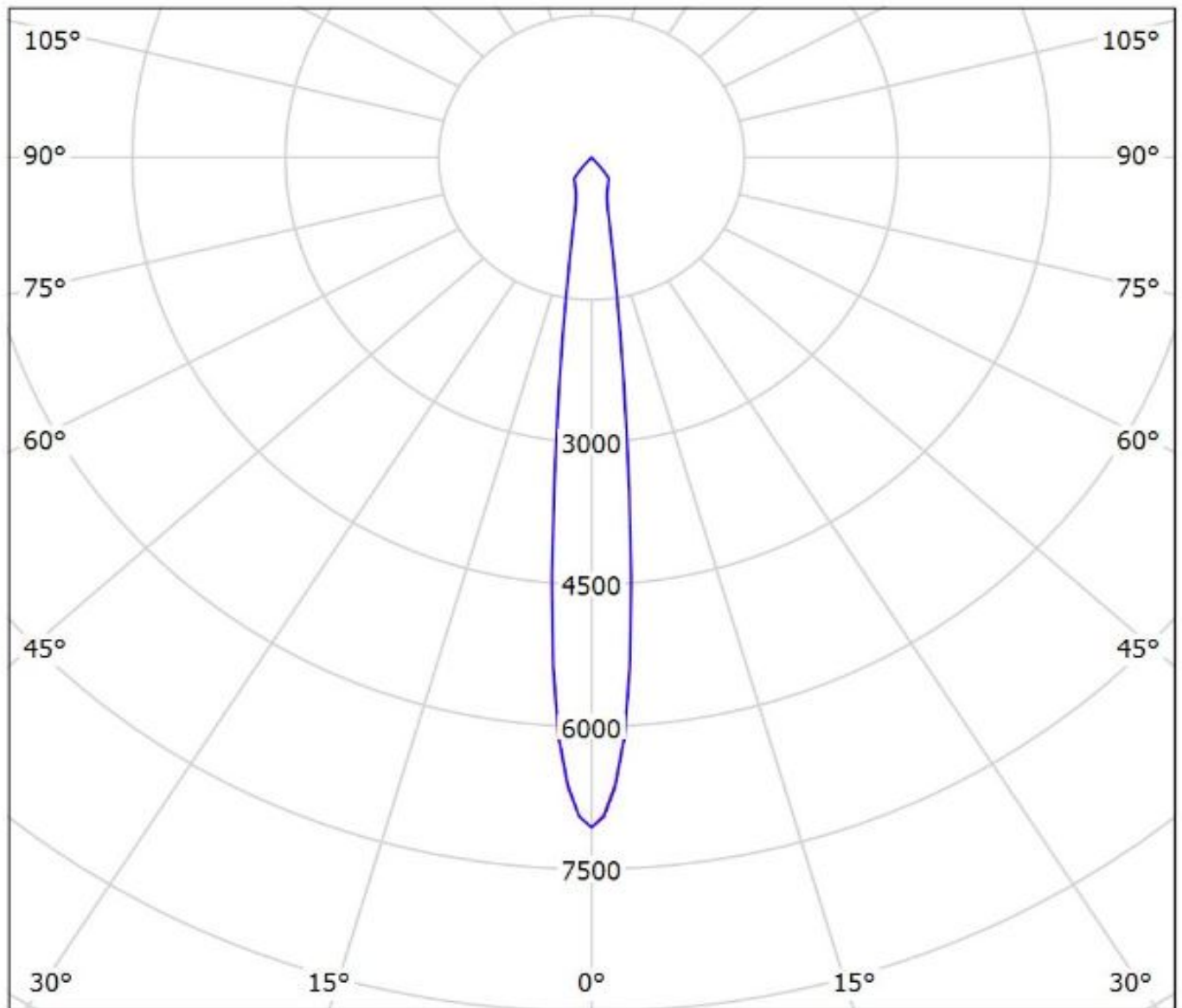

cd/klm

— C0 - C180

— C90 - C270

$\eta = 89\%$

NOTE: The typical divergence will be changed by different color, chip size and chip position tolerance. The typical total divergence is the full angle measured where the luminous intensity is half of the peak value.

GENERAL INFORMATION

- Product series especially designed & optimized for series of LEDs.
- Special care taken to make light distribution as uniform as possible.

Note! Due to use of high power COB's with this product, special attention to proper thermal design is highly recommended. LEDiL has no liability for direct, indirect or consecutive damages arising from the LEDiL products being used outside of the recommended temperature range.